



TAOGLAS®



Datasheet

Stingray Low Profile Adhesive Mount GPS-GLONASS-GALILEO Antenna

Part No:
AA.107.301111

Features:

GNSS Antenna covering 1575.42/1602MHz

Low Profile, Robust ABS Enclosure

Cable: 3m RG-174

Connector: SMA(M)

IP65 Waterproof Rating

Dimensions: 55 * 51.7 * 10.8mm

RoHS Compliant

1.	Introduction	3
2.	Specifications	4
3.	Antenna Characteristics	6
4.	Radiation Patterns	9
5.	Mechanical Drawing	11
6.	Packaging	12
<hr/>		
	Changelog	13

Taoglas makes no warranties based on the accuracy or completeness of the contents of this document and reserves the right to make changes to specifications and product descriptions at any time without notice. Taoglas reserves all rights to this document and the information contained herein. Reproduction, use or disclosure to third parties without express permission is strictly prohibited.



1. Introduction



The Taoglas Stingray AA107 is a low profile adhesive mount GNSS antenna. It is designed for applications which require high positioning accuracy by combining signals from GPS, GLONASS and Galileo systems. A high gain wide-band patch antenna on an integral ground delivers reliable performance, ideal for those applications that require durability, small size and covert installation, and reliable reception and transmission crossing through different mobile networks.

The high- quality, low profile covert housing is just 10.8mm in height and for in-vehicle GNSS systems, it can be attached onto glass windscreens or even out of sight under the dashboard. The standard version comes with 3 metres of RG174 cable and an SMA(M) connector. The cables and connectors are completely customizable. Please contact your local Taoglas customers services team for further information.

2. Specifications

GNSS Frequency Bands Covered							
GPS/QZSS	L1 1575.42MHz	L2 1227.6MHz	L5 1176.45MHz	L6 1278.75MHz			
	■	□	□	□			
GLONASS	L5R 1176.45MHz	L3PT 1201.5MHz	L2PT 1246MHz	L1CR 1575.42MHz	L1PT 1602MHz		
	□	□	□	■	■		
Galileo	E5a 1176.45MHz	E5b 1201.5MHz	E4 1215MHz	E3 1256MHz	E6 1278.75MHz	E2 1561MHz	L1 1575.42MHz
	□	□	□	□	□	□	■
BeiDou	B1 1561MHz	B2 1207.14MHz	B3 1268.52MHz				
	□	□	□				
Compass	E5B(B2)/ E6(B3) 1268.56MHz	E2(B1) 1561MHz					
	□	□					
SBAS	Omnistar 1542.5MHz	WAAS/EGN OS 1575.42MHz					
	□	■					

GNSS Electrical		
Centre Frequency (MHz)	GPS/GALILEO: 1574.42MHz ±3MHz	GLONASS: 1602MHz ±0.5MHz
Peak Gain (dBi)	1.36	0.09
Efficiency (%)	50.13	52.64
LNA Gain at 3.3V	28dB Typ.	
VSWR	2.0:1	
Impedance	50Ω	
Recommended power input	3.3V	
Acceptable power input range	3-5V	
Noise Figure	2.2dB Typ.	
Power Consumption	10mA Typ.	

Mechanical	
Antenna Dimensions	55 x 51.7 x 10.8mm
Housing Material	UV Resistant ABS
Cable	3m RG174
Connector	SMA(M)
Environmental	
Operation Temperature	-40°C to 85°C
Storage Temperature	-40°C to 85°C
Relative Humidity	40% to 95%

3. Antenna Characteristics

3.1 Return Loss

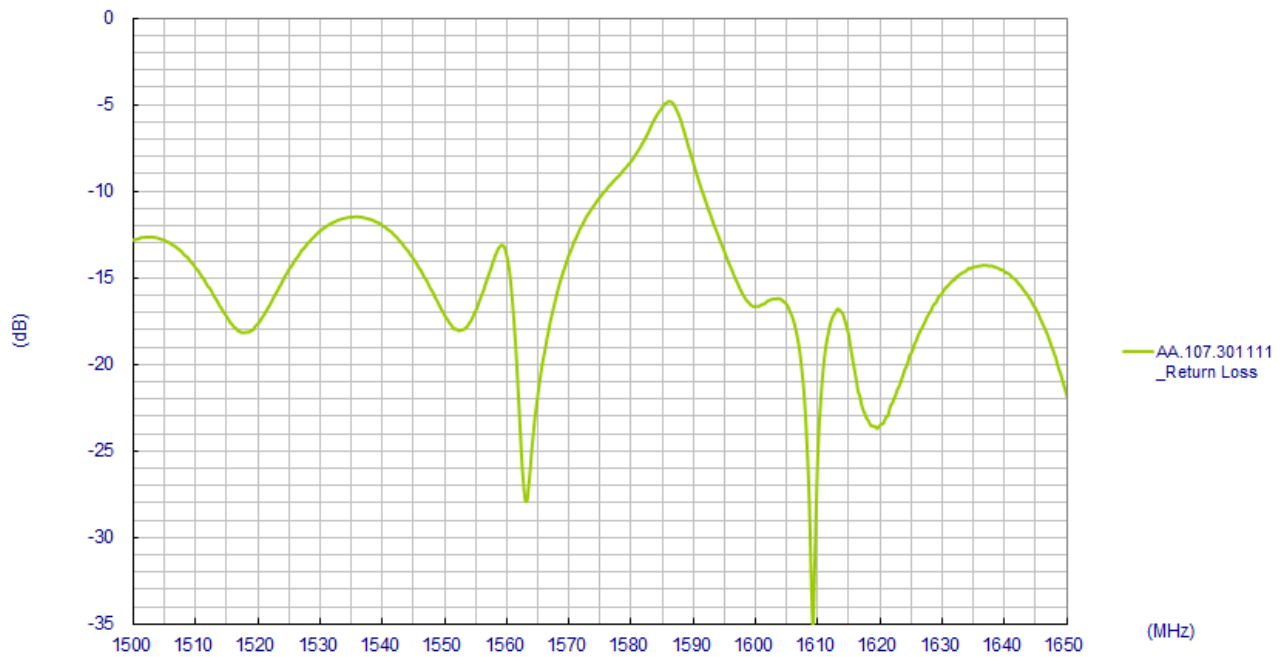

3.2 VSWR

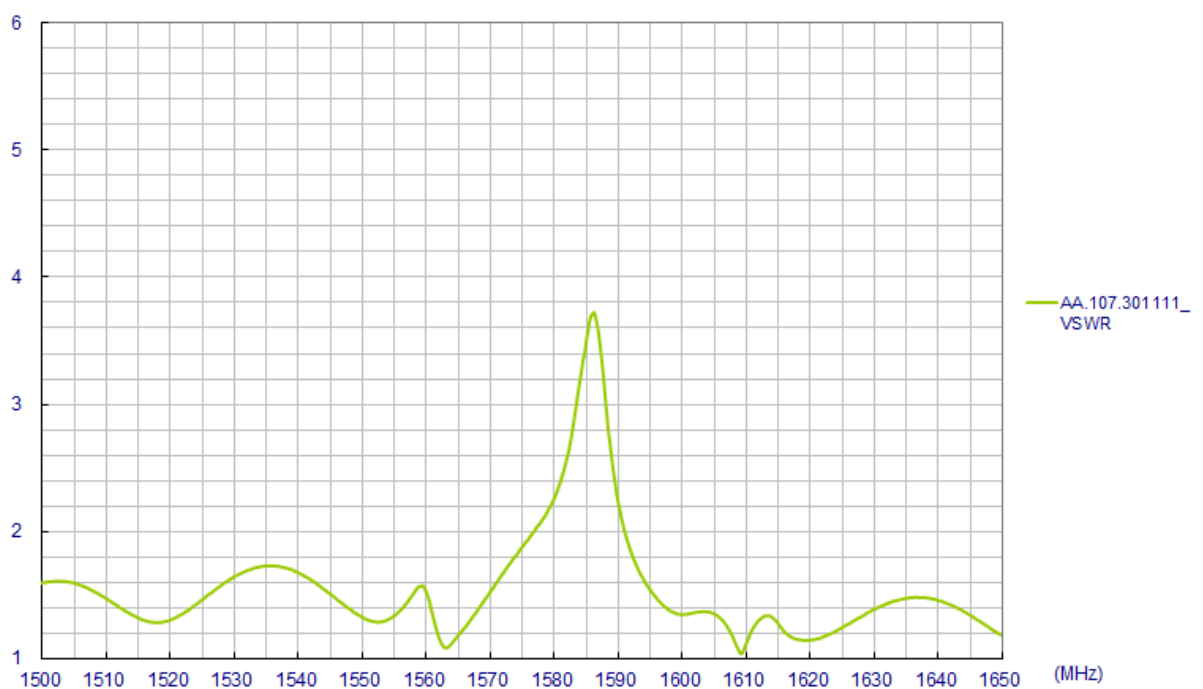

3.3 Smith Chart - Impedance

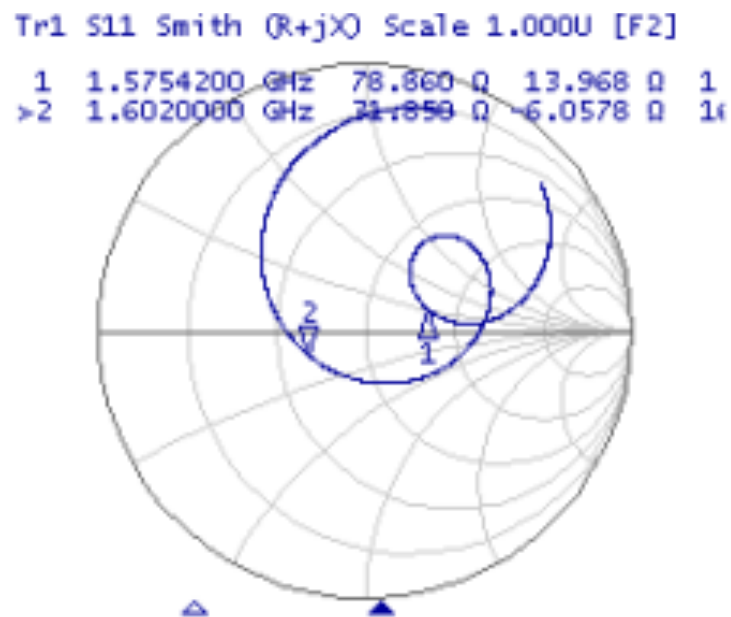

3.4 Antenna Block Diagram

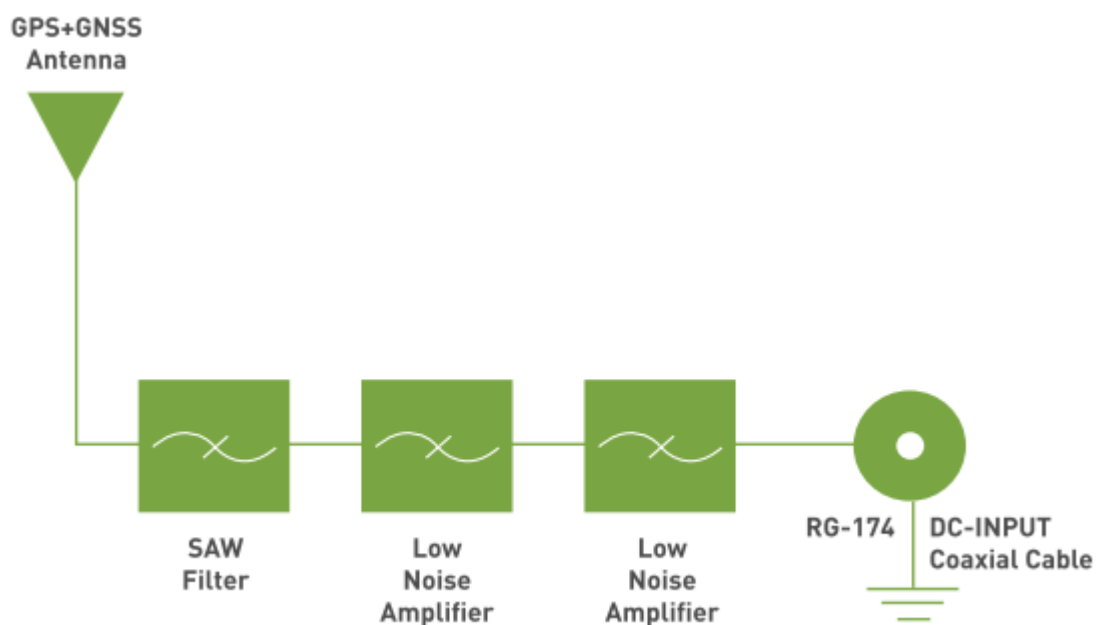

3.5 GPS/GLONASS/GALILEO LNA Gain

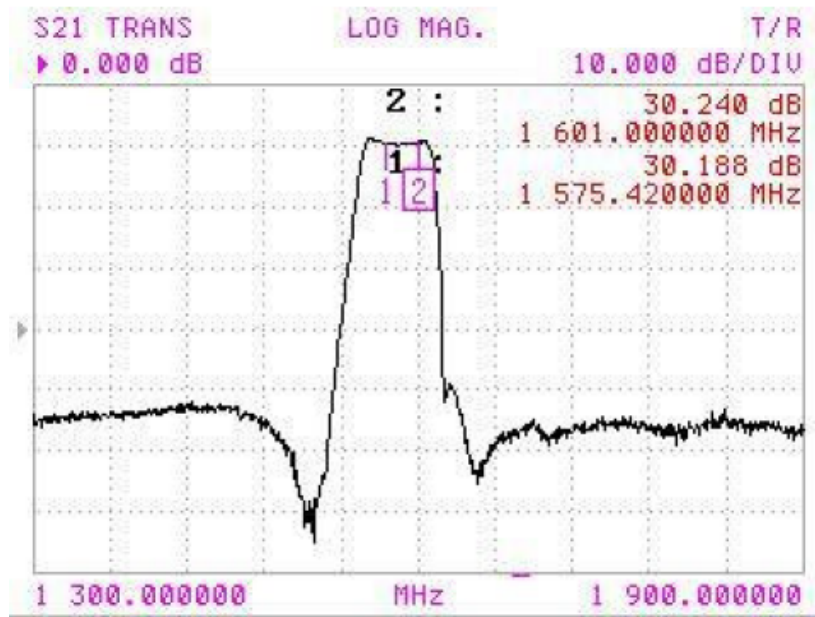

3.6 GPS/GLONASS/GALILEO LNA Output Return Loss

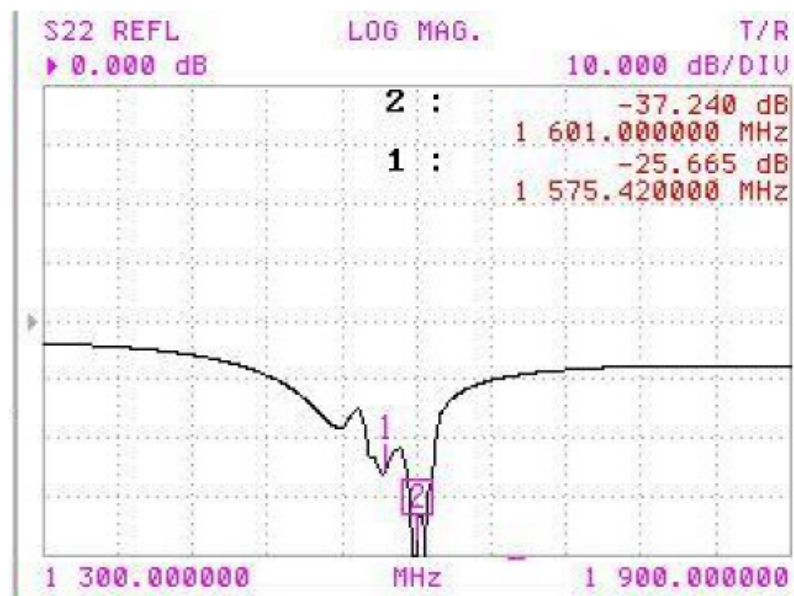

4. Radiation Patterns

4.1 Test Setup

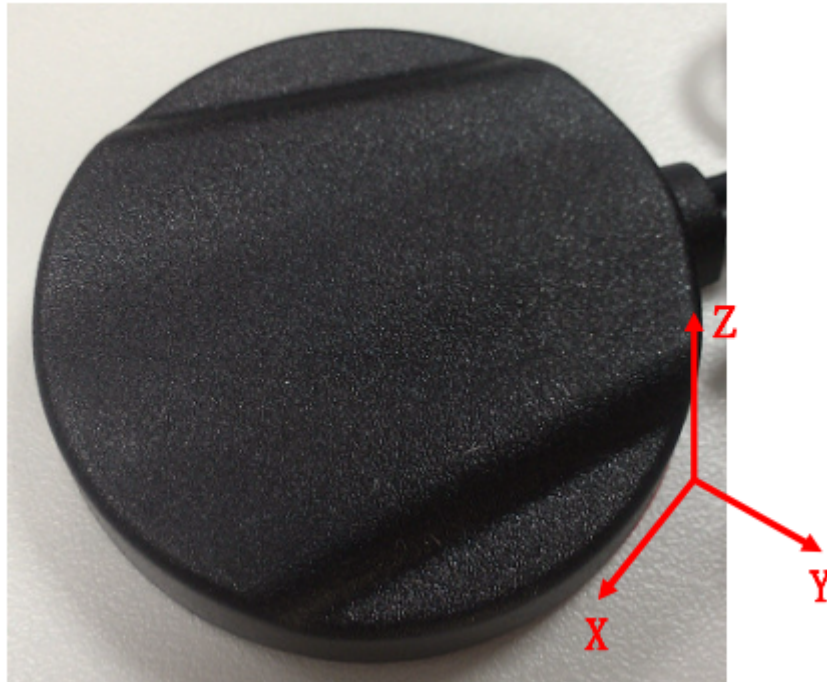

4.2 1575MHz

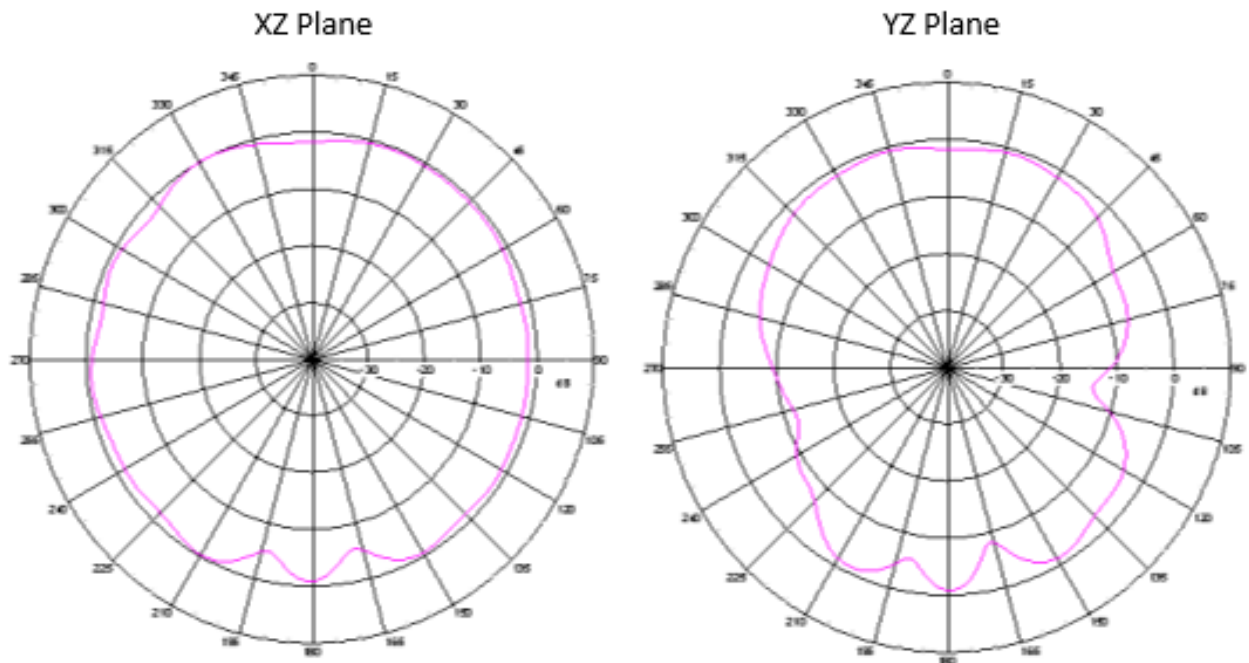

4.3 1602MHz

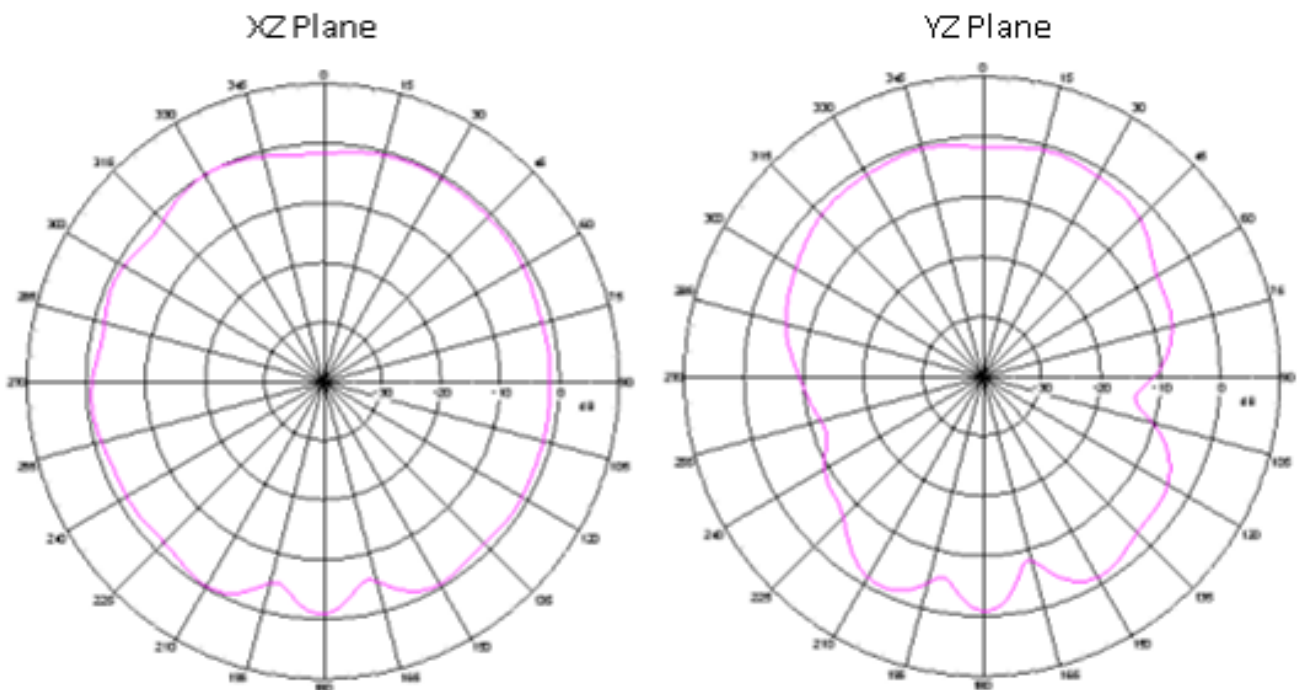

5. Mechanical Drawing (Units: mm)

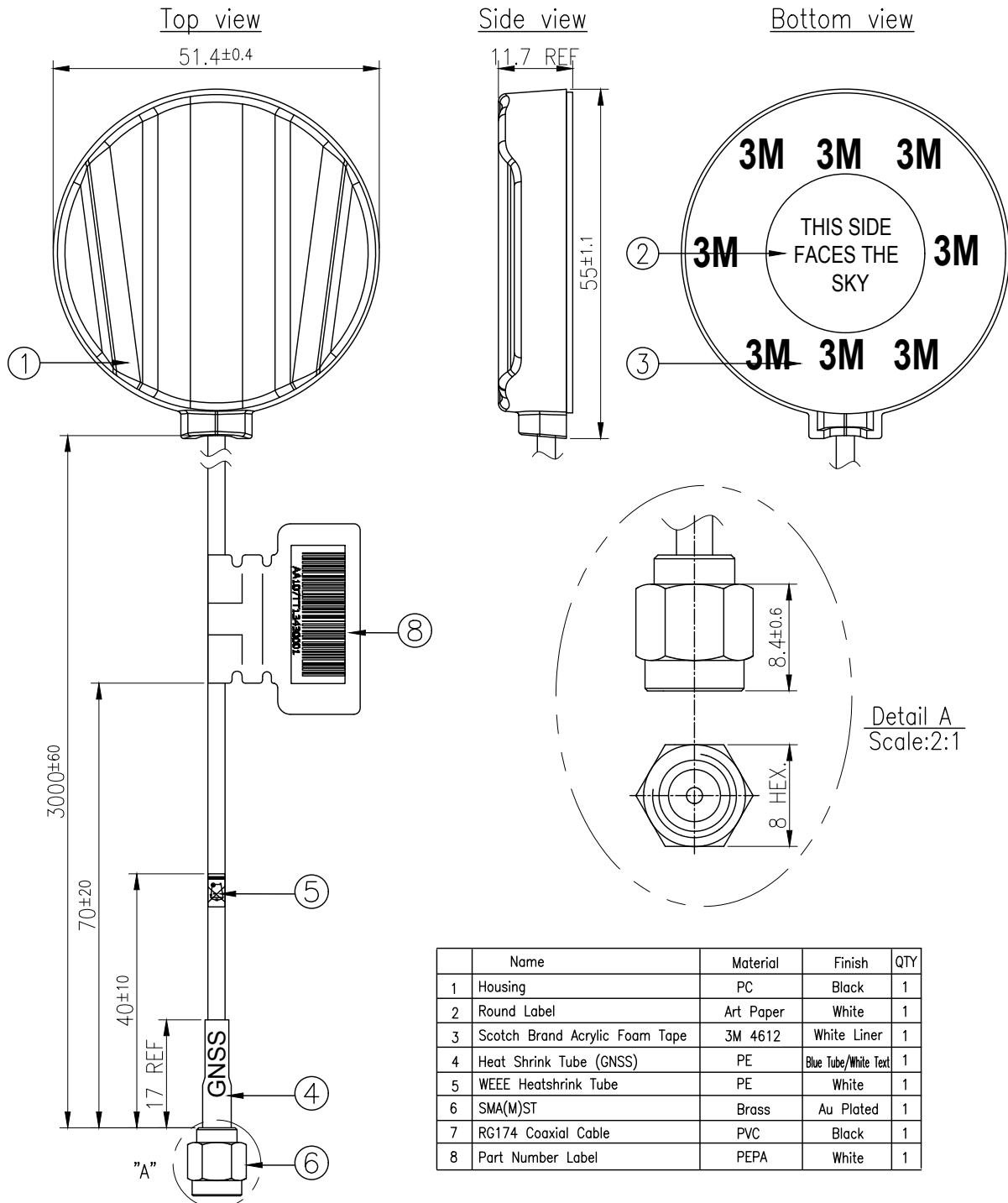

6. Packaging

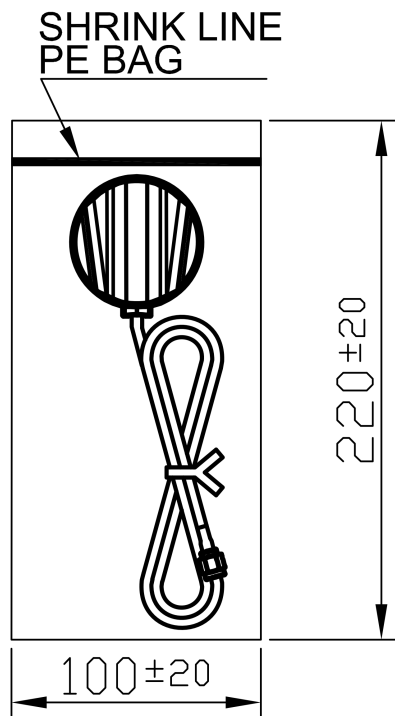

PACKING:1PCS/BAG

Changelog for the datasheet

SPE-13-8-038-D - AA.107.30111

Revision: D (Current Version)

Date:	2021-07-19
Changes:	Full datasheet template update & added 'Acceptable power input range - 3-5V' to table. Drawing updated.
Changes Made by:	Gary West

Previous Revisions

Revision: C

Date:	2017-03-24
Changes:	
Changes Made by:	Wayne Yang

Revision: B

Date:	2013-05-17
Changes:	Updated with return loss & VSWR charts from Wayne
Changes Made by:	Aine Doyle

Revision: A (Original First Release)

Date:	2013-05-13
Notes:	
Author:	Wayne Yang

Previous Revisions (Continued)



TAOGLAS®

www.taoglas.com

