



# TAOGLAS®



# Datasheet

## MagmaX

**Part No:**  
AA.171.301111

### Description:

MagmaX IP67 GPS/QZSS (L1), Galileo (E1), GLONASS (G1), BeiDou (B1)  
External Automotive Antenna 3M RG-174 SMA(M)-SAW Filter

### Features:

Magnetic Mount  
Low Axial Ratio, less than 3

Covers:

- GPS/QZSS (L1)
- Galileo (E1)
- GLONASS (G1)
- BeiDou (B1)

Cable: 3m RG-174

Connector: SMA(M)

First Tier Automotive TS16949 Approved

Dimensions: 53mm\*50mm\*17mm

CE Certified

RoHS & Reach Compliant



1. Introduction	3
2. Specifications	4
3. Antenna Characteristics	7
4. Radiation Patterns	11
5. Active Characteristics	19
6. Field Test Results	21
7. Pull Force Test	22
8. Mechanical Drawing	24
9. Packaging	25
<hr/>	
Changelog	26

Taoglas makes no warranties based on the accuracy or completeness of the contents of this document and reserves the right to make changes to specifications and product descriptions at any time without notice. Taoglas reserves all rights to this document and the information contained herein. Reproduction, use or disclosure to third parties without express permission is strictly prohibited.



## 1. Introduction



The AA.171 MagmaX Low Axial Ratio Magma magnetic mount external GNSS antenna is ideal for robust, covert installations where durability and small size is paramount. It is used in telematics and M2M applications, for example in commercial vehicle installations for fleet management.

Typical Applications Include:

- Timing
- Precision Positioning for Robotics / Automotive
- Telematics
- Autonomous Routing

Standard cable and connector version is 3 meter RG174 and SMA(M). Cable length and connector type are customizable upon request.

Using a unique specialist feed structure this antenna delivers best in class axial ratio across all GPS, GLONASS, Galileo and BeiDou bands. Low axial ratio improves accuracy of GNSS system location and leads to quicker lock times. A front-end SAW reduces out-band interference from any nearby wireless transmitters, helping prevent LNA compression and burnout. Manufactured in a dedicated TS16949 facility, PPAP and IMDS documentation are available on request. Low power consumption lengthens device battery life. Adhesive mount version is available on request.

The cable and connector is fully customizable, contact your regional Taoglas customer support team for further information.

## 2. Specifications

GNSS Frequency Bands Covered						
GPS	L1	L2	L5			
	■	□	□			
GLONASS	G1	G2	G3			
	■	□	□			
Galileo	E1	E5a	E5b	E6		
	■	□	□	□		
BeiDou	B1	B2a	B2b	B3		
	■	□	□	□		
QZSS (Regional)	L1	L2C	L5	L6		
	■	□	□	□		
IRNSS (Regional)	L5					
	□					
SBAS	L1/E1/B1	L5/B2a/E5a	G1	G2	G3	
	■	□	■	□	□	

■ GNSS Frequency Bands Covered. □ GNSS Frequency Bands Not Covered.

\*SBAS systems: WASS(L1/L5), EGNOS(E1/E5a), SDCM(G1/G2/G3), SNAS(B1,B2a), GAGAN(L1/L5), QZSS(L1/L5), KAZZ(L1/L5).

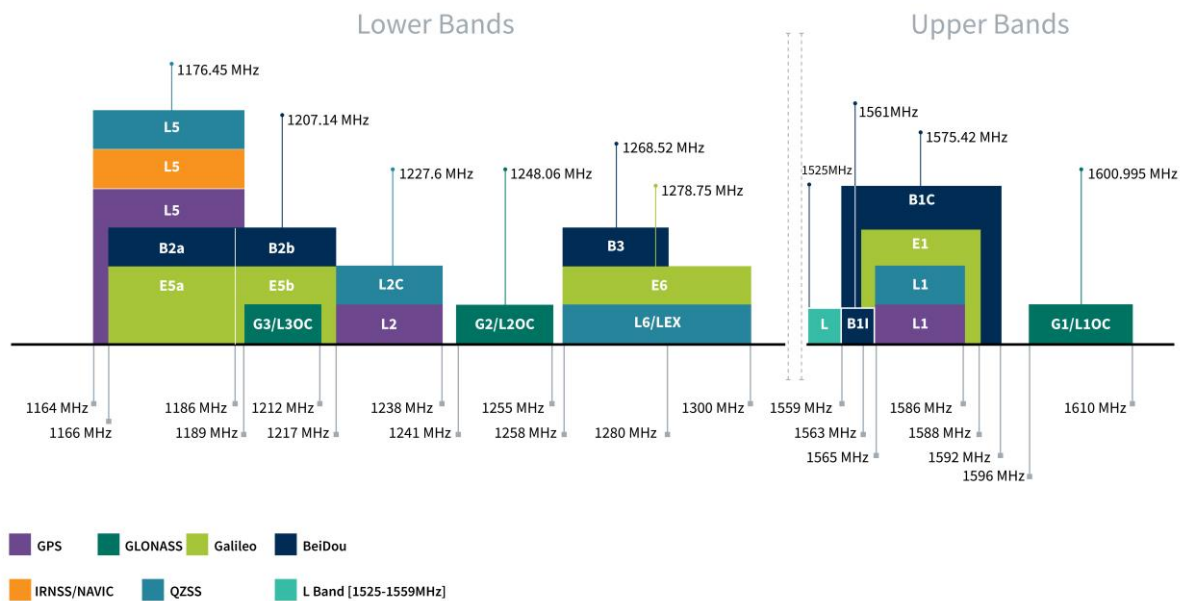

GNSS Bands and Constellations

GNSS Electrical			
Frequency (MHz)	BeiDou	GPS/Galileo	GLONASS
	1559~ 1563	1563~ 1587	1593~ 1610
Efficiency (%)			
on 30x30cm ground plane	47.5	46.8	33.7
Average Gain (dB)			
on 30x30cm ground plane	-3.2	-3.3	-4.7
Peak Gain (dBi)			
on 30x30cm ground plane	3.1	2.9	1.2
Axial Ratio (dB) at zenith			
on 30x30cm ground plane	0.5	0.5	1
Group Delay			
on 30x30cm ground plane	7.5	7.5	7.5
PCO (cm)			
on 30x30cm ground plane	1.7	1.7	1.7
PCV (cm)			
on 30x30cm ground plane	2	2	2
Polarization		RHCP	
Return Loss		< -7dB	
Impedance		50 Ω	

LNA and Filter Electrical Properties			
Frequency (MHz)	1561	1575.42	1602
Gain@1.8V (Typ.)	21.14dB	21.36dB	21.01dB
Gain@3.0V (Typ.)	28.49dB	28.79dB	28.53dB
Gain@5.5V (Typ.)	29.86dB	30.18dB	29.9dB
Noise@1.8V (Typ.)	3.04dB	2.78dB	2.88dB
Noise@3.0V (Typ.)	2.83dB	2.51dB	2.73dB
Noise@5.5V (Typ.)	2.89dB	2.52dB	2.76dB
Current@1.8v(mA)	3.06mA		
Current@3v(mA)	7.71mA		
Current@5.5v(mA)	9.13mA		

<b>Mechanical</b>	
<b>Housing Dimensions</b>	53*50*17mm
<b>Housing Material</b>	ABS
<b>Cable</b>	3m RG174 (fully customizable)
<b>Connector</b>	SMA(M) (fully customizable)
<b>Waterproof</b>	IP67
<b>Weight</b>	92g
<b>Magnetic Pull Force</b>	Pull horizontal max pull force(kgf): 0.52 Pull vertical max pull force(kgf): 0.48
<b>Environmental</b>	
<b>Operation Temperature</b>	-40°C ~ +85°C
<b>Storage Temperature</b>	-40°C ~ +90°C
<b>RoHS Compliant</b>	Yes
<b>REACH Compliant</b>	Yes

### 3. Antenna Characteristics

#### 3.1 Return Loss

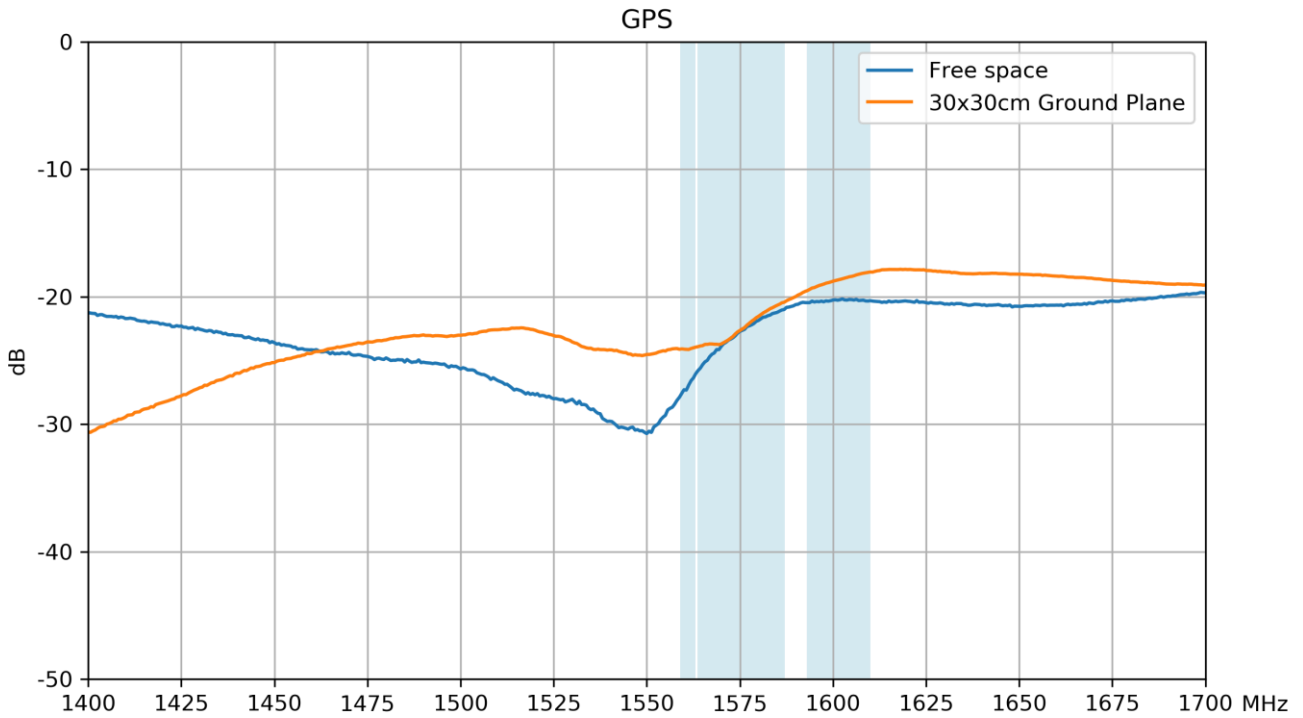

#### 3.2 Efficiency

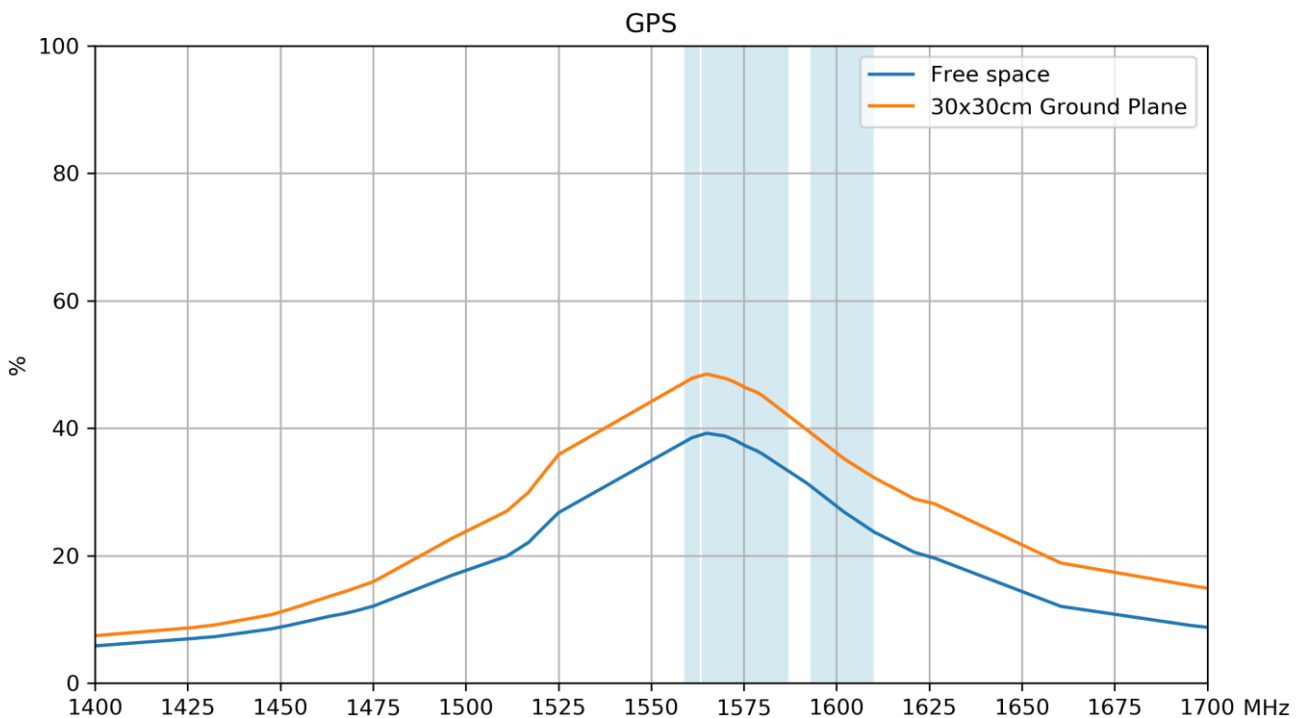

### 3.3 Average Gain

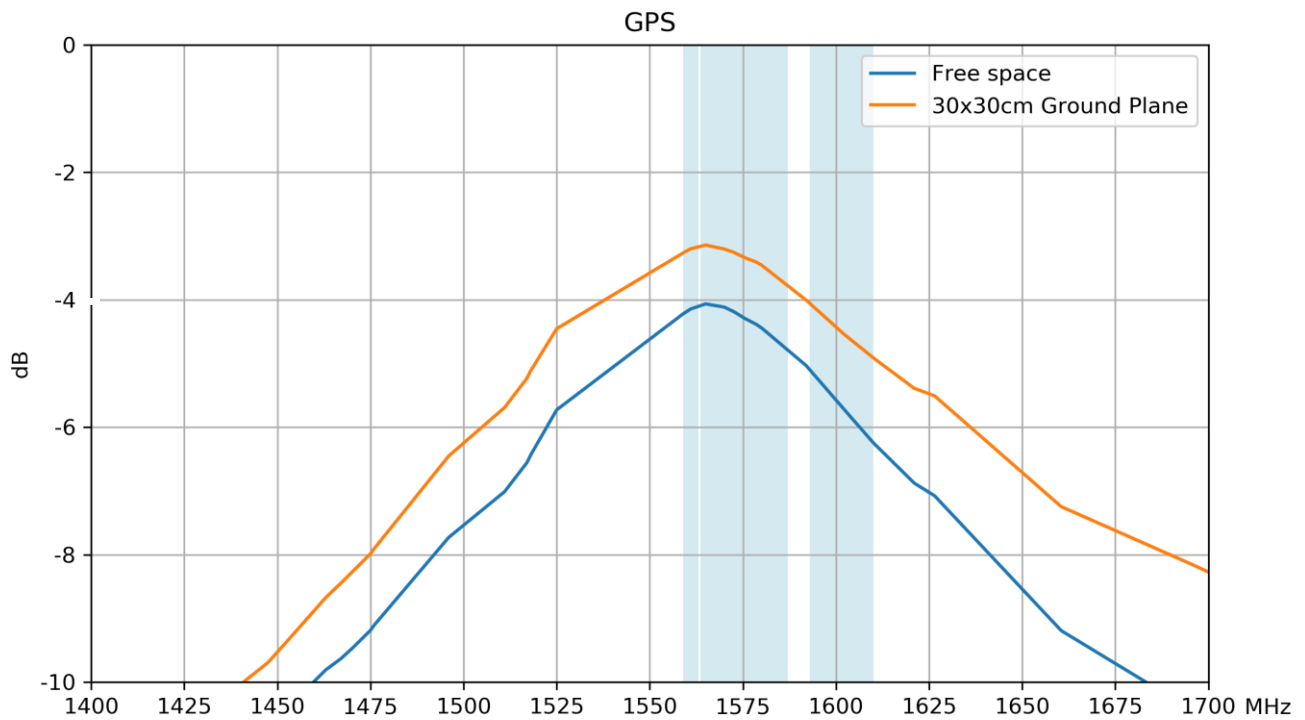

### 3.4 Peak Gain

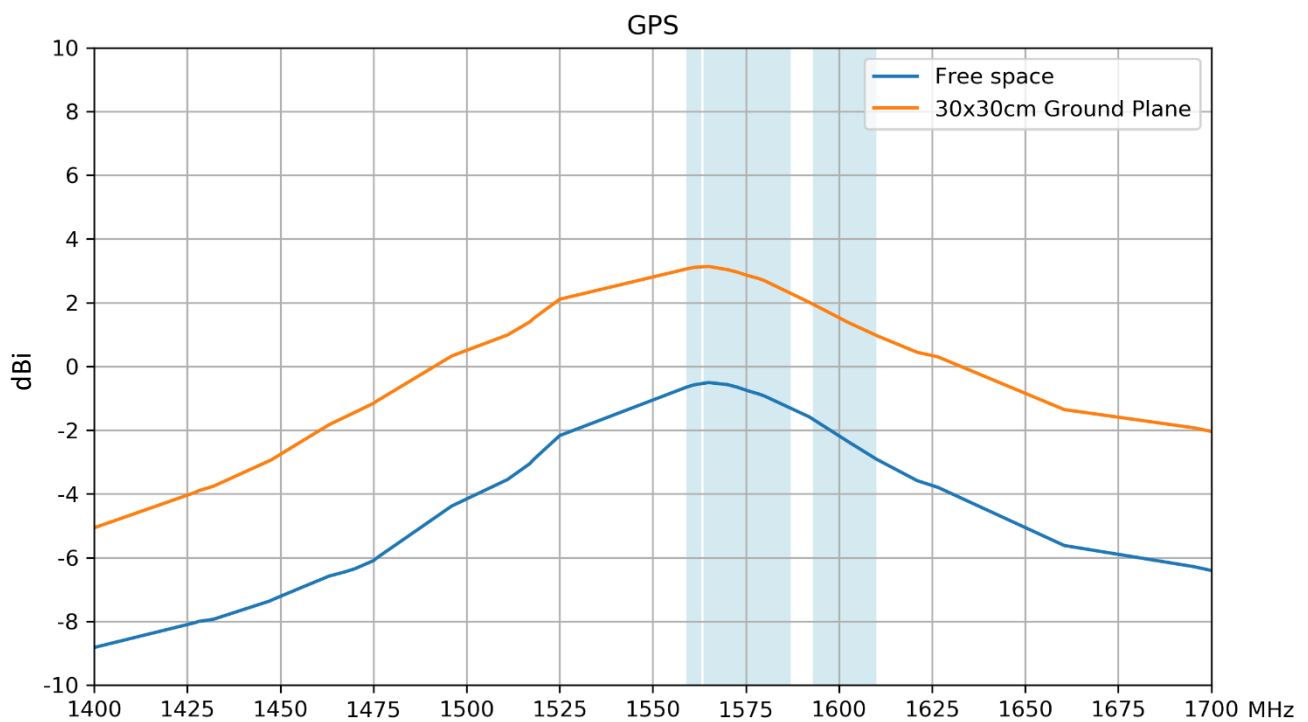



### 3.5 Axial Ratio @ 1561MHz

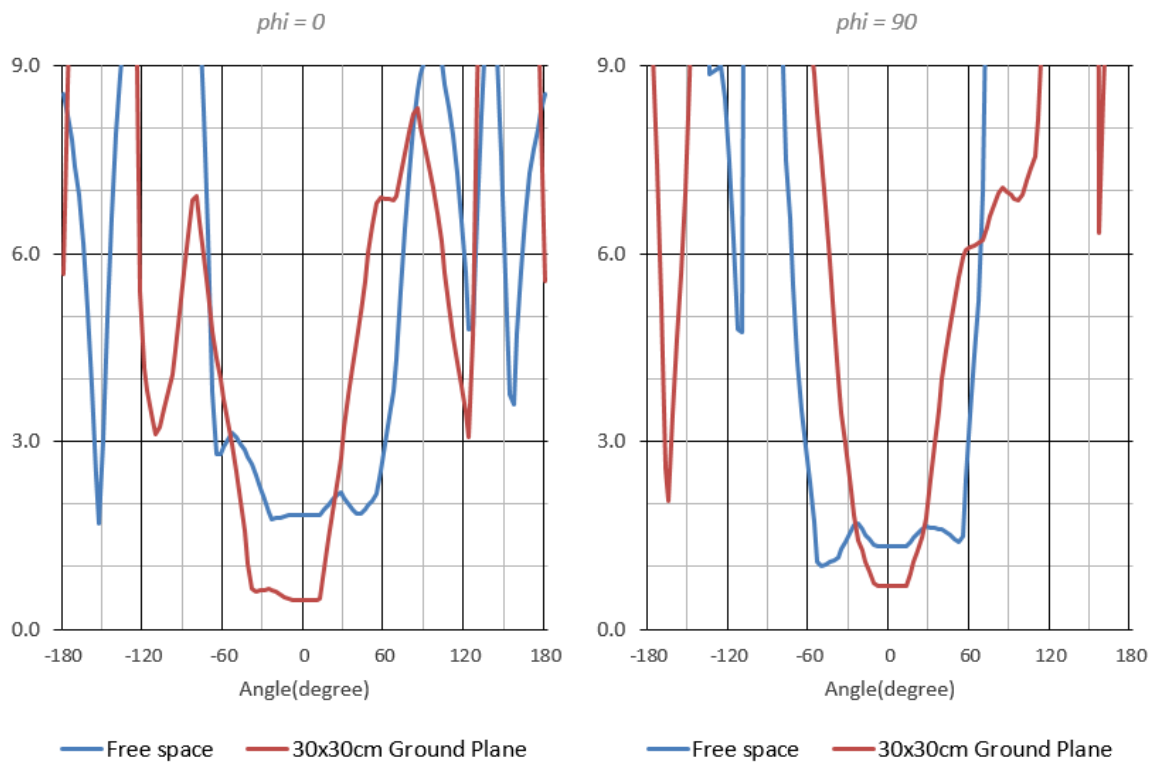

### 3.6 Axial Ratio @ 1575MHz

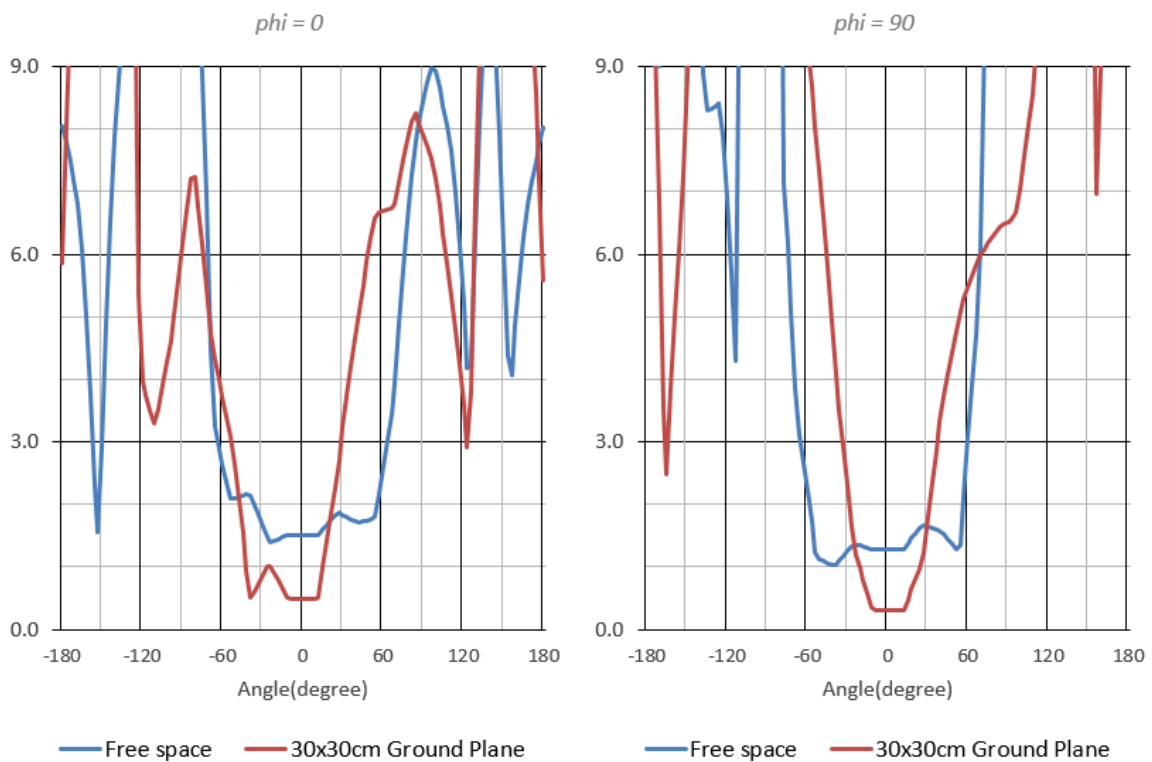

### 3.7 Axial Ratio @ 1602MHz

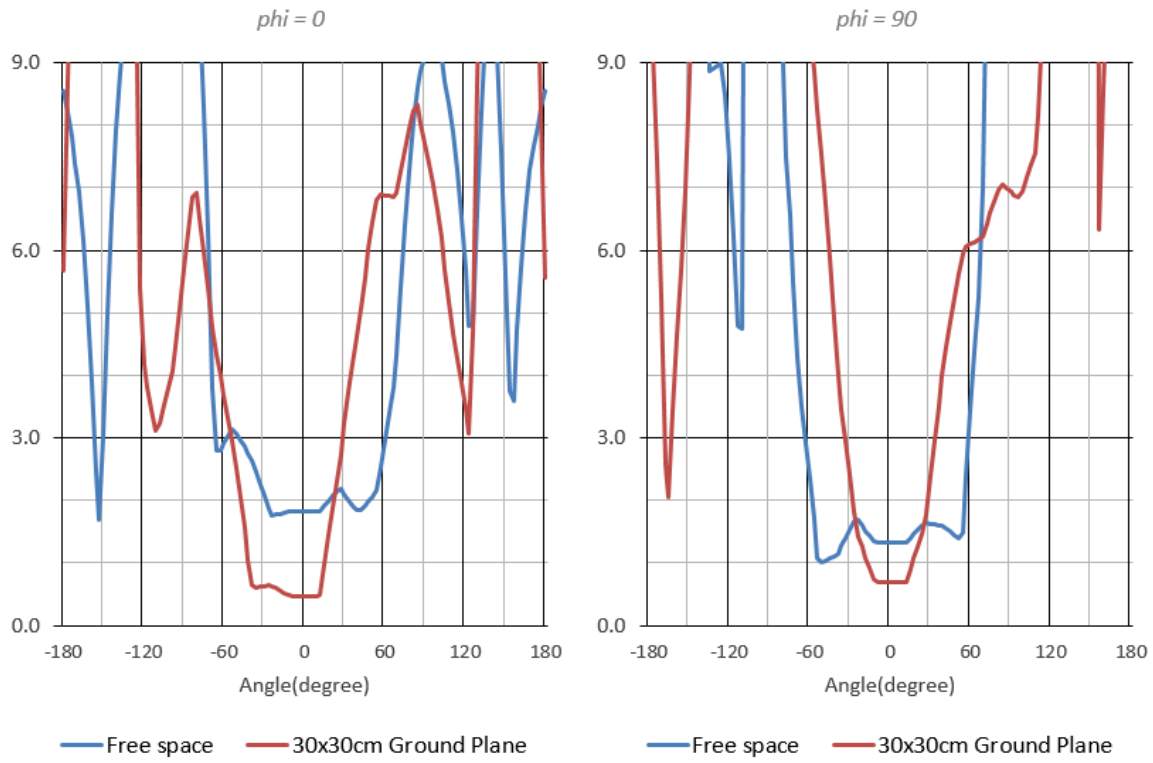

## 4. Radiation Patterns

### 4.1 Test Setup – Free Space

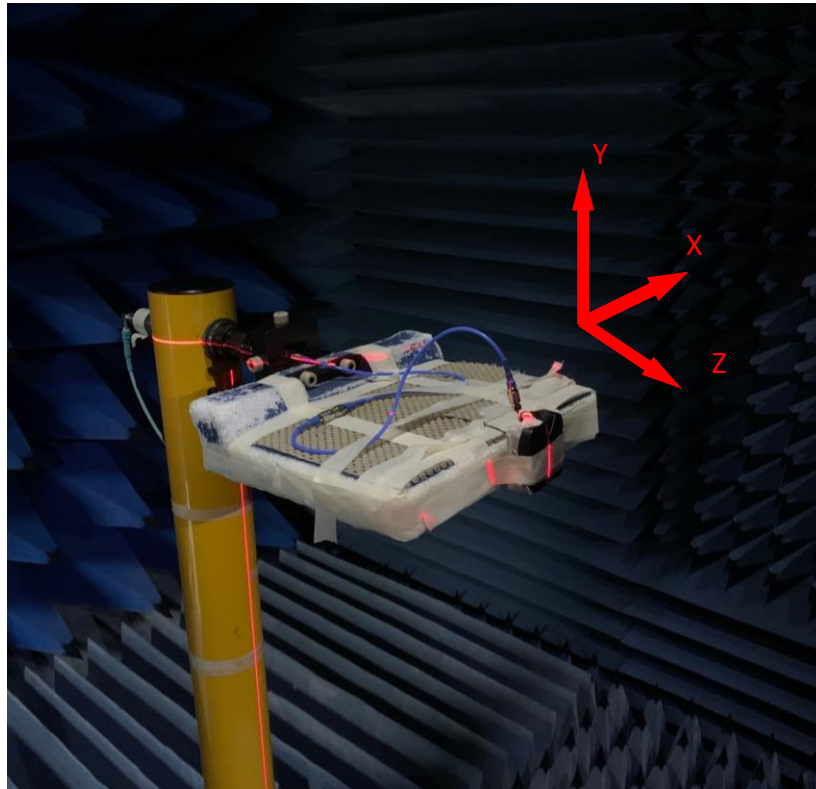

## 4.2 Test Setup – on 30\*30cm Ground Plane

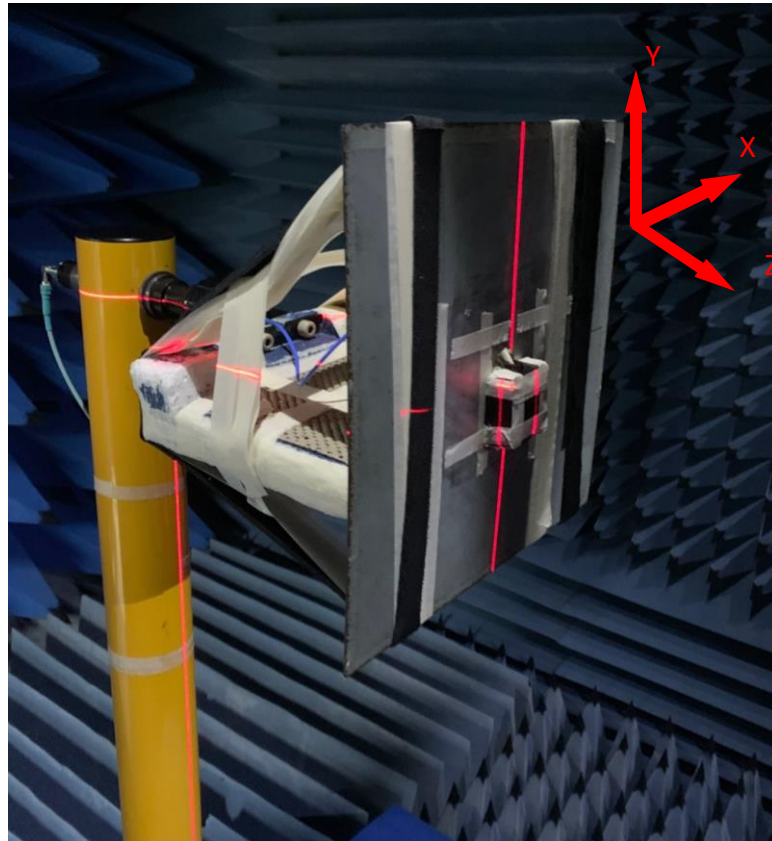

4.3 1561MHz 3D and 2D Radiation Patterns – Free Space

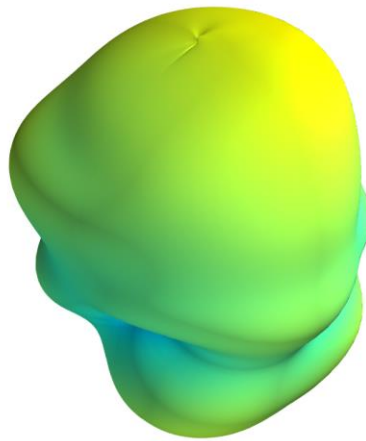

XY Plane

XZ Plane

YZ Plane

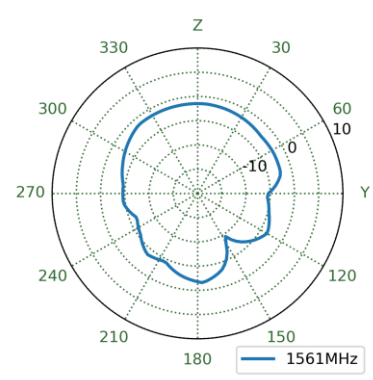
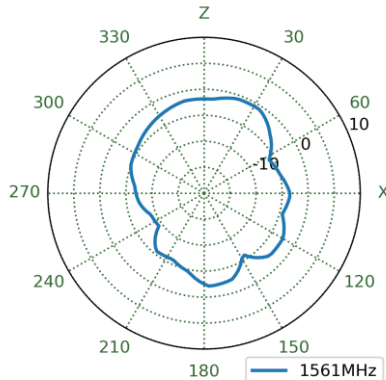
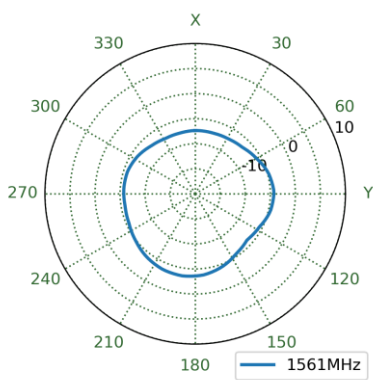

4.4 1575.42MHz 3D and 2D Radiation Patterns – Free Space

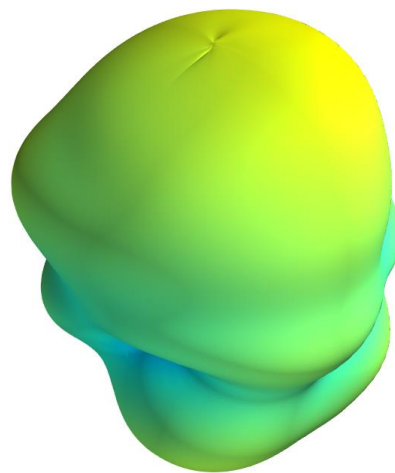

XY Plane

XZ Plane

YZ Plane

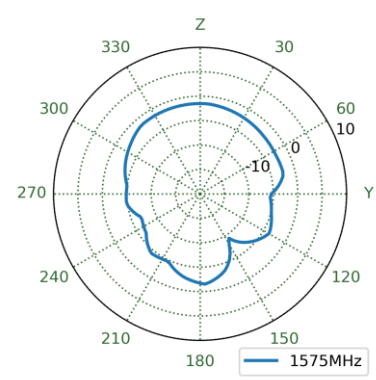
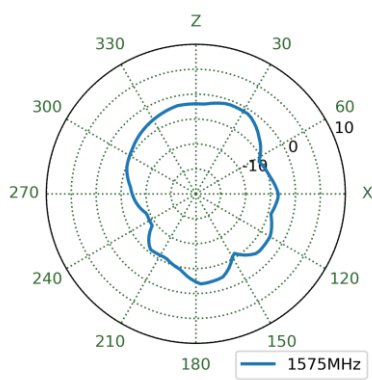
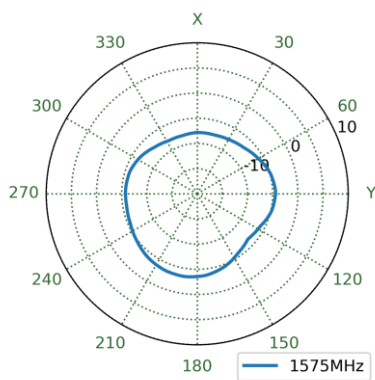

4.5 1602MHz 3D and 2D Radiation Patterns – Free Space

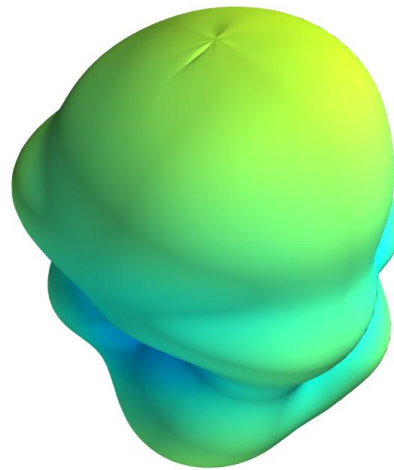

XY Plane                      XZ Plane                      YZ Plane

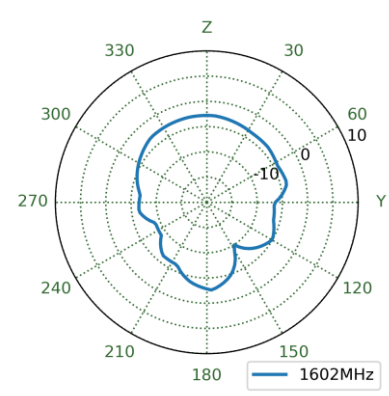
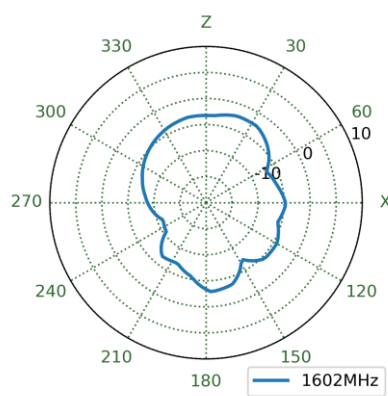
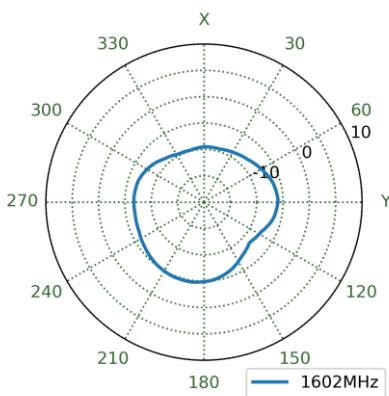

4.6 1561MHz 3D and 2D Radiation Patterns – On 30\*30cm Ground Plane

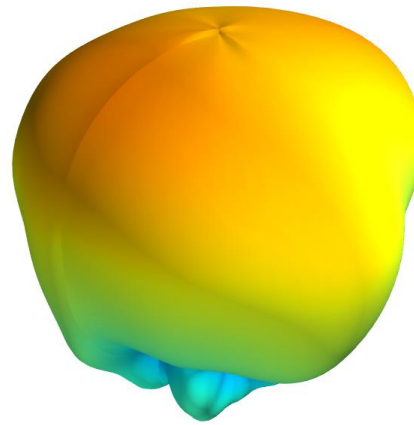

XY Plane

XZ Plane

YZ Plane

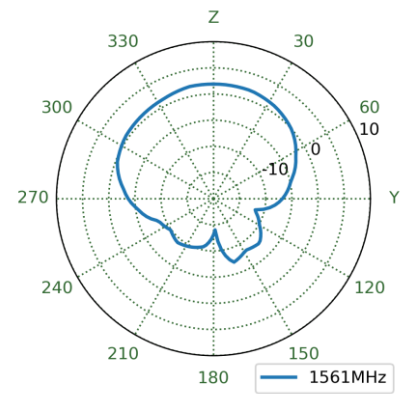
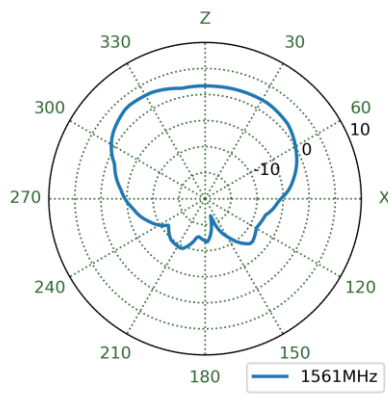
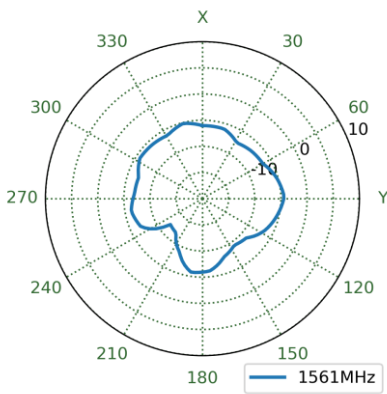



4.7 1575.42MHz 3D and 2D Radiation Patterns – On 30\*30cm Ground Plane

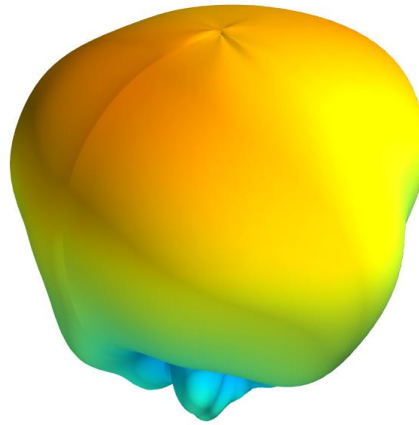

XY Plane

XZ Plane

YZ Plane

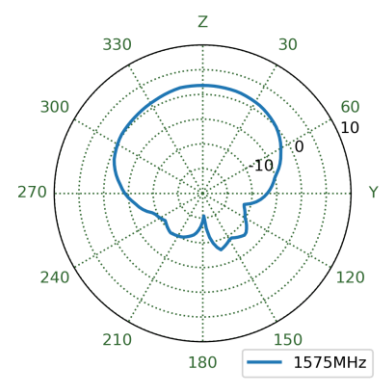
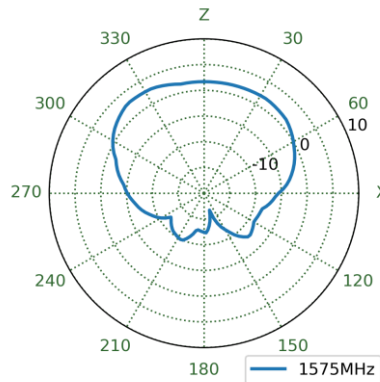
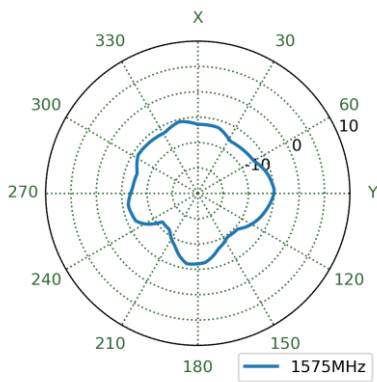

4.8 1602 MHz 3D and 2D Radiation Patterns – On 30\*30cm Ground Plane

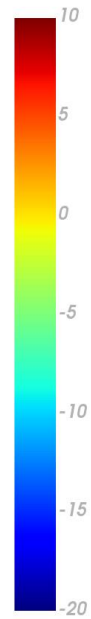
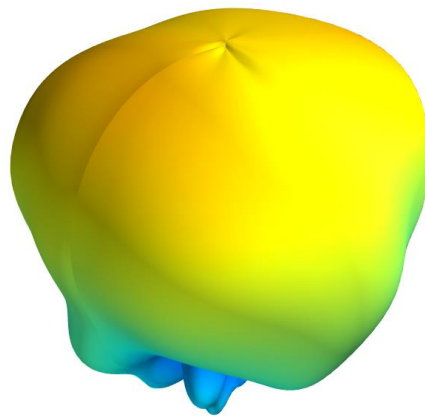

XY Plane

XZ Plane

YZ Plane

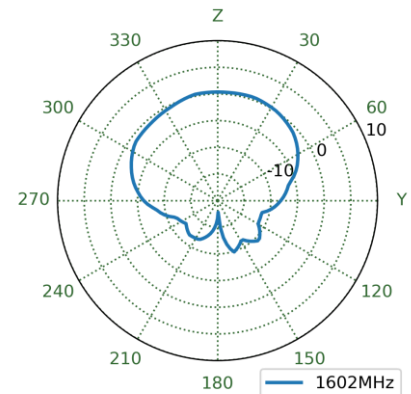
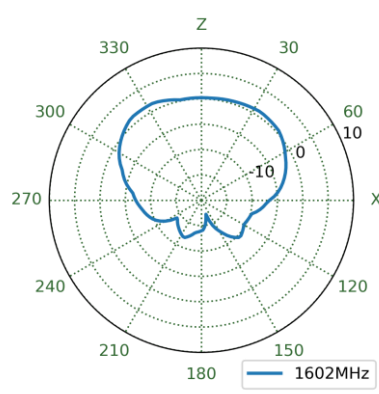
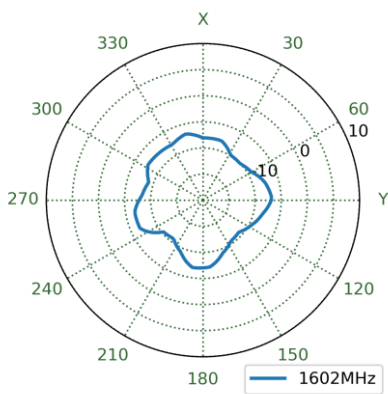

## 5. Active Characteristics

### 5.1 Block Diagram

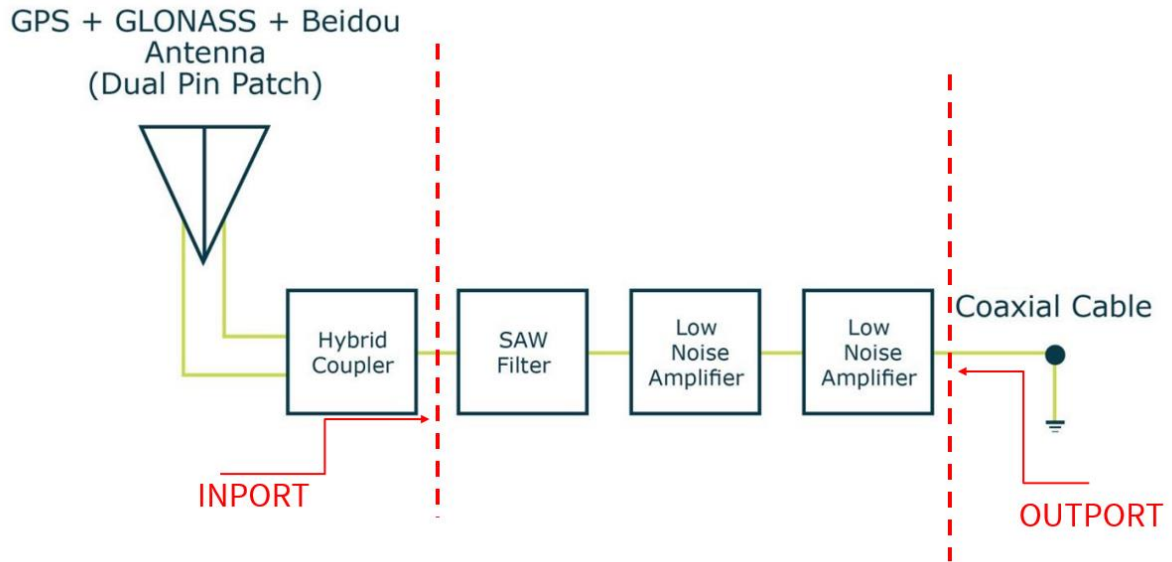

### 5.2 LNA Gain @ 3V

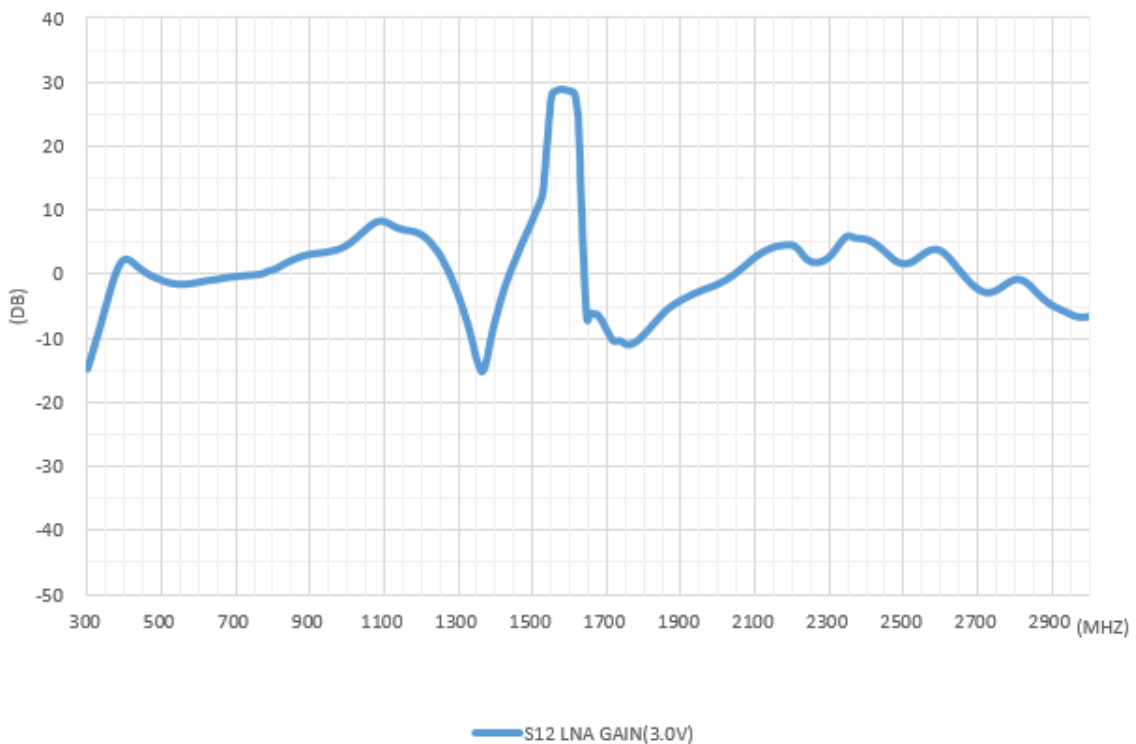

### 5.3 Block Diagram

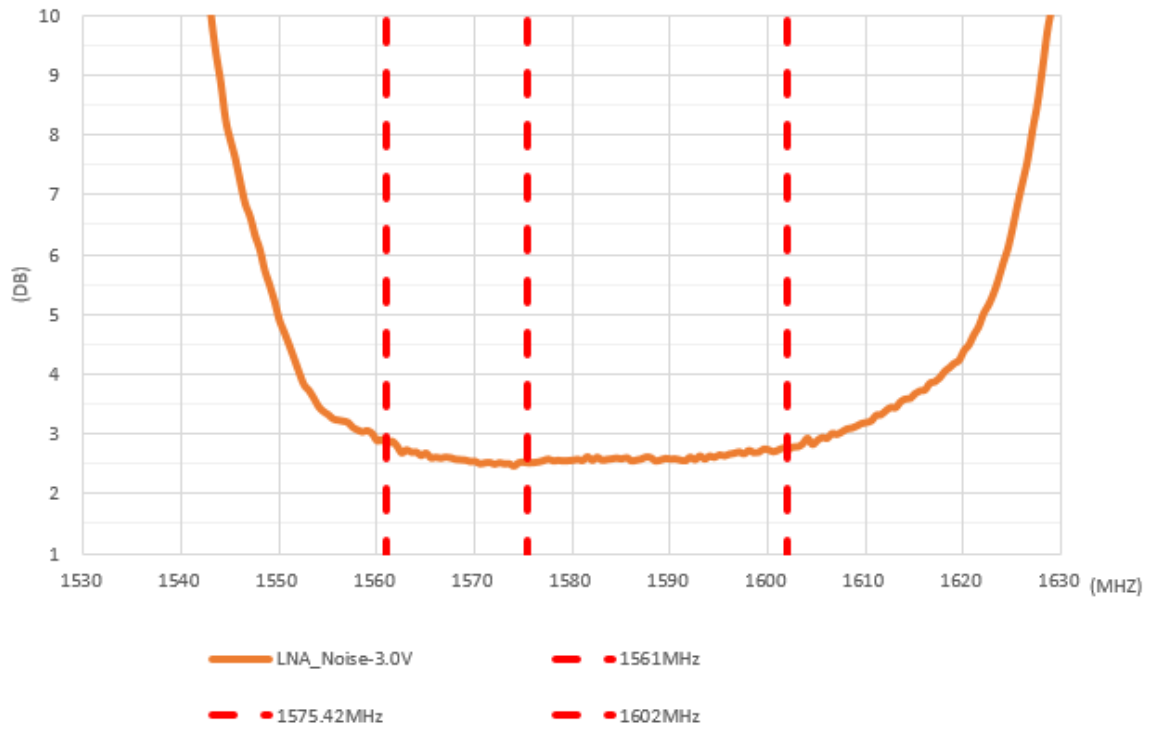

## 6. Field Test Results

### 6.1 Rooftop test

In this section Taoglas will present the field test result for AA.171 antenna. The test was performed when the antenna was mounted on a static rooftop test set up in an open sky environment for at least **6 hours**.

Taoglas will show the field test results using the following receiver:

#### 1. U-blox ZED-F9P

##### Receiver features:

- Multi-band GNSS: 184-channel GPS L1C/A L2C, GLONASS: L1OF L2OF, Galileo: E1B/C E5b, BeiDou: B1I B2I, QZSS: L1C/A L2C
- Multi-band RTK with fast convergence times and reliable performance
- Nav. update rate RTK up to 20 Hz
- Position accuracy = RTK 0.01 m + 1 ppm CEP

Positioning Accuracy Table (2D Accuracy)					
Test Condition	Correction Service	CEP (50%)	DRMS (68%)	2DRMS (95-98.2%)	TTF (sec)
30x30 cm Ground Plane	RTK DISABLED	77.22 cm	93.73 cm	187.47 cm	22
	RTK ENABLED	1.26 cm	1.52 cm	3.04 cm	22

RTK Availability  
30x30 cm Ground Plane

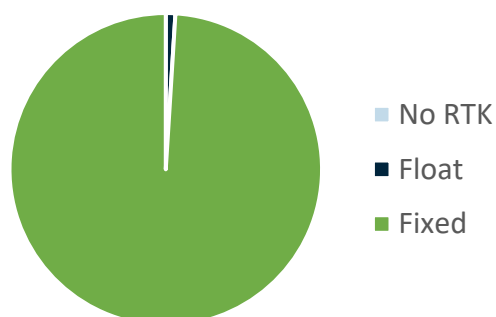

## 7. Pull Force Test (Units: mm)

### 7.1 Test Setup

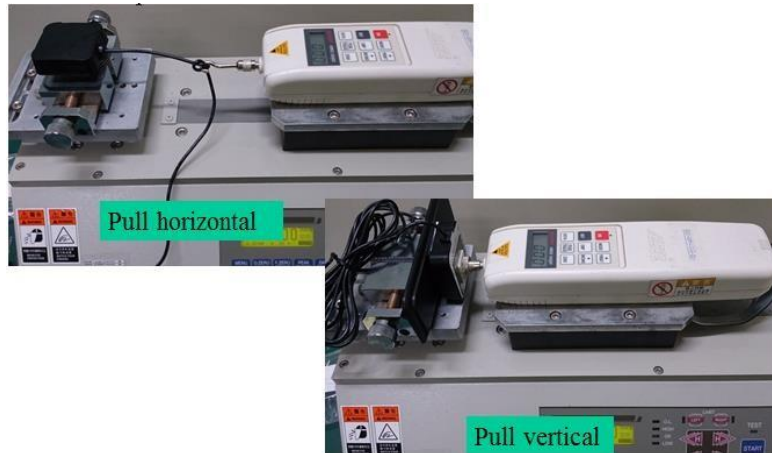

## 7.2 Horizontal Pull Force Breakdown

Horizontal Pull Force Breakdown: 0.52kgf

Distance(mm)	0.5	1.0	2.0	3.0	4.0	5.0	6.0	7.0	8.0	9.0
Pulling force(Kgf)	0	0	0.18	0.31	0.3	0.3	0.3	0.3	0.3	0.3
Distance(mm)	10.0	11.0	12.0	13.0	14.0	15.0	16.0	16.3	17.0	18.0
Pulling force(Kgf)	0.3	0.27	0.24	0.29	0.3	0.44	0.52	0.54	0.42	0.37

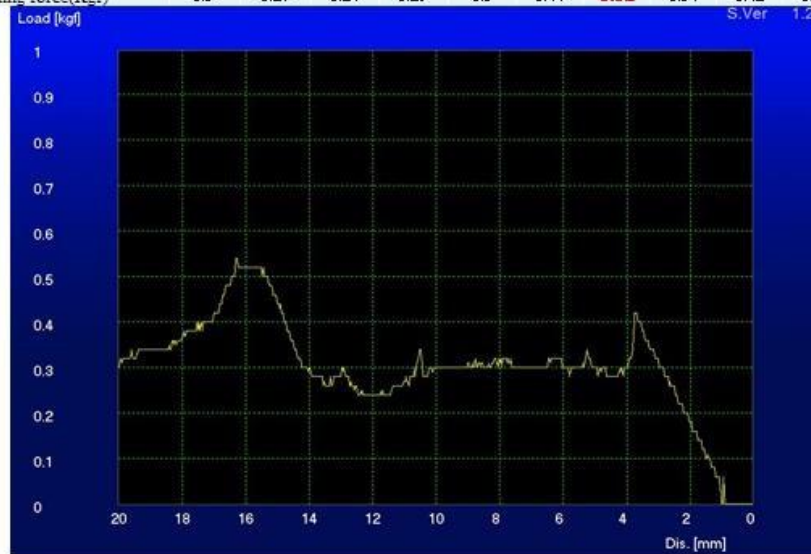

## 7.3 Vertical Pull Force Breakdown

Vertical Pull Force Breakdown: 1.23 kgf

Distance(mm)	0.5	1.0	1.5	2.0	2.5	3.0	3.5	4.0	4.5	5.0
Pulling force (Kgf)	0.96	1.07	1.23	0.84	0.55	0.42	0.38	0.35	0.34	0.32

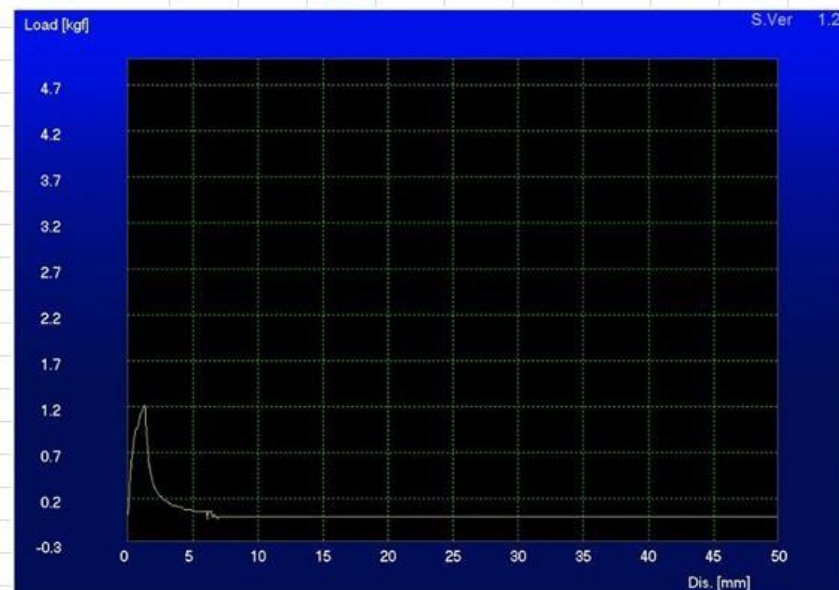

# 8. Mechanical Drawing (Units: mm)

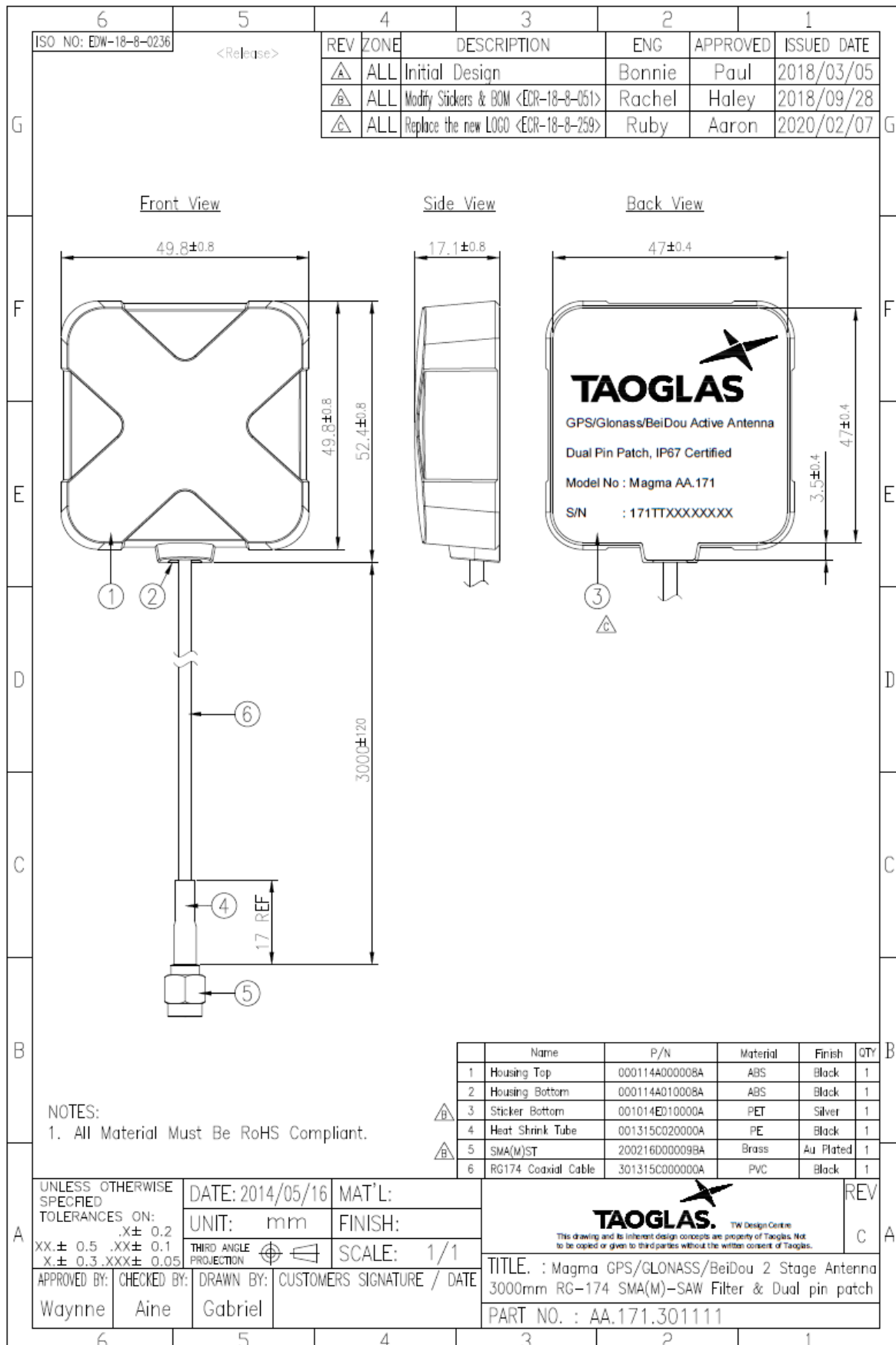



## 9. Packaging

1 pc AA.171.301111 in PE Bag  
 Dimensions - 230\*100mm  
 Weight - 91g

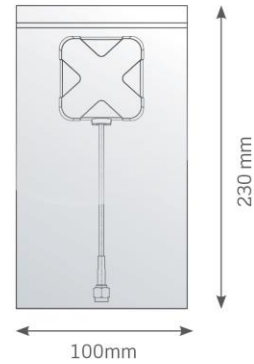

10pc AA.171.301111 in large PE Bag  
 Dimensions - 200\*450mm  
 Weight - 9.34Kg

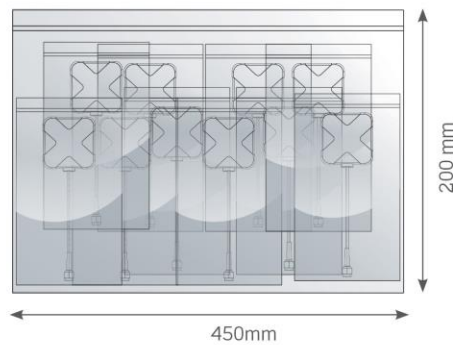

100 pcs  
 10 Large PE Bags in one carton  
 Carton Dimensions - 370\*370\*300mm  
 Weight - 10.3Kg

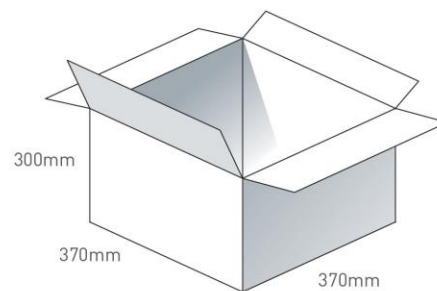

Pallet Dimensions 1200\*1000\*1400mm  
 24 Cartons per Pallet  
 6 Cartons per layer  
 4 Layers

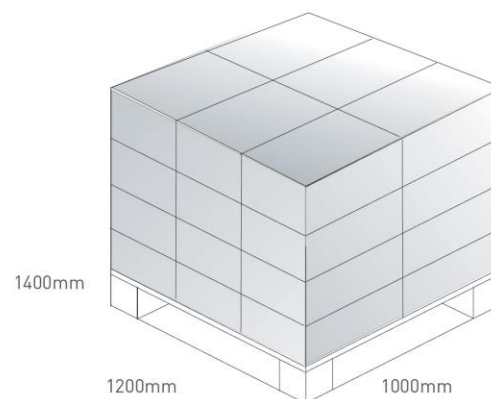

Changelog for the datasheet

**SPE-15-8-002 – AA.171.301111**

**Revision: G (Current Version)**

Date:	2022-02-22
Changes:	Updated GNSS Bands & Constellations Graphics
Changes Made by:	Cesar Sousa

**Previous Revisions**

**Revision: F**

Date:	2020-05-02
Changes:	Field Test results Added
Changes Made by:	Victor Pinazo

**Revision: A (Original First Release)**

Date:	2015-01-14
Notes:	Initial Datasheet Release
Author:	Aine Doyle

**Revision: E**

Date:	2020-02-25
Changes:	New Template and RTK Data
Changes Made by:	Jack Conroy

**Revision: D**

Date:	2018-11-09
Changes:	New Drawing
Changes Made by:	Sean Hancox

**Revision: C**

Date:	2018-04-04
Changes:	New Packaging
Changes Made by:	Carol Faughnan

**Revision: B**

Date:	2020-05-02
Changes:	
Changes Made by:	Aine Doyle



**TAOGLAS**®

[www.taoglas.com](http://www.taoglas.com)