



TAOGLAS®



Datasheet

Monsoon

Part No:
GA.170.305111

Description:

5G/4G Monsoon Permanent Mount External Antenna
with 3000mm TGC-200 and SMA(M)

Features:

1*5G/4G Antenna
Worldwide 5G/4G Bands, 600MHz-6GHz
IP69K Rated, Robust ABS+PC Enclosure
Permanent (Screw) Mount Antenna
Cable: 3M TGC-200
Connector: SMA(M)ST
Dimensions: 204*69*31 mm
RoHS & Reach Compliant

1. Introduction	3
2. Specifications	4
3. Antenna Characteristics	7
4. Radiation Patterns	10
5. Mechanical Drawing	32
6. Packaging	33
<hr/>	
7. Application Note	34
<hr/>	
Changelog	37

Taoglas makes no warranties based on the accuracy or completeness of the contents of this document and reserves the right to make changes to specifications and product descriptions at any time without notice. Taoglas reserves all rights to this document and the information contained herein. Reproduction, use or disclosure to third parties without express permission is strictly prohibited.



1. Introduction



The Taoglas GA.170 Monsoon antenna is a low profile, fully IP69K waterproof external M2M antenna for use on containers for global telematics services. The GA.170 delivers best-in-class 5G/4G antenna performance from 600-6000MHz.

Typical applications include:

- HD Video over LTE
- First Responder and Emergency Services
- Intelligent Transport Systems
- Internet of Things (IoT market)
- High Definition Video Broadcast Systems
- Wireless LTE M2M Devices
- Digital Signage

5G/4G applications demand high speed data uplink and downlink. A high-efficiency and high-gain antenna is required to achieve the required signal to noise ratio and throughput required to solve these challenges. The GA.170 does not require a ground plane. Low loss cables are used to keep efficiency high over long cable lengths.

Cables and connectors are fully customizable. Contact your regional Taoglas customer support team for further information.

2. Specifications

Cellular											
Frequency (MHz)	5G NR Band	LTE700	GSM 850/900	5G NR Band	DCS	PCS	UMTS1	LTE2600	5G NR Band 77, 78, 79	LTE5200/ Wi-Fi 5800	
	617 ~698	698 ~806	824 ~960	1427~ 1518	1710 ~1880	1850 ~1990	1920 ~2170	2490 ~2690	3300 ~3500	5150 ~5925	
Efficiency (%)											
Free space	0.3m	33.54	55.25	57.26	25.92	54.79	54.93	52.11	52.30	58.39	67.81
	1m	32.04	52.64	54.55	24.29	50.55	50.68	47.90	47.48	51.64	57.92
	2m	30.02	49.13	50.91	22.13	45.05	45.17	42.47	41.36	43.34	46.26
	3m	28.13	45.85	47.51	20.16	40.15	40.25	37.66	36.02	36.38	36.94
	5m	24.70	39.93	41.38	16.73	31.90	31.98	29.62	27.32	25.64	23.57
30x30cm Ground Plane	0.3m	42.25	57.68	66.18	16.82	60.43	61.07	53.58	51.85	57.69	70.42
	1m	40.37	54.96	63.05	15.75	55.75	56.34	49.24	47.07	51.03	60.16
	2m	37.83	51.29	58.85	14.35	49.69	50.22	43.65	41.00	42.83	48.04
	3m	35.45	47.87	54.92	13.07	44.28	44.76	38.70	35.71	35.95	38.36
	5m	31.13	41.69	47.83	10.85	35.18	35.55	30.42	27.09	25.34	24.47
Average Gain											
Free space	0.3m	-4.74	-2.58	-2.42	-5.86	-2.61	-2.60	-2.83	-2.81	-2.34	-1.69
	1m	-4.94	-2.79	-2.63	-6.15	-2.96	-2.95	-3.20	-3.23	-2.87	-2.37
	2m	-5.23	-3.09	-2.93	-6.55	-3.46	-3.45	-3.72	-3.83	-3.63	-3.35
	3m	-5.51	-3.39	-3.23	-6.96	-3.96	-3.95	-4.24	-4.43	-4.39	-4.32
	5m	-6.07	-3.99	-3.83	-7.76	-4.96	-4.95	-5.28	-5.63	-5.91	-6.28
30x30cm Ground Plane	0.3m	-3.74	-2.39	-1.79	-7.74	-2.19	-2.14	-2.71	-2.85	-2.39	-1.52
	1m	-3.94	-2.60	-2.00	-8.03	-2.54	-2.49	-3.08	-3.27	-2.92	-2.21
	2m	-4.22	-2.90	-2.30	-8.43	-3.04	-2.99	-3.60	-3.87	-3.68	-3.18
	3m	-4.50	-3.20	-2.60	-8.84	-3.54	-3.49	-4.12	-4.47	-4.44	-4.16
	5m	-5.07	-3.80	-3.20	-9.65	-4.54	-4.49	-5.17	-5.67	-5.96	-6.11
Peak Gain											
Free space	0.3m	-0.20	1.74	1.69	-2.28	3.17	6.24	5.29	5.97	7.01	6.32
	1m	-0.40	1.53	1.48	-2.56	2.82	5.89	4.93	5.55	6.48	5.64
	2m	-0.68	1.23	1.18	-2.97	2.32	5.39	4.41	4.95	5.72	4.66
	3m	-0.96	0.93	0.88	-3.37	1.82	4.89	3.89	4.35	4.96	3.69
	5m	-1.52	0.33	0.28	-4.18	0.82	3.89	2.86	3.15	3.44	1.73
30x30cm Ground Plane	0.3m	1.72	1.86	2.94	-1.77	6.22	5.50	5.34	7.03	6.55	7.12
	1.0m	1.52	1.65	2.73	-2.06	5.87	5.15	4.98	6.61	6.01	6.43
	2.0m	1.25	1.35	2.43	-2.46	5.37	4.65	4.46	6.01	5.25	5.46
	3.0m	0.97	1.05	2.13	-2.87	4.87	4.15	3.94	5.41	4.49	4.48
	5.0m	0.41	0.45	1.53	-3.68	3.87	3.15	2.90	4.21	2.97	2.53
Impedance	50 Ω										
Polarization	Linear - Vertical										
Max Input Power	10W										

Mechanical	
Dimensions	204 x 69 x 31 mm
Cable	LTE : 3000mm TGC-200
Connector	LTE: SMA(M)
Casing	PC+ABS
Adhesive	3M 9448HK + CR4305
Sealant	Rubber Stopper
Weight	550 g
Recommended Mounting Torque	24.5N·m
Maximum Mounting Torque	29.5N·m
Environmental	
IP Rating	IP69K
Corrosion	5% NaCl for 96hrs - Nickel plated steel base and thread
Temperature Range	-40°C to +85°C
Thermal Shock	100 cycles -40°C to +85°C
Humidity	Non-condensing 65°C 95% RH
Shock (Drop Test)	1m drop on concrete 6 axes
Cable Pull	8 Kgf

5G/4G Bands			
Band Number	5G NR / FR1 / LTE / LTE-Advanced / WCDMA / HSPA / HSPA+ / TD-SCDMA		
	Uplink	Downlink	Covered
1	UL: 1920 to 1980	DL: 2110 to 2170	✓
2	UL: 1850 to 1910	DL: 1930 to 1990	✓
3	UL: 1710 to 1785	DL: 1805 to 1880	✓
4	UL: 1710 to 1755	DL: 2110 to 2155	✓
5	UL: 824 to 849	DL: 869 to 894	✓
7	UL: 2500 to 2570	DL: 2620 to 2690	✓
8	UL: 880 to 915	DL: 925 to 960	✓
9	UL: 1749.9 to 1784.9	DL: 1844.9 to 1879.9	✓
11	UL: 1427.9 to 1447.9	DL: 1475.9 to 1495.9	✓
12	UL: 699 to 716	DL: 729 to 746	✓
13	UL: 777 to 787	DL: 746 to 756	✓
14	UL: 788 to 798	DL: 758 to 768	✓
17	UL: 704 to 716	DL: 734 to 746 (LTE only)	✓
18	UL: 815 to 830	DL: 860 to 875 (LTE only)	✓
19	UL: 830 to 845	DL: 875 to 890	✓
20	UL: 832 to 862	DL: 791 to 821	✓
21	UL: 1447.9 to 1462.9	DL: 1495.9 to 1510.9	✗
22	UL: 3410 to 3490	DL: 3510 to 3590	✓
23	UL: 2000 to 2020	DL: 2180 to 2200 (LTE only)	✓
24	UL: 1625.5 to 1660.5	DL: 1525 to 1559 (LTE only)	✓
25	UL: 1850 to 1915	DL: 1930 to 1995	✓
26	UL: 814 to 849	DL: 859 to 894	✓
27	UL: 807 to 824	DL: 852 to 869 (LTE only)	✓
28	UL: 703 to 748	DL: 758 to 803 (LTE only)	✓
29	UL: -	DL: 717 to 728 (LTE only)	✓
30	UL: 2305 to 2315	DL: 2350 to 2360 (LTE only)	✓
31	UL: 452.5 to 457.5	DL: 462.5 to 467.5 (LTE only)	✗
32	UL: -	DL: 1452 - 1496	✓
35		1850 to 1910	✓
38		2570 to 2620	✓
39		1880 to 1920	✓
40		2300 to 2400	✓
41		2496 to 2690	✓
42		3400 to 3600	✓
43		3600 to 3800	✓
48		3550 to 3700	✓
66	UL: 1710-1780	DL: 2110-2200	✓
71		617 to 698	✓
74/75/76		1427 to 1518	✓
78		3300 to 3800	✓
79		4400 to 5000	✓

3. Antenna Characteristics

3.1 Return Loss

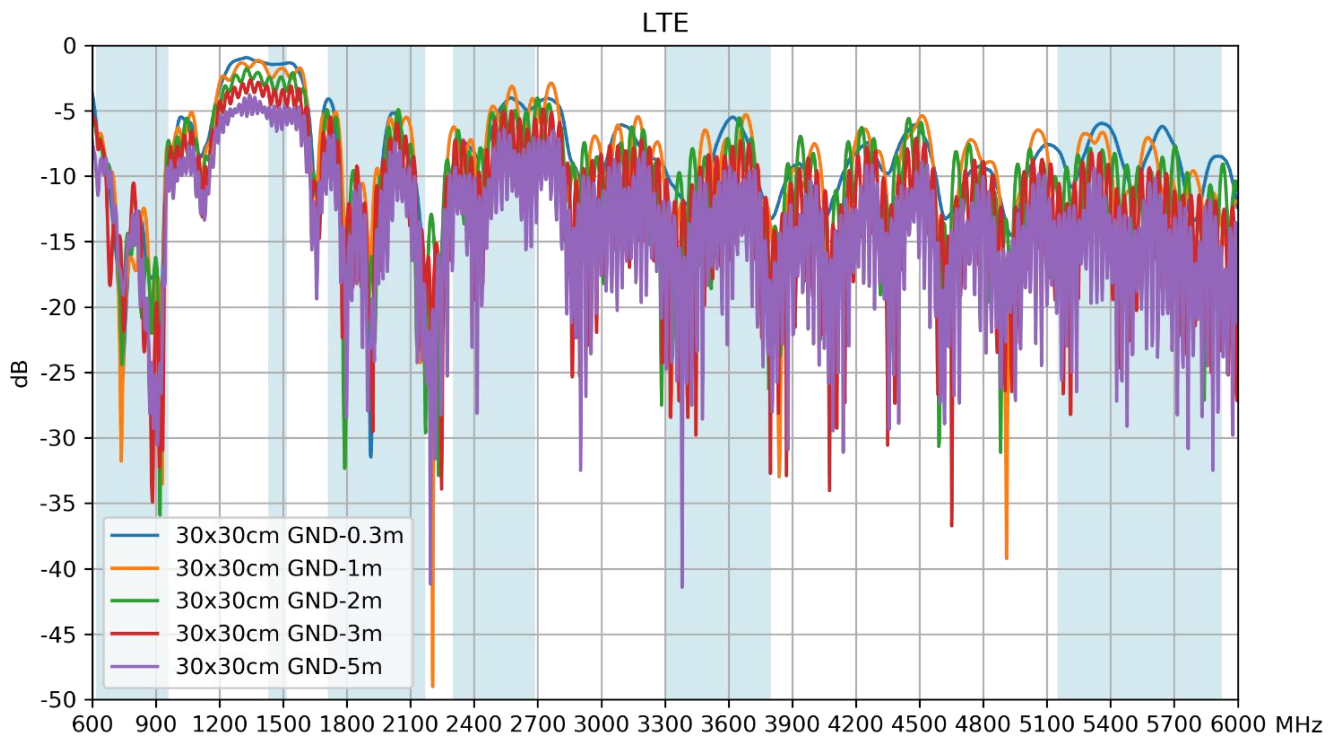
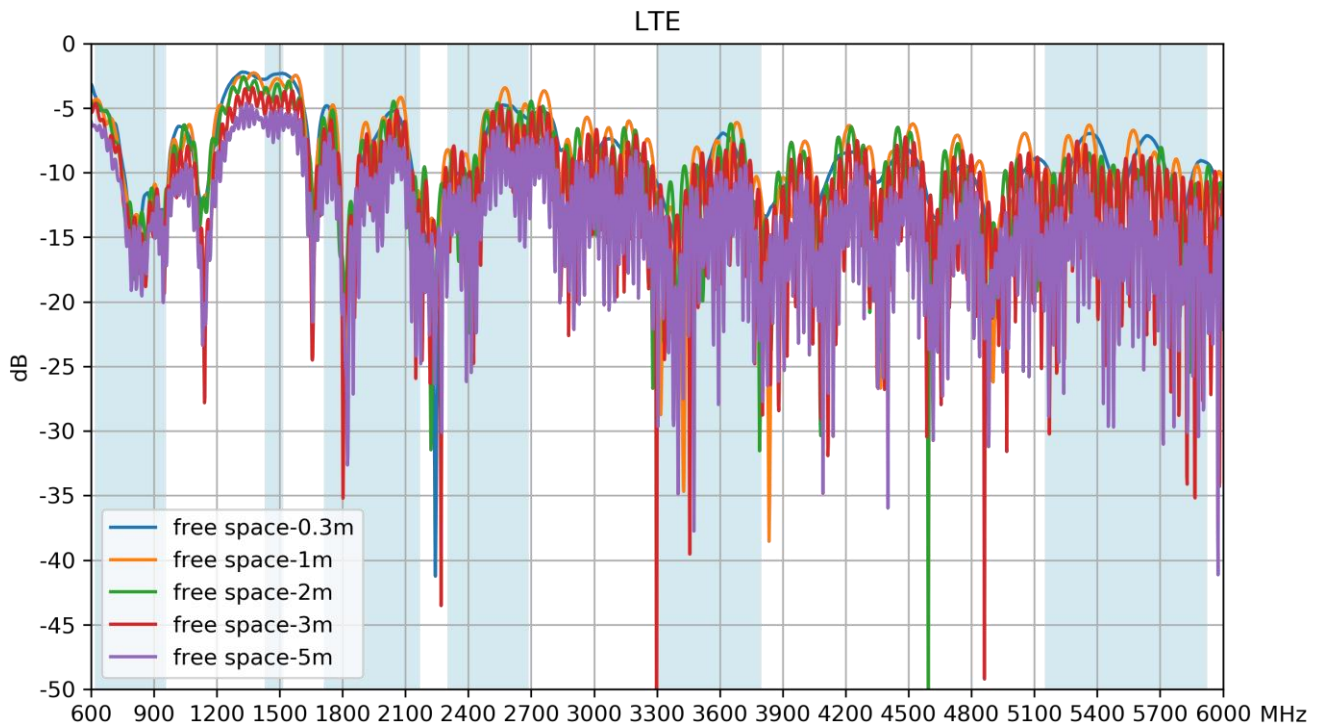

3.3 Efficiency

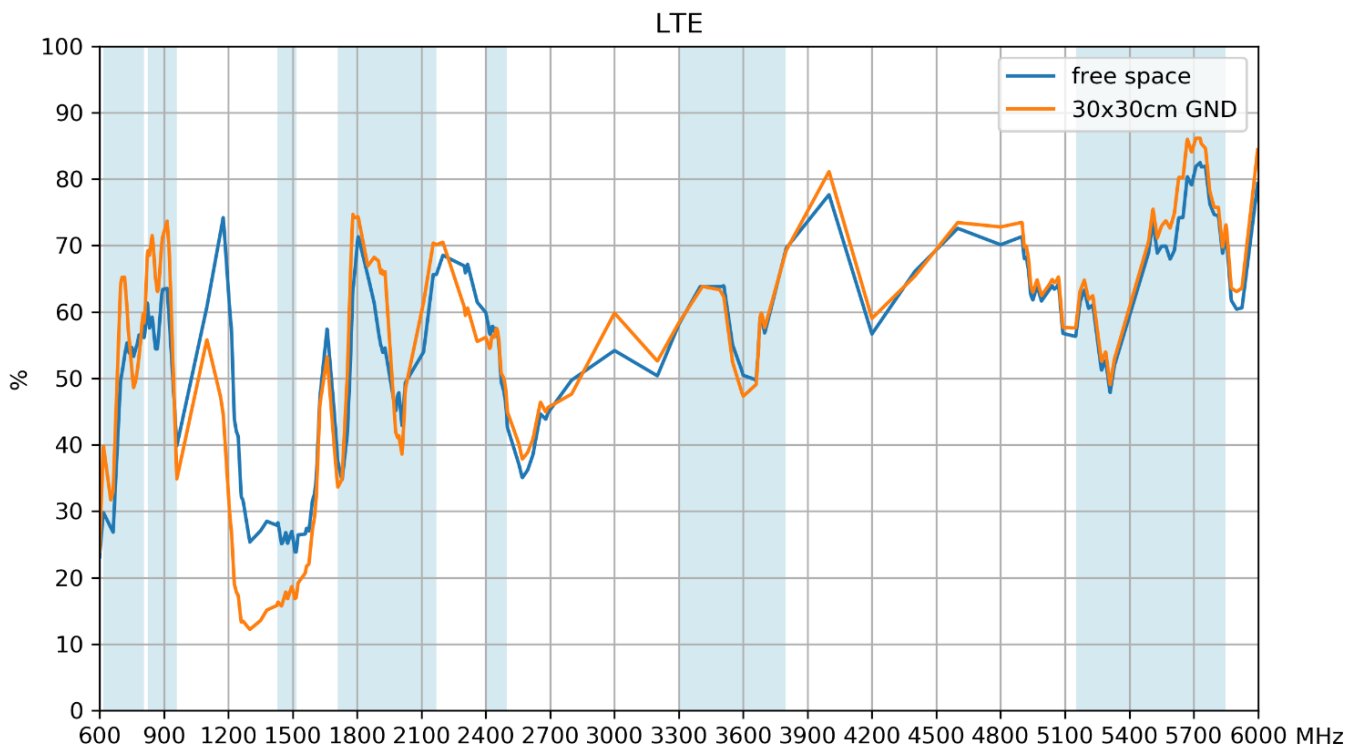

3.4 Average Gain

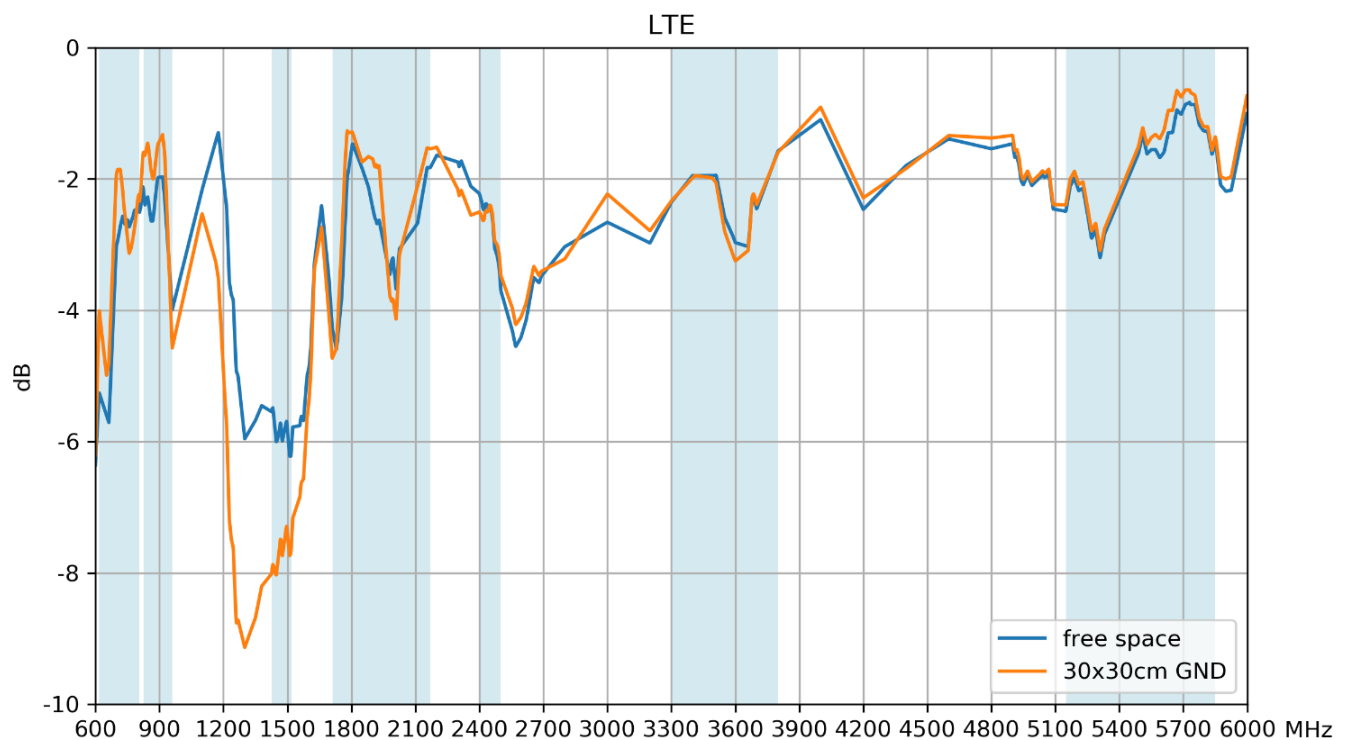

3.5 Peak Gain

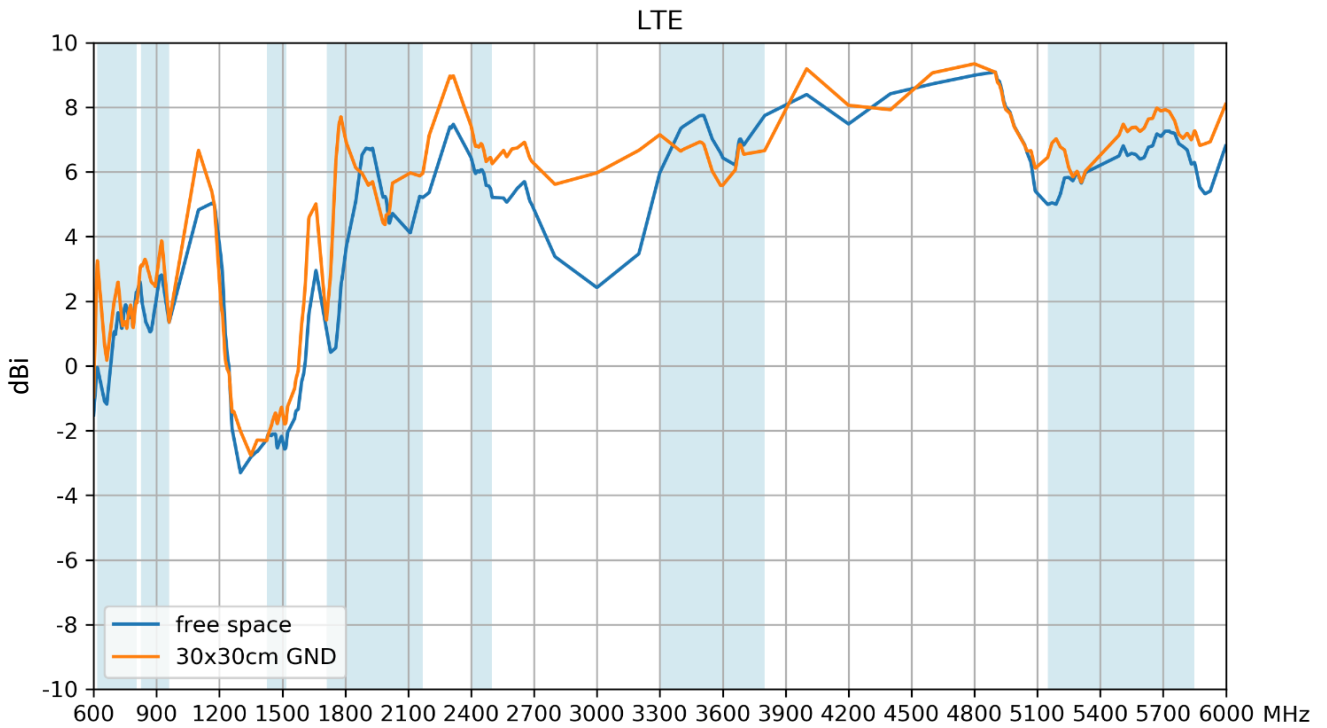

4. Radiation Patterns

4.1 Test Setup – Free Space



4.2 Cellular 3D and 2D Radiation Patterns

652MHz

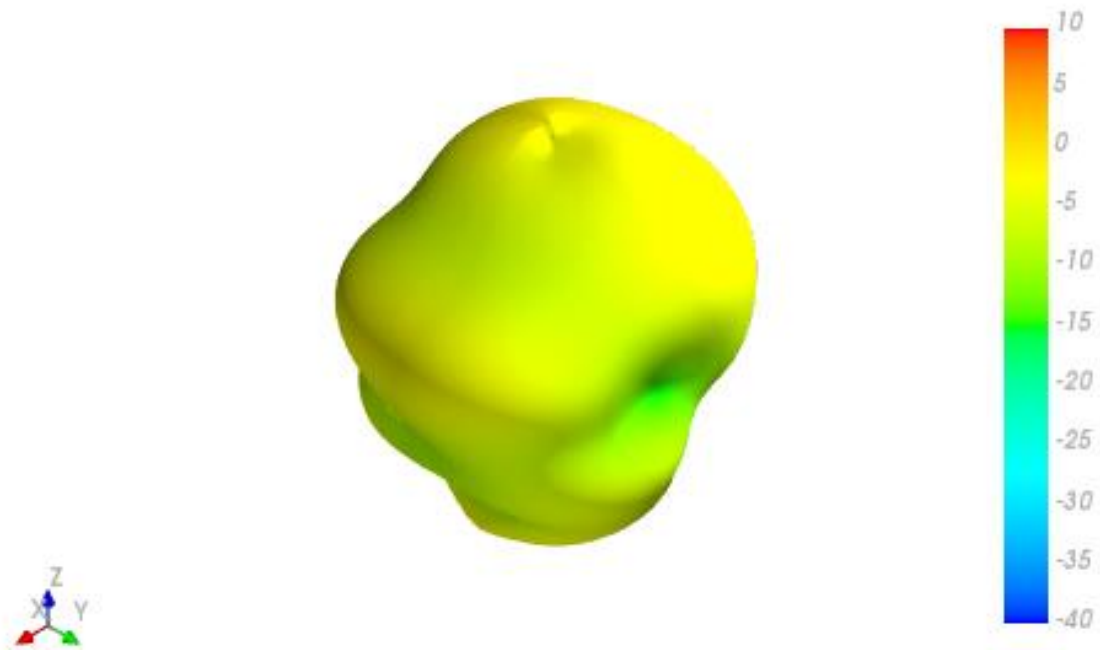

XY Plane

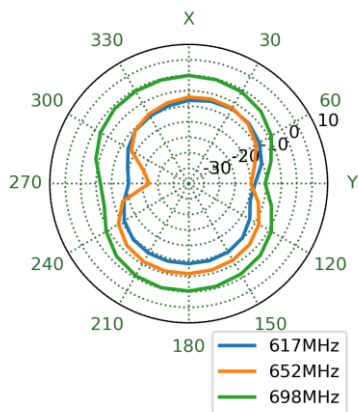

XZ Plane

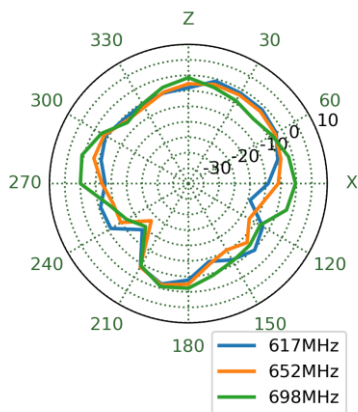

YZ Plane

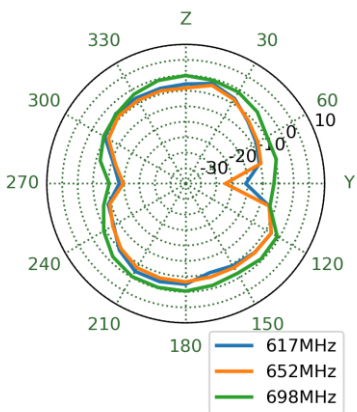

751MHz

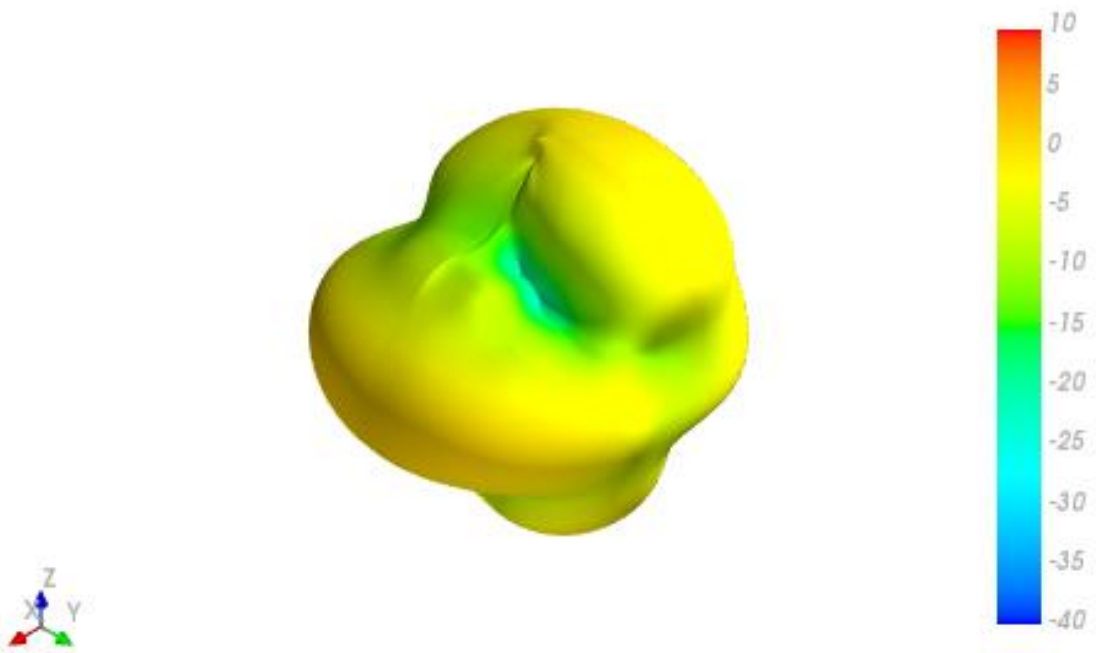

XY Plane

XZ Plane

YZ Plane

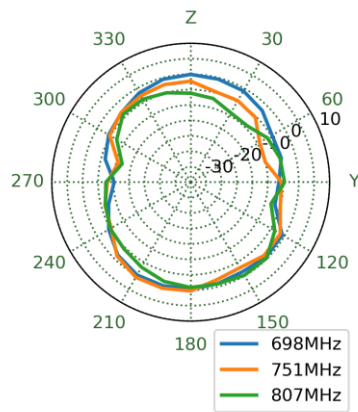
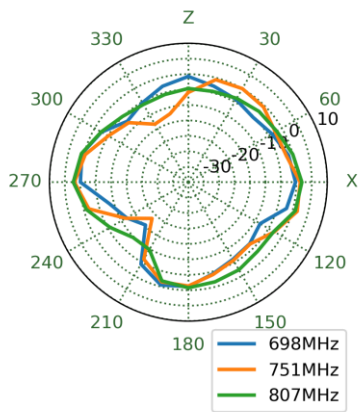
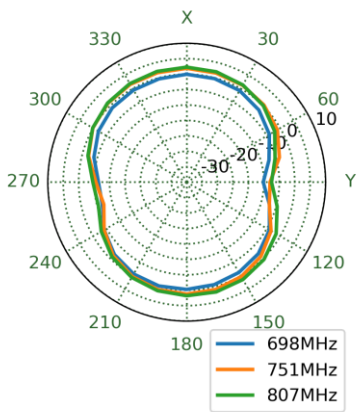

890MHz

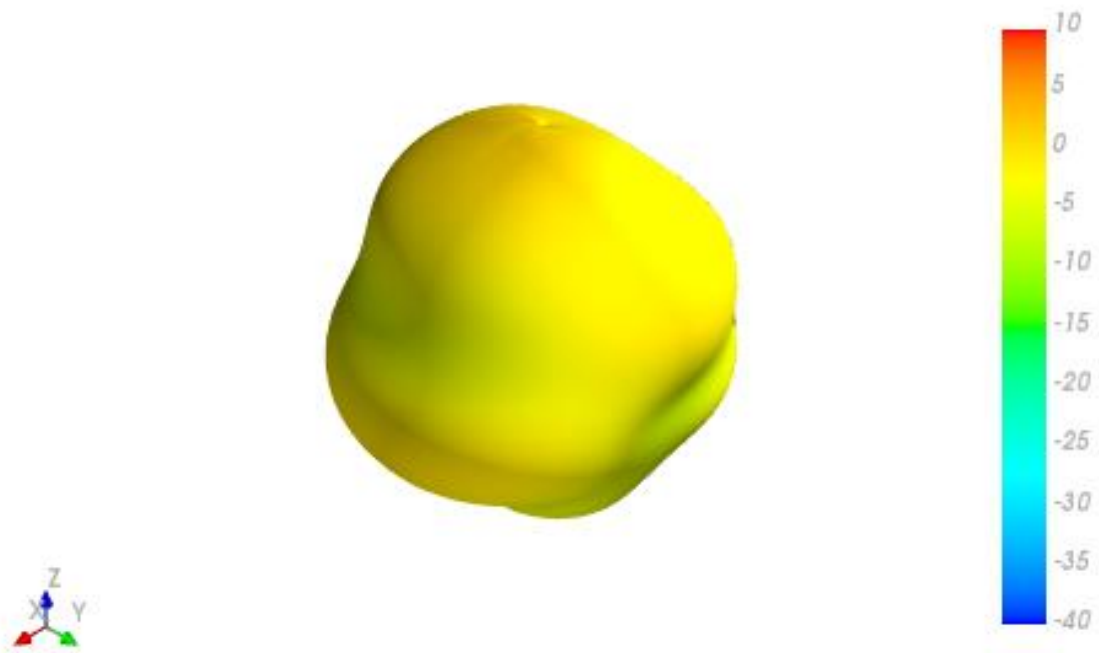

XY Plane

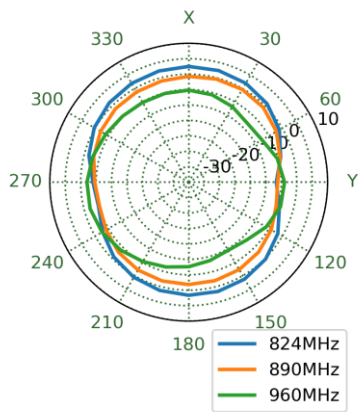

XZ Plane

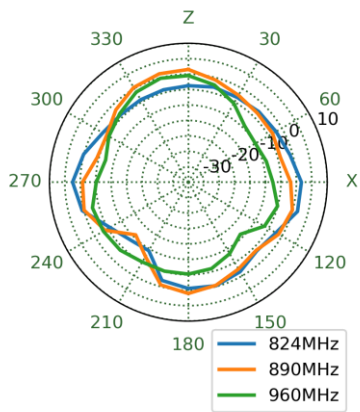

YZ Plane

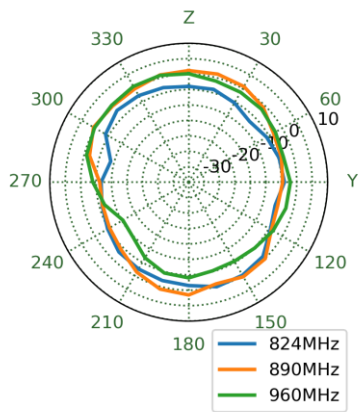

1470MHz



XY Plane

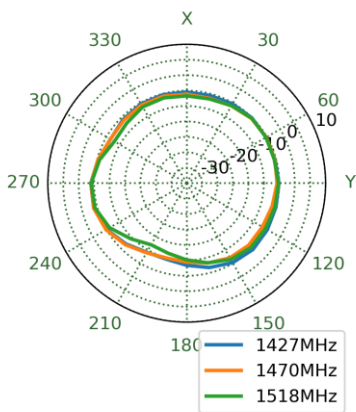

XZ Plane

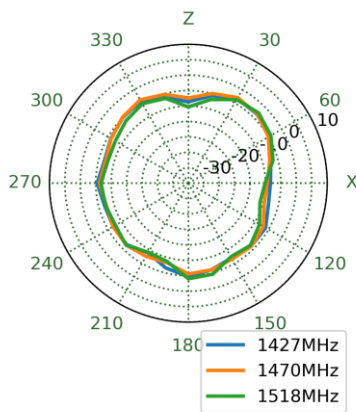

YZ Plane

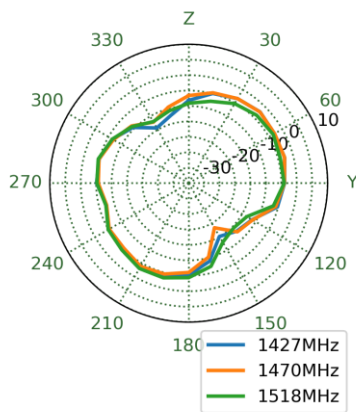

1805MHz

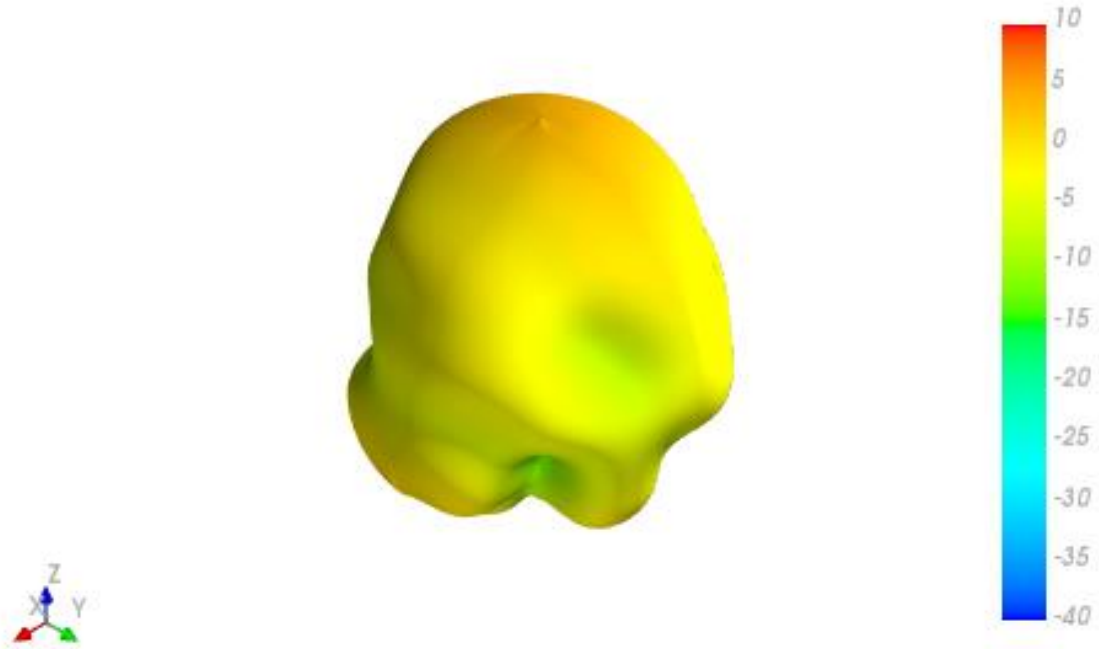

XY Plane

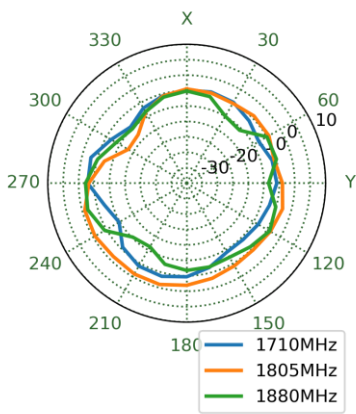

XZ Plane

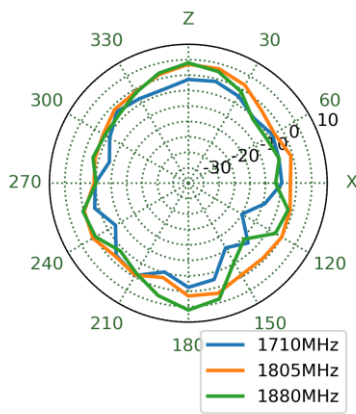

YZ Plane

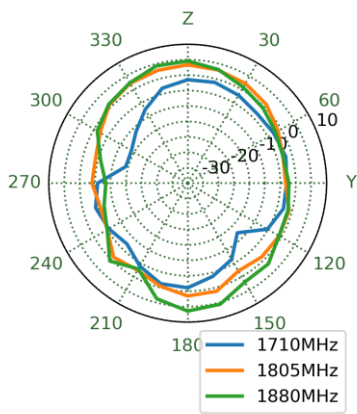

1920MHz

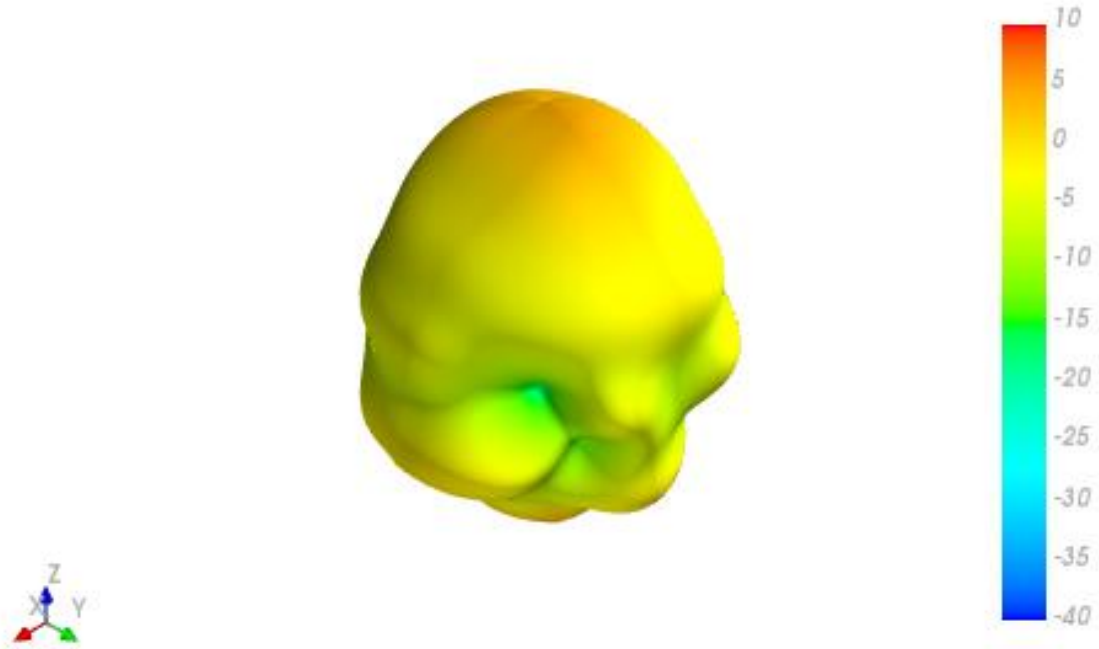

XY Plane

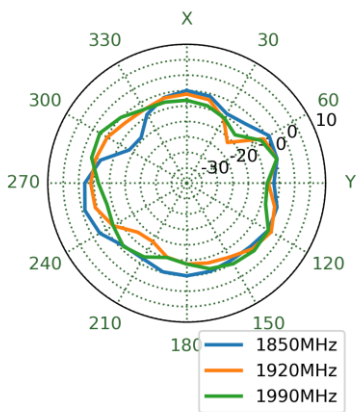

XZ Plane

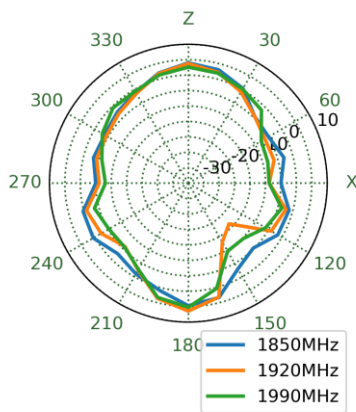

YZ Plane

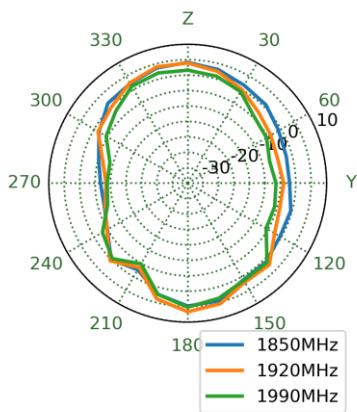

1990MHz

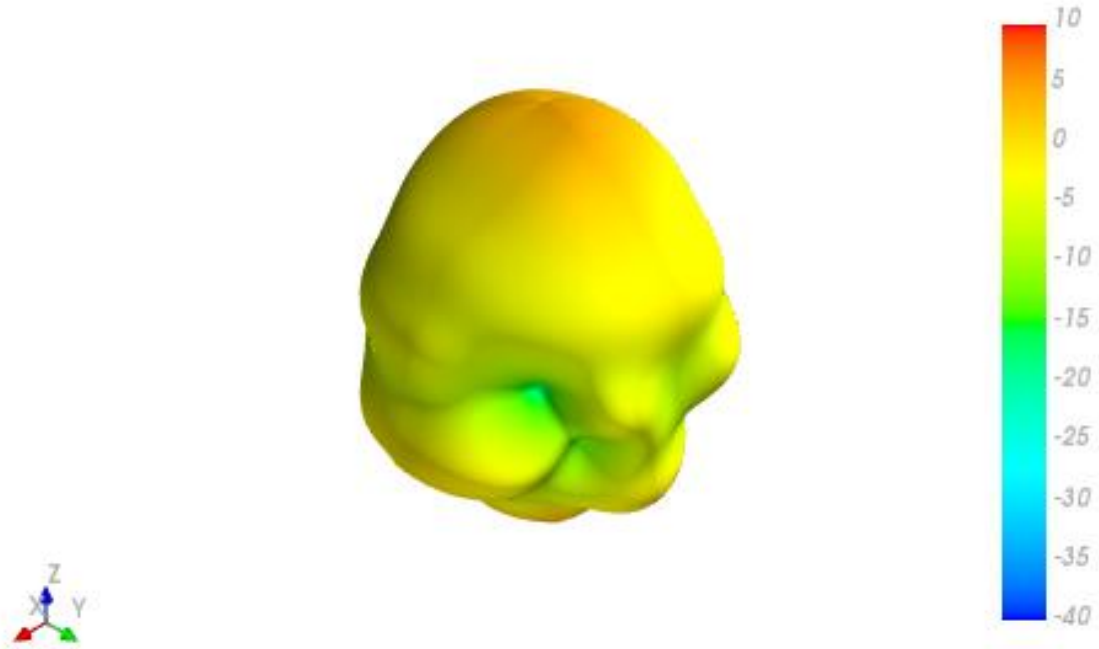

XY Plane

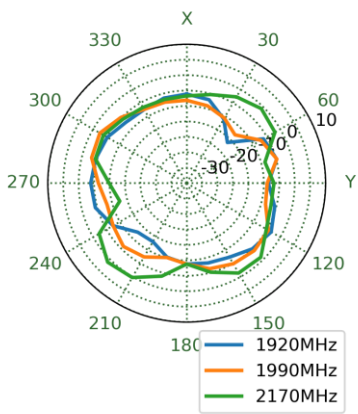

XZ Plane

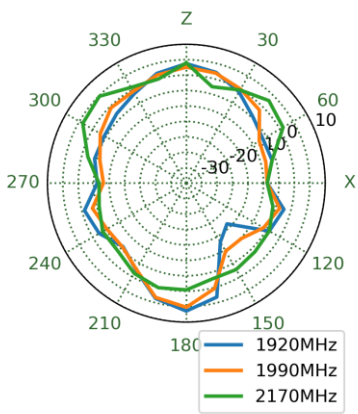

YZ Plane

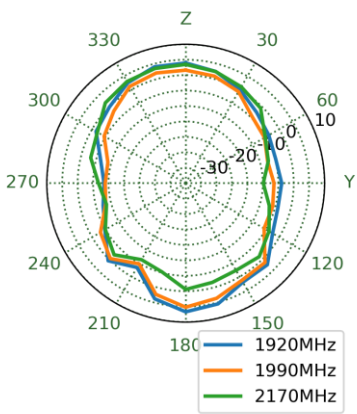

2595MHz

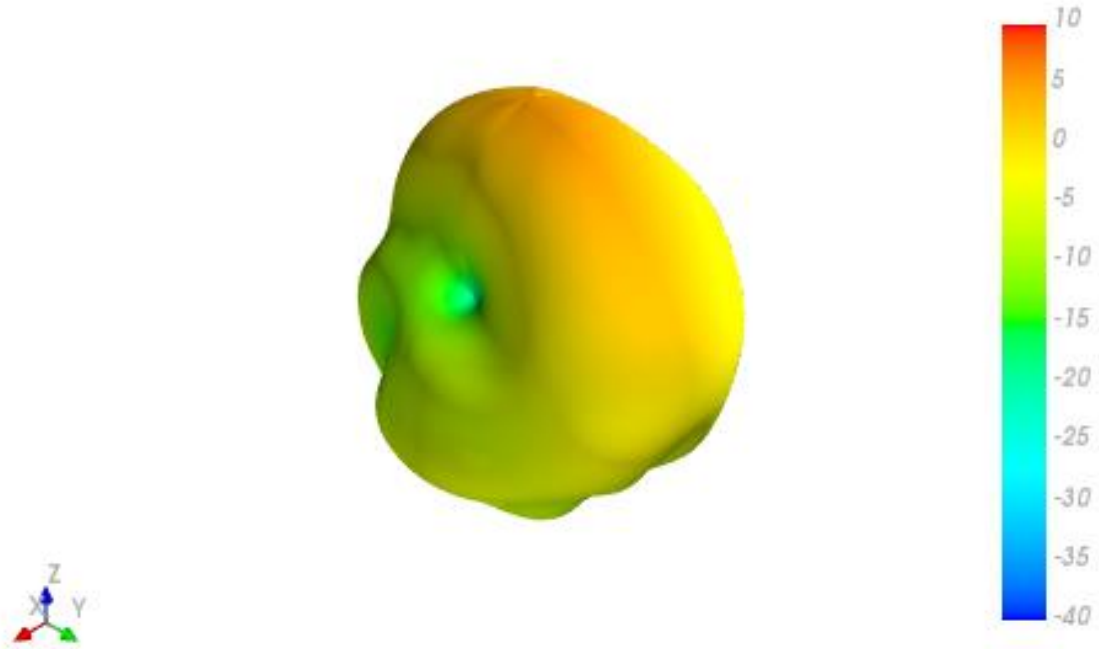

XY Plane

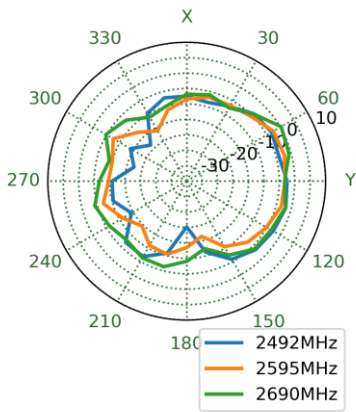

XZ Plane

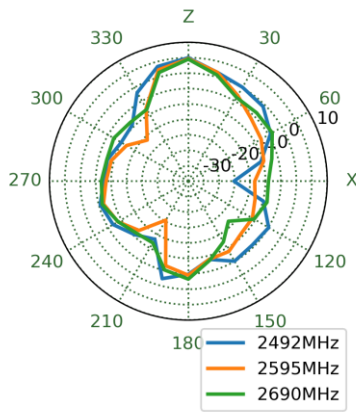

YZ Plane

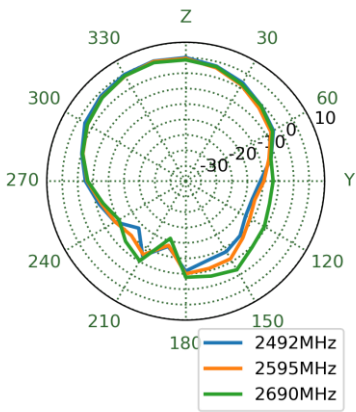

3550MHz

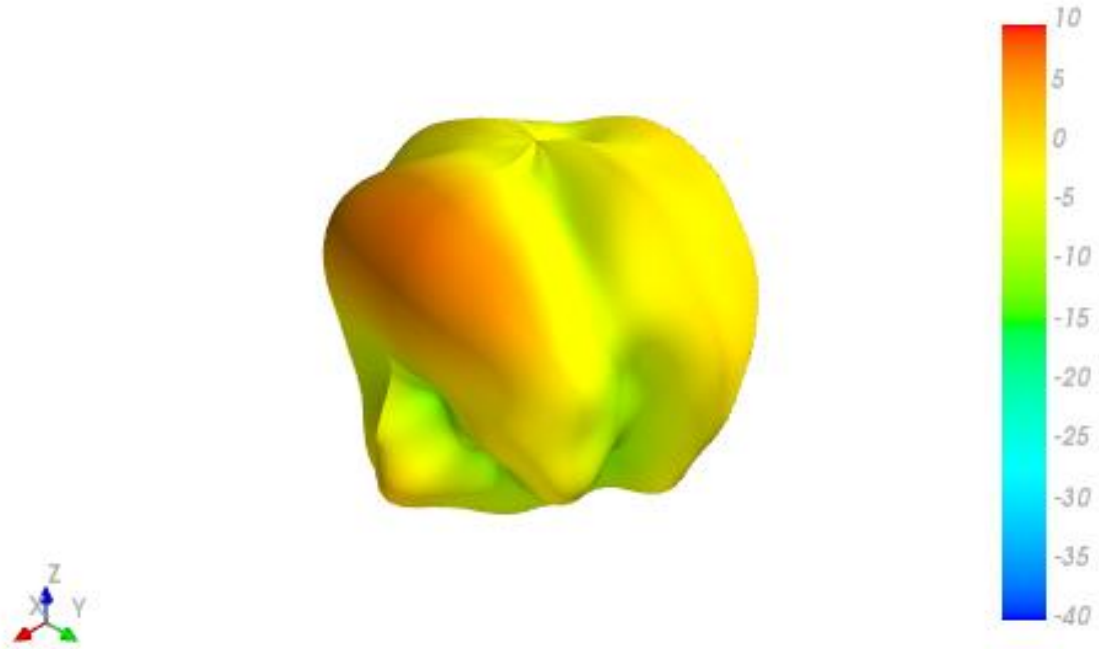

XY Plane

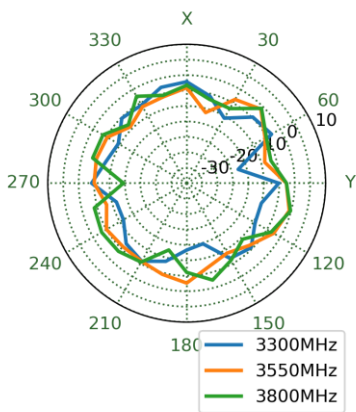

XZ Plane

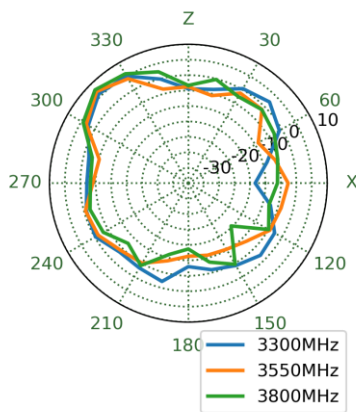

YZ Plane

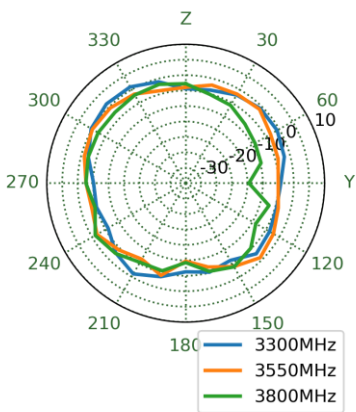

5530MHz

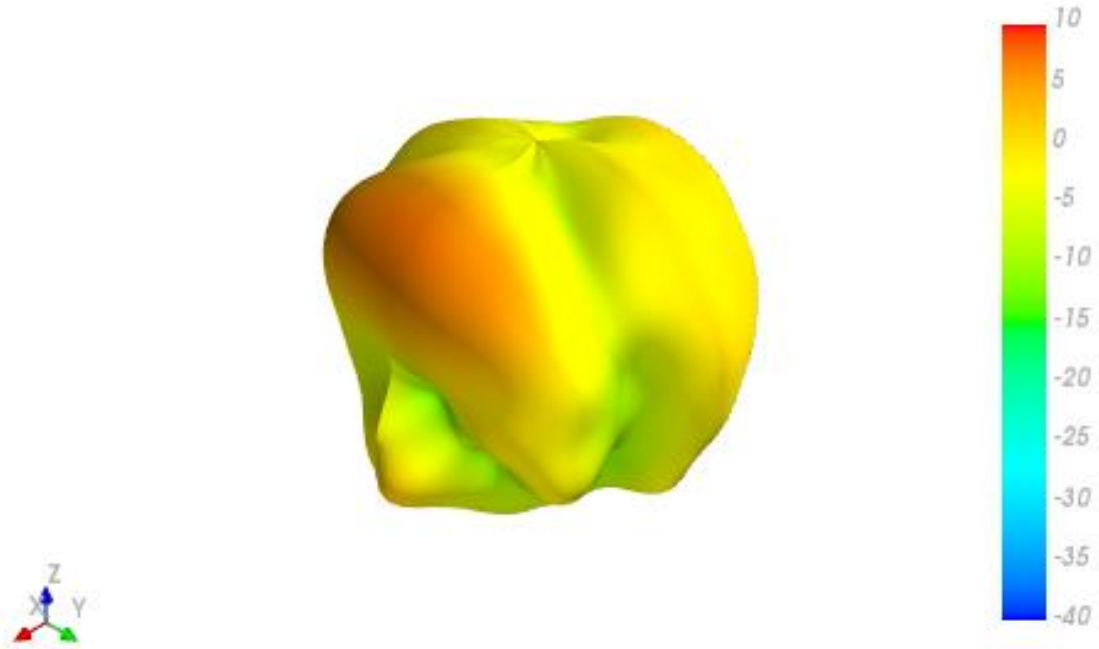

XY Plane

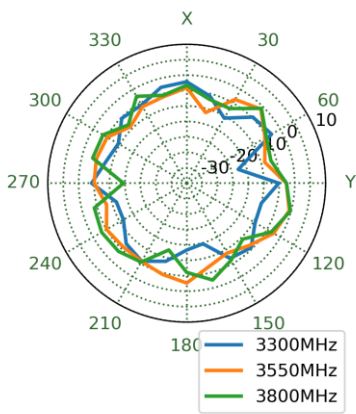

XZ Plane

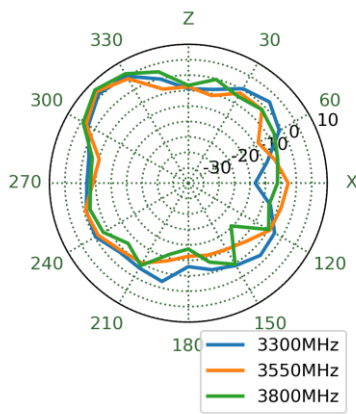

YZ Plane

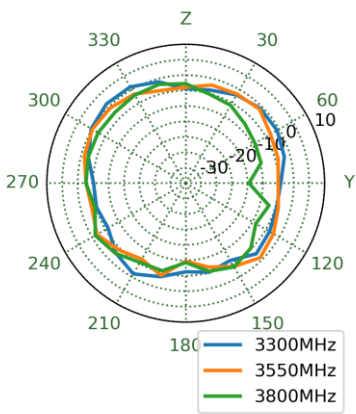

4.3 Test Setup – 30*30cm Ground Plane



4.2 Cellular 3D and 2D Radiation Patterns

652MHz

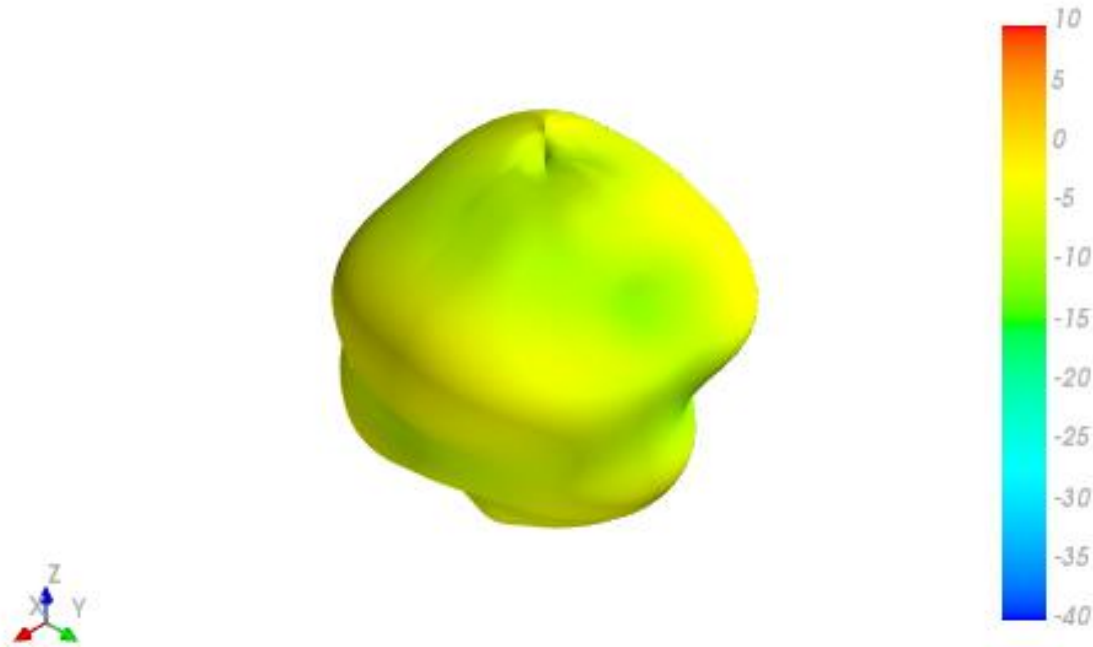

XY Plane

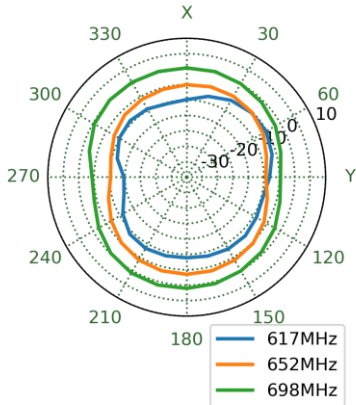

XZ Plane

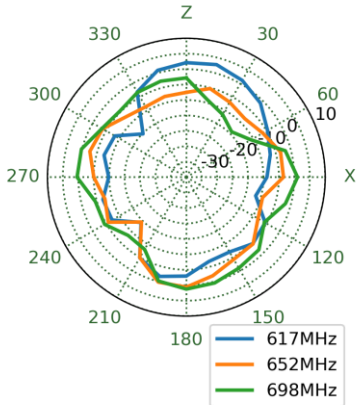

YZ Plane

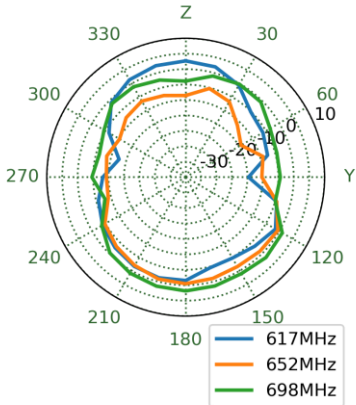

751MHz

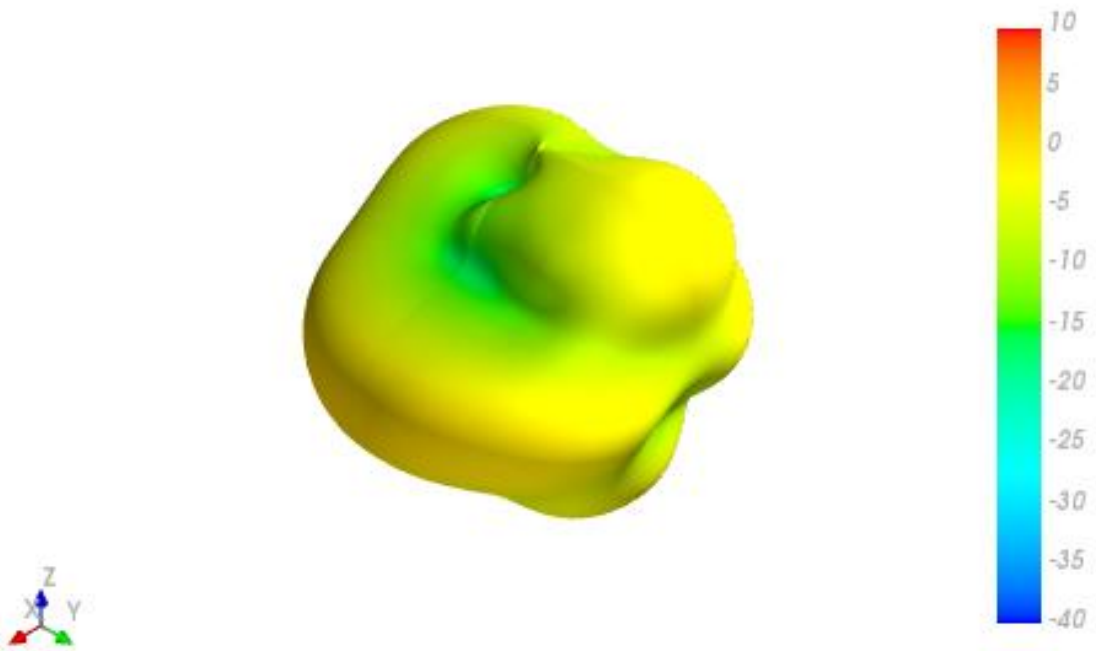

XY Plane

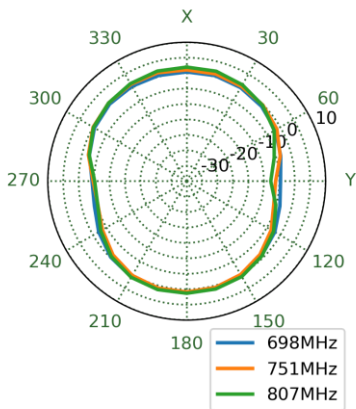

XZ Plane

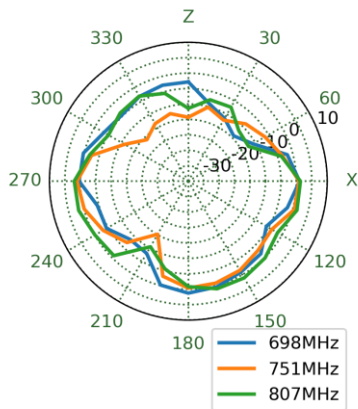

YZ Plane

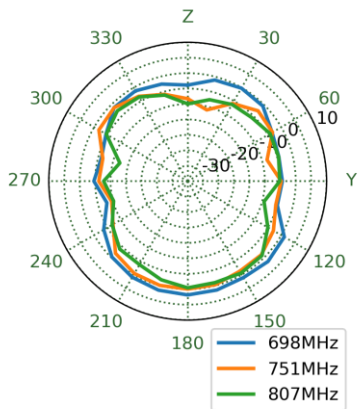

890MHz

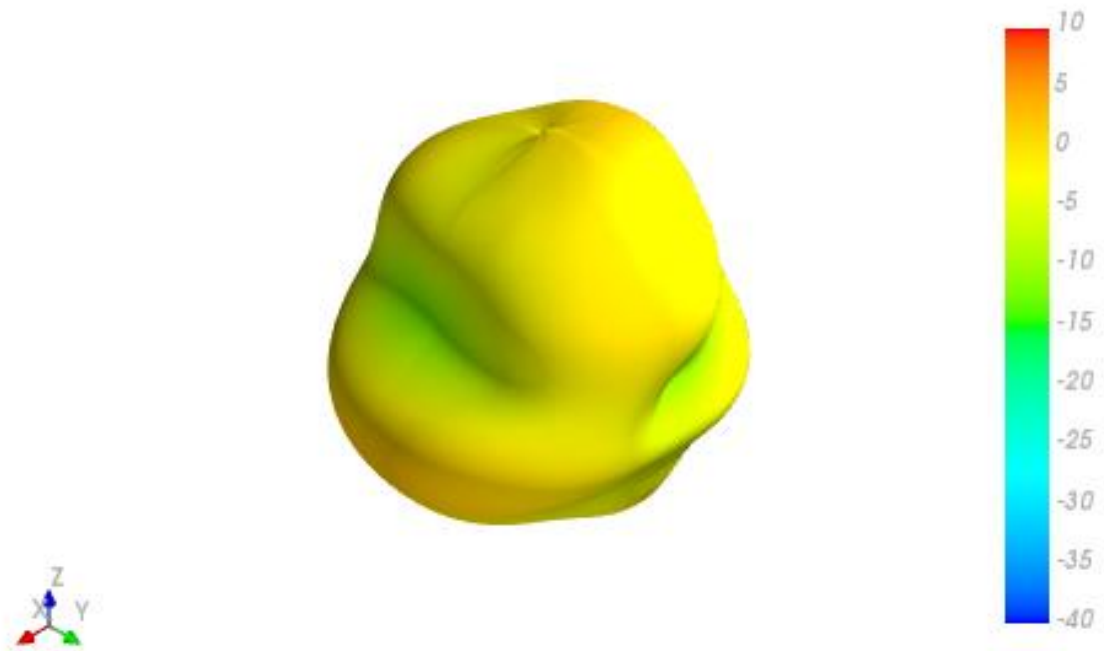

XY Plane

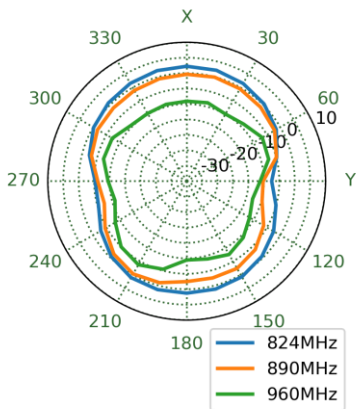

XZ Plane

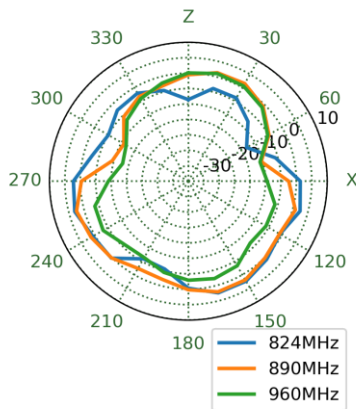

YZ Plane

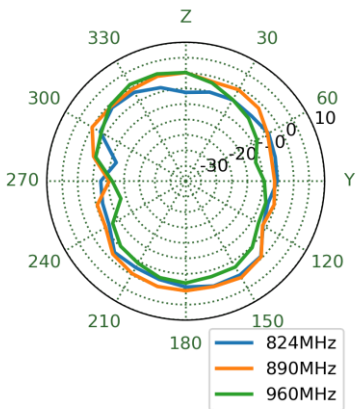

1470MHz

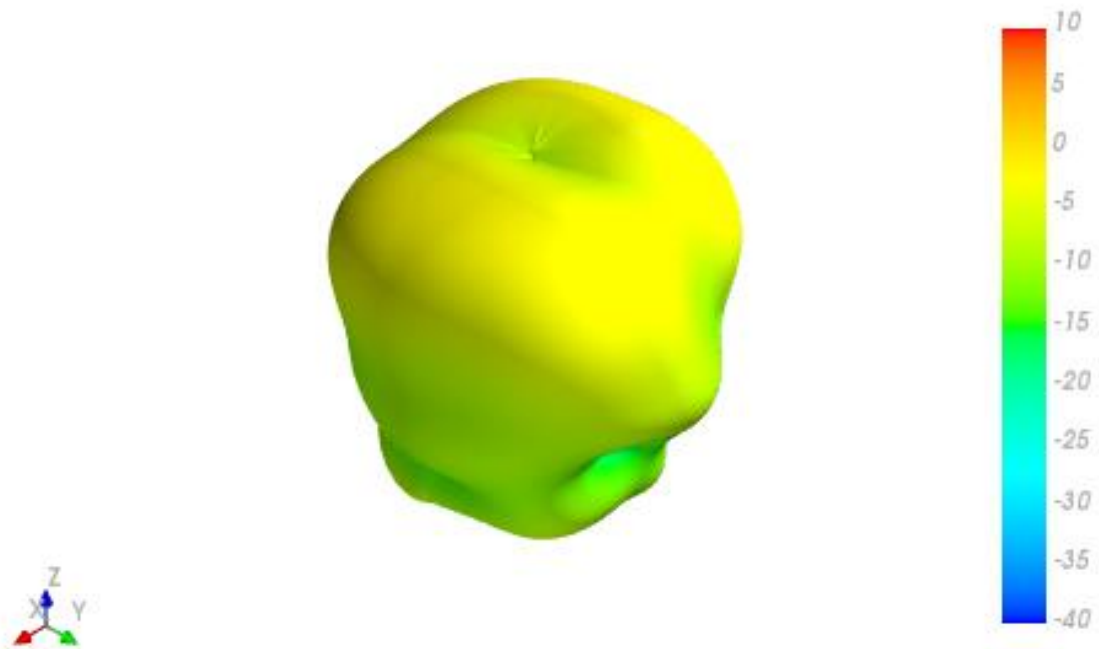

XY Plane

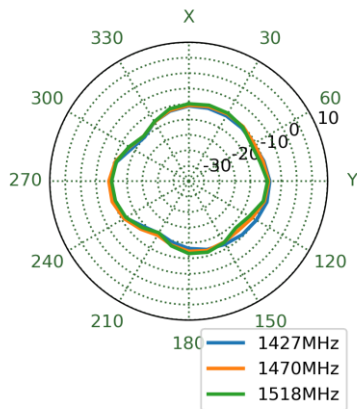

XZ Plane

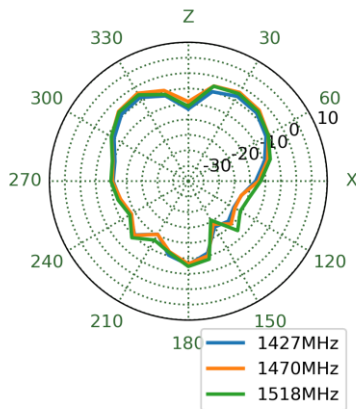

YZ Plane

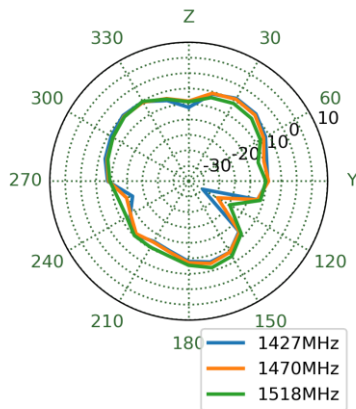

1805MHz

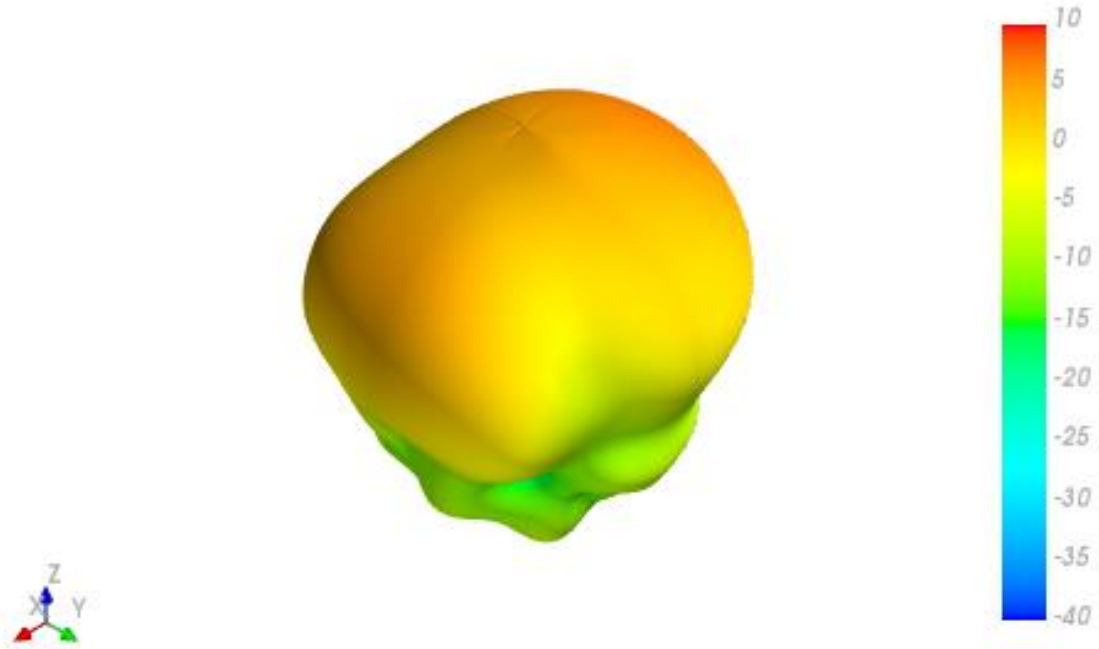

XY Plane

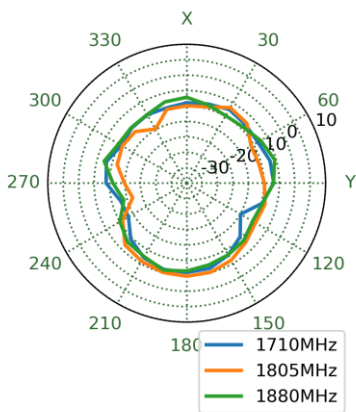

XZ Plane

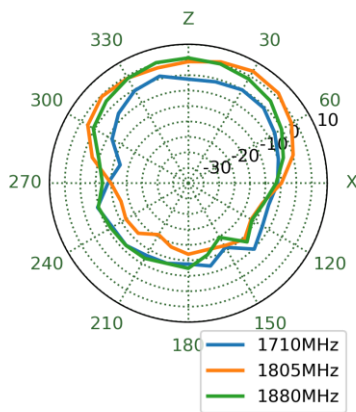

YZ Plane

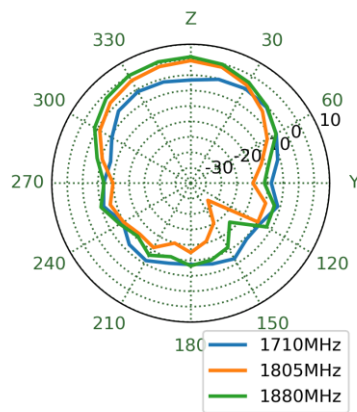

1920MHz

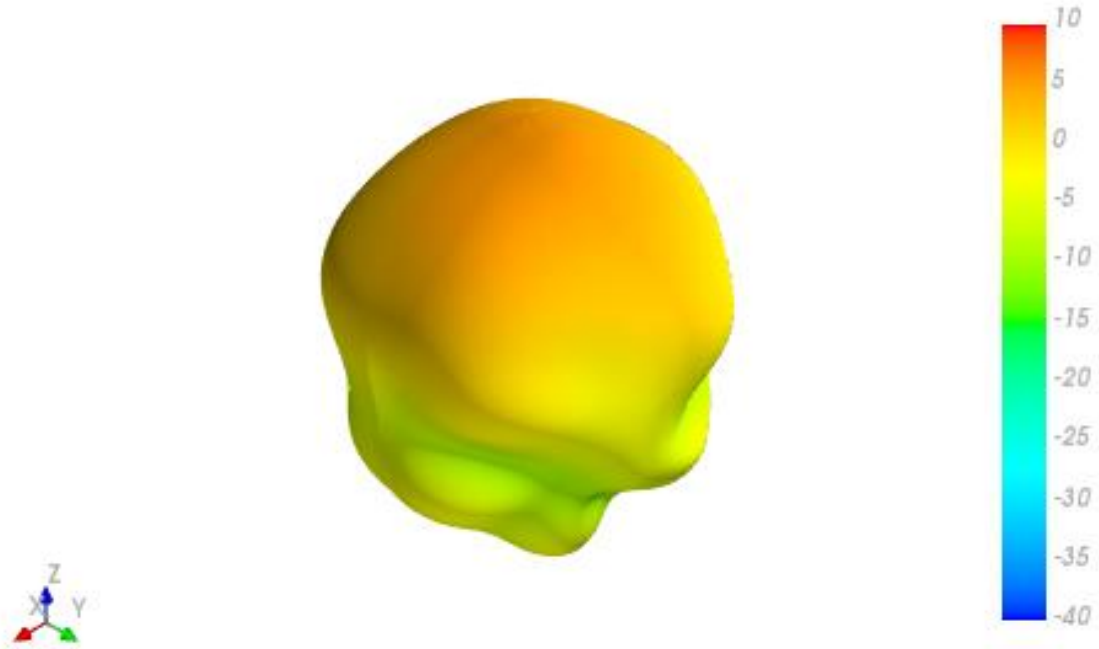

XY Plane

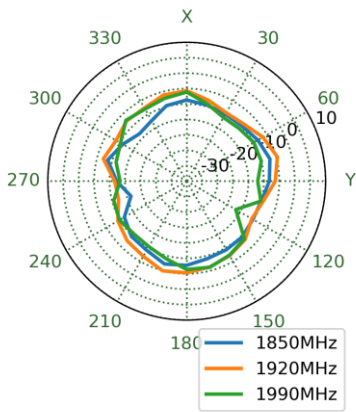

XZ Plane

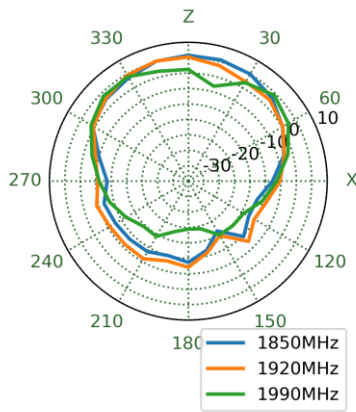

YZ Plane

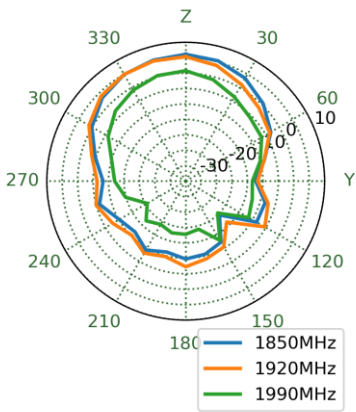

1990MHz

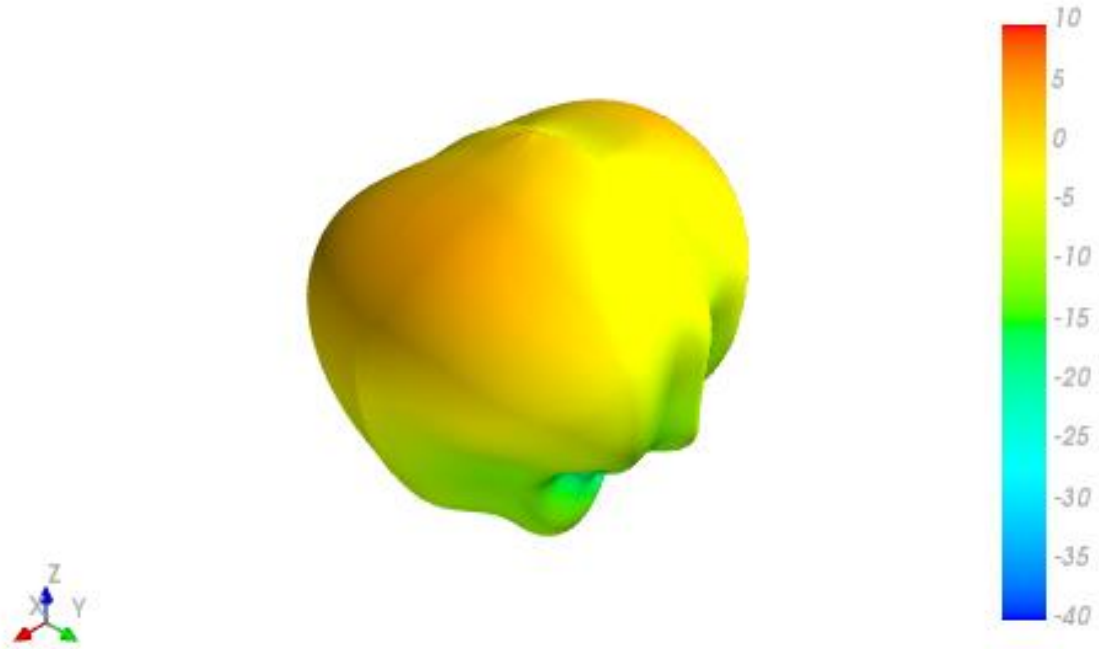

XY Plane

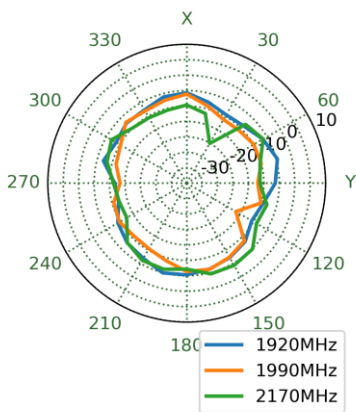

XZ Plane

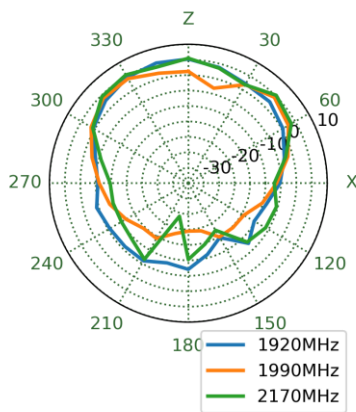

YZ Plane

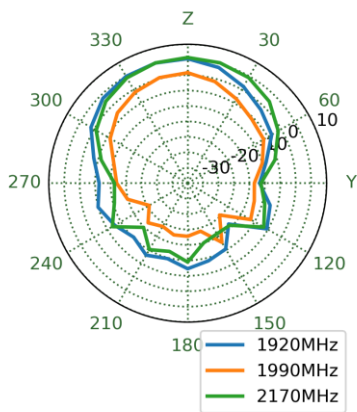

2595MHz

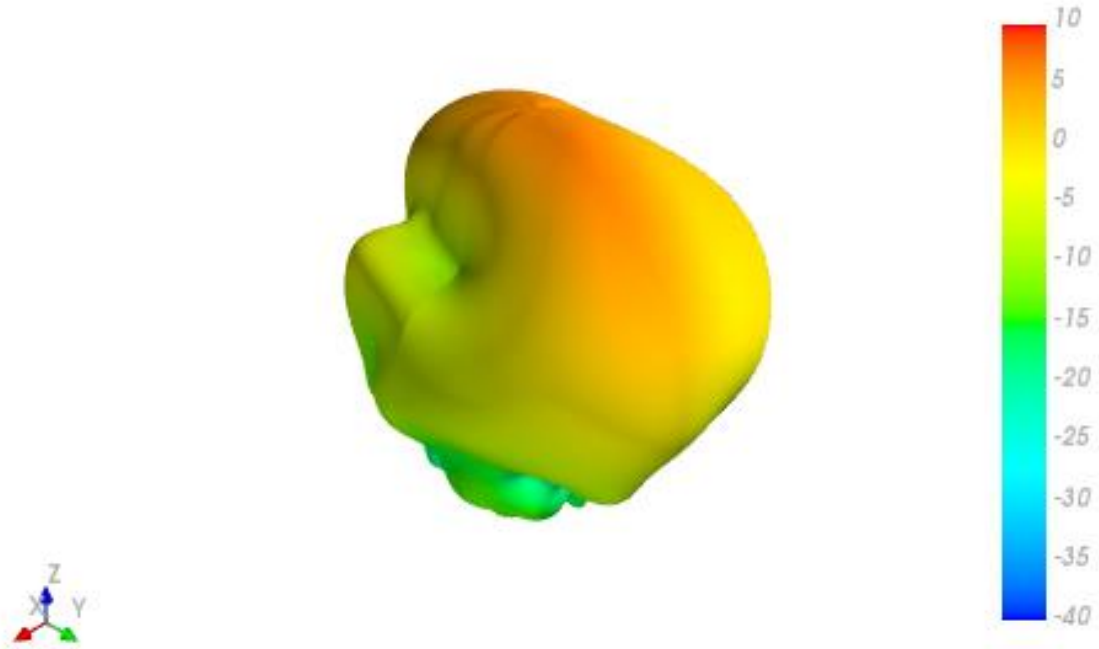

XY Plane

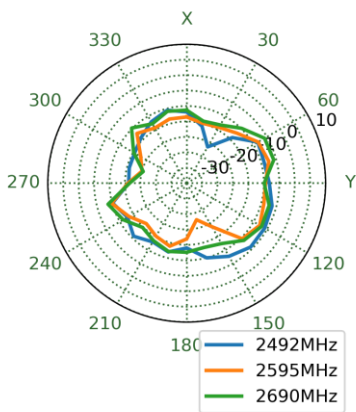

XZ Plane

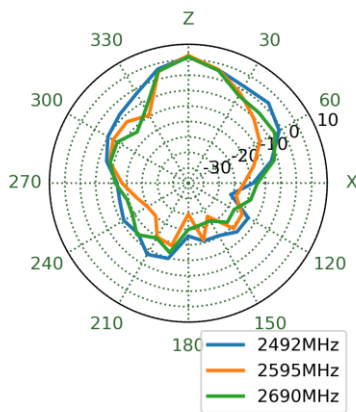

YZ Plane

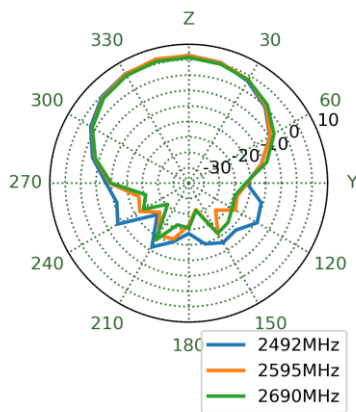

3550MHz

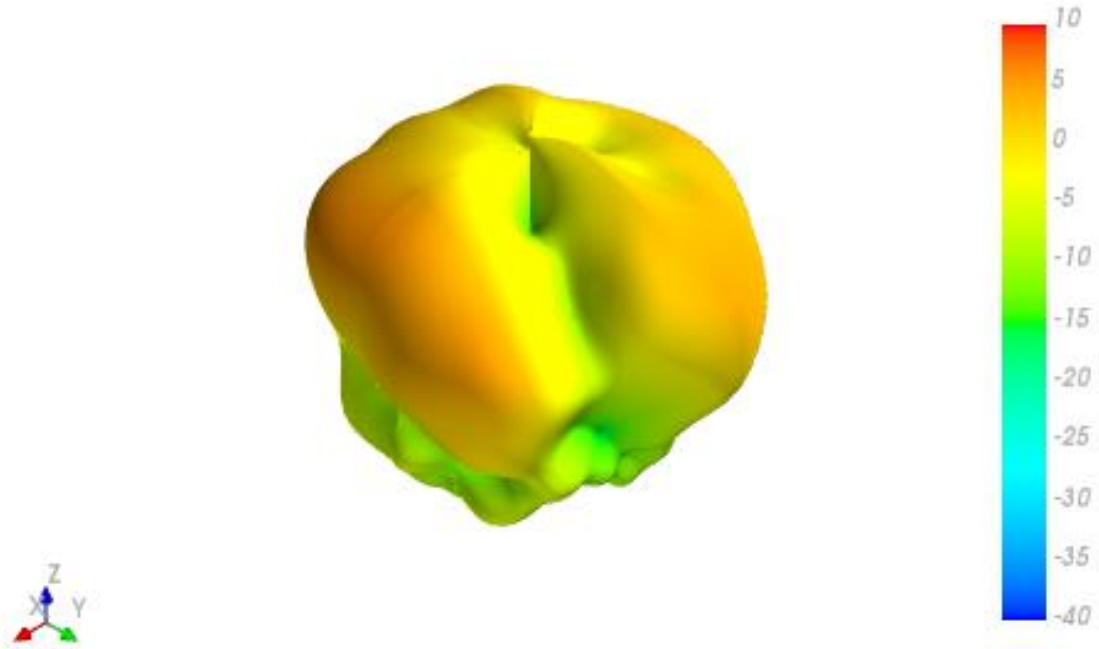

XY Plane

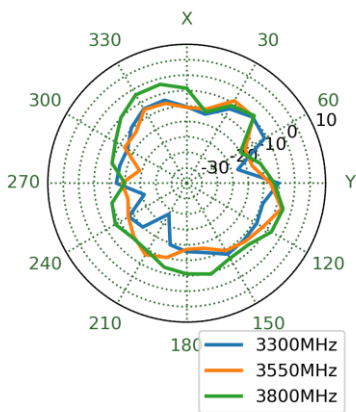

XZ Plane

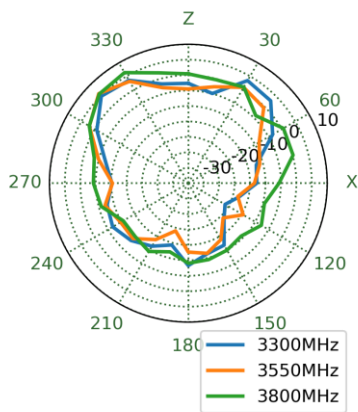

YZ Plane

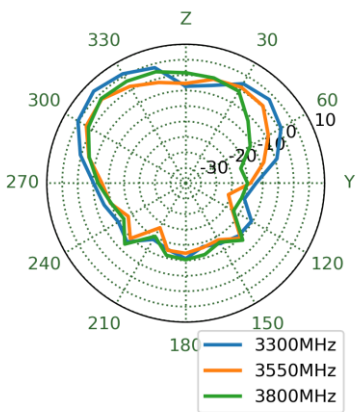

5530MHz

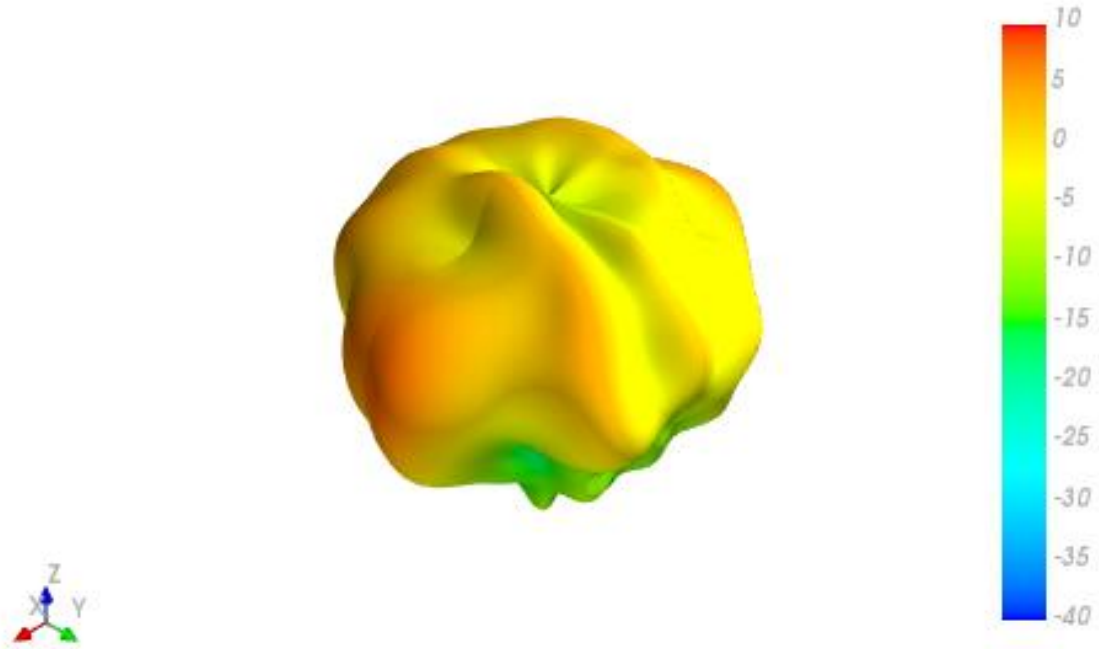

XY Plane

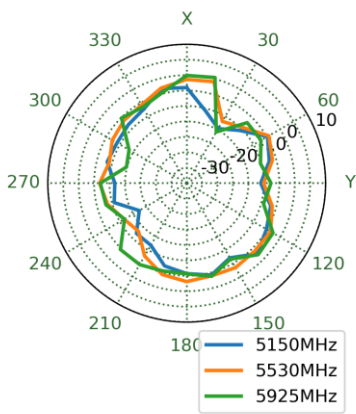

XZ Plane

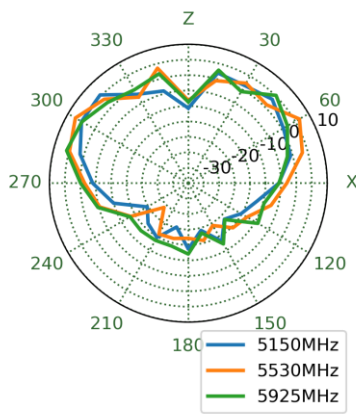

YZ Plane

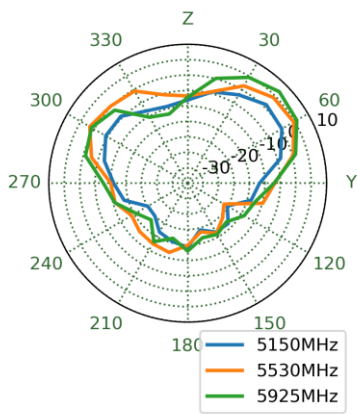

5. Mechanical Drawing (Units: mm)

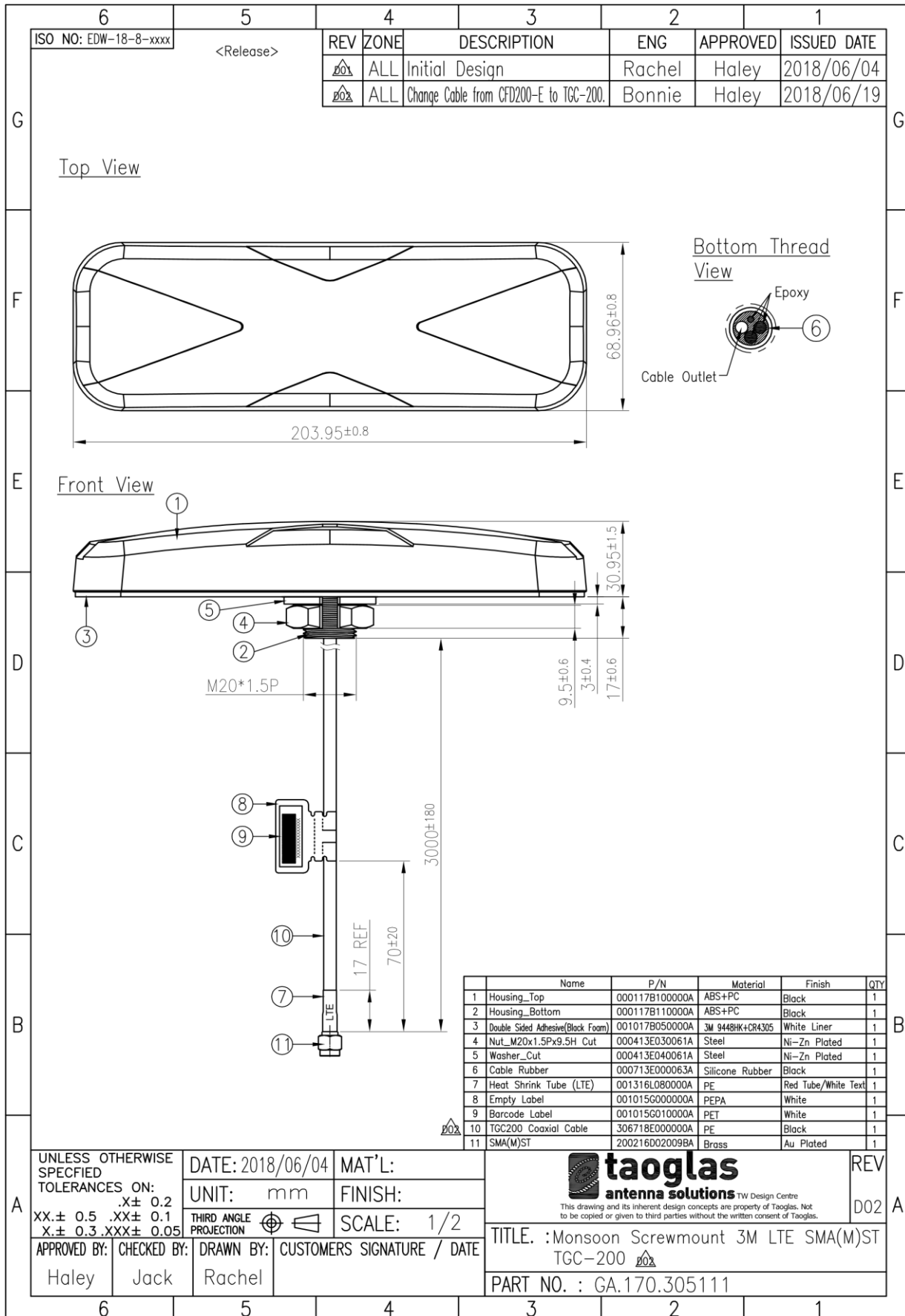

6. Packaging

1pc GA.170.305111 per PE Bag
 PE Bag Dimensions - 300*200mm
 Weight - 410g



18 pcs GA.170.305111 per Carton
 Box Dimensions - 506*490*250mm
 Weight - 7.3Kg

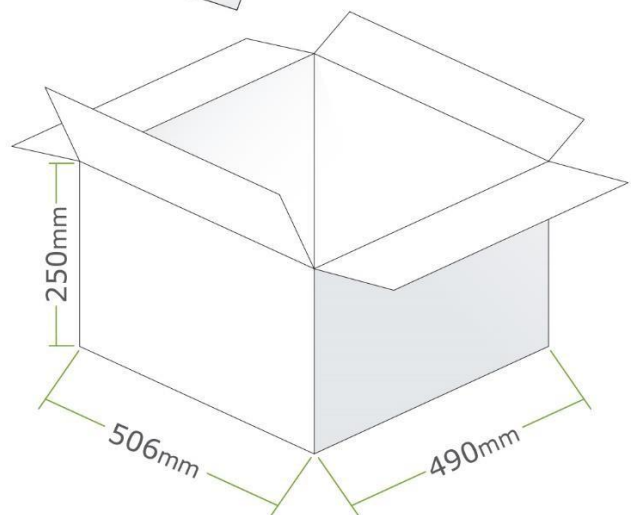

7. Application Note

7.1 Efficiency

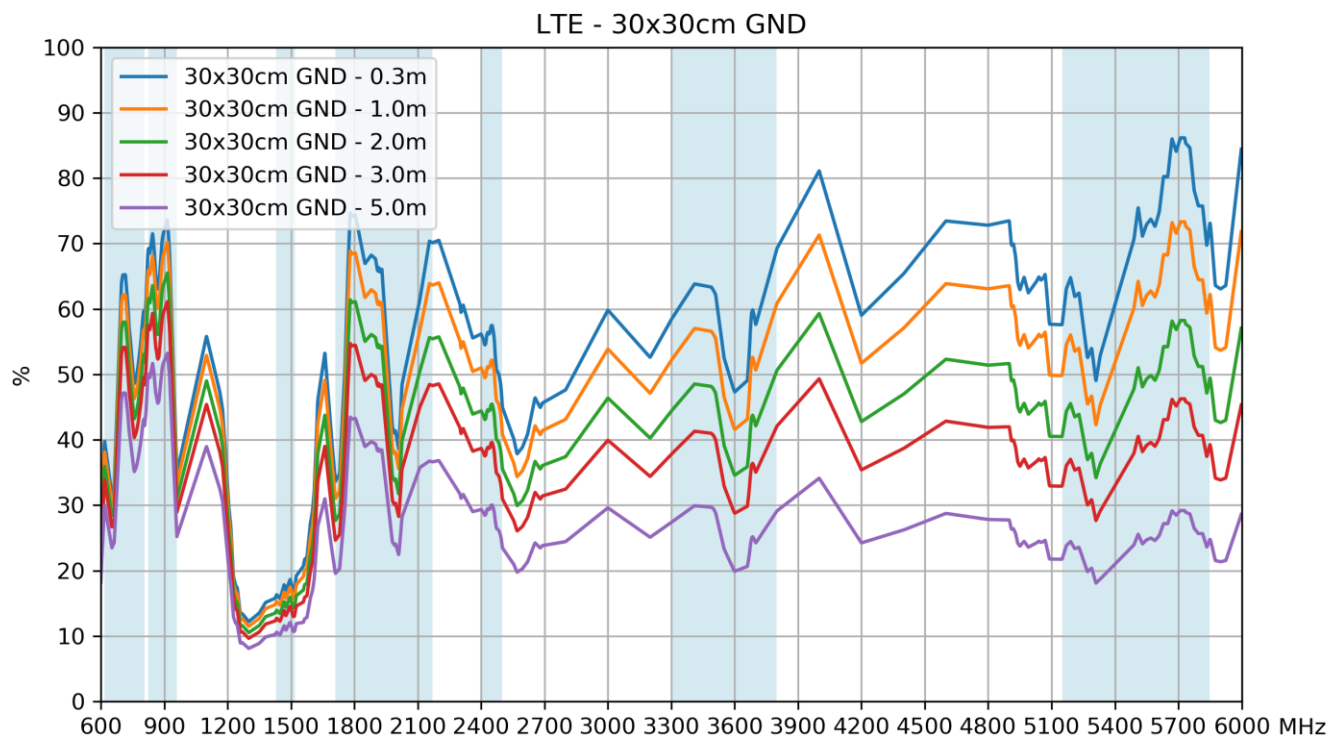
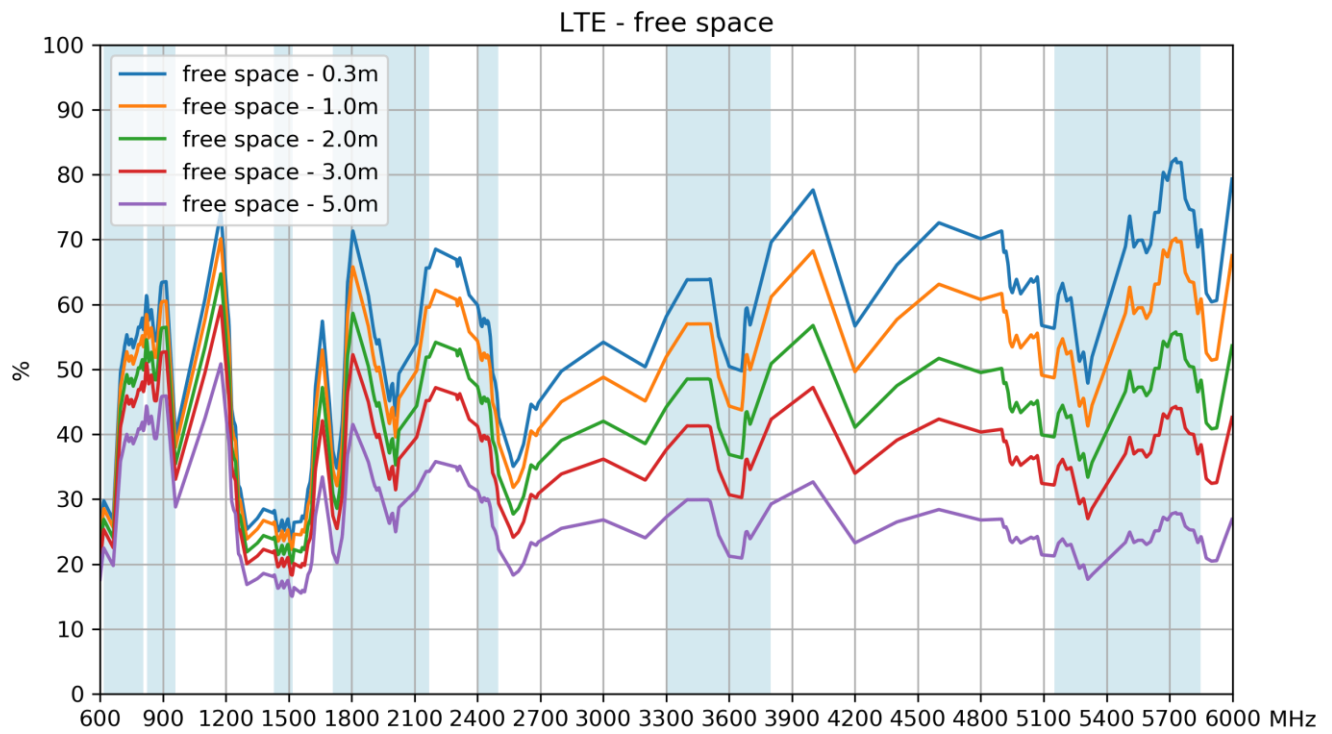

7.2 Average Gain

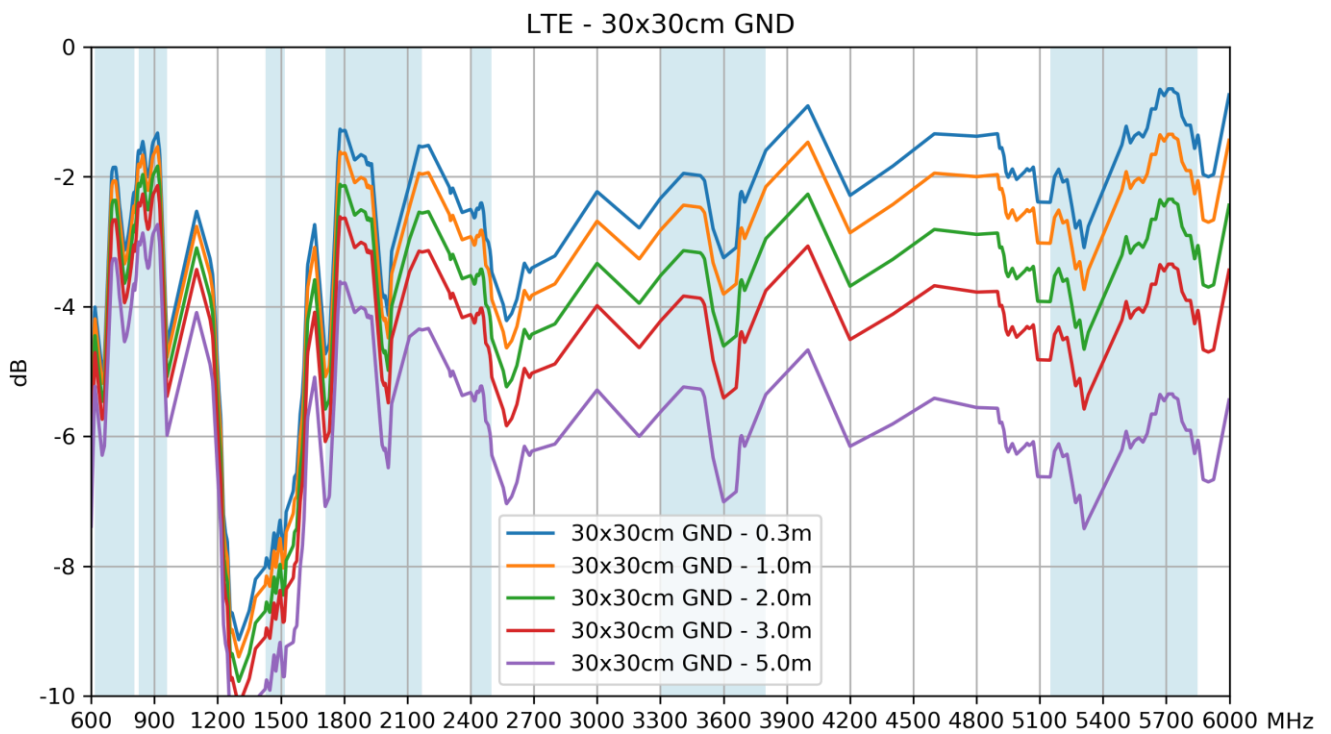
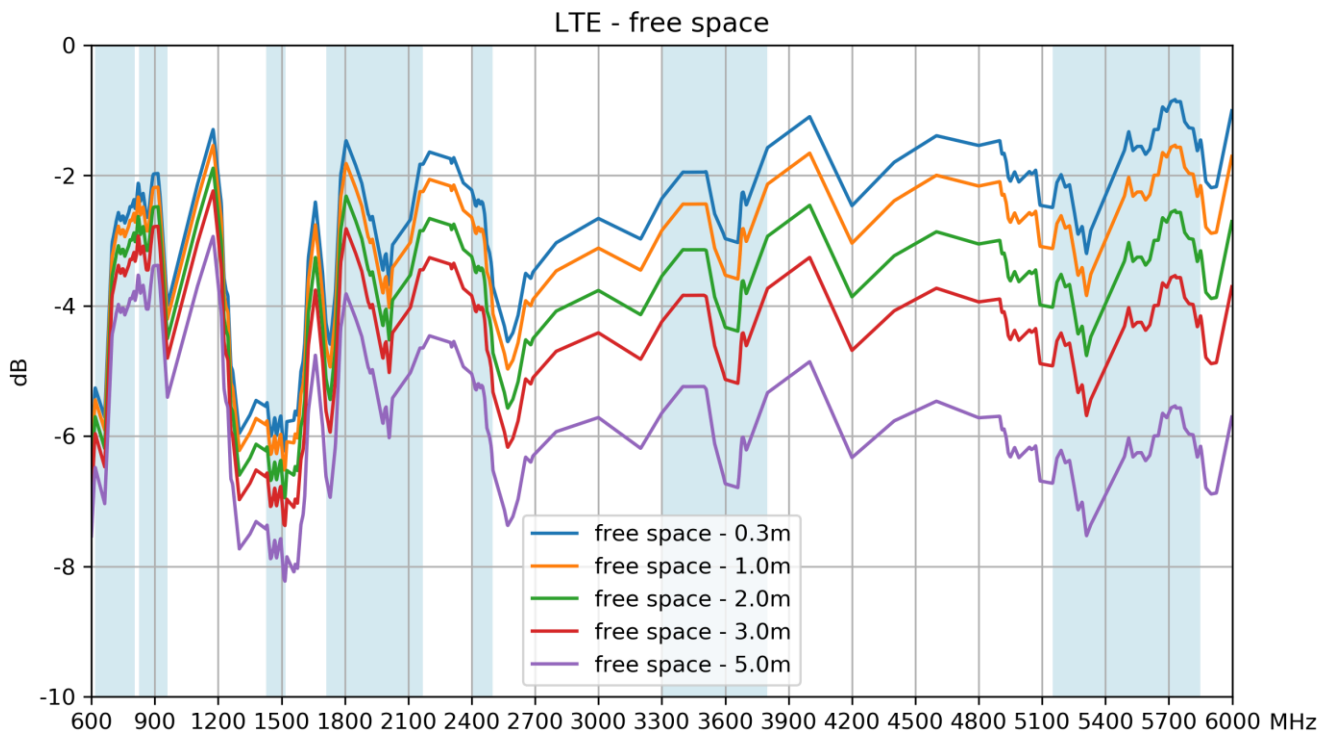

7.3 Peak Gain

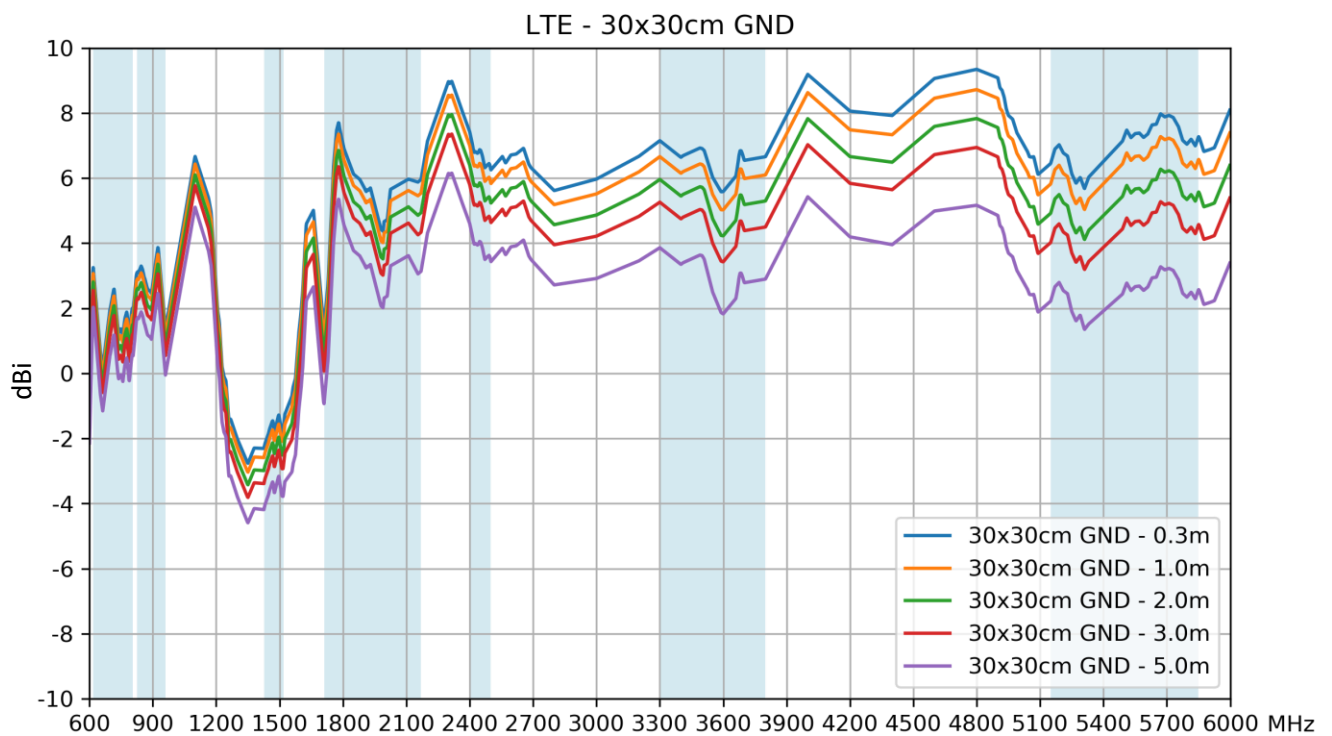
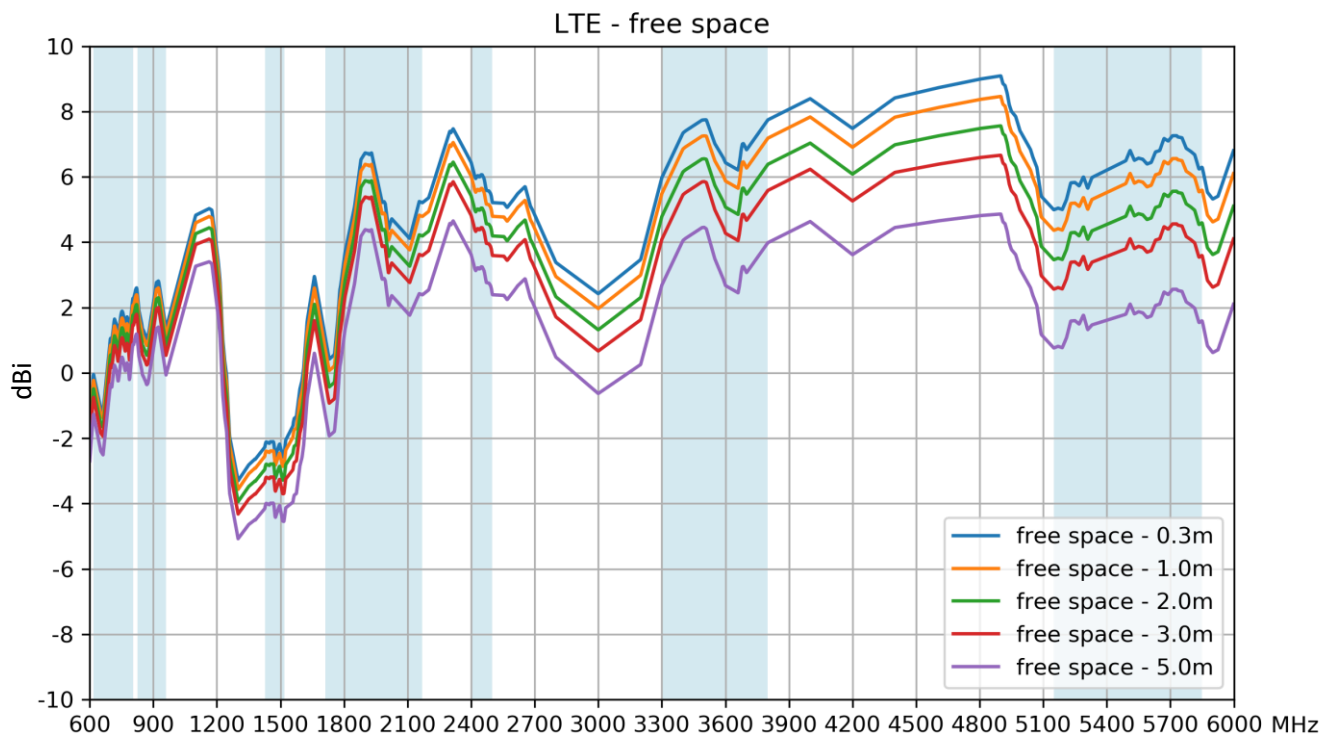

Changelog for the datasheet

SPE-18-8-073 – GA.170.305111

Revision: C (Current Version)

Date:	2023-07-11
Changes:	Updated electrical specifications
Changes Made by:	Cesar Sousa

Previous Revisions

Revision: B

Date:	2020-02-11
Changes:	Updated to include 5G data
Changes Made by:	Jack Conroy

Revision: A (Original First Release)

Date:	2018-08-01
Notes:	
Author:	Jack Conroy



TAOGLAS®

www.taoglas.com

