



TAOGLAS®



Datasheet

Synergy X 5-in-1

Part No:
MA1555.A.001

Description

Synergy X Permanent Mount 5-in-1 combination antenna
1*Multi-band GNSS 2*5G/4G MIMO 2*Wi-Fi

Features:

Low-profile Housing with Screw Mount
2* LTE MIMO 600-6000MHz
2* WIFI MIMO 2.4GHz/5.8 GHz (Including Wi-Fi 6)
1* Multiband GNSS
Worldwide 5G/4G Bands
IP67 Waterproof Enclosure
Dims: Ø161.3mm * 67mm
350mm RG174 with SMA(M) connectors
RoHS & Reach Compliant

1.	Introduction	2
2.	Specification	3
3.	Antenna Characteristics	8
4.	Radiation Patterns	19
5.	Mechanical Drawing	96
6.	Installation Instructions	97
7.	Packaging	99
<hr/>		
	Changelog	100

Taoglas makes no warranties based on the accuracy or completeness of the contents of this document and reserves the right to make changes to specifications and product descriptions at any time without notice. Taoglas reserves all rights to this document and the information contained herein. Reproduction, use or disclosure to third parties without express permission is strictly prohibited.



1. Introduction



The Taoglas Synergy X MA1555 is a 5-in-1 next-generation permanent mount antenna designed for vehicle roof applications. It has a fully IP67 rated waterproof robust PC enclosure and base. The 5 antennas inside support 5G/4G, Multi-Band GNSS, Wi-Fi (2.4GHz/5GHz). The Synergy X is the first Permanent Mount combination antenna to support multi-band GNSS, allowing for more precise tracking in applications where navigation and positioning are critical

This outstanding patent-pending antenna delivers powerful MIMO antenna technology for 5G/4G, Wi-Fi 2.4/5.8GHz 802.11n and the emerging 802.11ac, and an optimized multi-band GNSS antenna for location. The 5G/4G antennas also include backward compatibility to work at most worldwide 2G and 3G bands and also cover all NB-IoT and CAT-M/LTE-M for low power applications.

Typical Applications:

- Next Generation OEM Automotive Connectivity
- Multimedia, Navigation and Telematics Systems
- V2V, V2X and Fleet Management Applications
- Routers and Gateways
- First Responder
- Autonomous Vehicles and UAVs

The MA1555 is ideal for applications that require highly sophisticated antennas for real-time streaming applications that demand high-speed video uplink and downlink into the cabin of the vehicle. These challenges are resolved by the highly efficient, high gain MIMO antennas, with high isolation, all of which is necessary to achieve the required signal to noise ratio and throughput.

The MA1505 can also be customized for your particular wireless application and frequency band, subject to NRE and MOQ. There are 4 x RG-174 cables, terminating in SMA(M) connectors for 5G/4G MIMO 2X2, and SMA(M) for Wi-Fi MIMO 2X2. There is an RG-174 cable for GNSS terminating in an SMA(M) connector.

All cable lengths and connector types are fully customizable. The Synergy MA1505 can be supplied with low loss TGC-200 cable extensions for longer cable runs. Contact your regional Taoglas customer support team for more information.

2. Specification

LTE Electrical										
Band	Frequency (MHz)	MIMO	Measurement	Efficiency (%)	Average Gain (dB)	Peak Gain (dBi)	Impedance	Polarization	Radiation Pattern	Max. input power
5G NR/4G Band 71	617-698	MIMO 1	Free Space	48.7	-3.13	1.49	50 Ω	Linear	Omni	2W
			Ground Plane	21.2	-6.73	-0.15				
		MIMO 2	Free Space	45.1	-3.46	0.53				
			Ground Plane	18.6	-7.31	-0.47				
4G/3G Band 12,13,14,17,28,29	698-806	MIMO 1	Free Space	47.0	-3.28	1.45				
			Ground Plane	30.0	-5.23	-0.22				
		MIMO 2	Free Space	45.9	-3.39	0.74				
			Ground Plane	28.5	-5.45	-1.24				
4G/3G/NB-IoT/Cat M Band 5,8,18,19,20,26,27	824-960	MIMO 1	Free Space	52.4	-2.80	1.51				
			Ground Plane	42.5	-3.72	2.85				
		MIMO 2	Free Space	51.6	-2.88	1.29				
			Ground Plane	42.1	-3.76	3.34				
5G NR/4G Band 21,32,74,75,76	1427-1518	MIMO 1	Free Space	58.6	-2.32	2.79				
			Ground Plane	53.6	-2.71	3.00				
		MIMO 2	Free Space	56.3	-2.50	1.74				
			Ground Plane	54.0	-2.68	3.18				
4G/3G Band 1,2,3,4,9,23,25,35,39,66	1710-2200	MIMO 1	Free Space	50.8	-2.94	2.72				
			Ground Plane	50.5	-2.96	4.54				
		MIMO 2	Free Space	47.6	-3.23	1.19				
			Ground Plane	48.2	-3.17	3.54				
4G/3G Band 7,30,38,40,41	2300-2690	MIMO 1	Free Space	64.7	-1.89	4.20				
			Ground Plane	68.0	-1.67	5.65				
		MIMO 2	Free Space	64.2	-1.93	4.13				
			Ground Plane	67.0	-1.74	4.94				
5G NR/4G Band 22,42,48,77,78,79	3300-5000	MIMO 1	Free Space	53.4	-2.73	6.00				
			Ground Plane	52.1	-2.83	6.98				
		MIMO 2	Free Space	61.1	-2.14	5.44				
			Ground Plane	62.6	-2.03	8.11				
LTE5200/Wi-Fi5800	5150-5925	MIMO 1	Free Space	64.8	-1.89	7.32				
			Ground Plane	62.3	-2.05	9.29				
		MIMO 2	Free Space	41.5	-3.82	4.82				
			Ground Plane	50.5	-2.97	8.16				

5G/4G Bands						
Band Number	5GNR / FR1 / LTE / LTE-Advanced / WCDMA / HSPA / HSPA+ / TD-SCDMA					
	Uplink	Downlink	MIMO1_Free Space	MIMO1_Ground Plane	MIMO2_Free Space	MIMO2_Ground Plane
B1	1920 to 1980	2110 to 2170	✓	✓	✓	✓
B2	1850 to 1910	1930 to 1990	✓	✓	✓	✓
B3	1710 to 1785	1805 to 1880	✓	✓	✓	✓
B4	1710 to 1755	2110 to 2155	✓	✓	✓	✓
B5	824 to 849	869 to 894	✓	✓	✓	✓
B7	2500 to 2570	2620 to 2690	✓	✓	✓	✓
B8	880 to 915	925 to 960	✓	✓	✓	✓
B9*	1749.9 to 1784.9	1844.9 to 1879.9	✓	✓	✓	✓
B11	1427.9 to 1447.9	1475.9 to 1495.9	✓	✓	✓	✓
B12	699 to 716	729 to 746	✓	✓	✓	✓
B13	777 to 787	746 to 756	✓	✓	✓	✓
B14	788 to 798	758 to 768	✓	✓	✓	✓
B17	704 to 716	734 to 746	✓	✓	✓	✓
B18	815 to 830	860 to 875	✓	✓	✓	✓
B19	830 to 845	875 to 890	✓	✓	✓	✓
B20	832 to 862	791 to 821	✓	✓	✓	✓
B21	1447.9 to 1462.9	1495.9 to 1510.9	✓	✓	✓	✓
B22*	3410 to 3490	3510 to 3590	✓	✓	✓	✓
B23*	2000 to 2020	2180 to 2200	✓	✓	✓	✓
B24	1626.5 to 1660.5	1525 to 1559	✓	✓	✓	✓
B25	1850 to 1915	1930 to 1995	✓	✓	✓	✓
B26	814 to 849	859 to 894	✓	✓	✓	✓
B27*	807 to 824	852 to 869	✓	✓	✓	✓
B28	703 to 748	758 to 803	✓	✓	✓	✓
B29		717 to 728	✓	✓	✓	✓
B30	2305 to 2315	2350 to 2360	✓	✓	✓	✓
B31	452.5 to 457.5	462.5 to 467.5	*	*	*	*
B32		1452 to 1496	✓	✓	✓	✓
B34		2010 to 2025	✓	✓	✓	✓
B35		1850 to 1910	✓	✓	✓	✓
B36		1930 to 1990	✓	✓	✓	✓
B37		1910 to 1930	✓	✓	✓	✓
B38		2570 to 2620	✓	✓	✓	✓
B39		1880 to 1920	✓	✓	✓	✓
B40		2300 to 2400	✓	✓	✓	✓
B41		2496 to 2690	✓	✓	✓	✓
B42		3400 to 3600	✓	✓	✓	✓
B43		3600 to 3800	✓	✓	✓	✓
B45		1447 to 1467	✓	✓	✓	✓
B46		5150 to 5925	✓	✓	✓	✓
B47		5855 to 5925	✓	✓	✓	✓
B48		3550 to 3700	✓	✓	✓	✓
B49		3550 to 3700	✓	✓	✓	✓
B50		1432 to 1517	✓	✓	✓	✓
B51		1427 to 1432	✓	✓	✓	✓
B52		3300 to 3400	✓	✓	✓	✓
B53		2483.5 to 2495	✓	✓	✓	✓
B65	1920 to 2010	2110 to 2200	✓	✓	✓	✓
B66	1710 to 1780	2110 to 2200	✓	✓	✓	✓
B68	698 to 728	753 to 783	✓	✓	✓	✓
B69		2570 to 2620	✓	✓	✓	✓
B70	1695 to 1710	1995 to 2020	✓	✓	✓	✓
B71	663 to 698	617 to 652	✓	✓	✓	✓
B72	451 to 456	461 to 466	*	*	*	*
B73	450 to 455	460 to 465	*	*	*	*
B74	1427 to 1470	1475 to 1518	✓	✓	✓	✓
B75		1432 to 1517	✓	✓	✓	✓
B76		1427 to 1432	✓	✓	✓	✓
B77		3300 to 4200	✓	✓	✓	✓
B78		3300 to 3800	✓	✓	✓	✓
B79		4400 to 5000	✓	✓	✓	✓
B85	698 to 716	728 to 746	✓	✓	✓	✓
B87	410 to 415	420 to 425	*	*	*	*
B88	412 to 417	422 to 427	*	*	*	*

GNSS Frequency Bands					
GPS	L1 1575.42 MHz	L2 1227.6 MHz	L5 1176.45 MHz		
	■	■	■		
GLONASS	G1 1602 MHz	G2 1248 MHz	G3 1207 MHz		
	■	■	■		
Galileo	E1 1575.24 MHz	E5a 1176.45 MHz	E5b 1201.5 MHz	E6 1278.75 MHz	
	■	■	■	■	
Bei Dou	B1C 1575.42 MHz	B1I 1561 MHz	B2a 1176.45 MHz	B2b 1207.14 MHz	B3 1268.52 MHz
	■	■	■	■	■
QZSS (Regional)	L1 1575.42 MHz	L2C 1227.6 MHz	L5 1176.45 MHz	L6 1278.75e6	
	■	■	■	■	
IRNSS (Regional)	L5 1176.45 MHz				
	■				
SBAS	L1/E1/B1 1575.42 MHz	L5/B2a/E5a 1176.45 MHz	G1 1602 MHz	G2 1248 MHz	G3 1207 MHz
	■	■	■	■	■

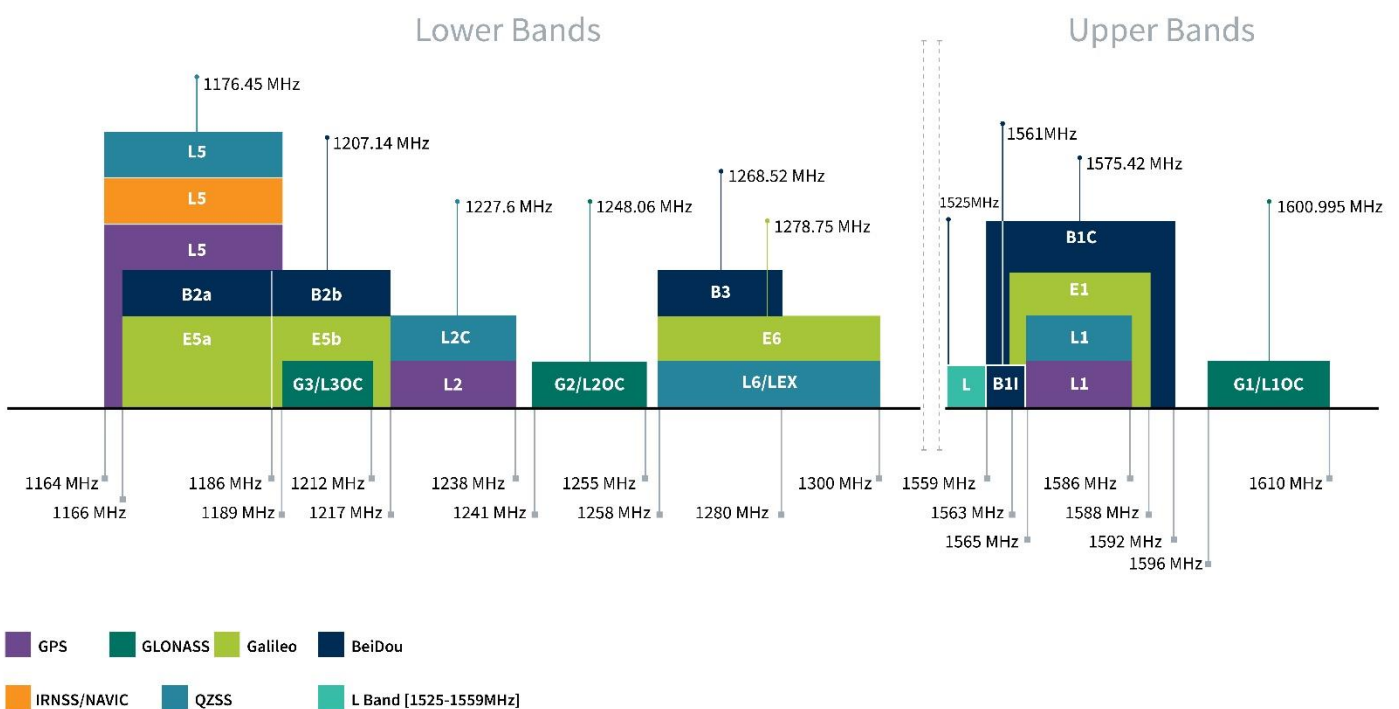

Frequency (MHz)	1176.45	1227.6	1278.75	1561	1575.42	1602
VSWR (max.)	2:1	1:1	1:1	2:1	2:1	2:1
Passive Antenna Gain at Zenith (dBi) (Without cable loss)	31.89	30.61	30.95	31.82	33.28	32.19
Axial Ratio (dB)	1.12	0.89	1.18	2.34	2.27	2.48
Group Delay Mean (ns)	12.15	5.99	11.11	34.35	26.89	30.67
Group Delay Variation (ns)	7	6	14	6	21	16
Polarization	RHCP					
Impedance	50 Ω					
Cable	350mm RG174					
Connector	SMA(M)					

LNA and Filter Electrical Properties

Frequency (MHz)	L5 1176.45	GAL E5b 1207	GPS L2 1227	L6/E6 1278.75	B1 1561	L1 1575.42
Gain (typical)	25 dB	26 dB	25 dB	22 dB	27 dB	28 dB
Noise Figure (typical)	4.0 dB	3.7 dB	3.8 dB	4.5 dB	3.1 dB	2.6 dB
Current Draw (typical)	< 20 mA					
Input Voltage	+1.8 to +5 VDC					
Out-Of-Band Attenuation (dB)	100 - 900 MHz			> 50		
	900 - 1000 MHz			> 30		
	1350 - 1520 MHz			> 25		
	1700 - 2000 MHz			> 35		
	2000 - 6000 MHz			> 45		

Wi-Fi Electrical										
Band	Frequency (MHz)	MIMO	Measurement	Efficiency (%)	Average Gain (dB)	Peak Gain (dBi)	Impedance	Polarization	Radiation Pattern	Max. input power
Wi-Fi2 2.4 GHz	2400-2500	MIMO 1	Free Space	55.4	-2.57	2.48	50 Ω	Linear	Omni	2W
			Ground Plane	59.4	-2.26	4.53				
		MIMO 2	Free Space	51.2	-2.91	2.82				
			Ground Plane	55.6	-2.55	3.97				
Wi-Fi5 5 GHz	5150-5850	MIMO 1	Free Space	61.2	-2.13	5.88				
			Ground Plane	55.2	-2.58	7.51				
		MIMO 2	Free Space	54.4	-2.64	5.43				
			Ground Plane	43.8	-3.59	6.67				

Mechanical	
Dimensions	Ø161.3mm * 67mm
Weight	535g
Material	PC
Connector	SMA (M)
Cable	RG-174 (Staggered lengths see ME drawing)

Environmental	
Protection	IP67
Temperature Range	-40°C to 85°C
Humidity	Non-condensing 65°C 95% RH
RoHS Compliant	Yes
REACH Compliant	Yes

3. Antenna Characteristics

3.1 Test Setup

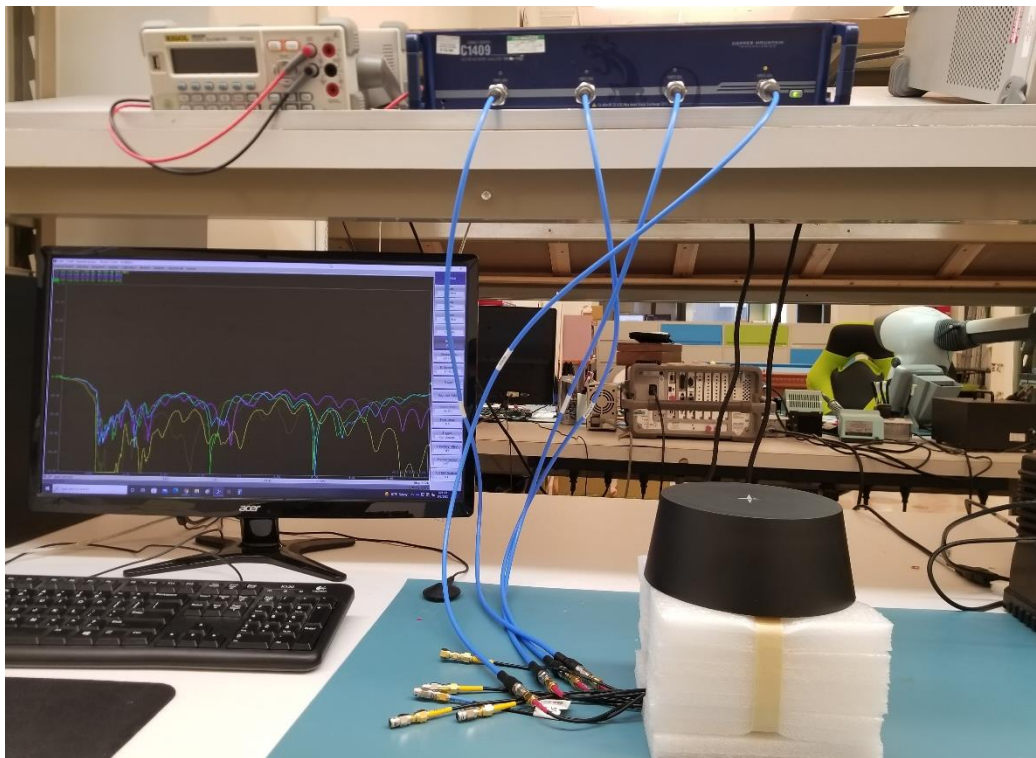
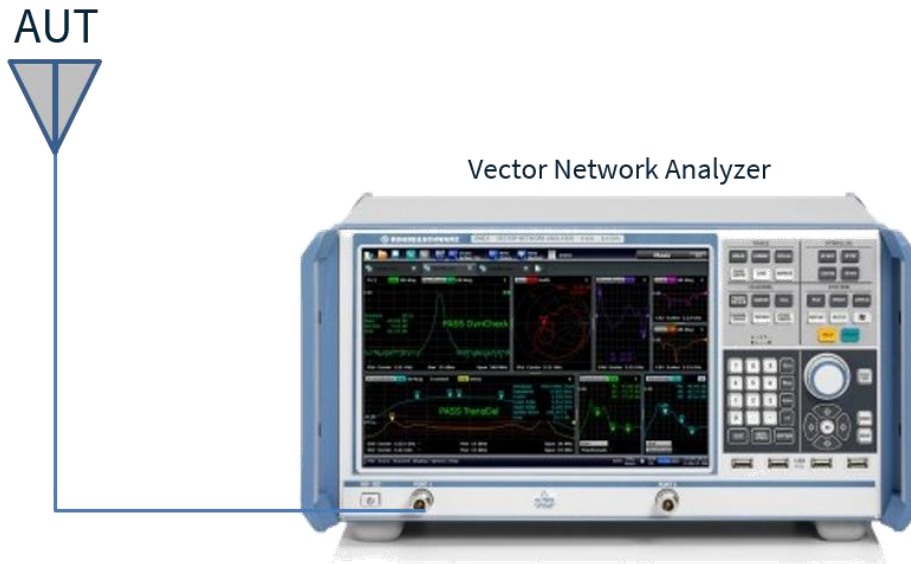

3.1 GNSS - Return Loss

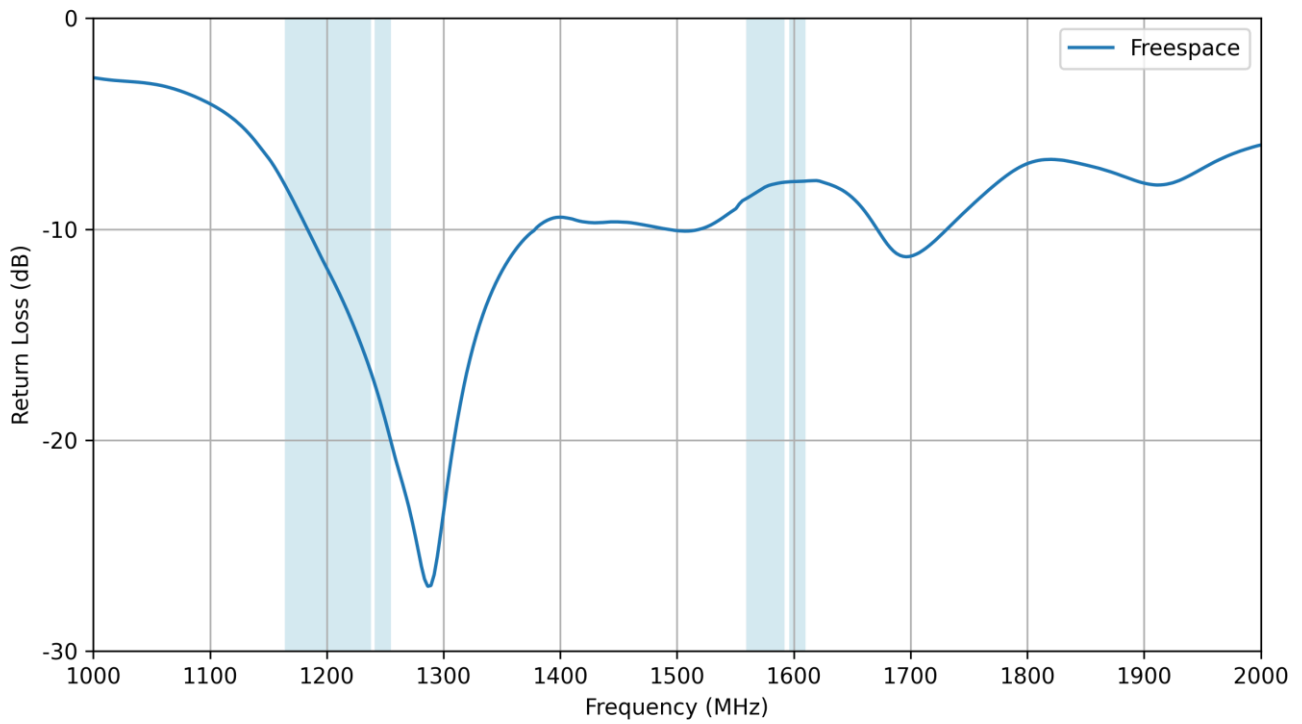

3.2 GNSS - VSWR

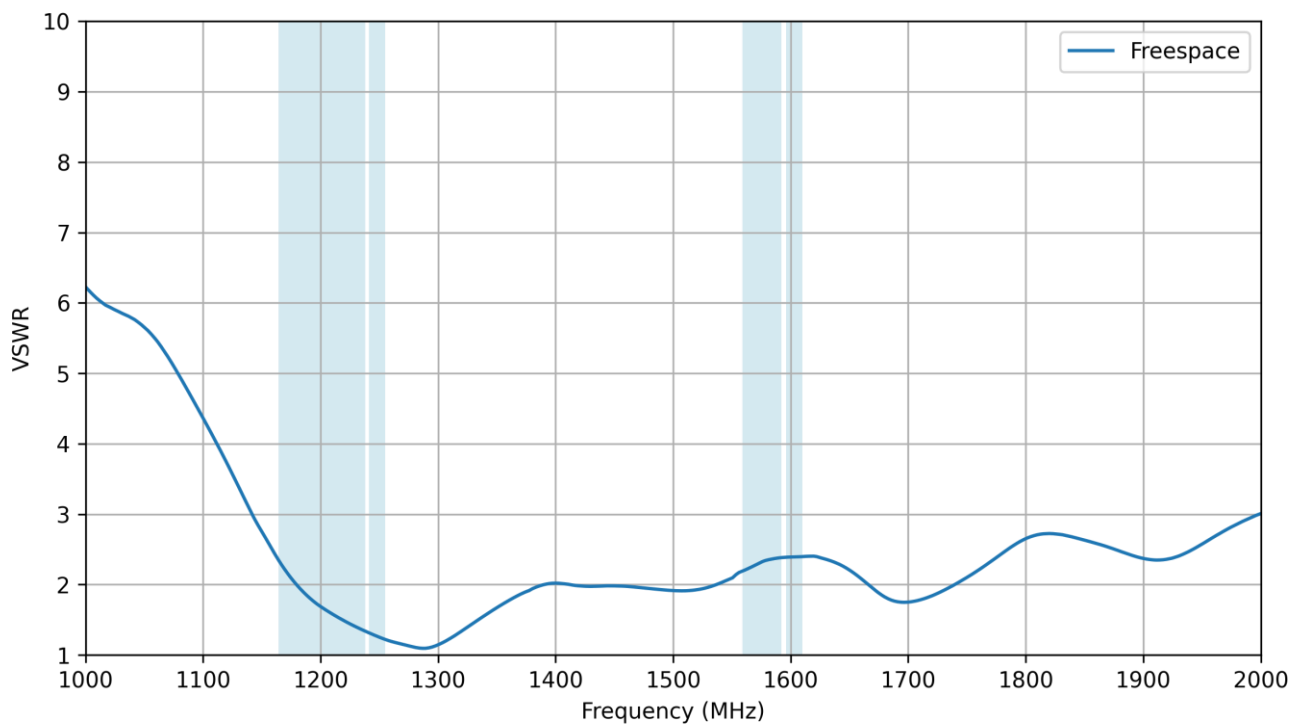

3.3 GNSS - Peak Gain

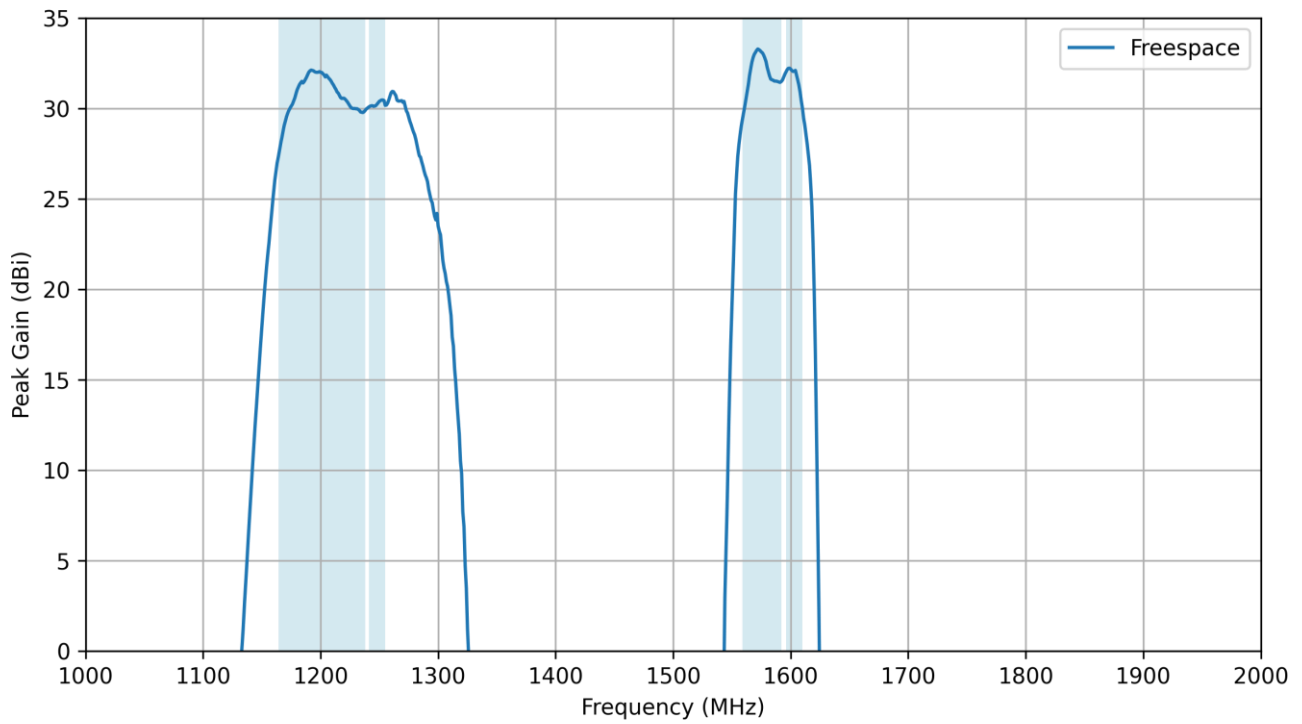

3.4 GNSS - Axial Ratio

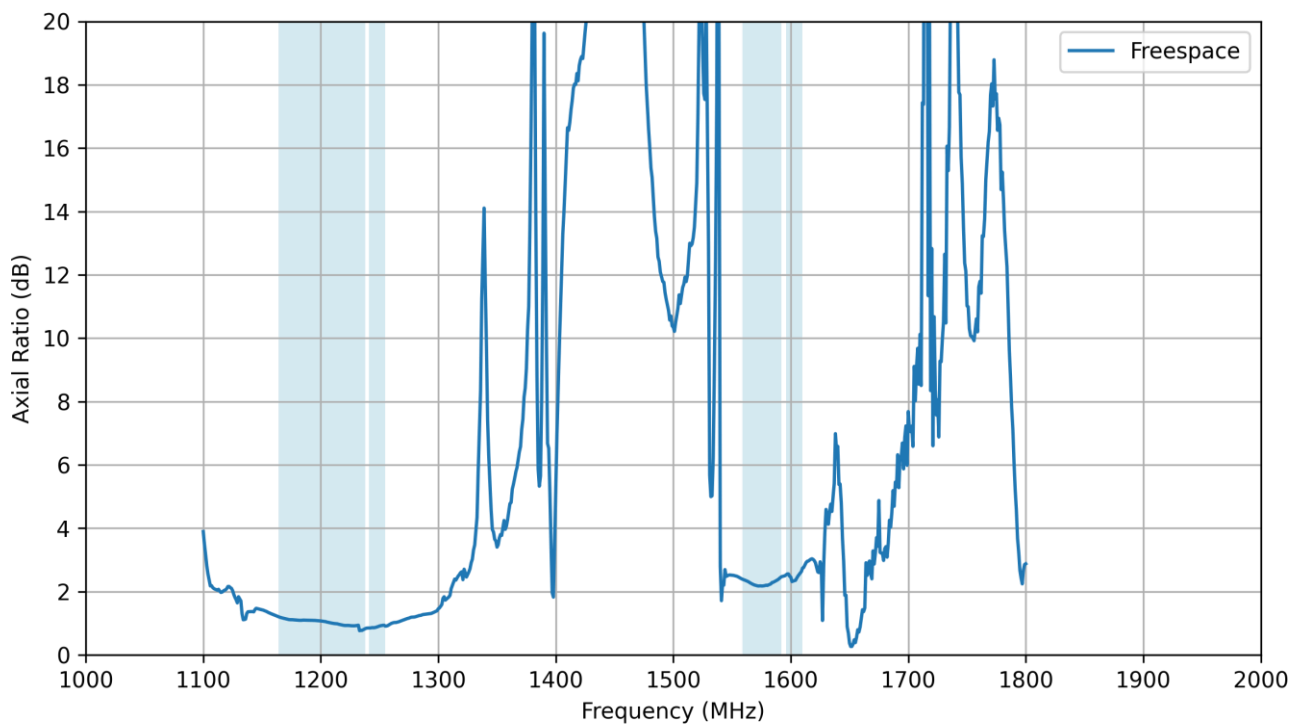

3.5 GNSS - Axial Ratio vs Angle for Phi=0

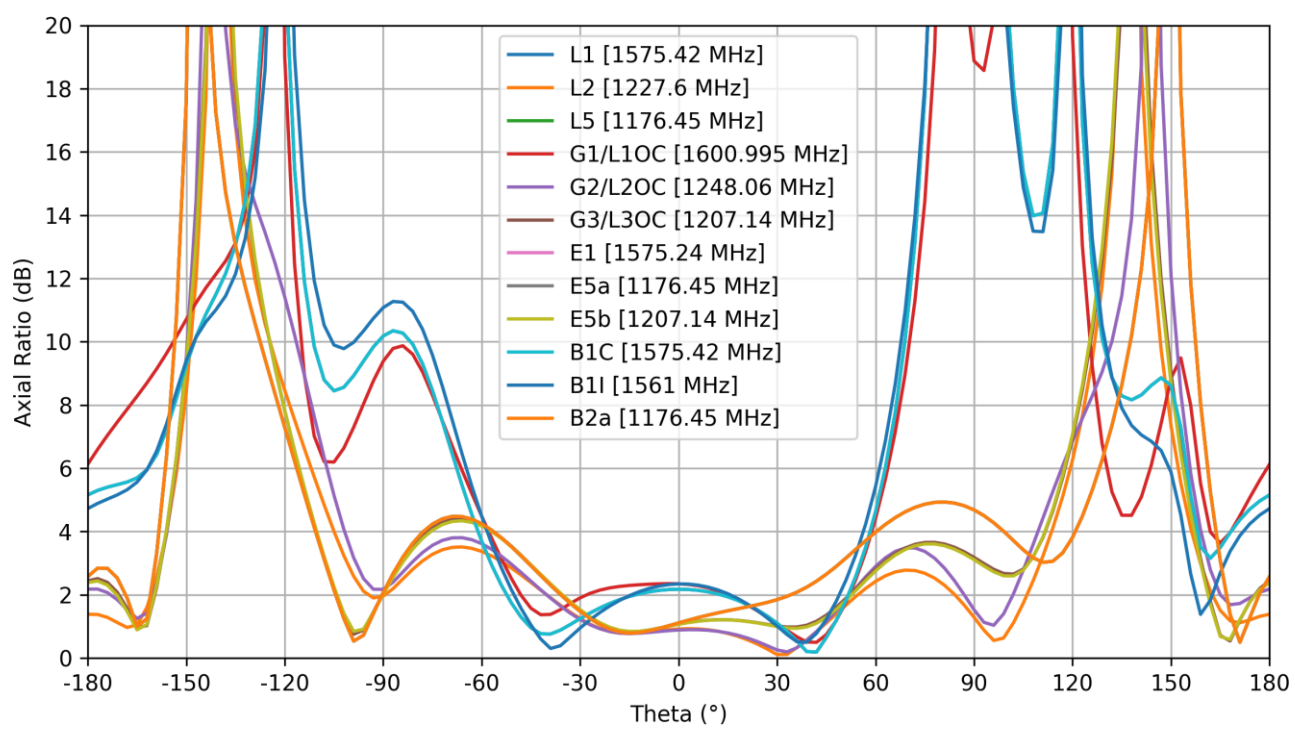

3.6 GNSS - Axial Ratio vs Angle for Phi=90

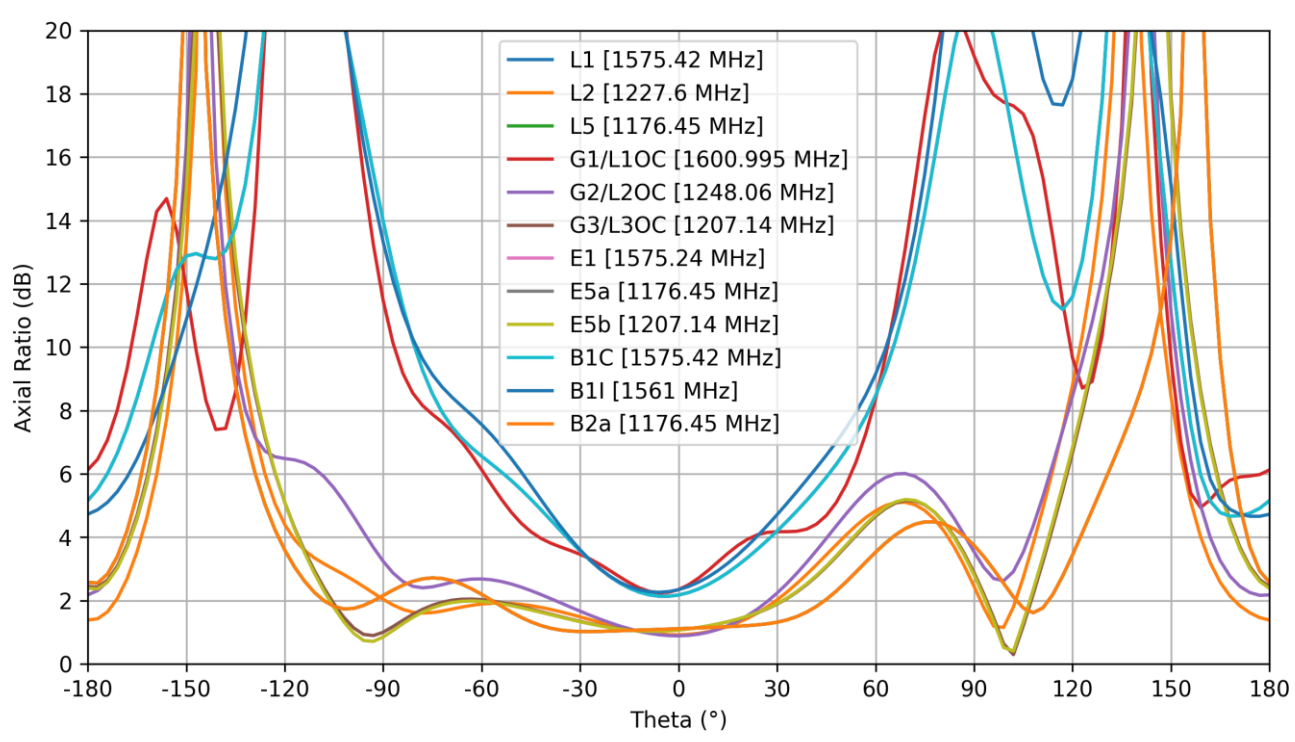

3.7 GNSS - Group Delay

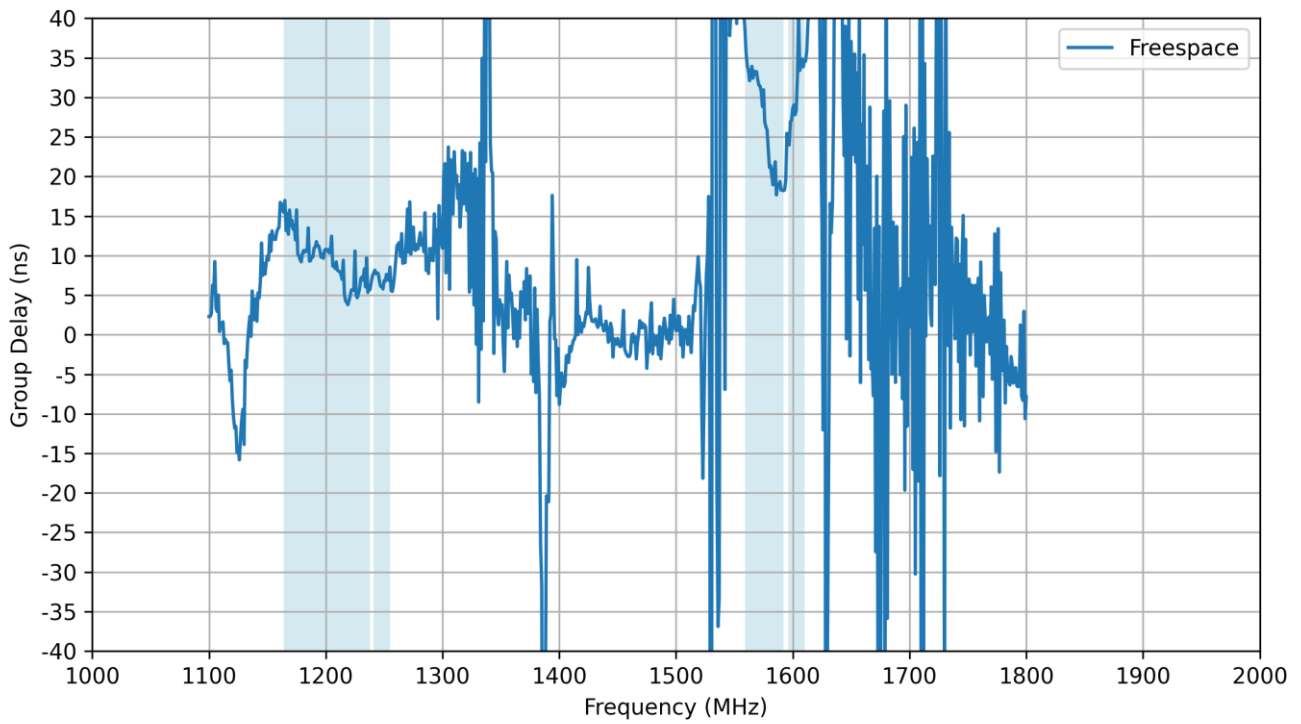

3.8 LTE - Return Loss

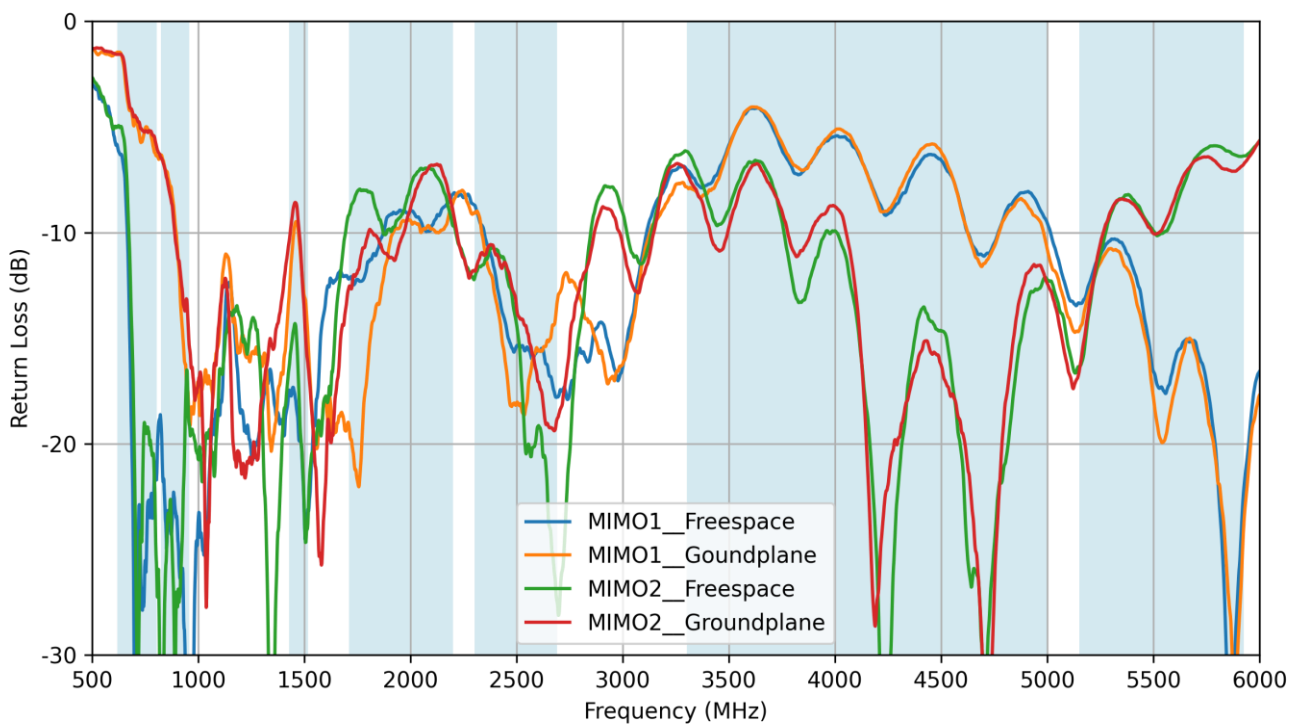

3.9 LTE - VSWR

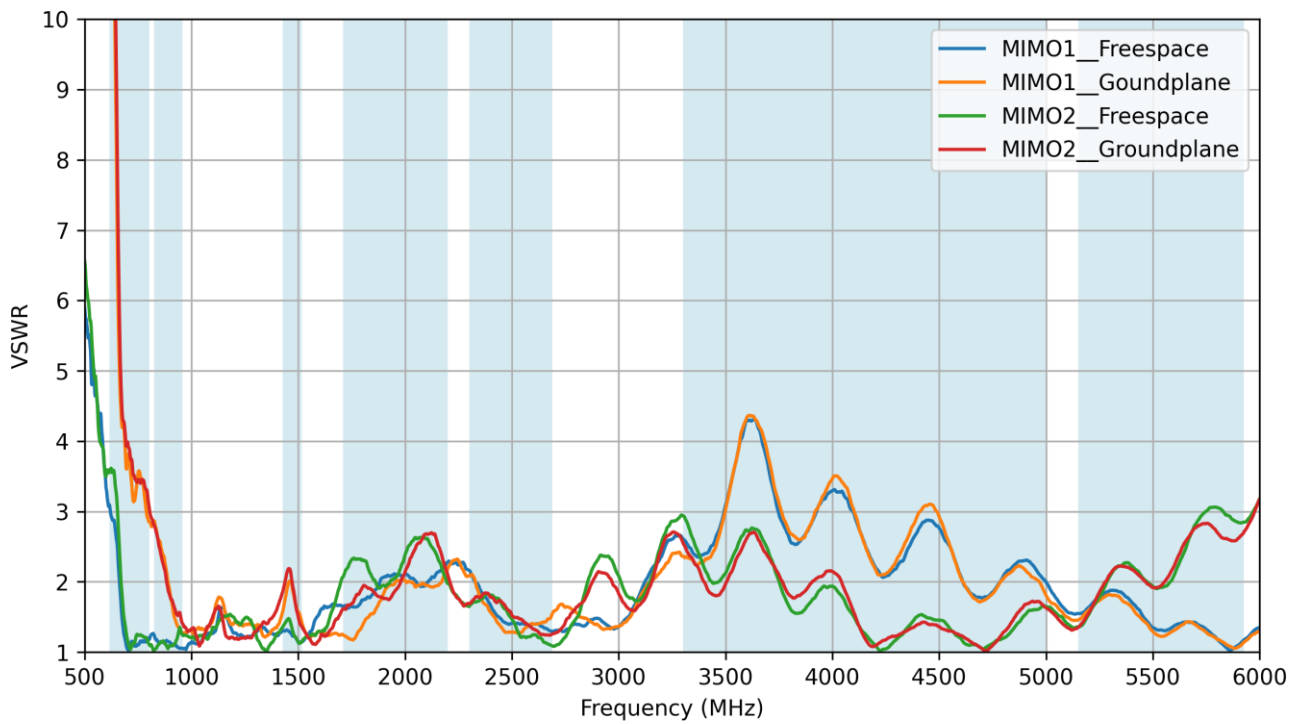

3.10 LTE - Isolation

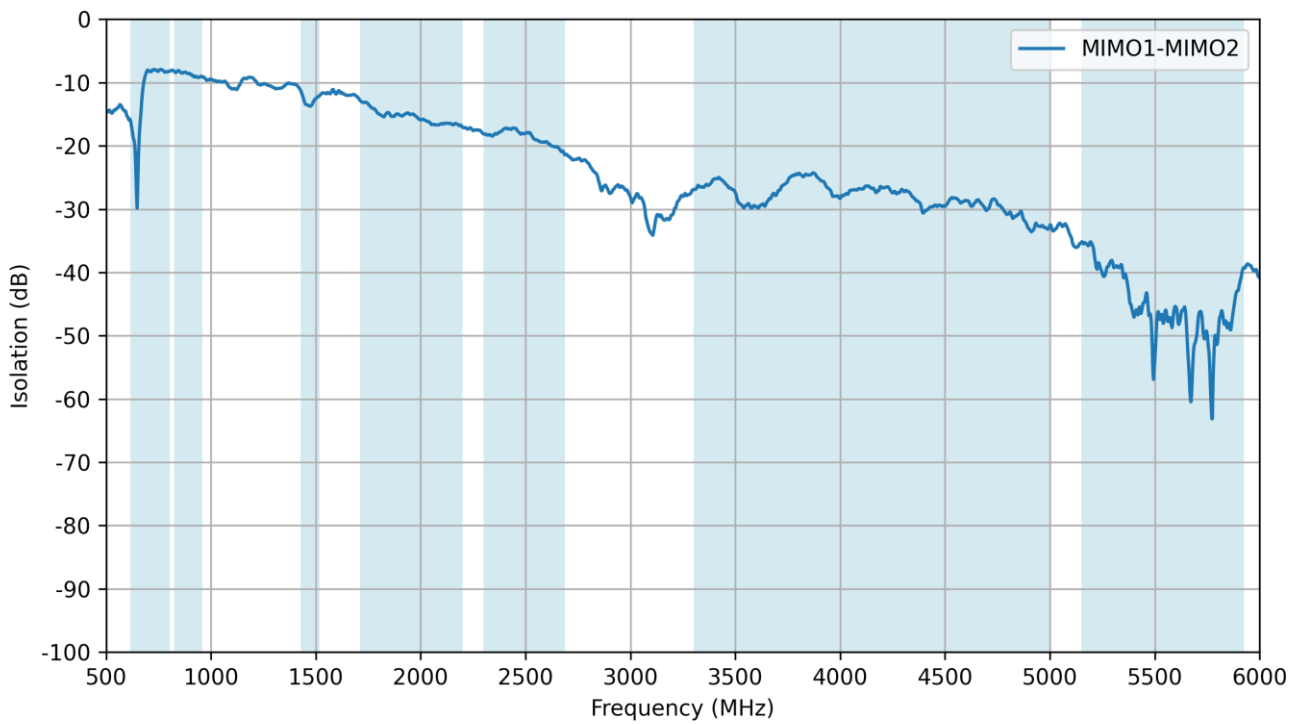

3.11 LTE - Efficiency

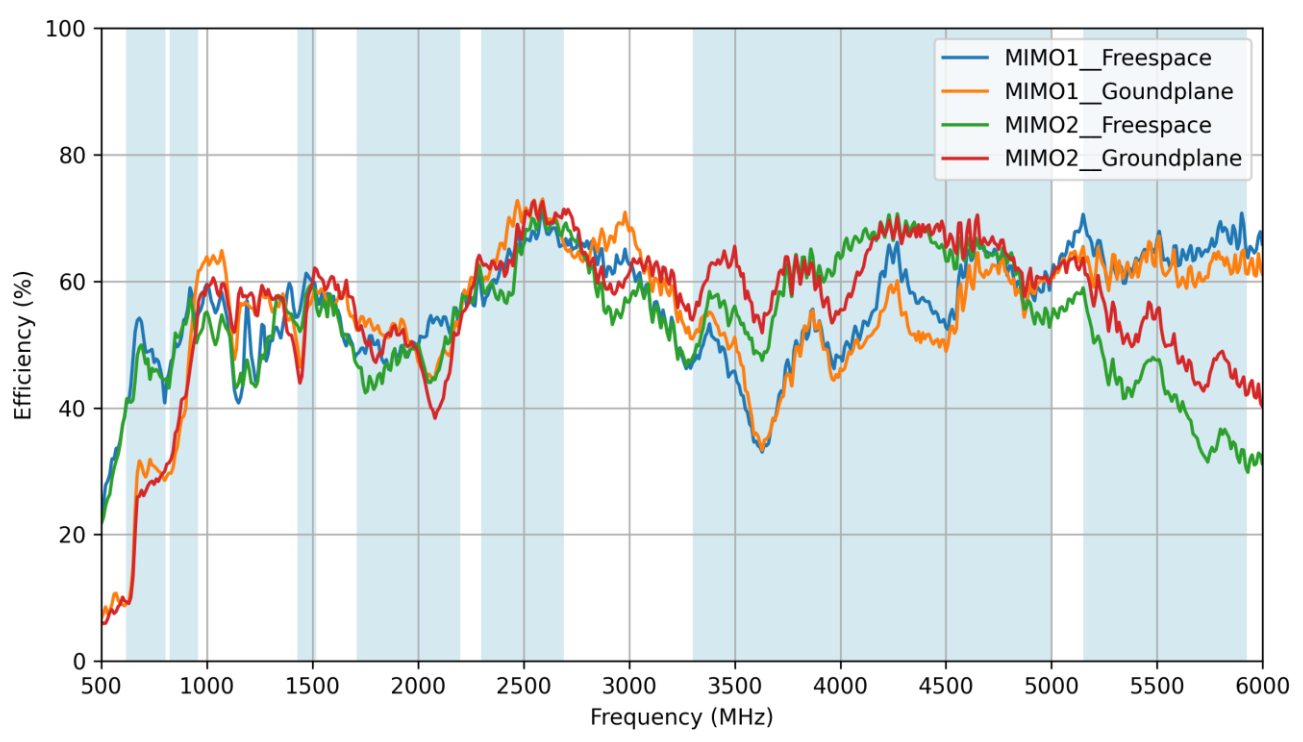

3.12 LTE - Average Gain

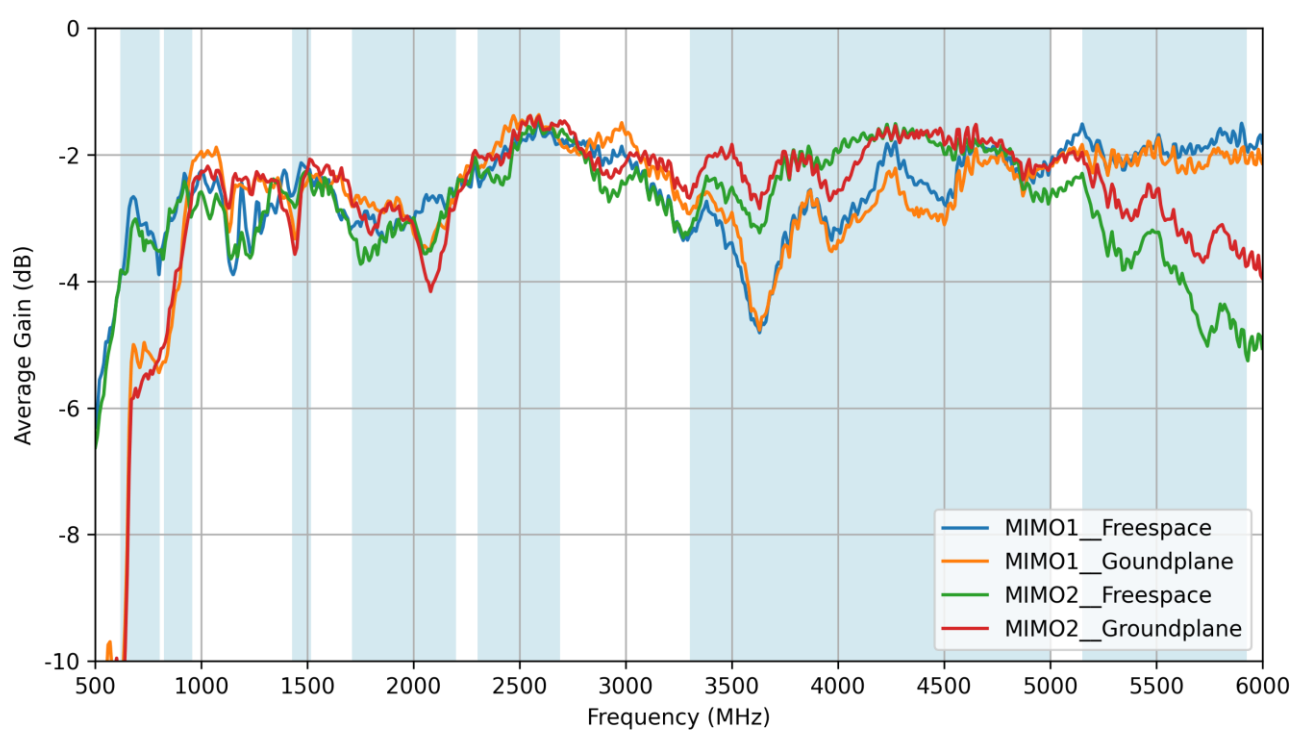

3.13 LTE - Peak Gain

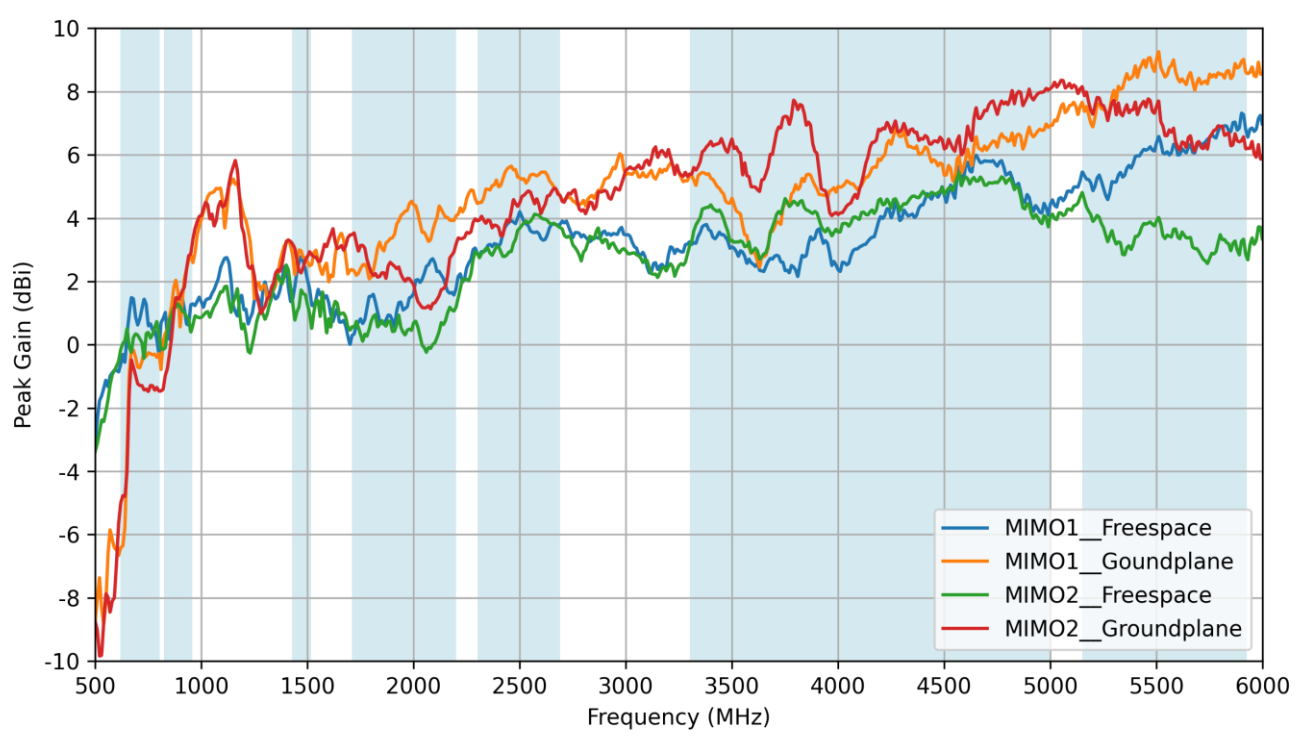

3.14 Wi-Fi - Return Loss

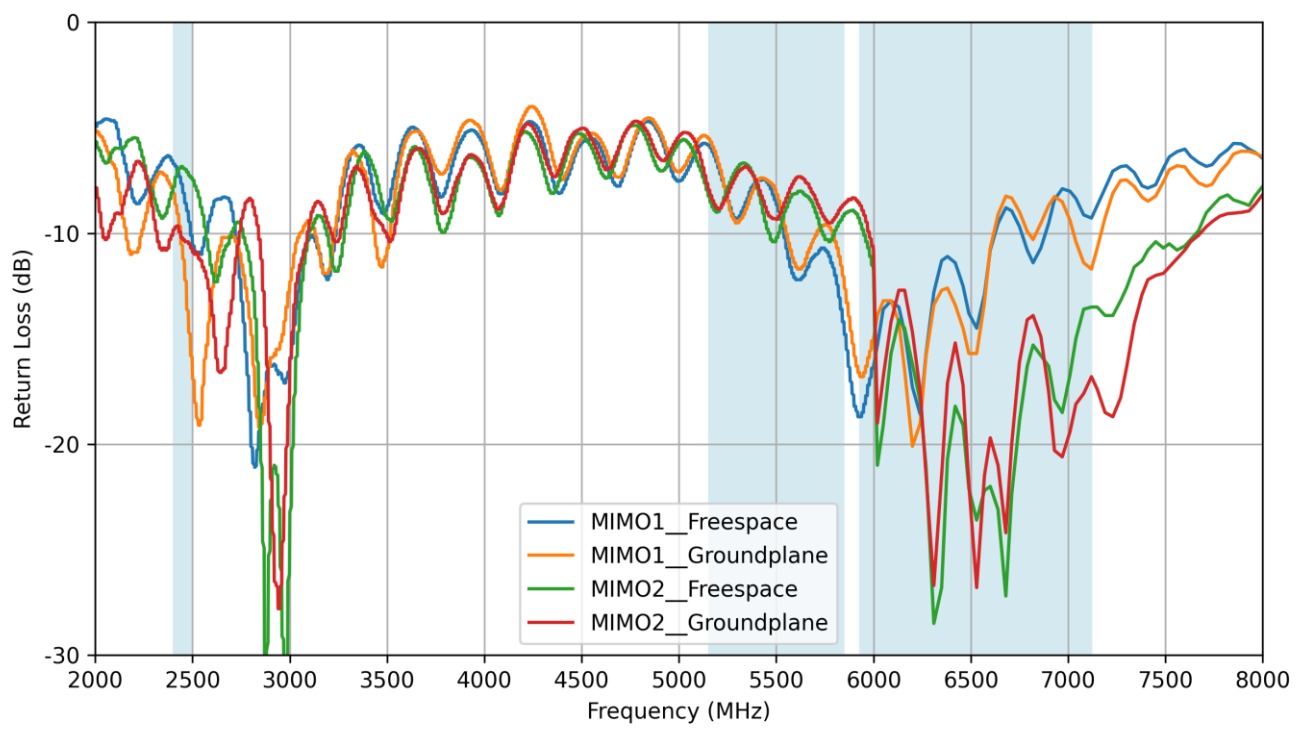

3.15 Wi-Fi - VSWR

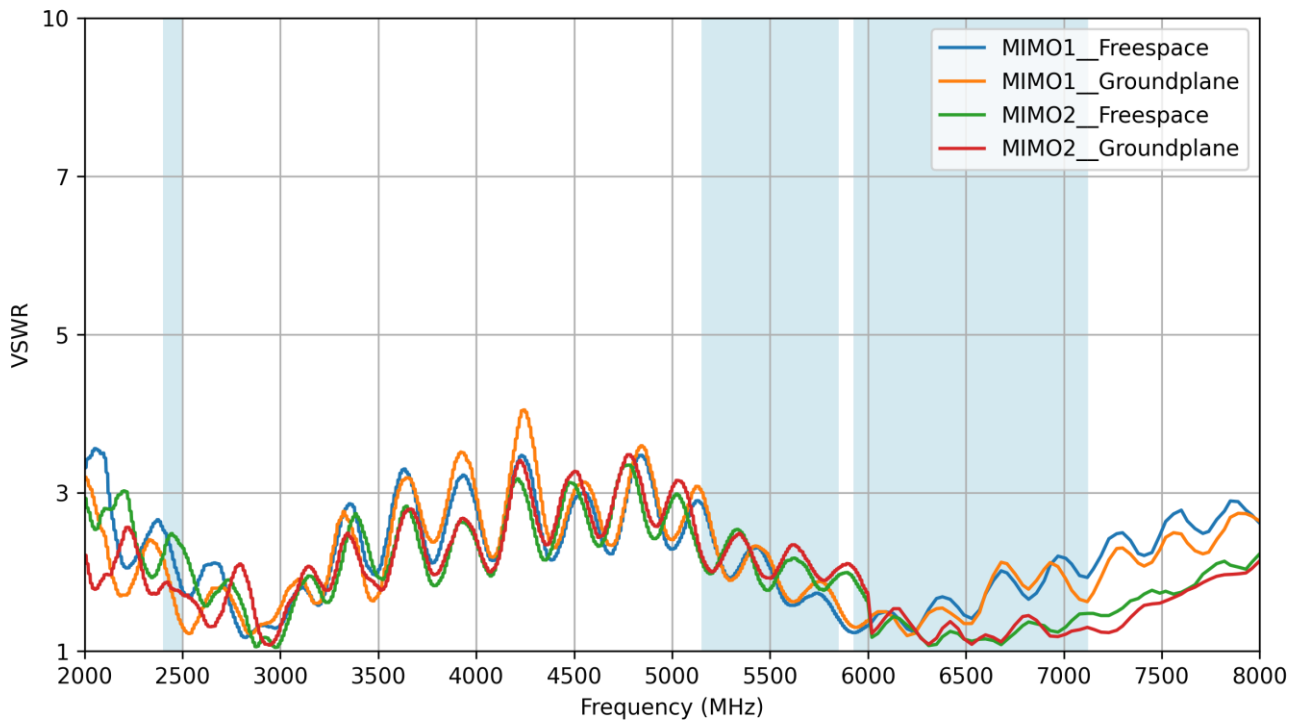

3.16 Wi-Fi - Isolation

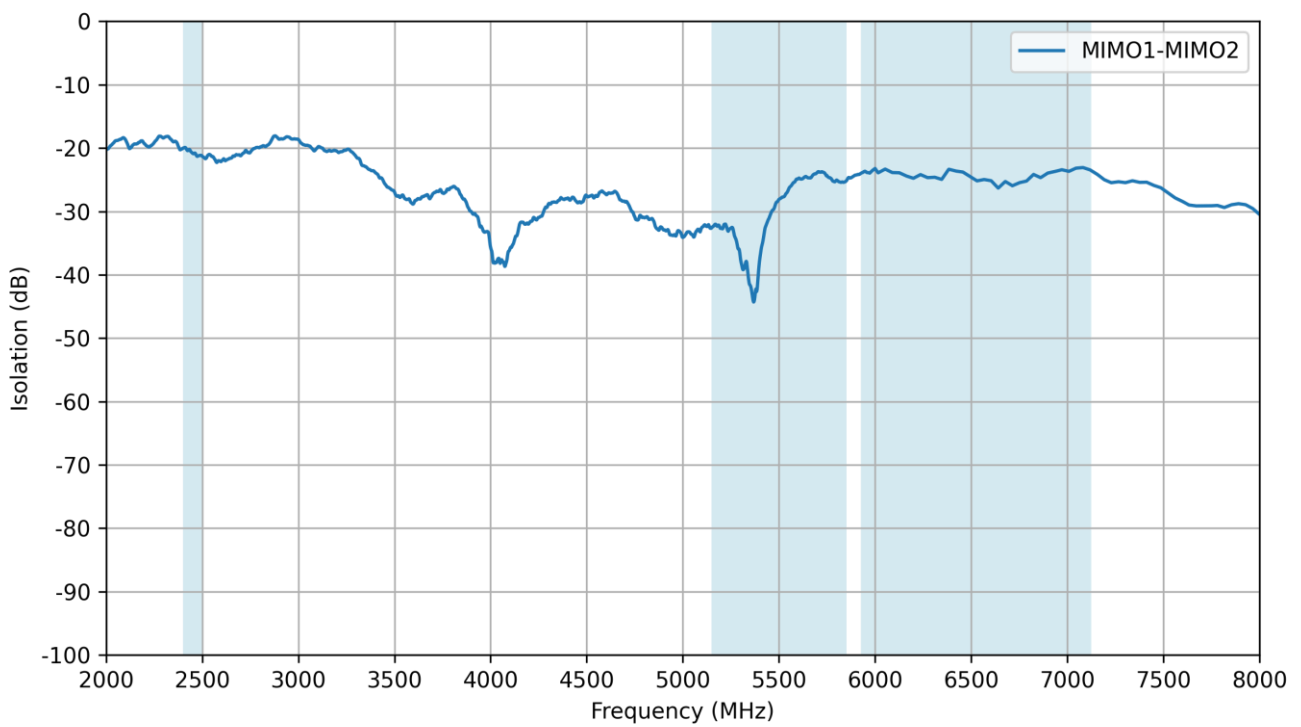

3.17 Wi-Fi - Efficiency

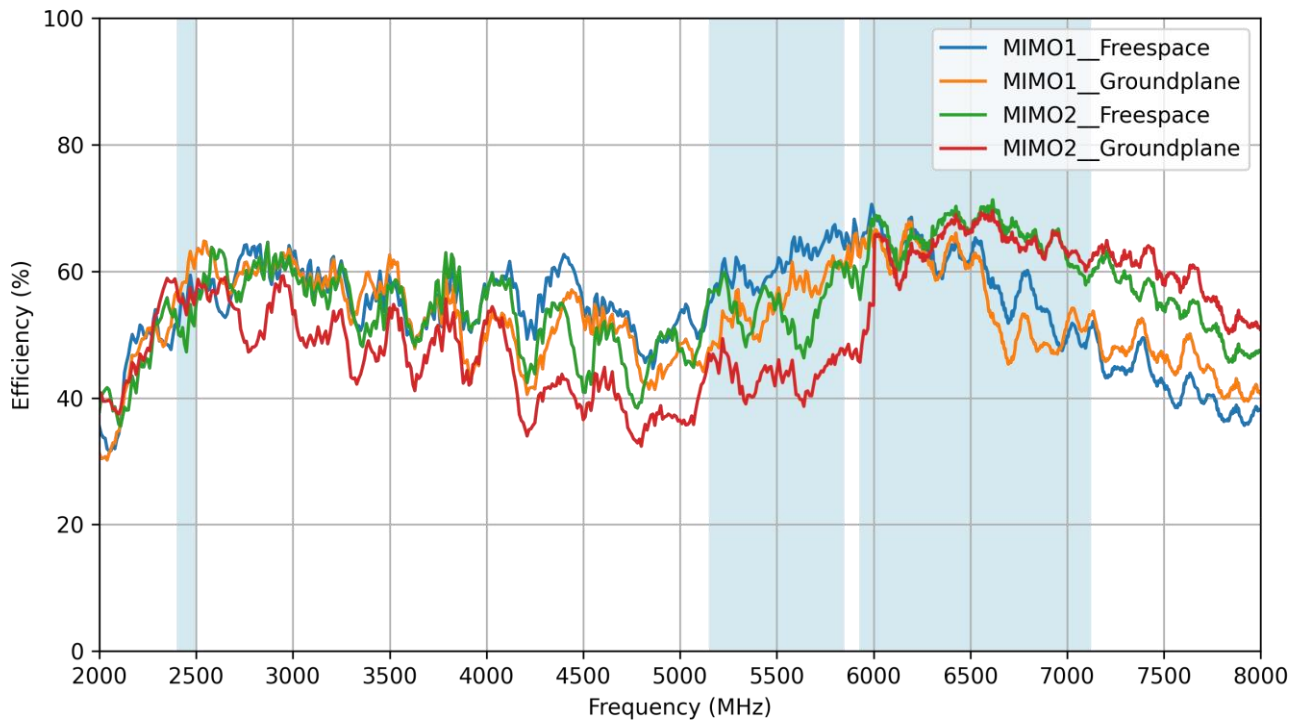

3.18 Wi-Fi - Average Gain

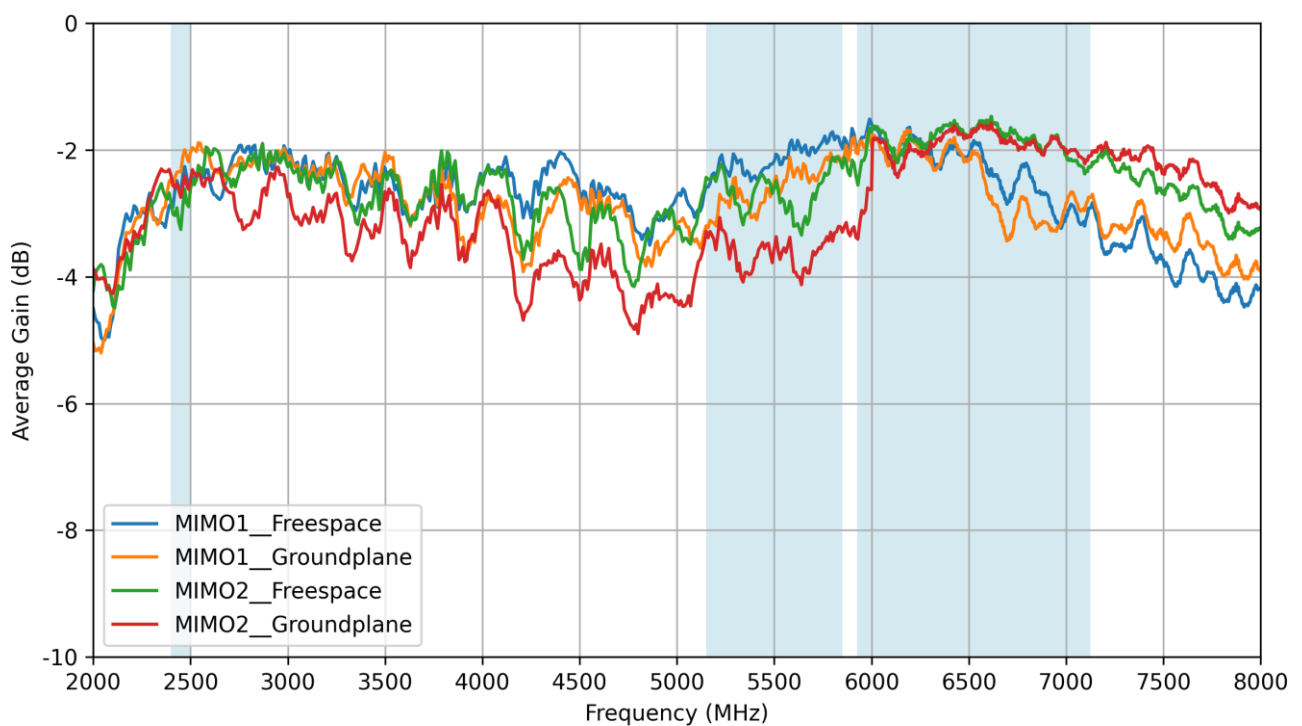

3.19 Wi-Fi - Peak Gain

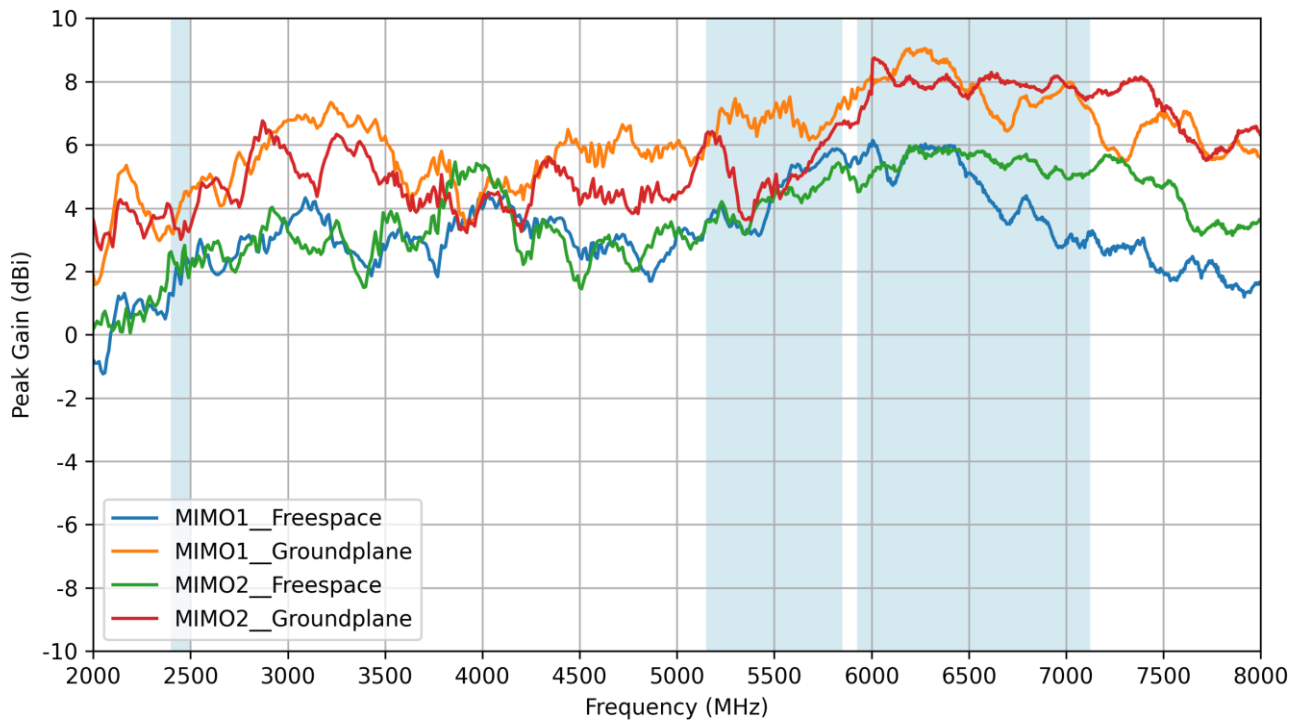

4. Radiation Patterns

4.1 Test Setup

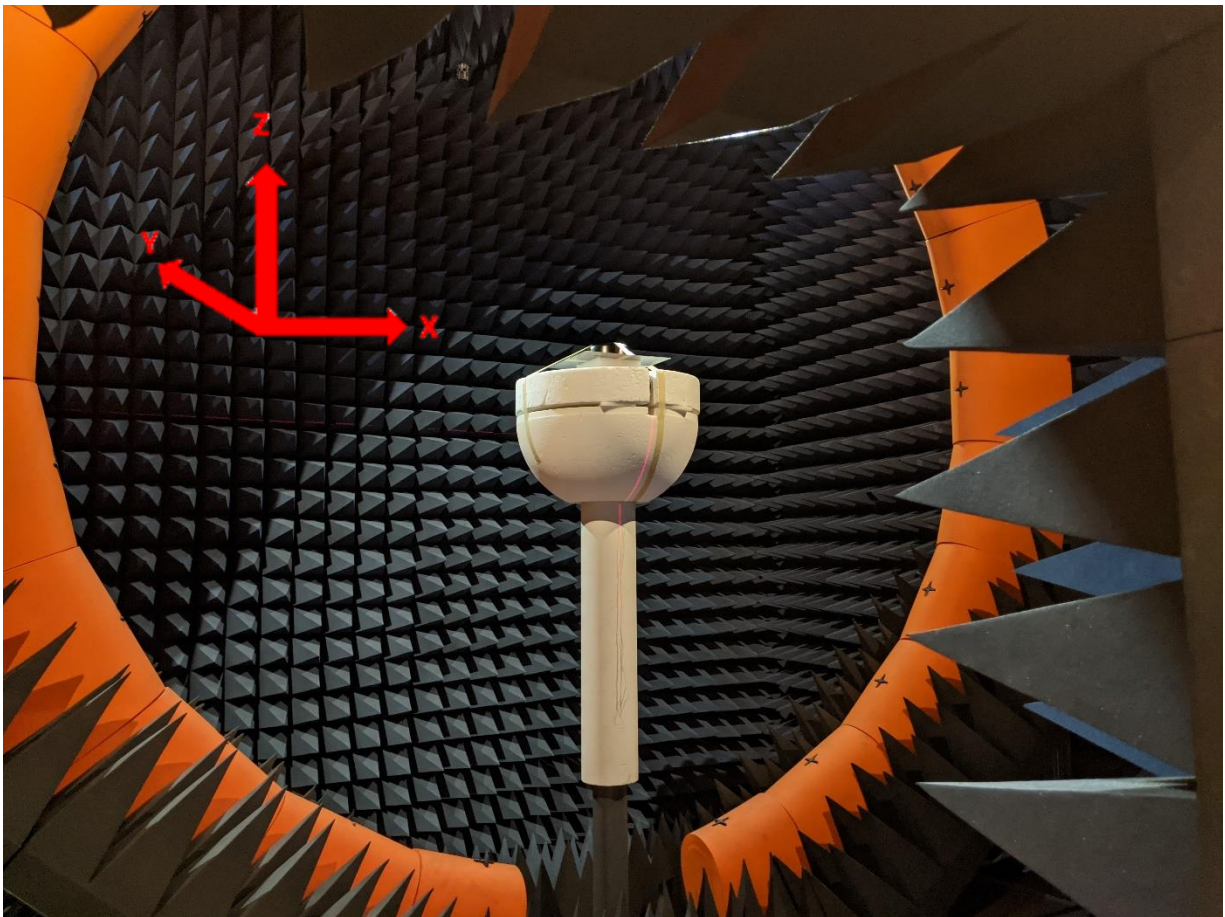
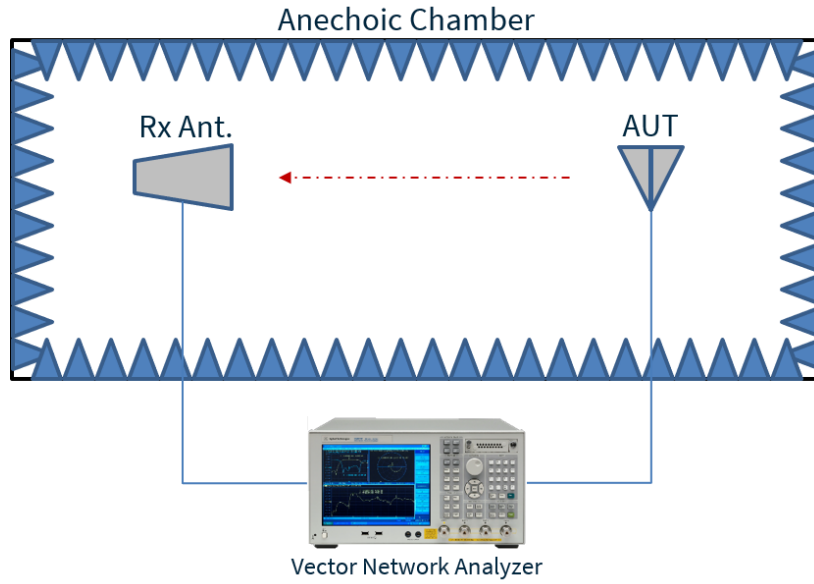

4.1 GNSS Free Space Patterns at 1576 MHz

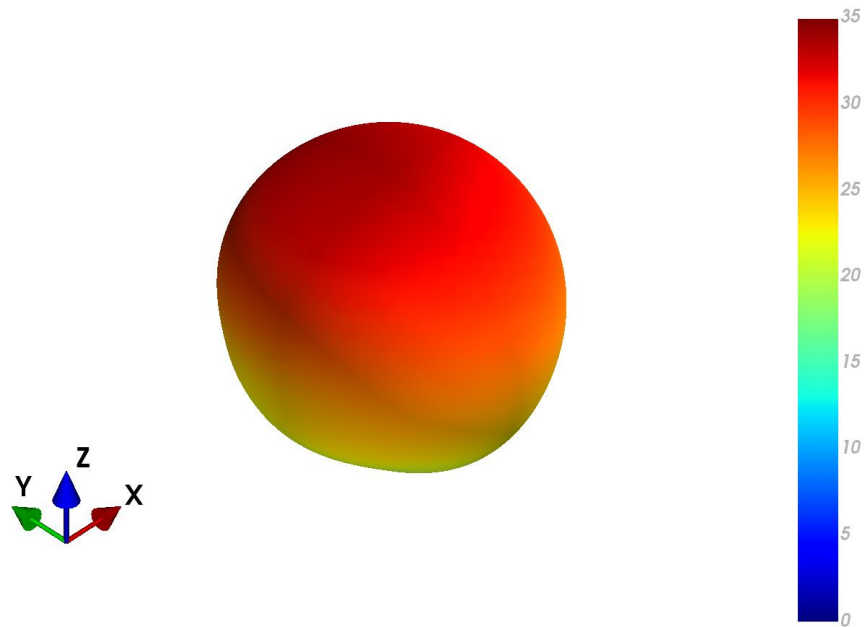

XZ Plane YZ Plane XY Plane

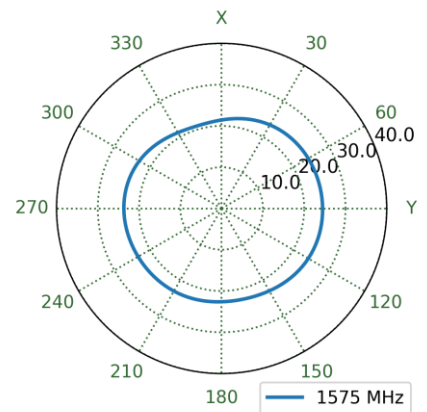
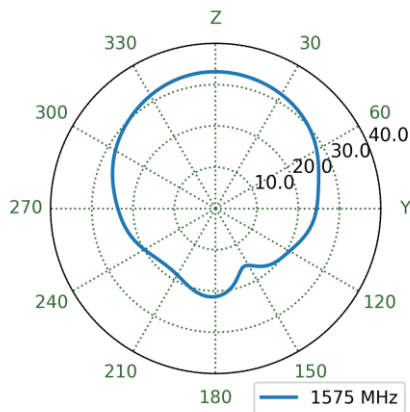
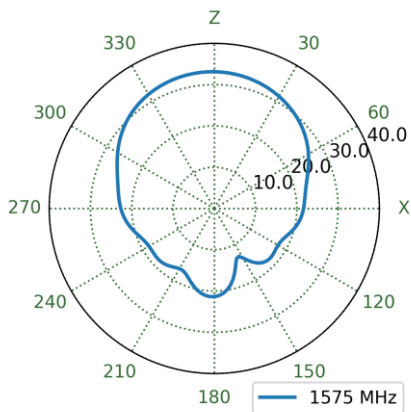

4.2 GNSS Free Space Patterns at 1228 MHz

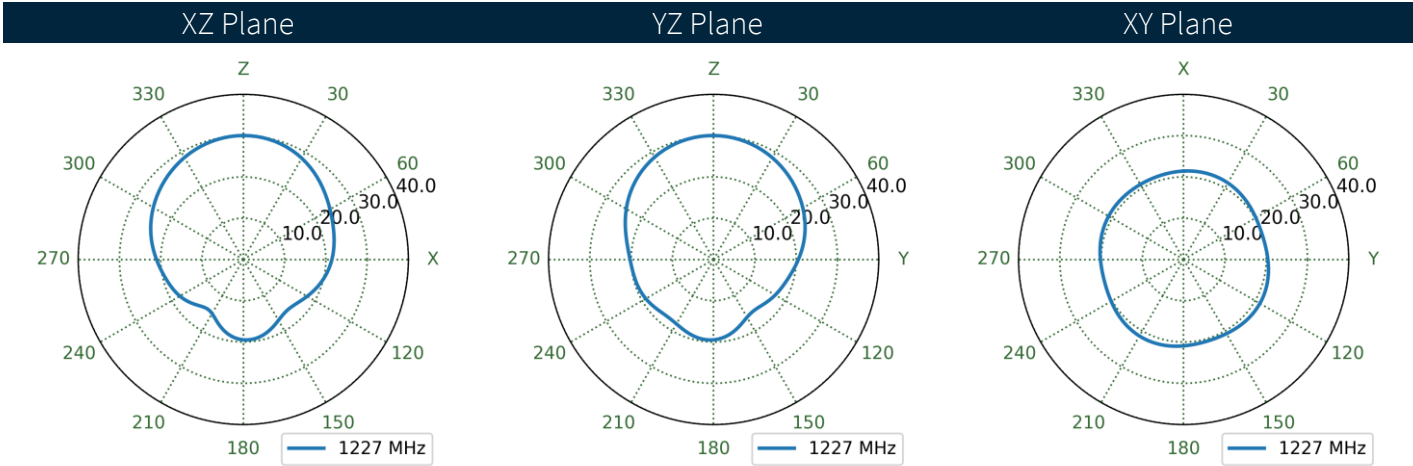
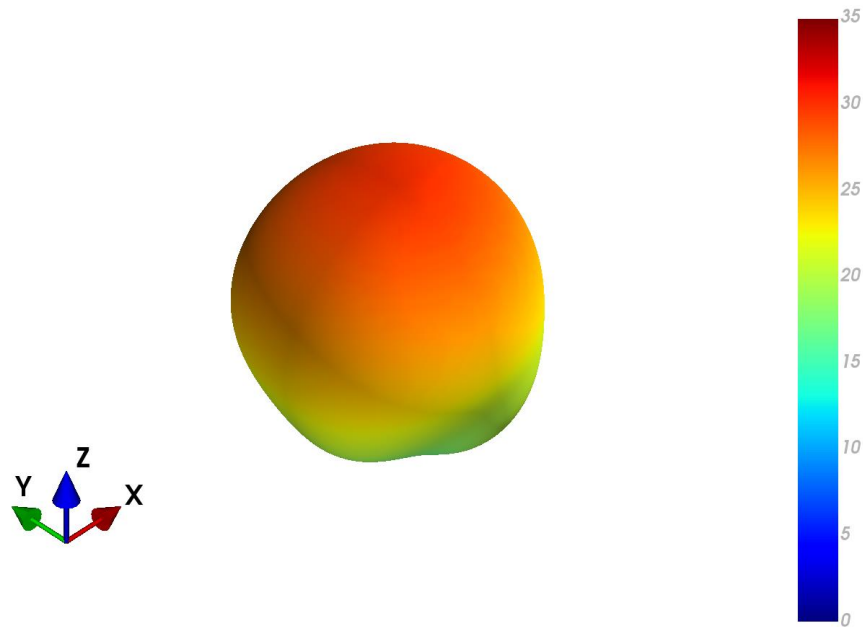

4.3 GNSS Free Space Patterns at 1177 MHz

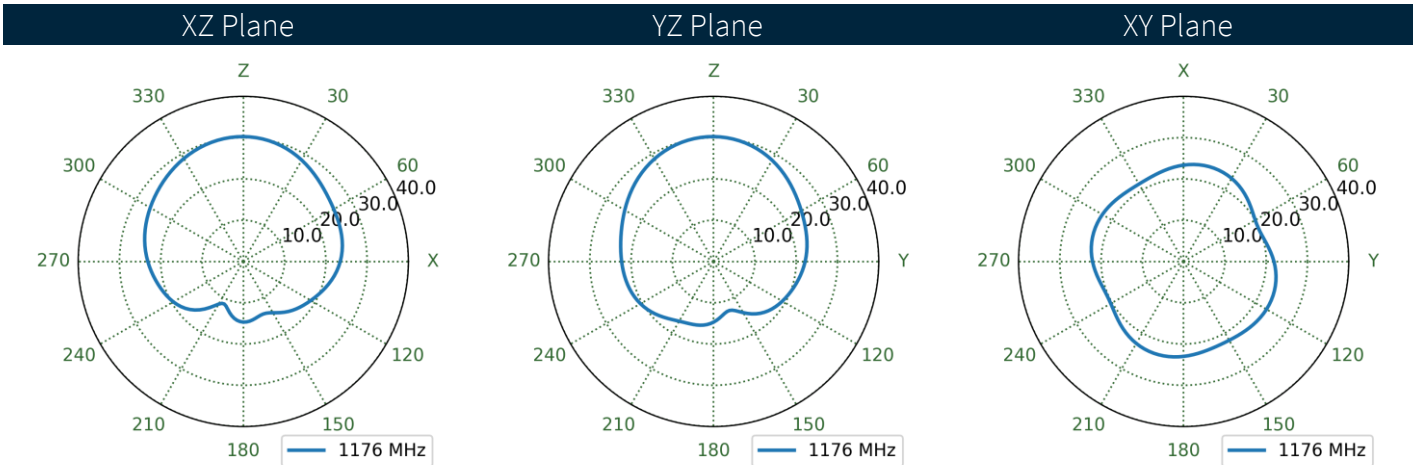
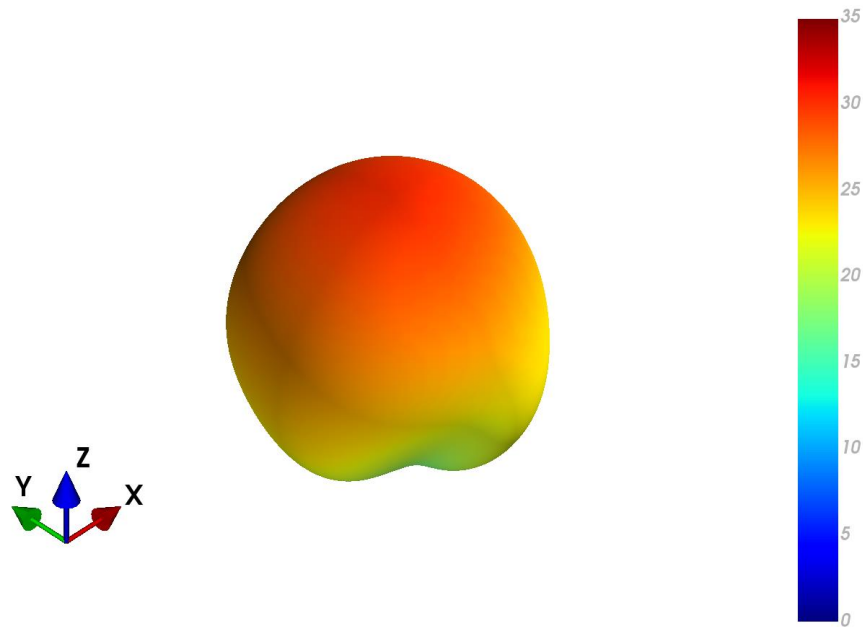

4.4 GNSS Free Space Patterns at 1603 MHz

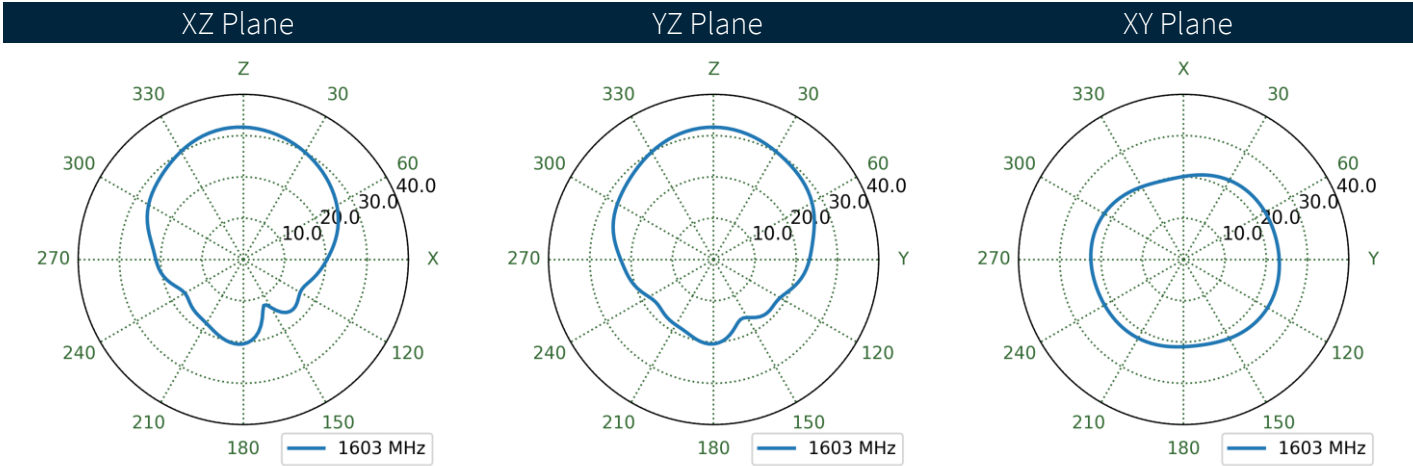
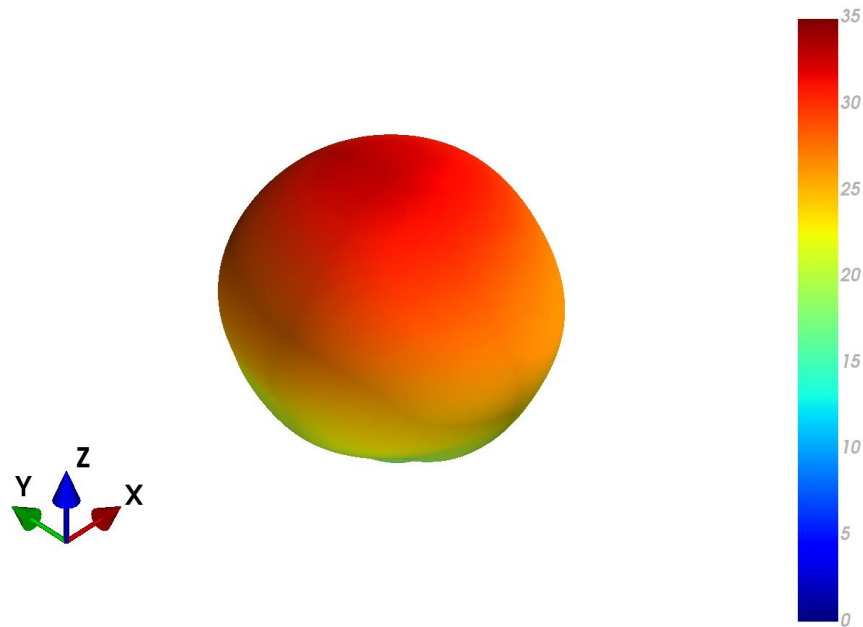

4.5 GNSS Free Space Patterns at 1248 MHz

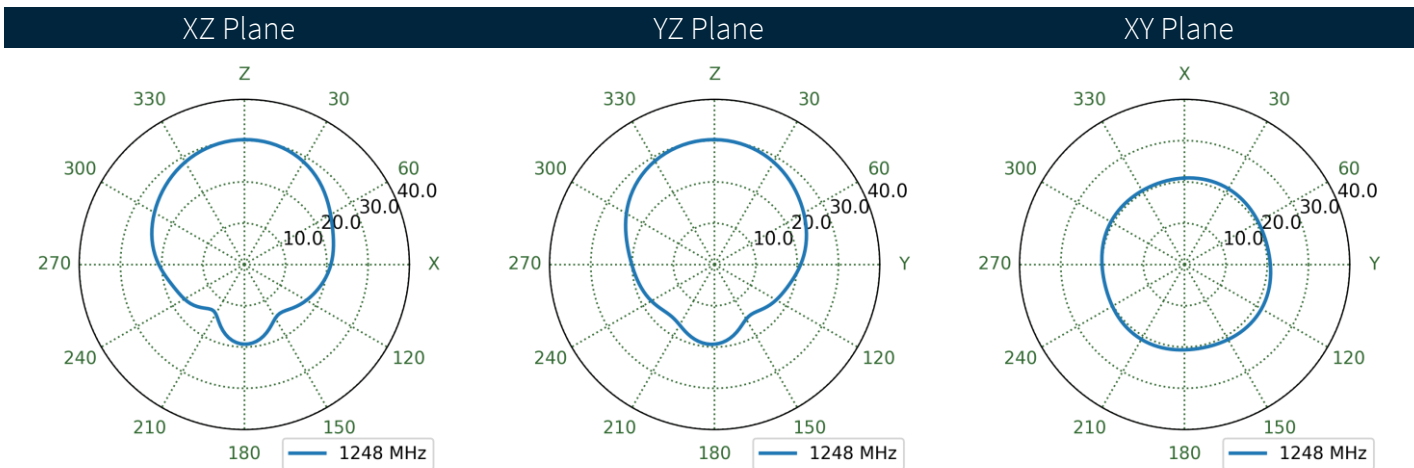
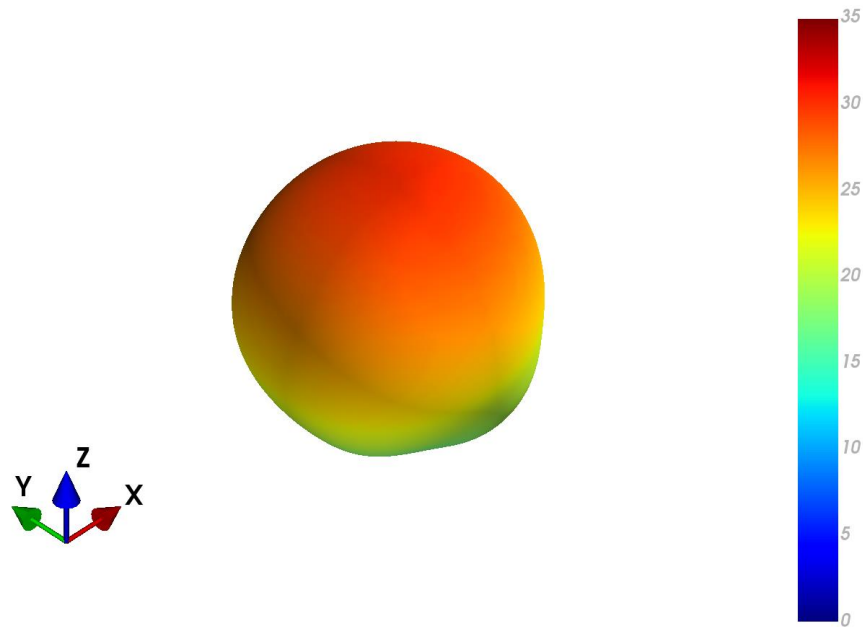

4.6 GNSS Free Space Patterns at 1201 MHz

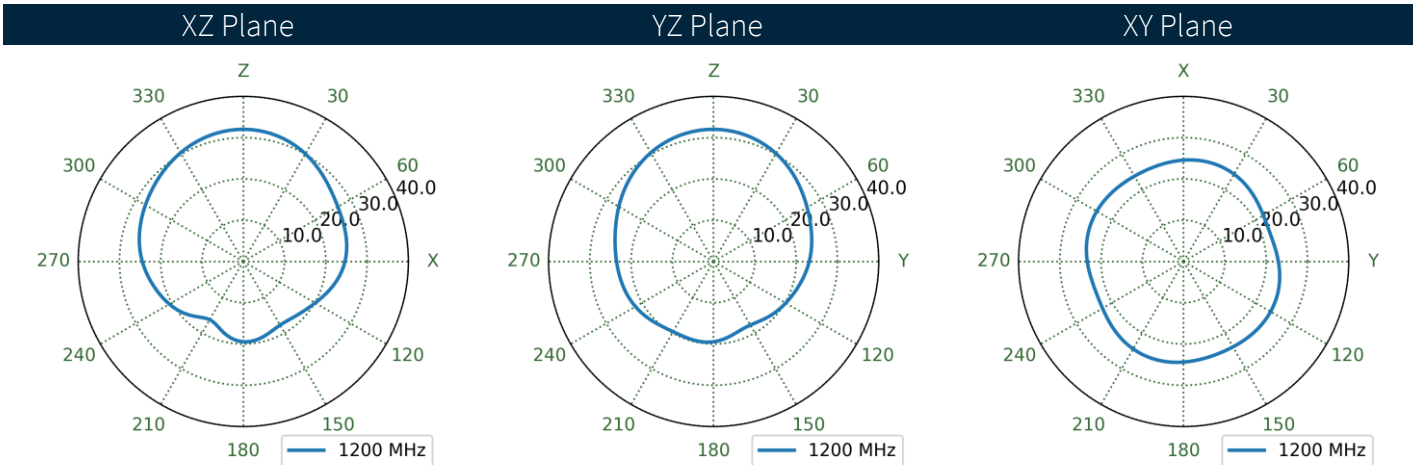
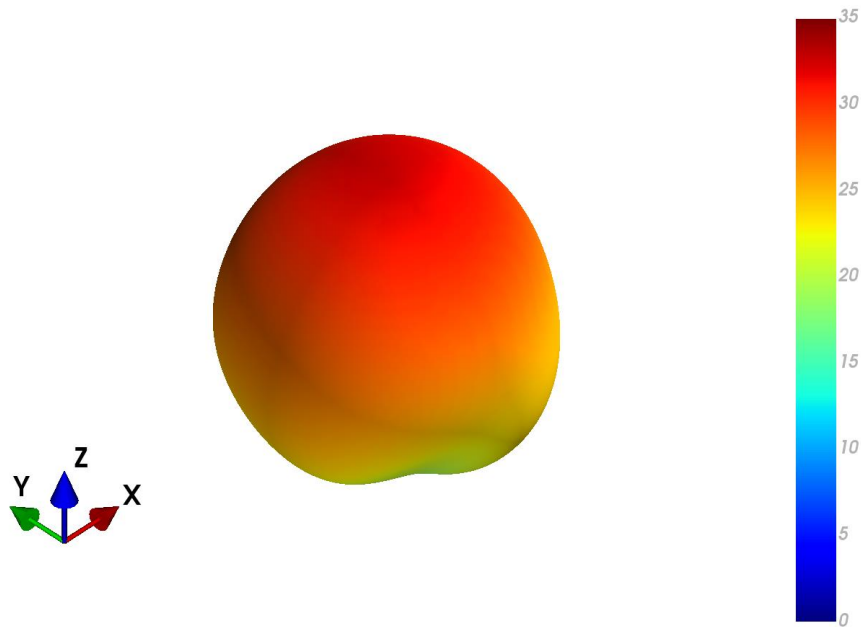

4.7 GNSS Free Space Patterns at 1576 MHz

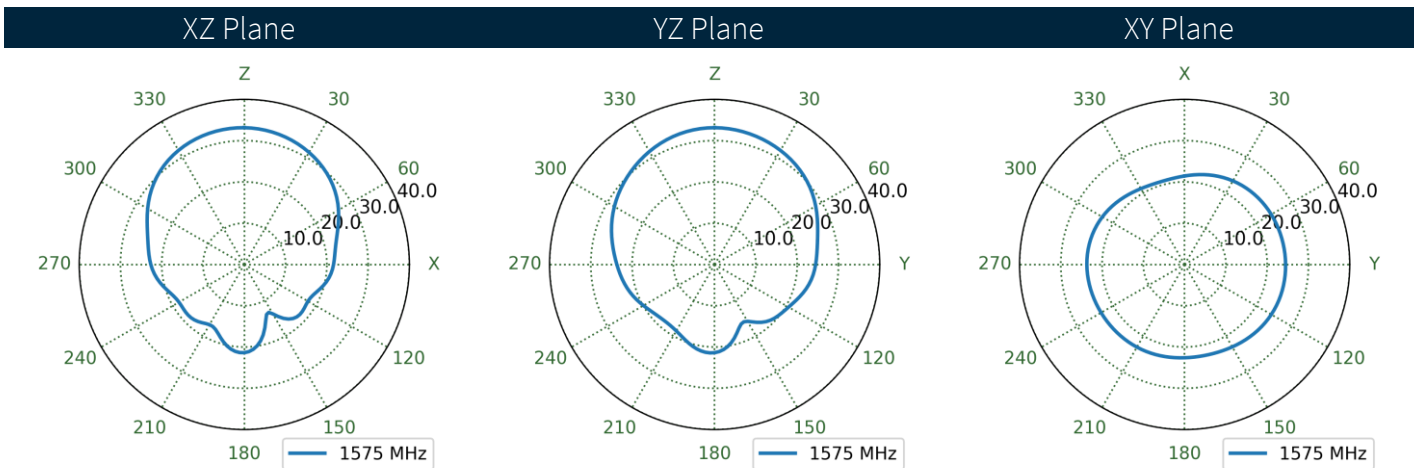
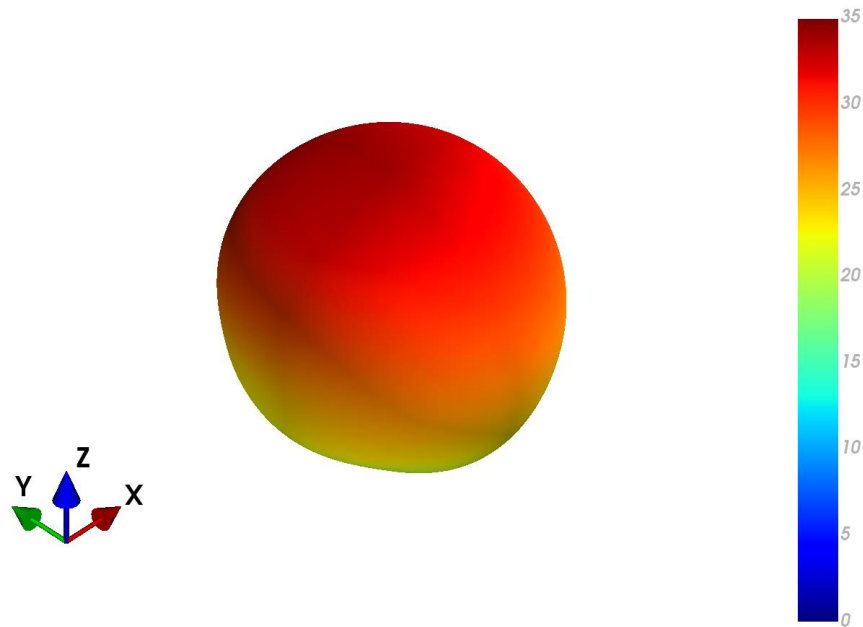

4.8 GNSS Free Space Patterns at 1176 MHz

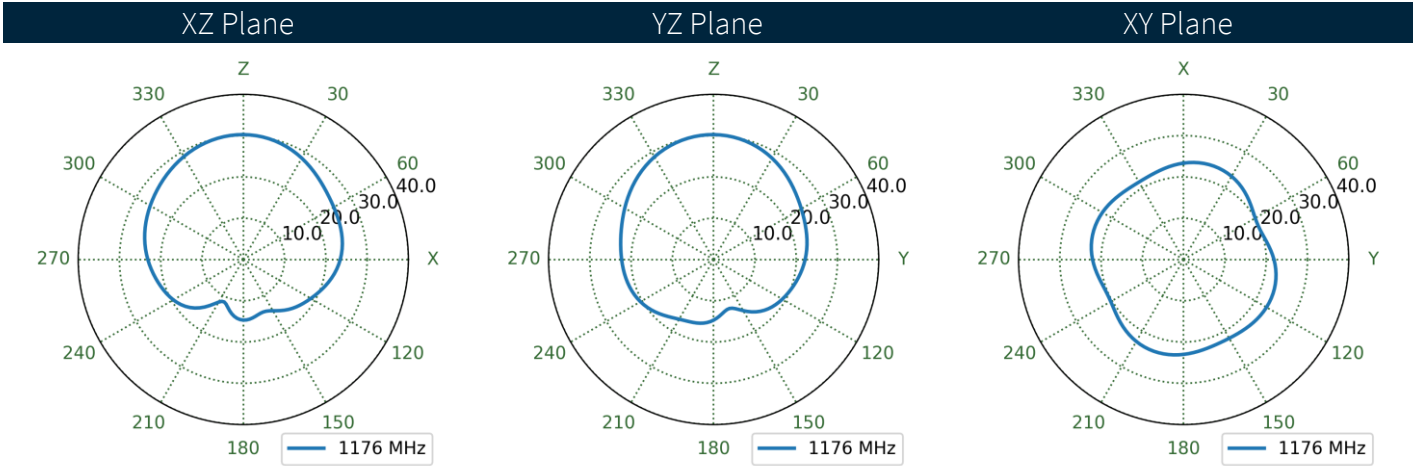
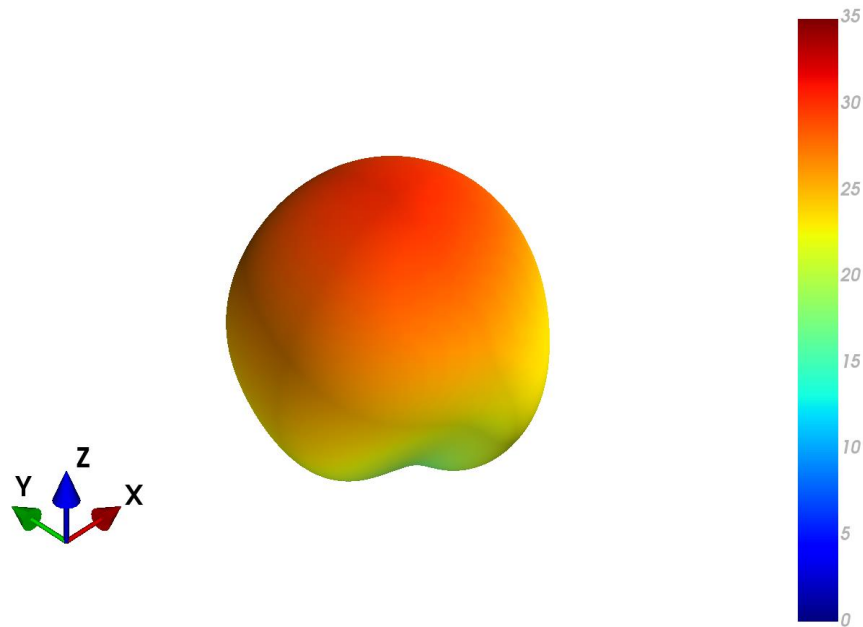

4.9 GNSS Free Space Patterns at 1202 MHz

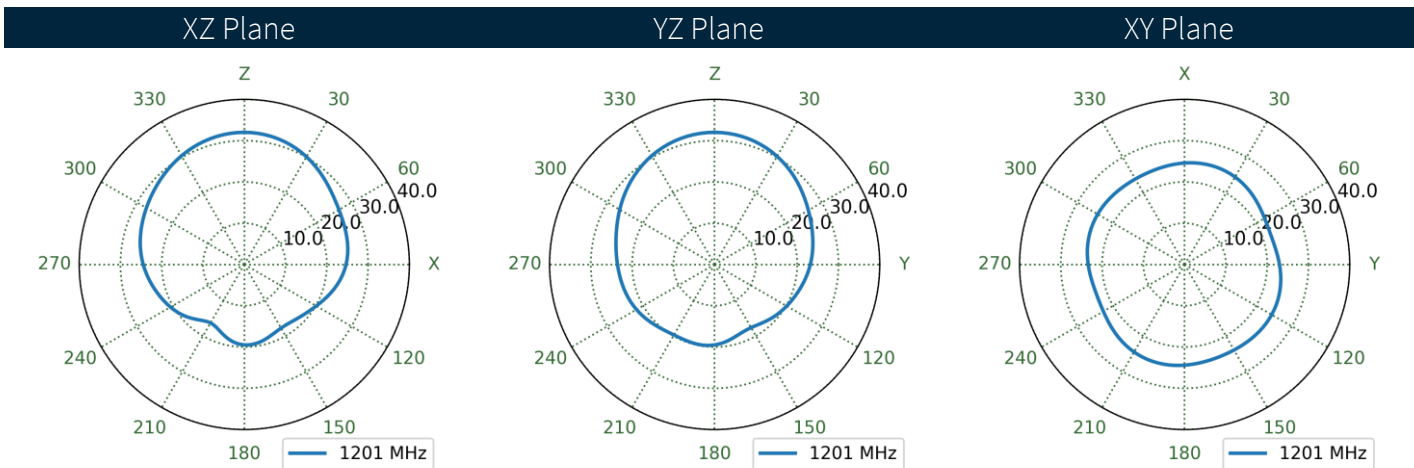
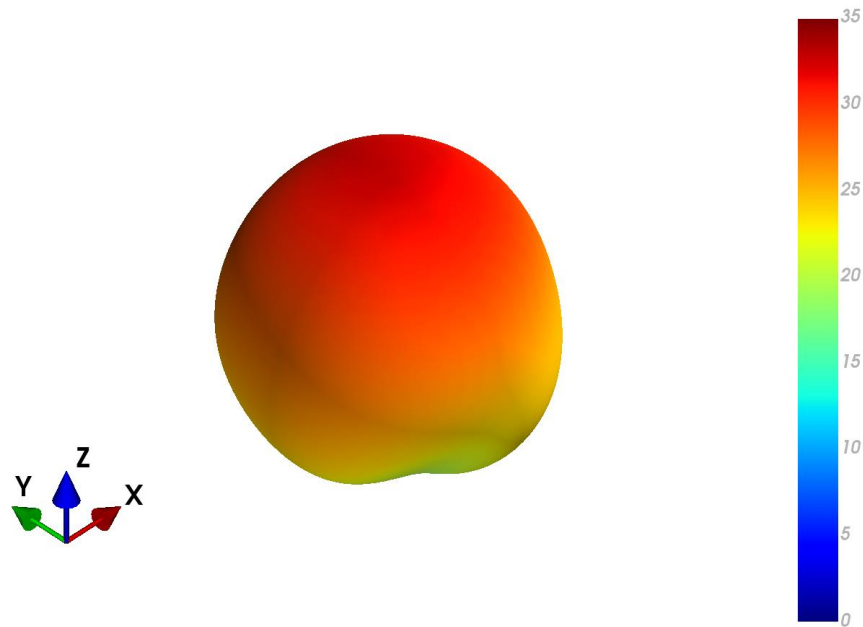

4.10 GNSS Free Space Patterns at 1576 MHz

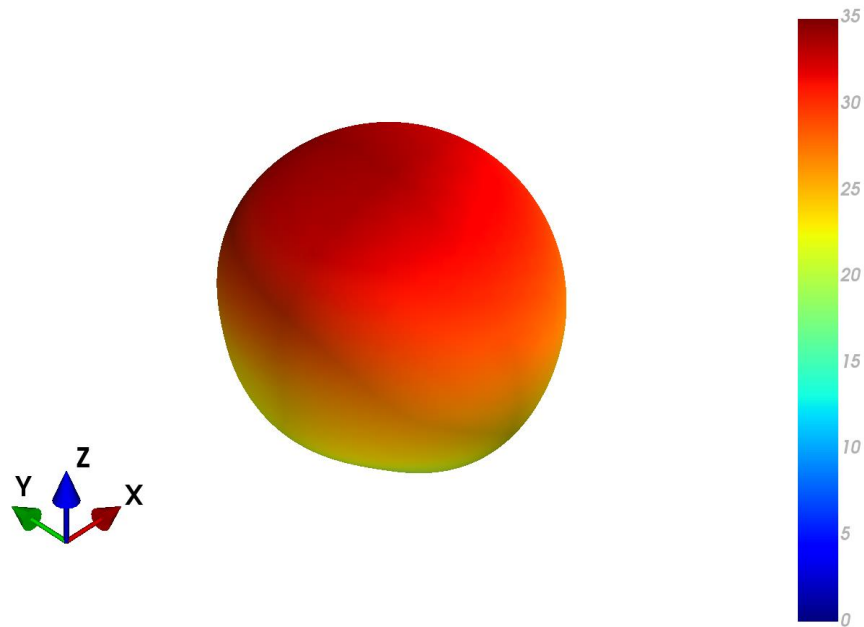

XZ Plane YZ Plane XY Plane

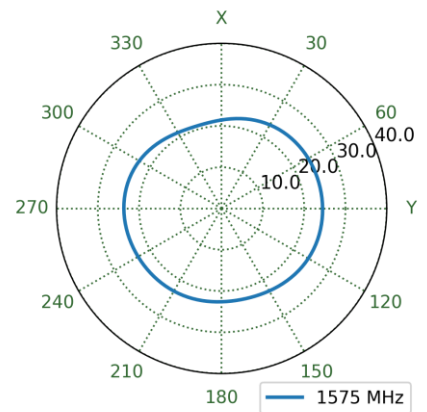
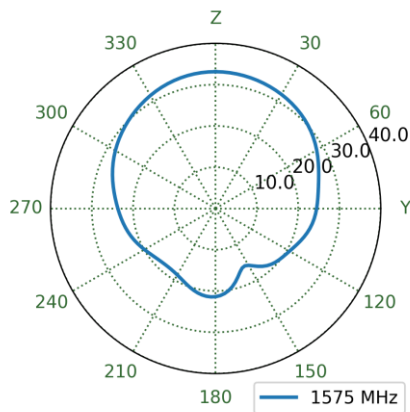
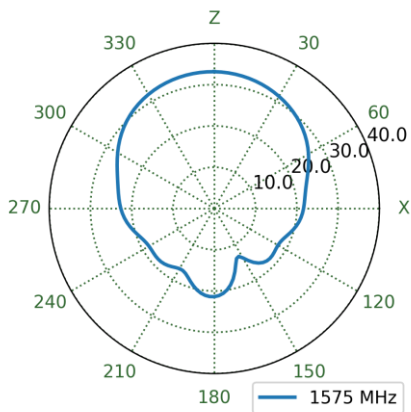

4.11 GNSS Free Space Patterns at 1562 MHz

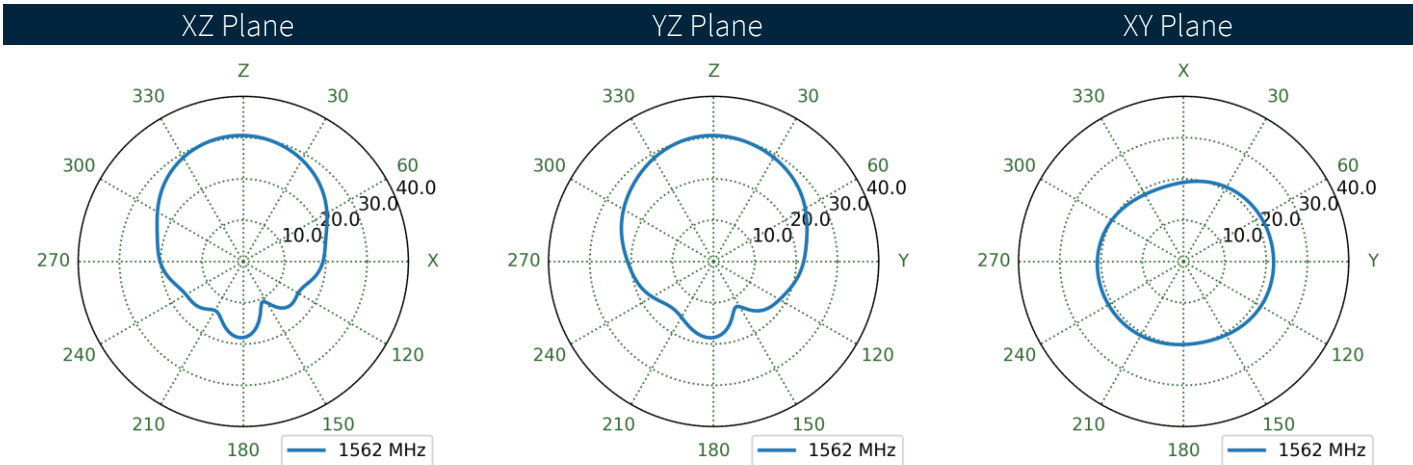
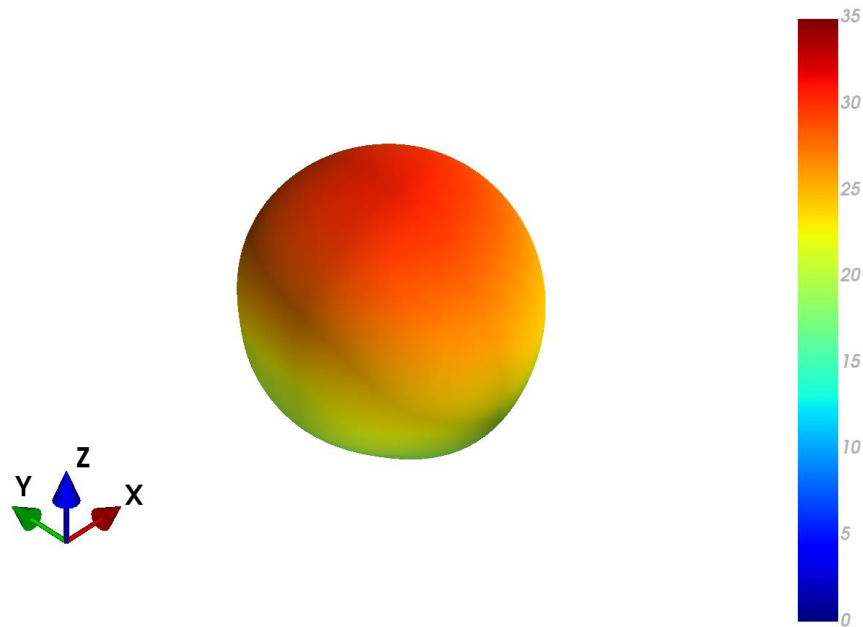

4.12 GNSS Free Space Patterns at 1176 MHz

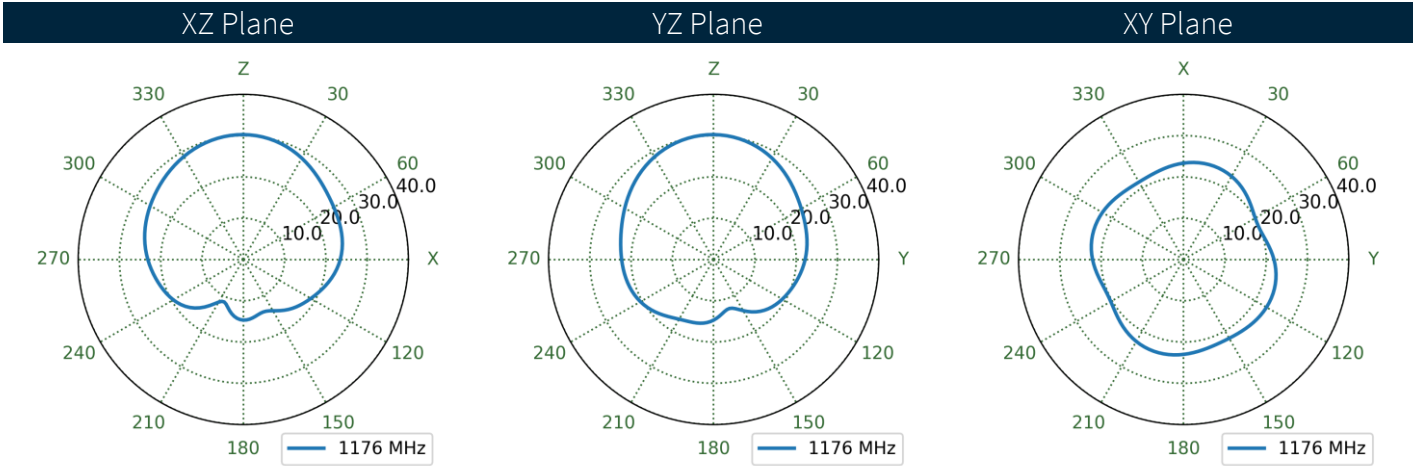
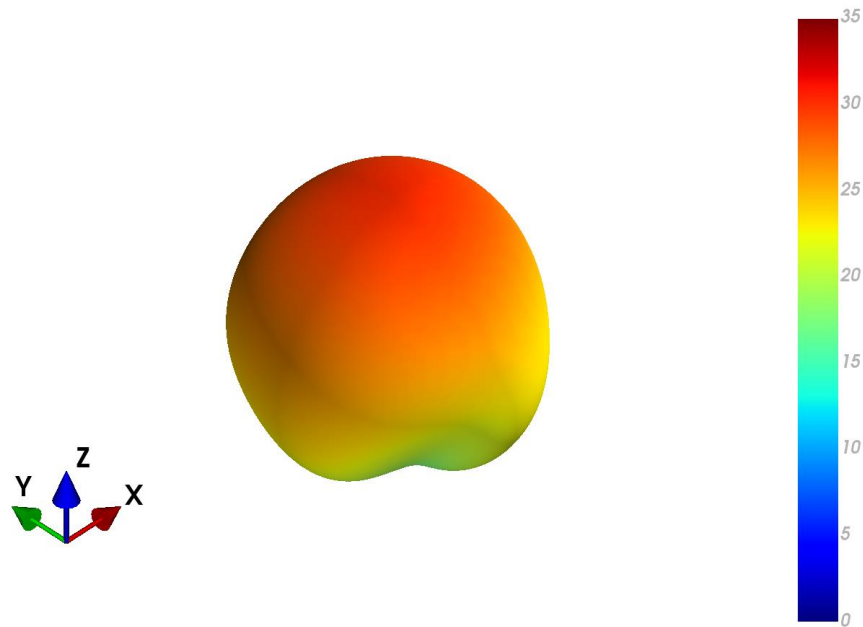

4.13 MIMO1 LTE Free Space Patterns at 658 MHz

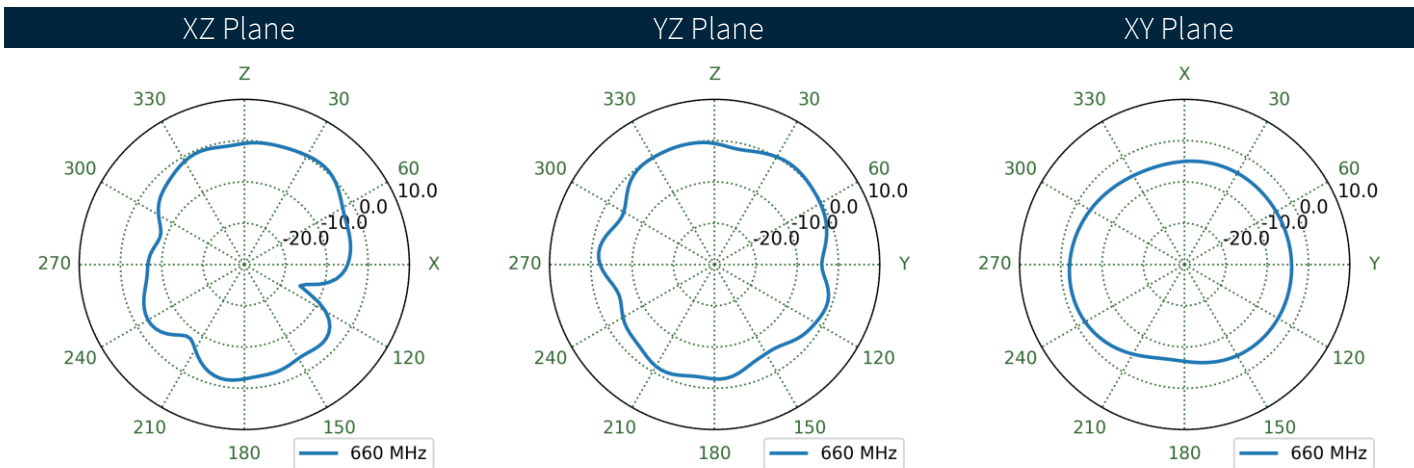
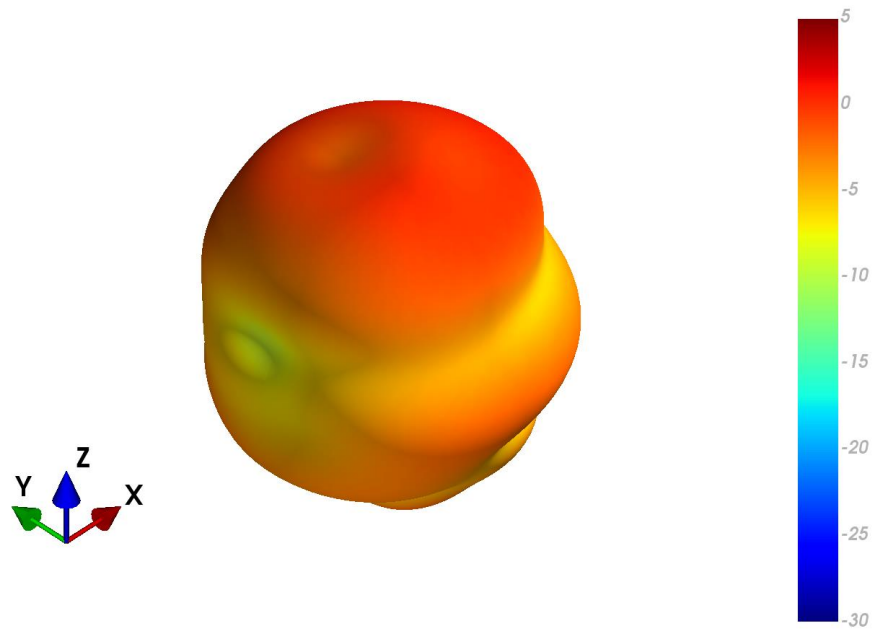

4.14 MIMO1 LTE Ground Plane Patterns at 658 MHz

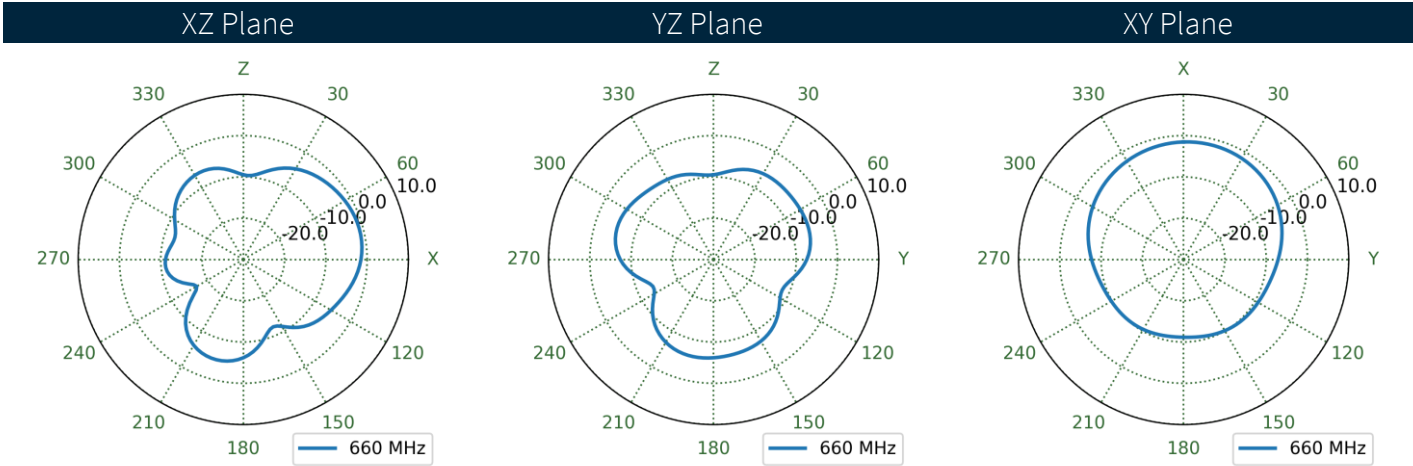
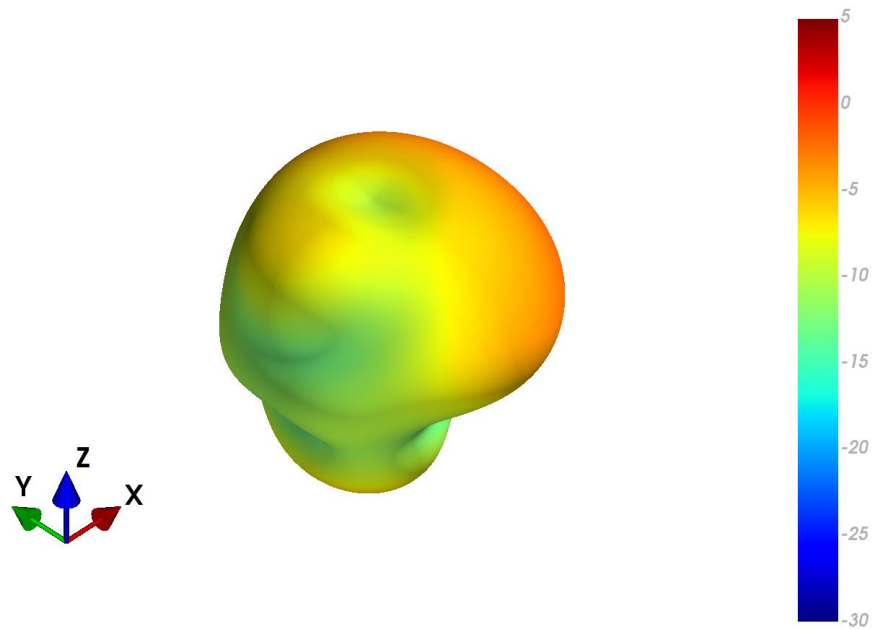

4.15 MIMO2 LTE Free Space Patterns at 658 MHz

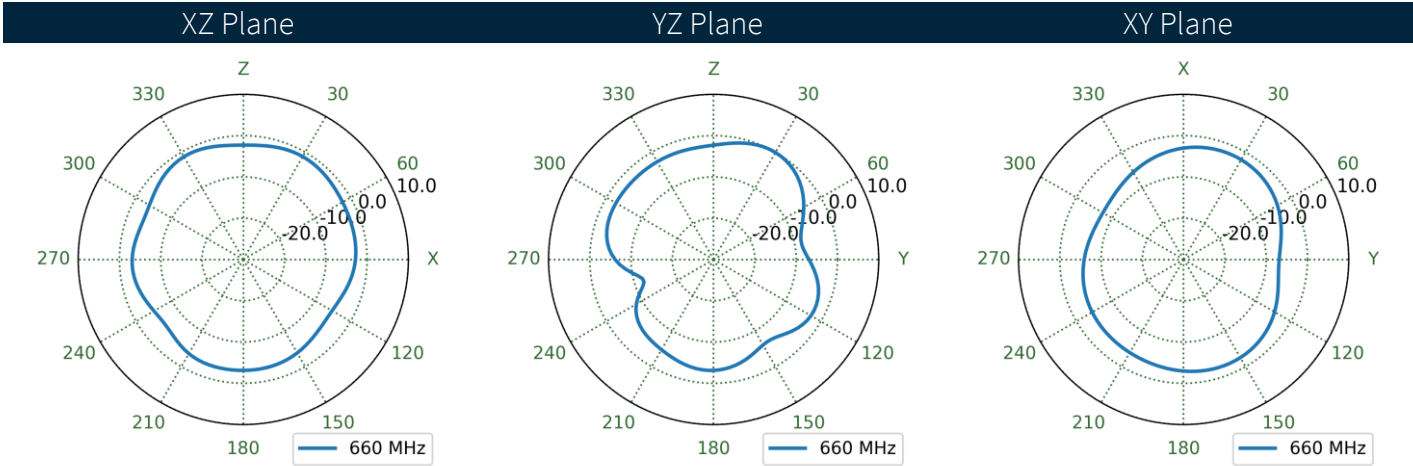
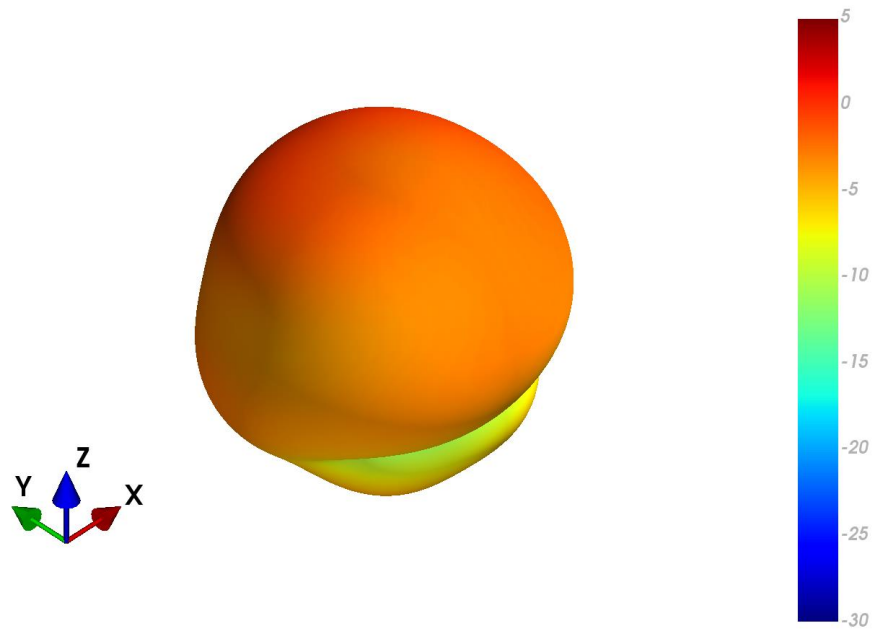

4.16 MIMO2 LTE Ground Plane Patterns at 658 MHz

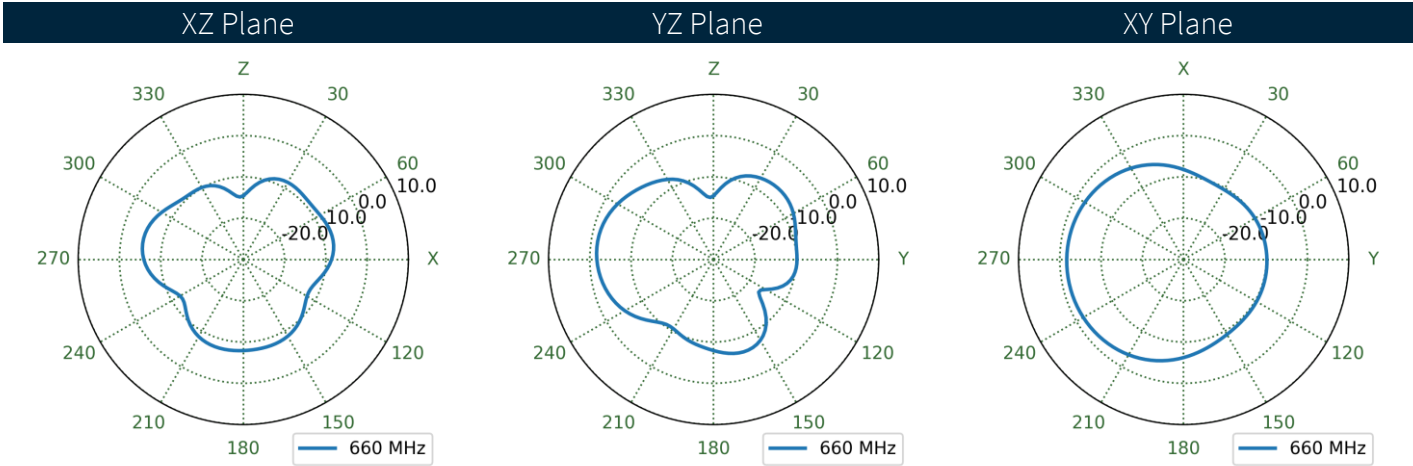
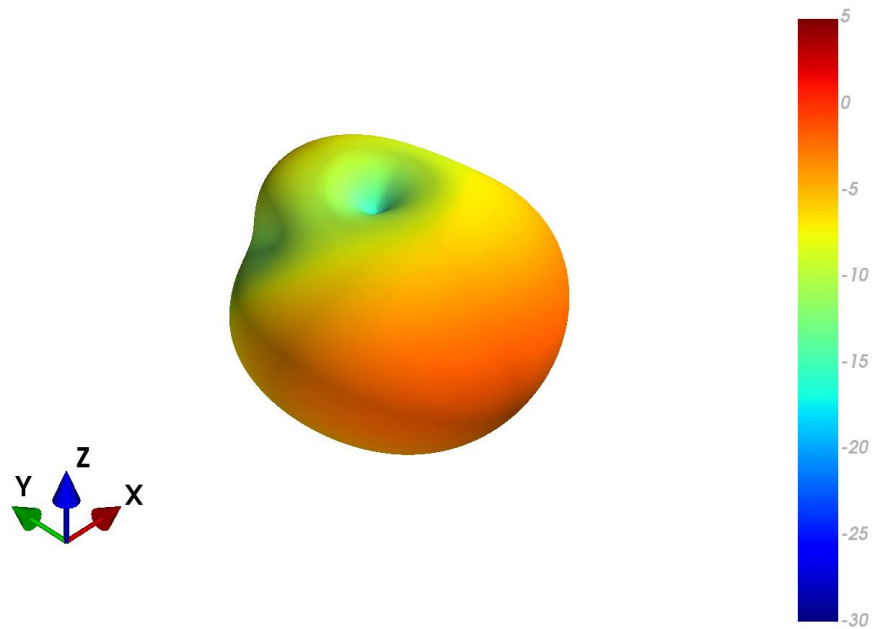

4.17 MIMO1 LTE Free Space Patterns at 752 MHz

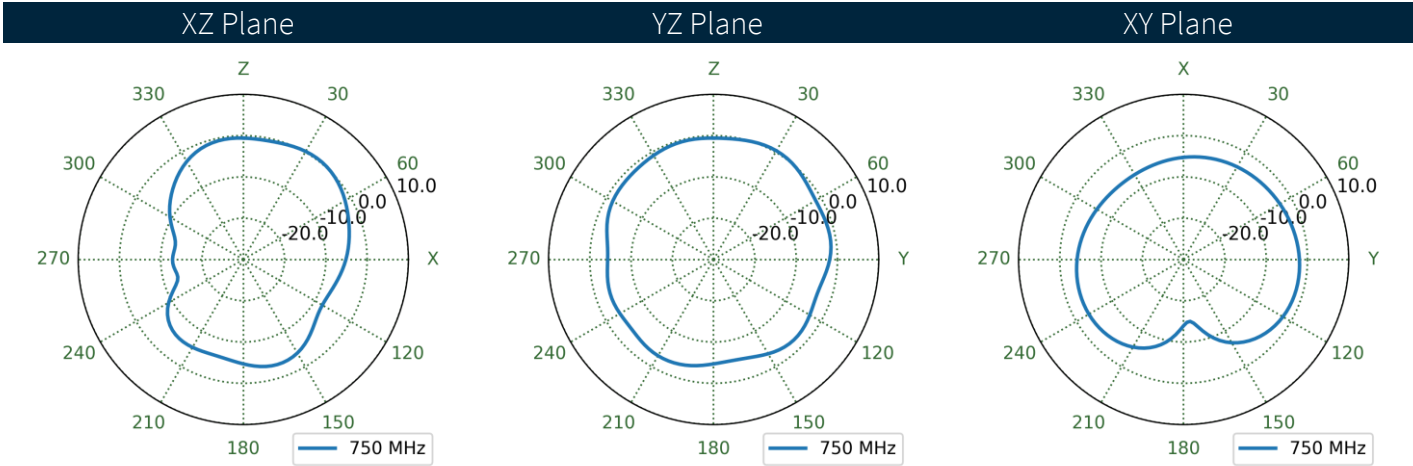
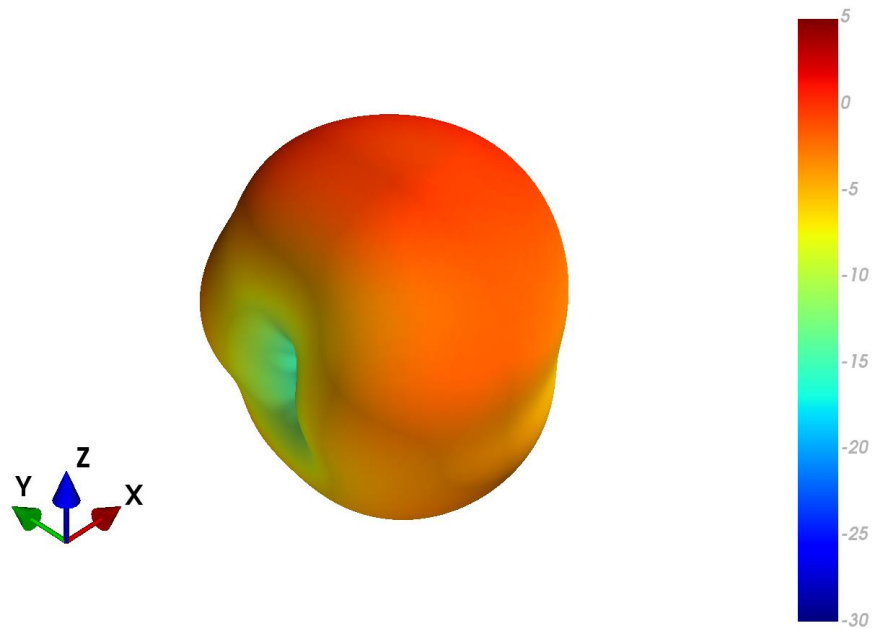

4.18 MIMO1 LTE Ground Plane Patterns at 752 MHz

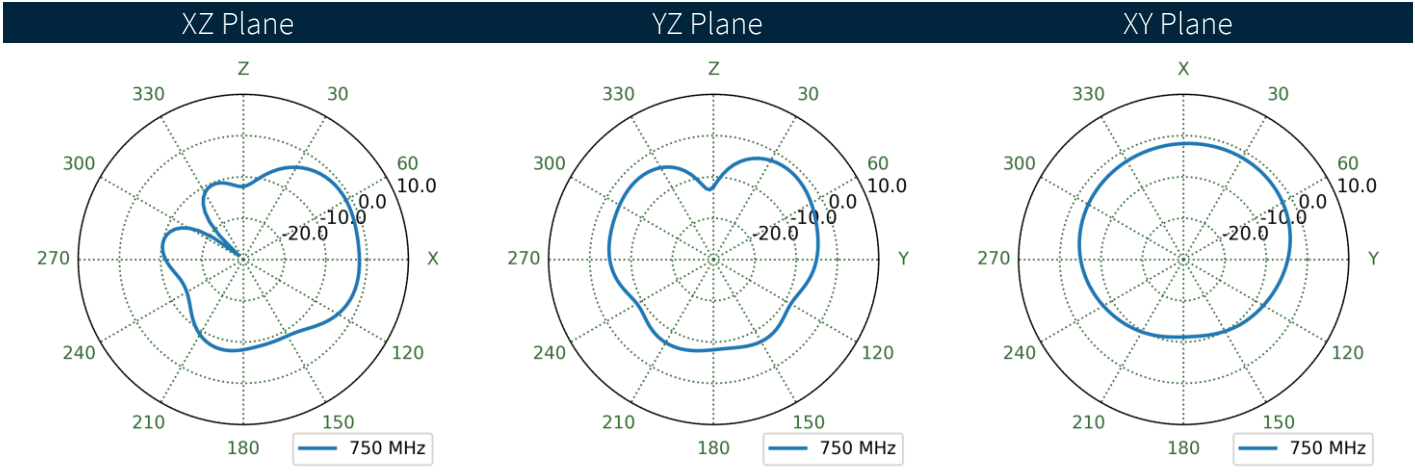
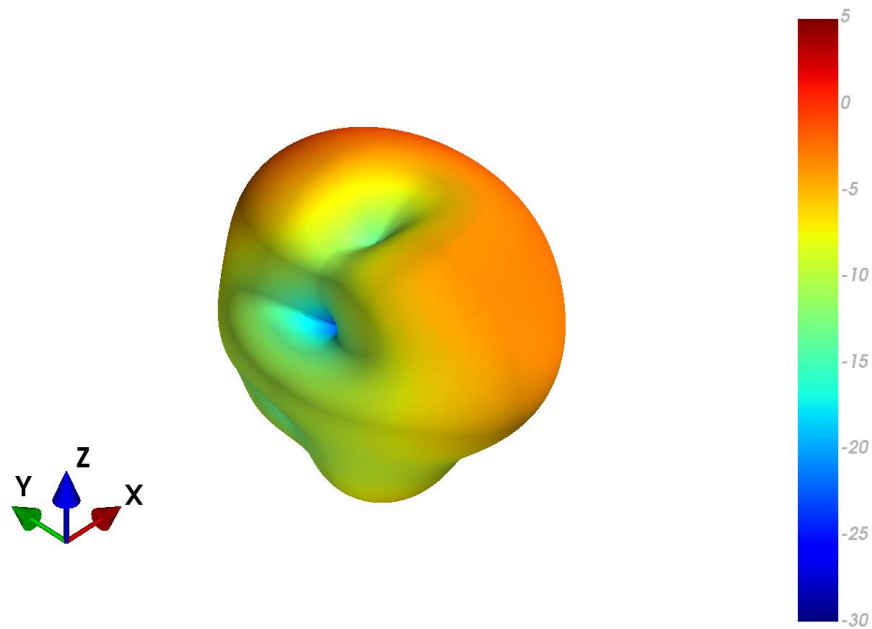

4.19 MIMO2 LTE Free Space Patterns at 752 MHz

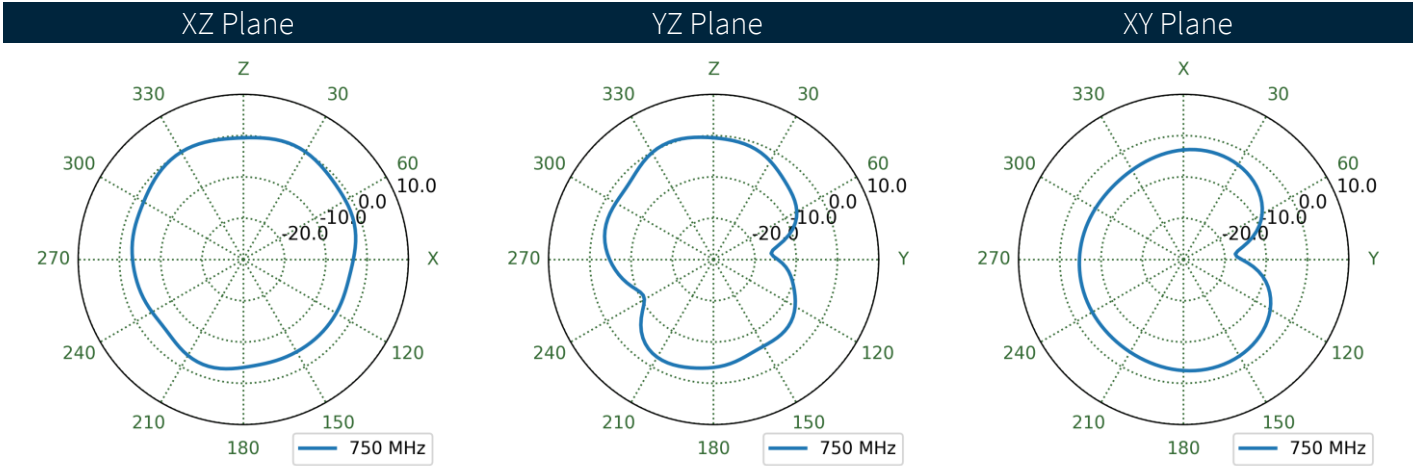
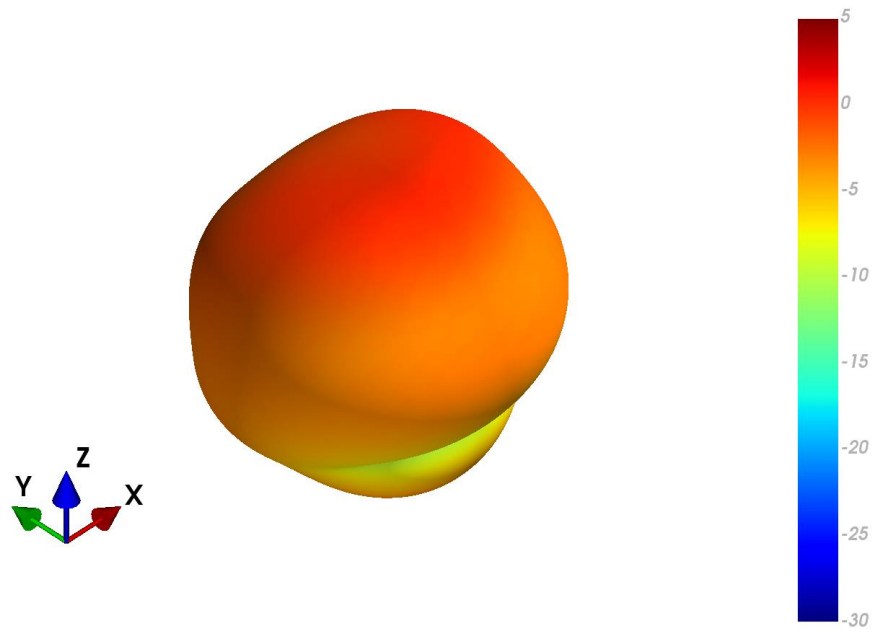

4.20 MIMO2 LTE Ground Plane Patterns at 752 MHz

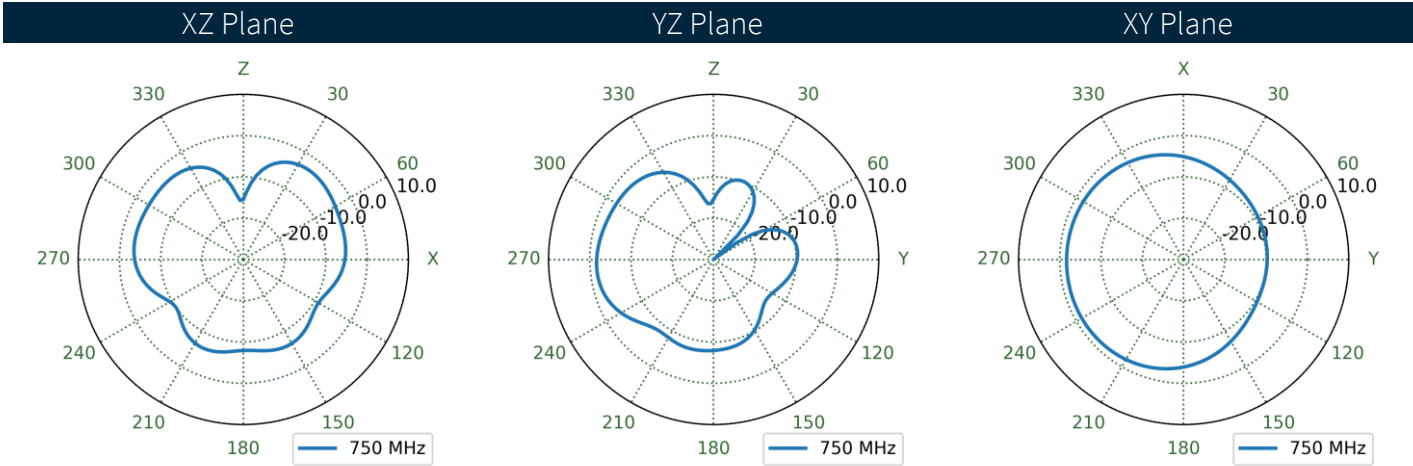
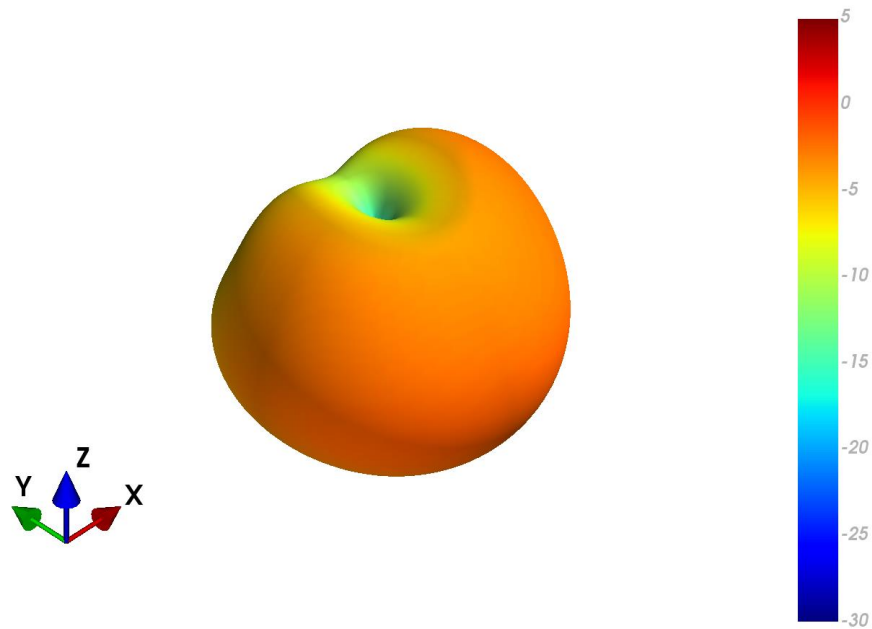

4.21 MIMO1 LTE Free Space Patterns at 892 MHz

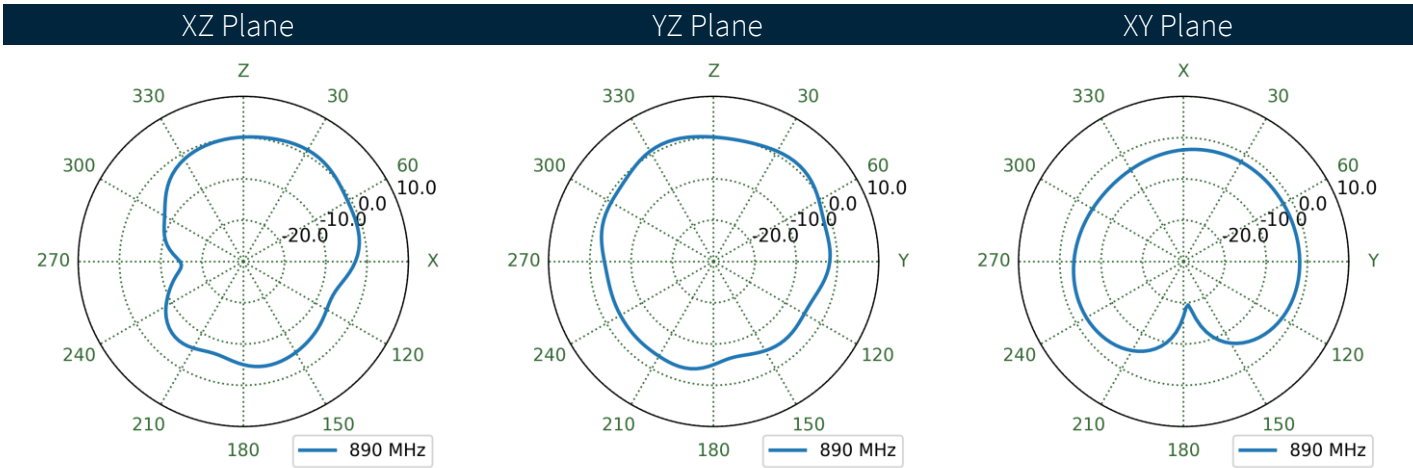
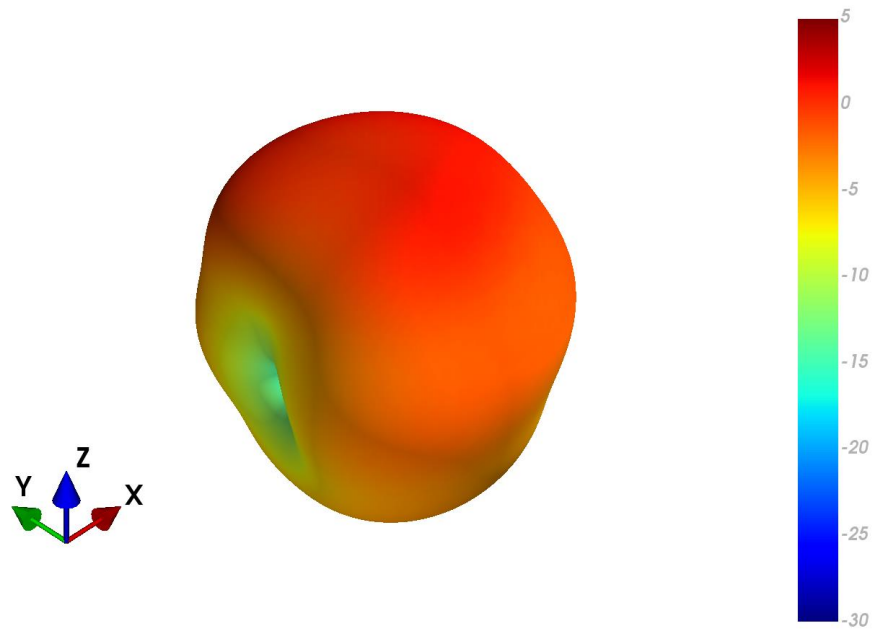

4.22 MIMO1 LTE Ground Plane Patterns at 892 MHz

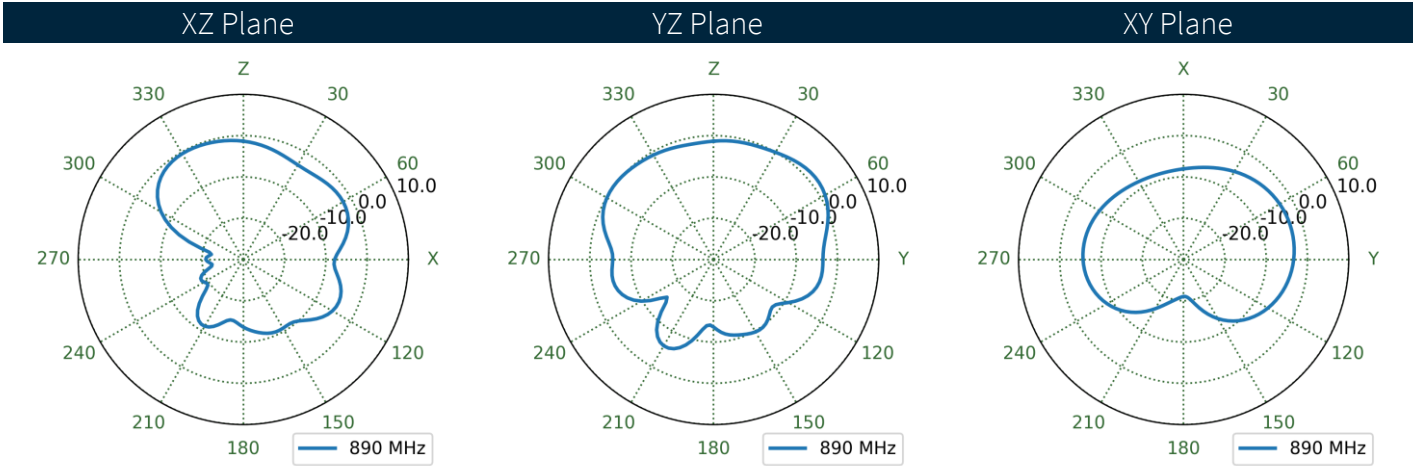
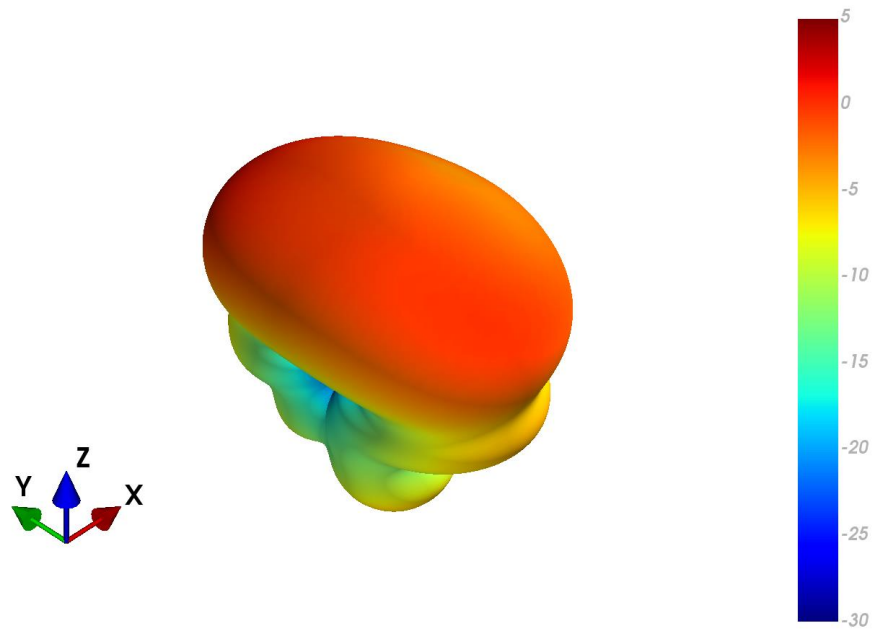

4.23 MIMO2 LTE Free Space Patterns at 892 MHz

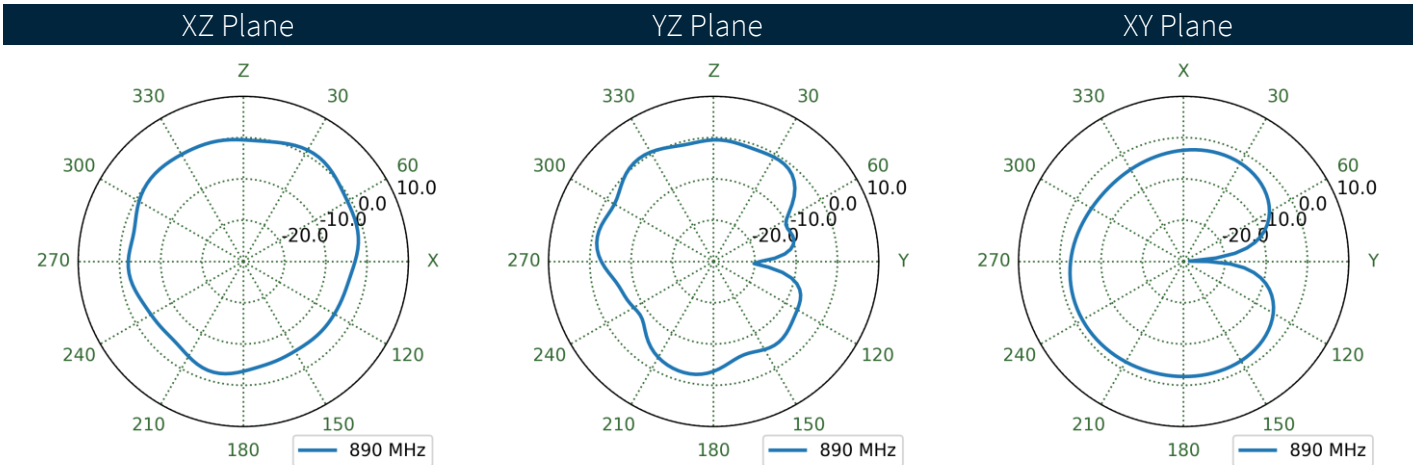
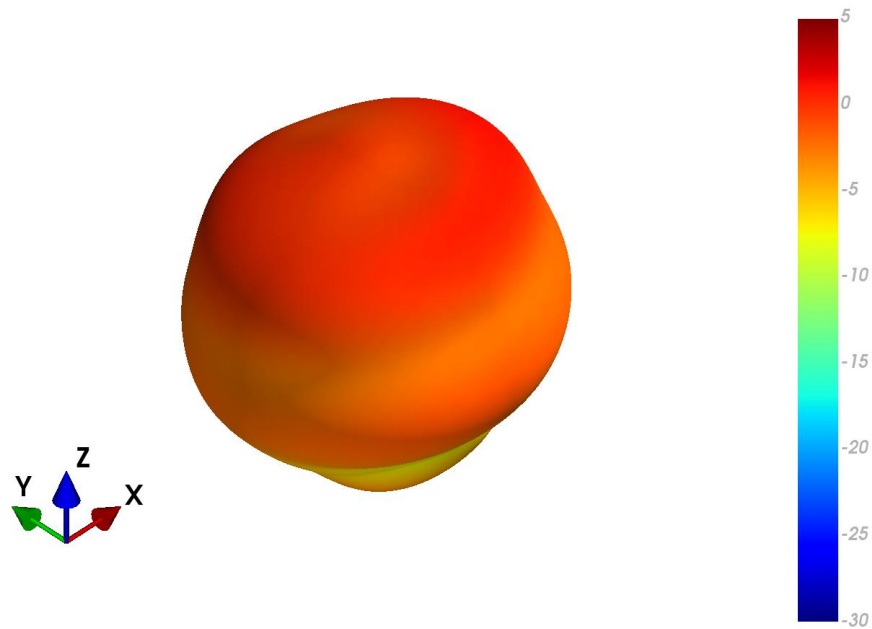

4.24 MIMO2 LTE Ground Plane Patterns at 892 MHz

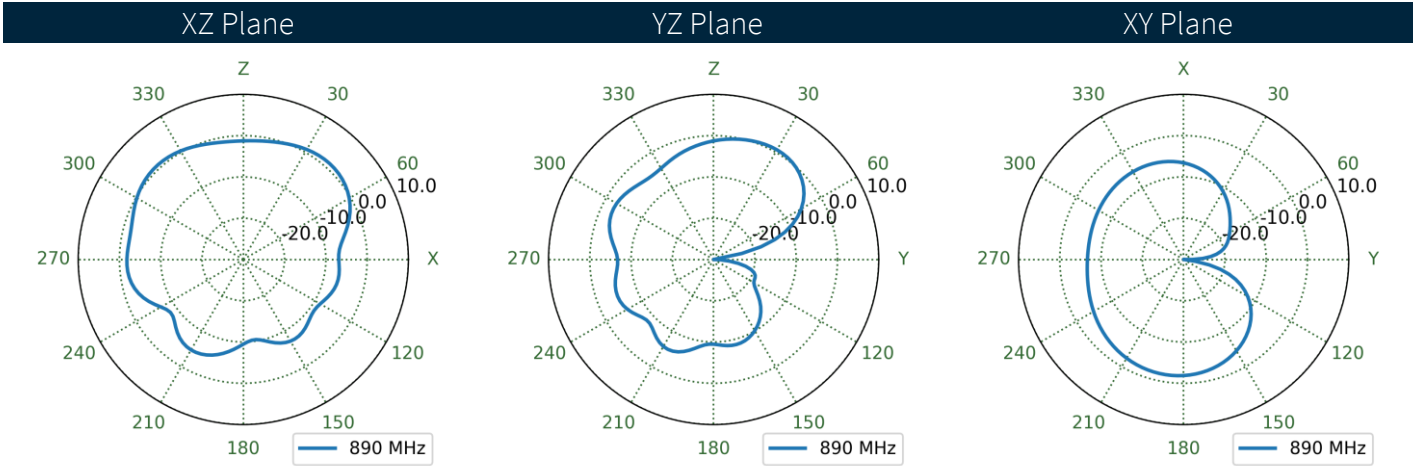
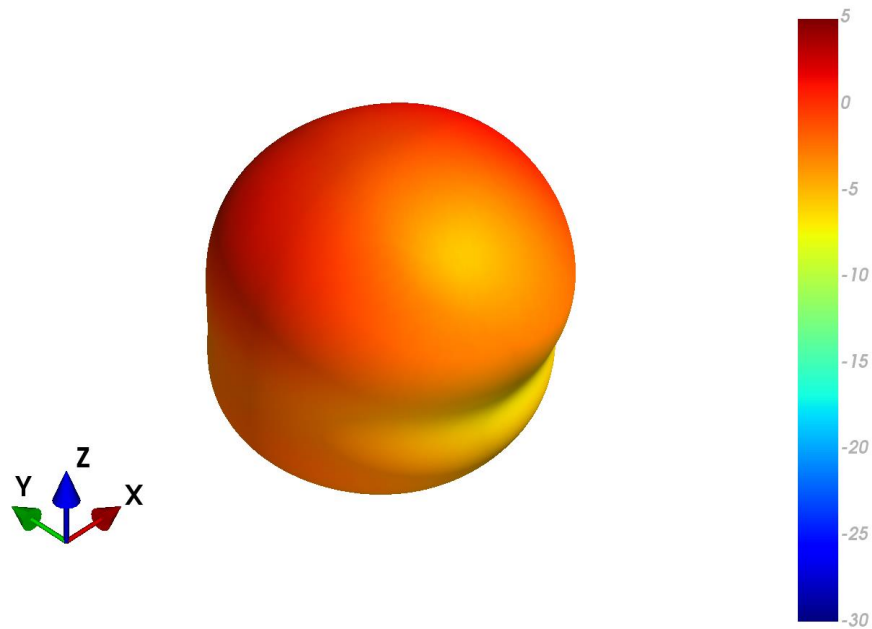

4.25 MIMO1 LTE Free Space Patterns at 1473 MHz

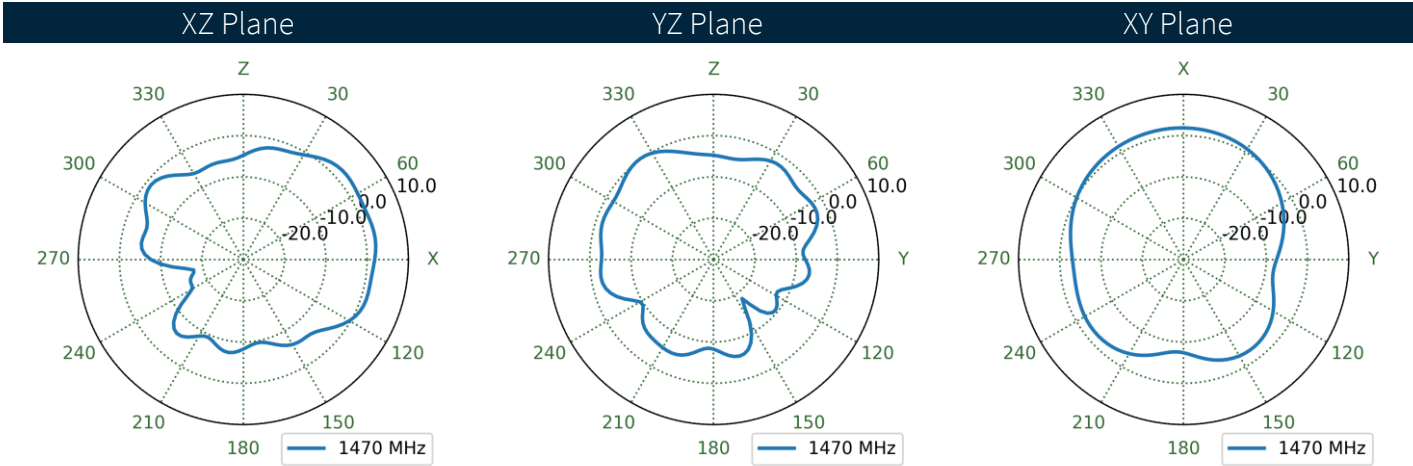
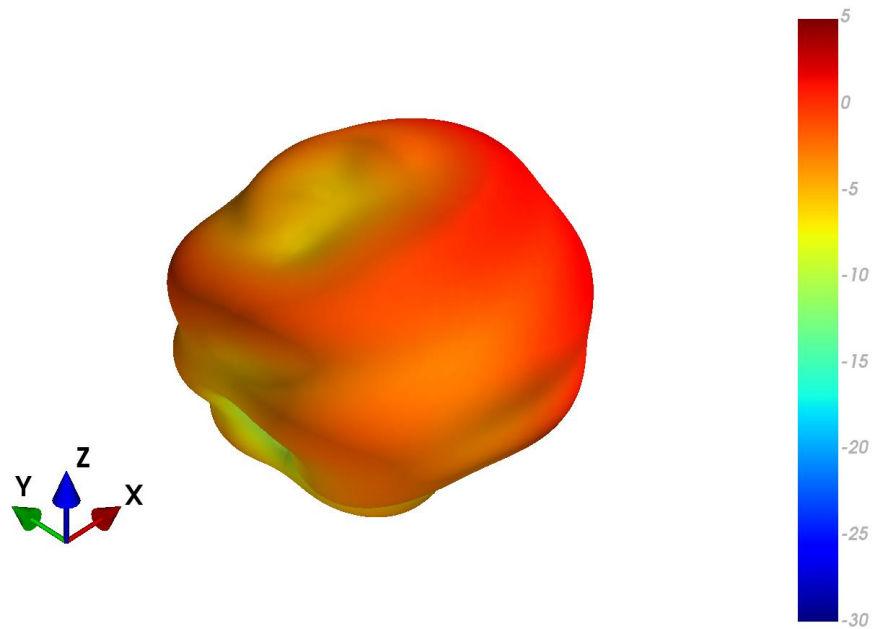

4.26 MIMO1 LTE Ground Plane Patterns at 1473 MHz

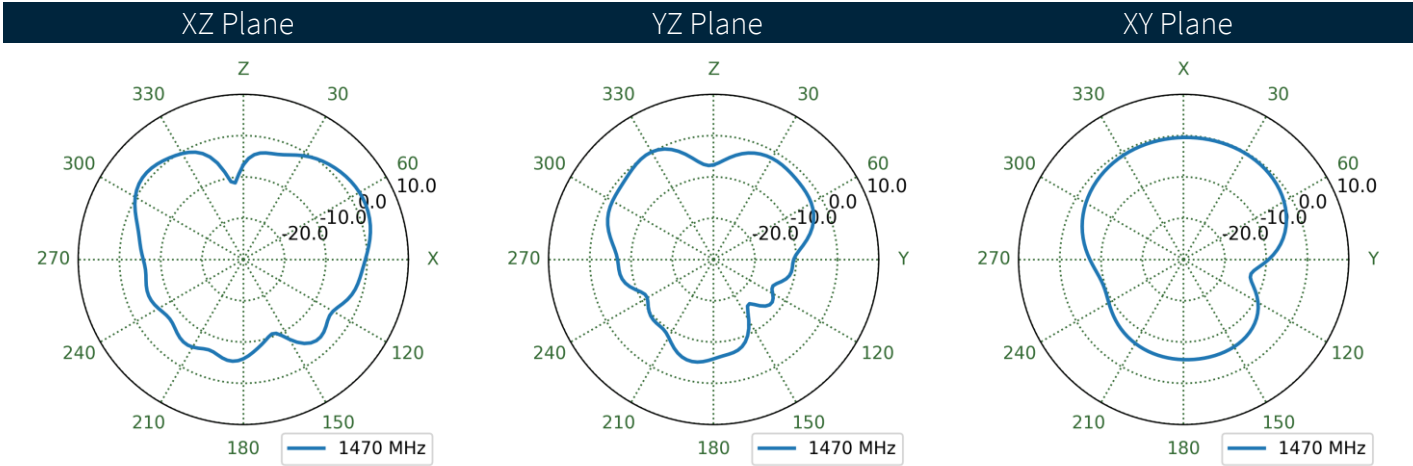
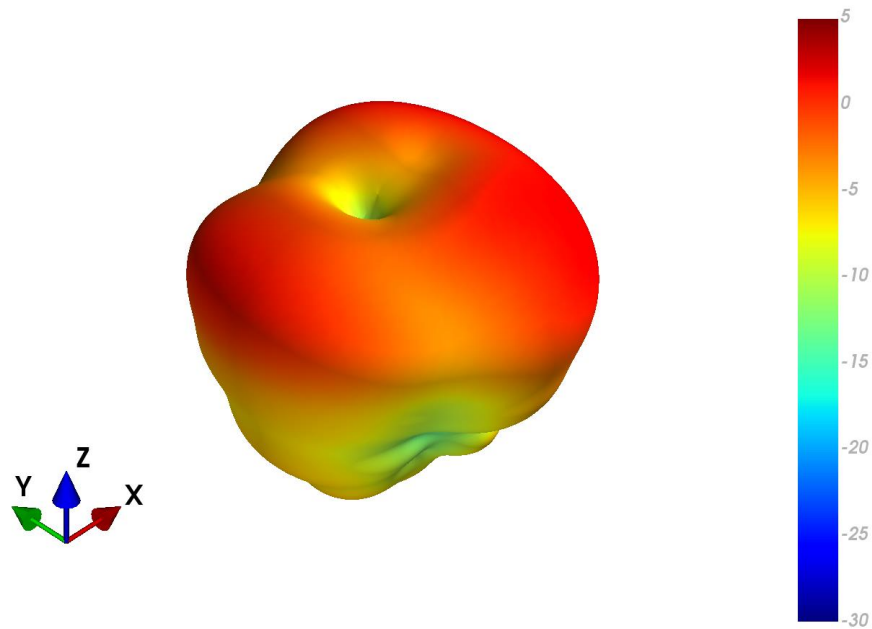

4.27 MIMO2 LTE Free Space Patterns at 1473 MHz

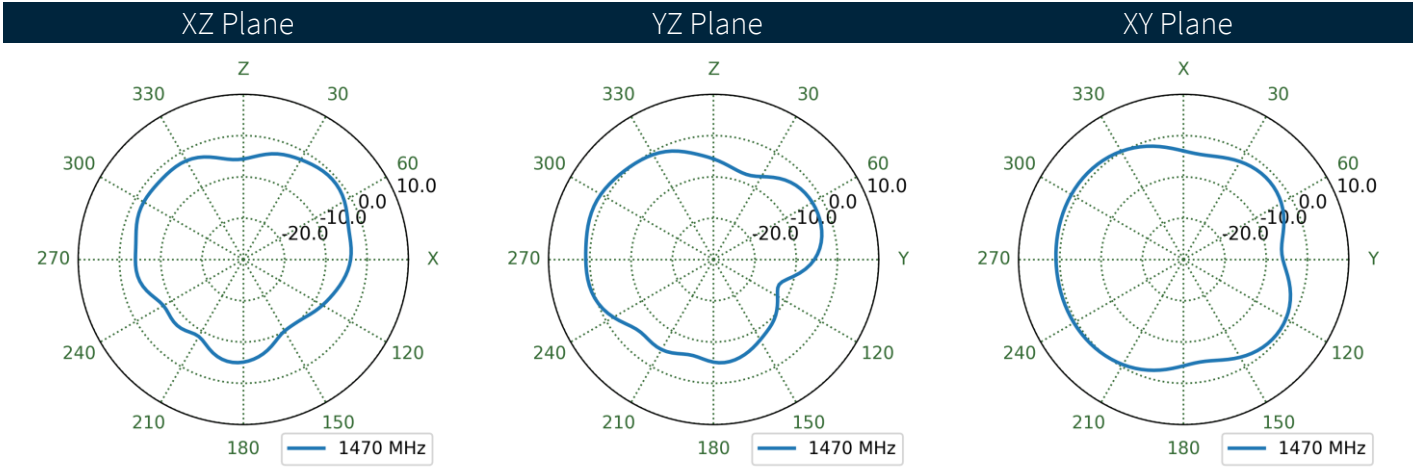
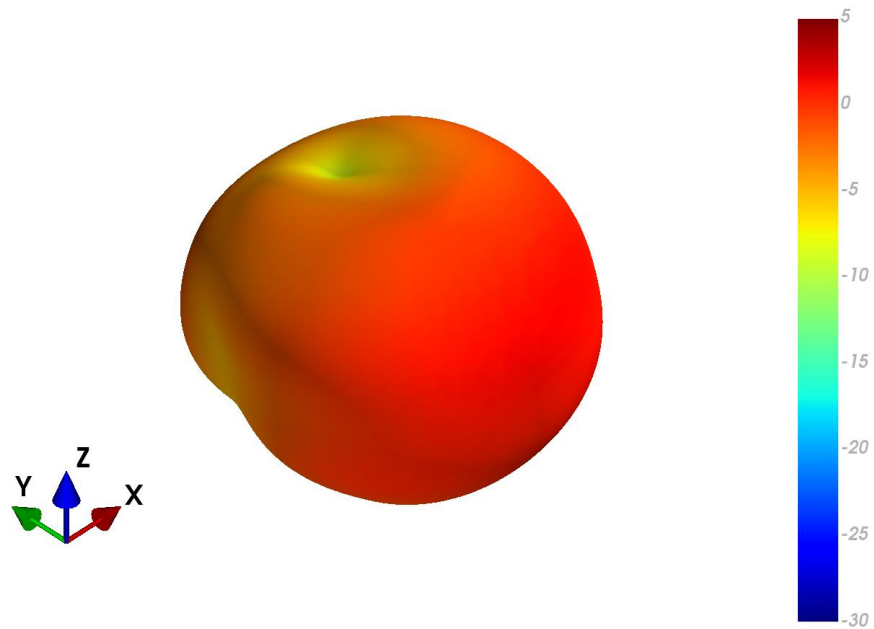

4.28 MIMO2 LTE Ground Plane Patterns at 1473 MHz

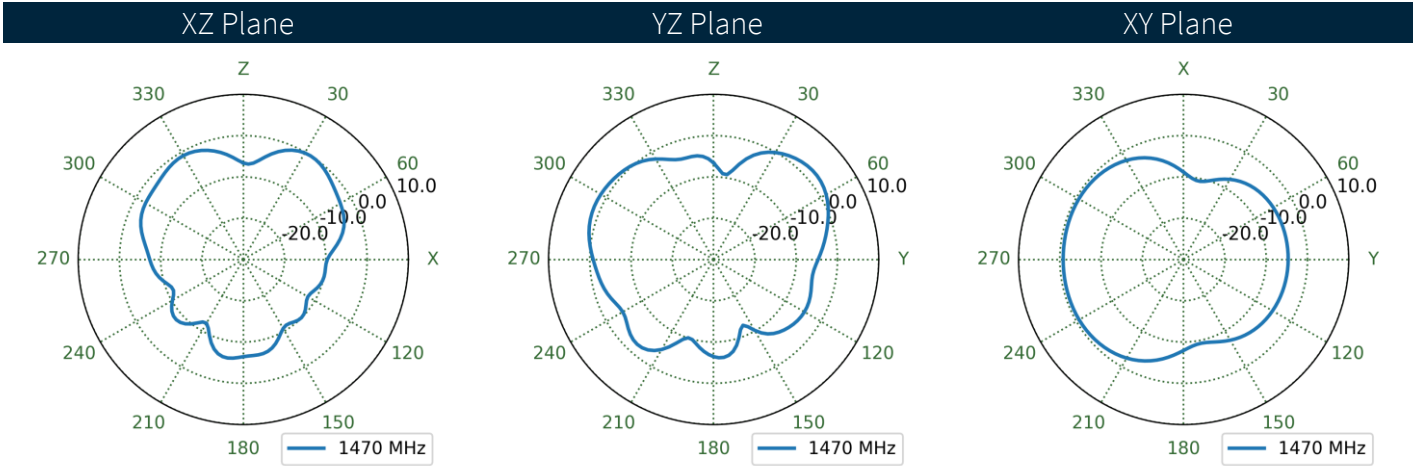
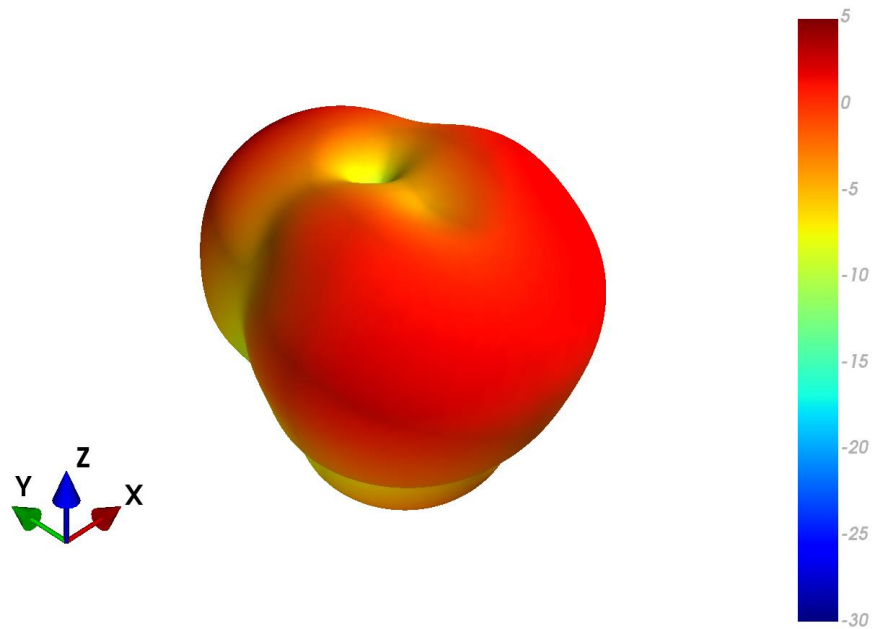

4.29 MIMO1 LTE Free Space Patterns at 1955 MHz

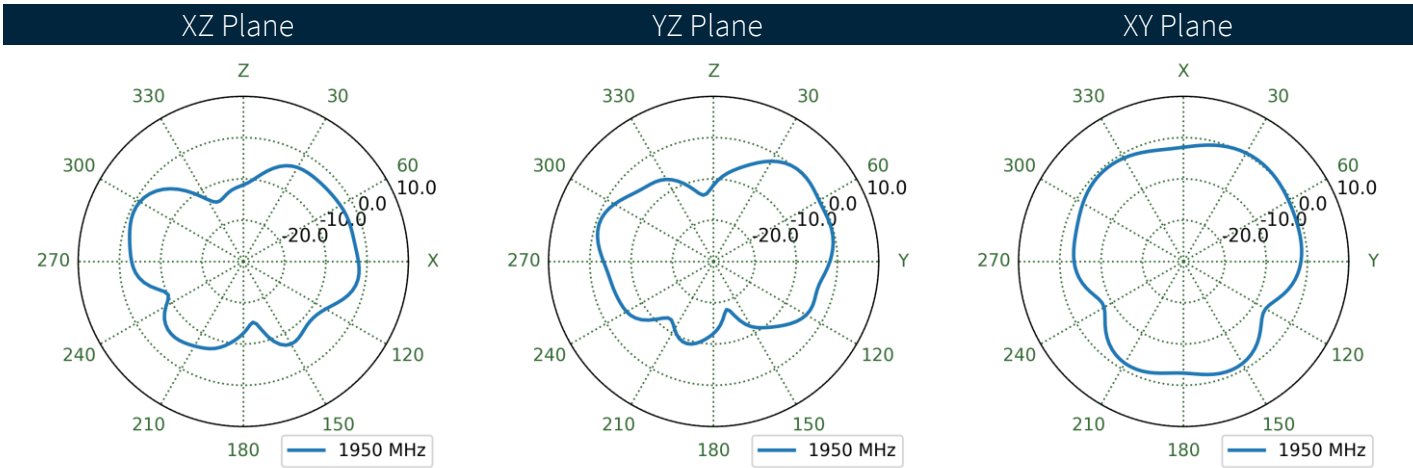
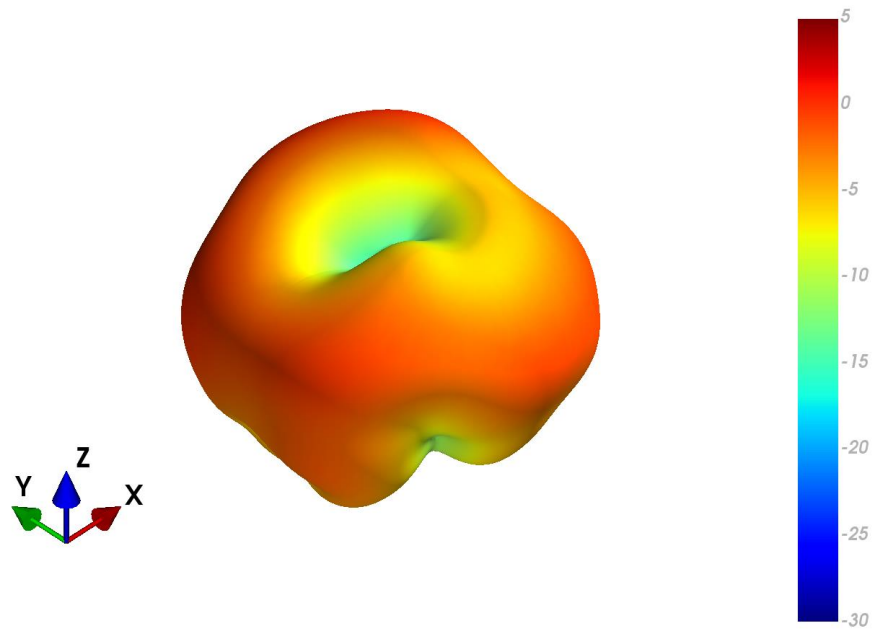

4.30 MIMO1 LTE Ground Plane Patterns at 1955 MHz

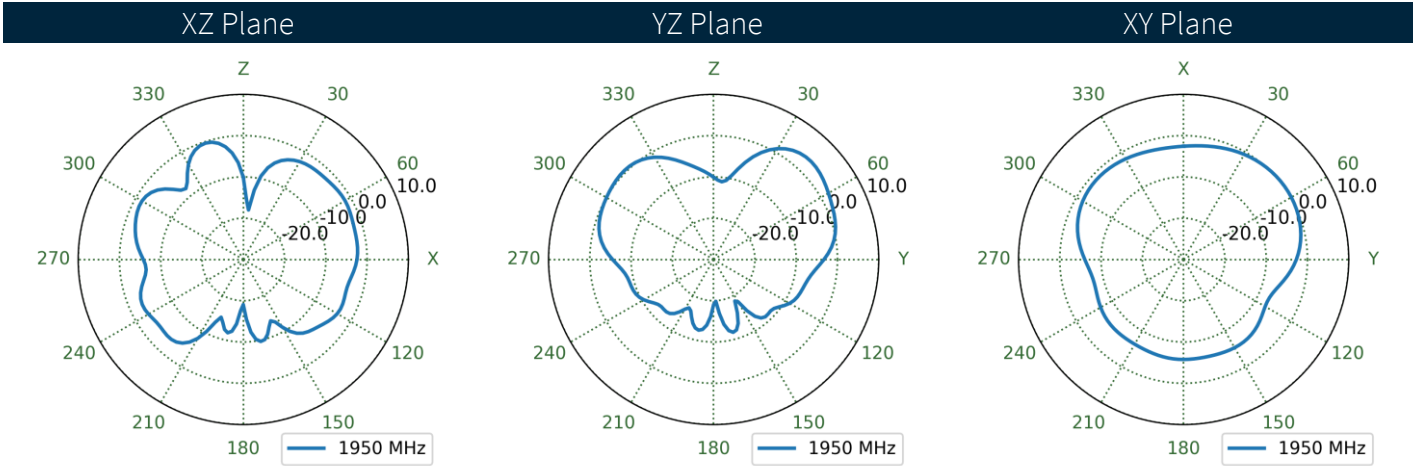
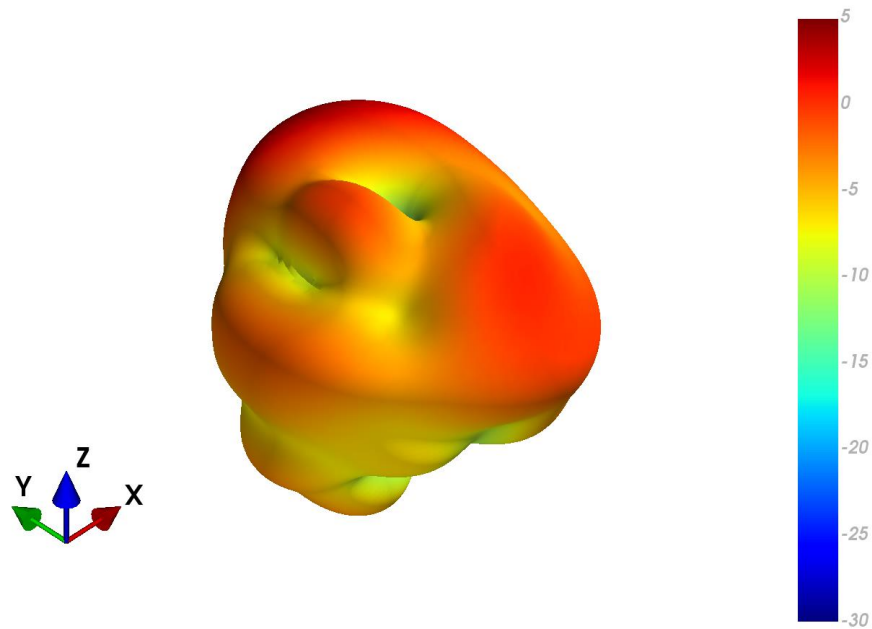

4.31 MIMO2 LTE Free Space Patterns at 1955 MHz

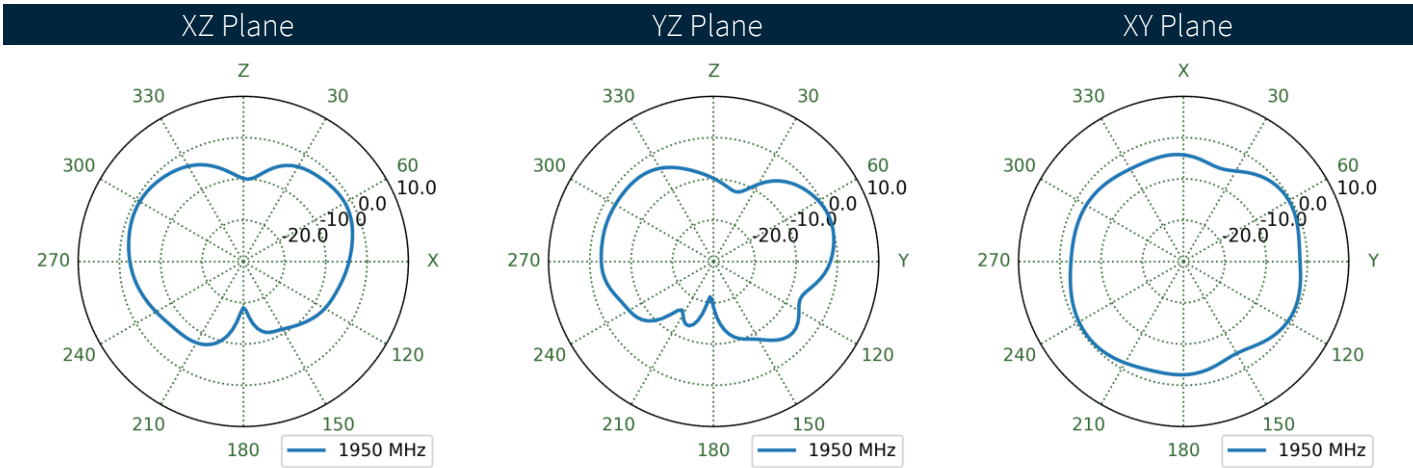
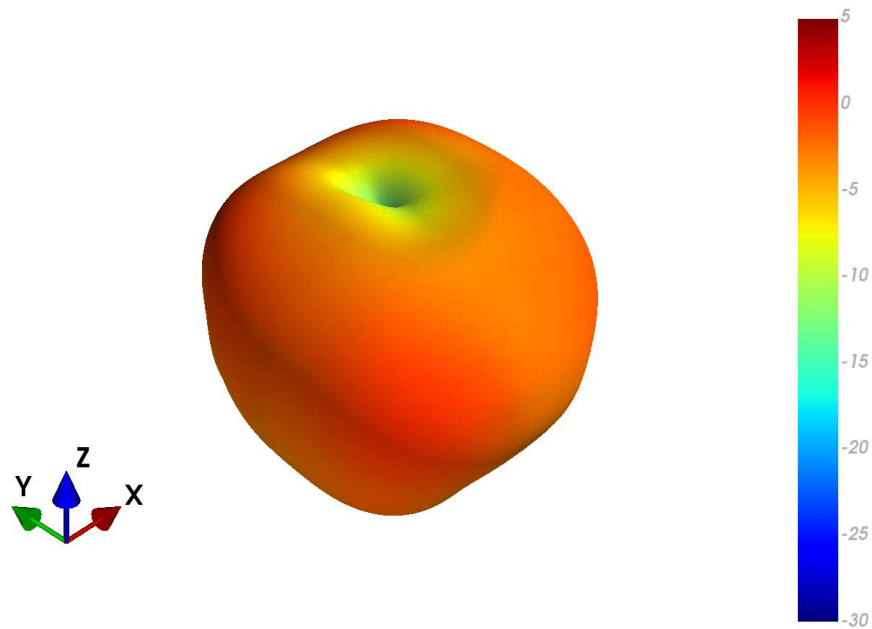

4.32 MIMO2 LTE Ground Plane Patterns at 1955 MHz

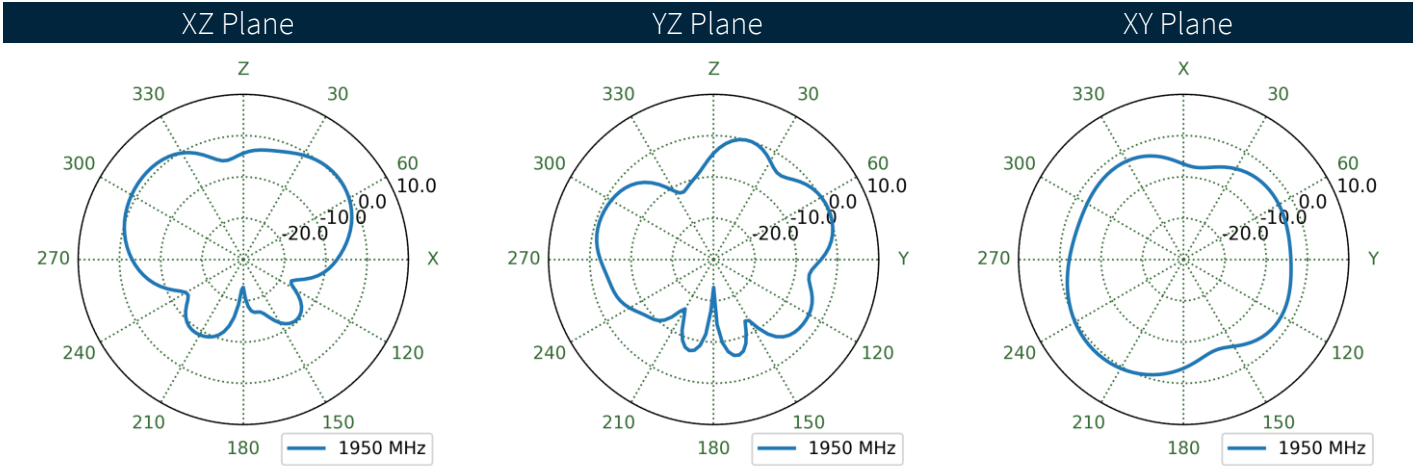
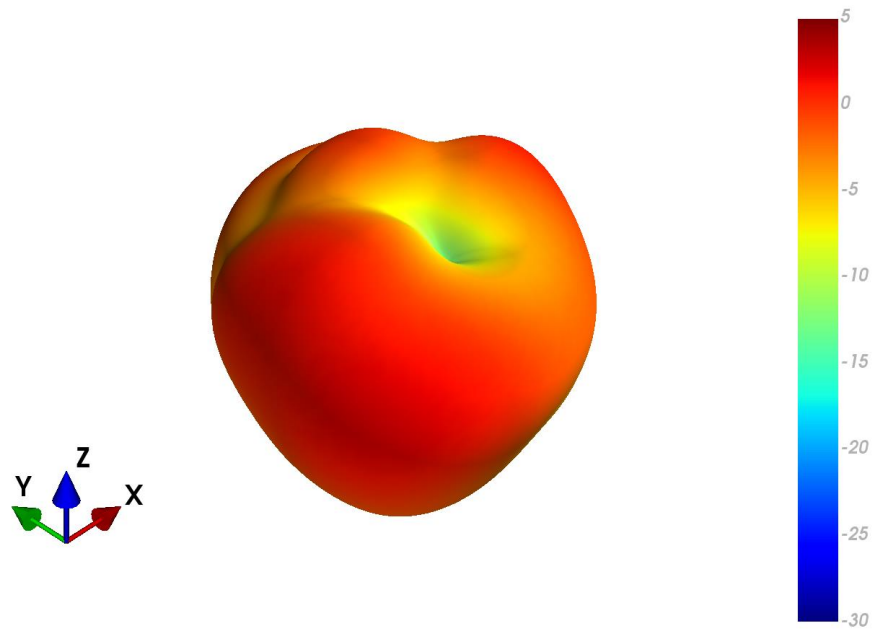

4.33 MIMO1 LTE Free Space Patterns at 2495 MHz

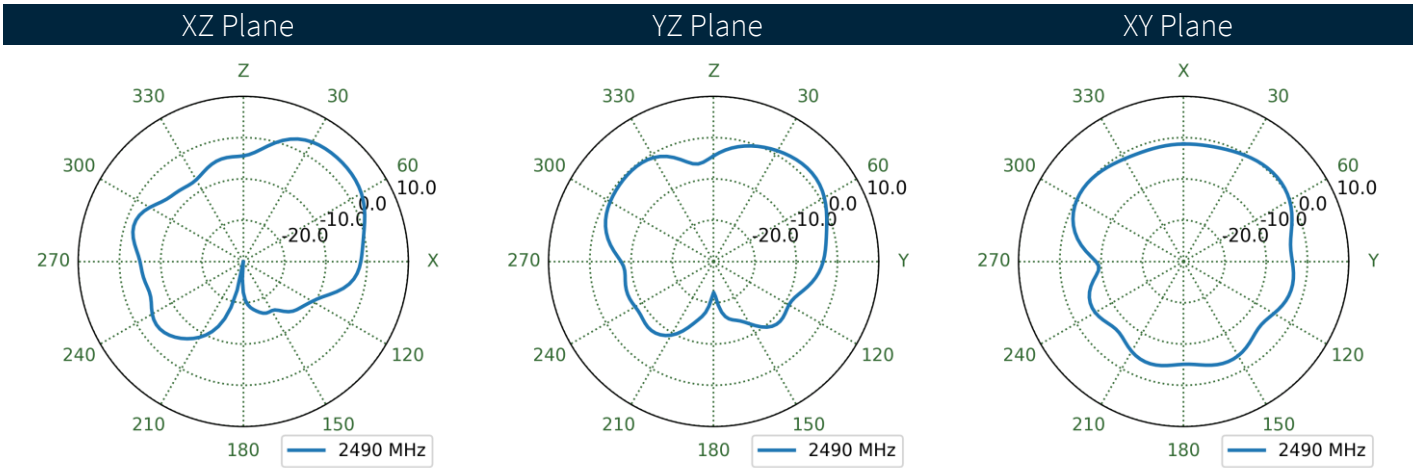
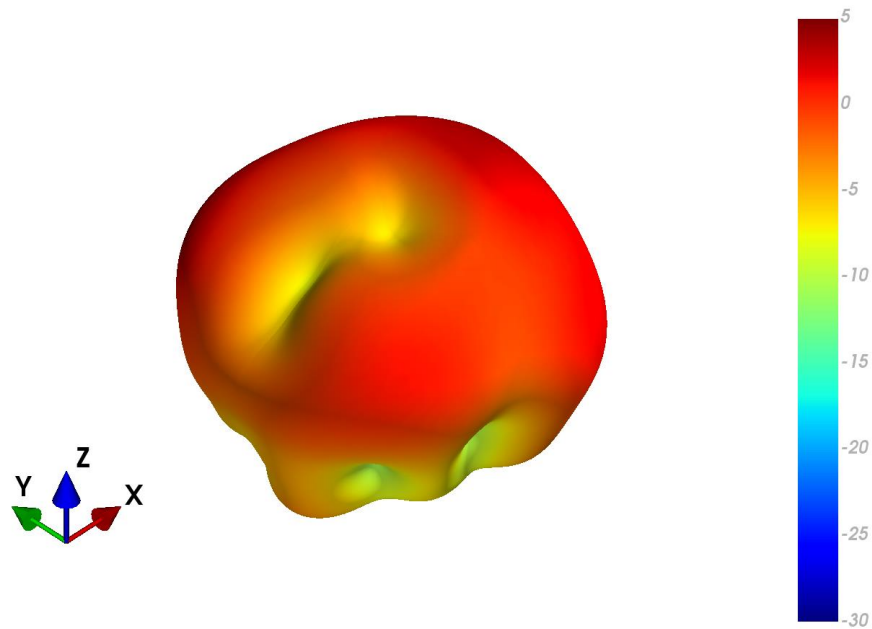

4.34 MIMO1 LTE Ground Plane Patterns at 2495 MHz

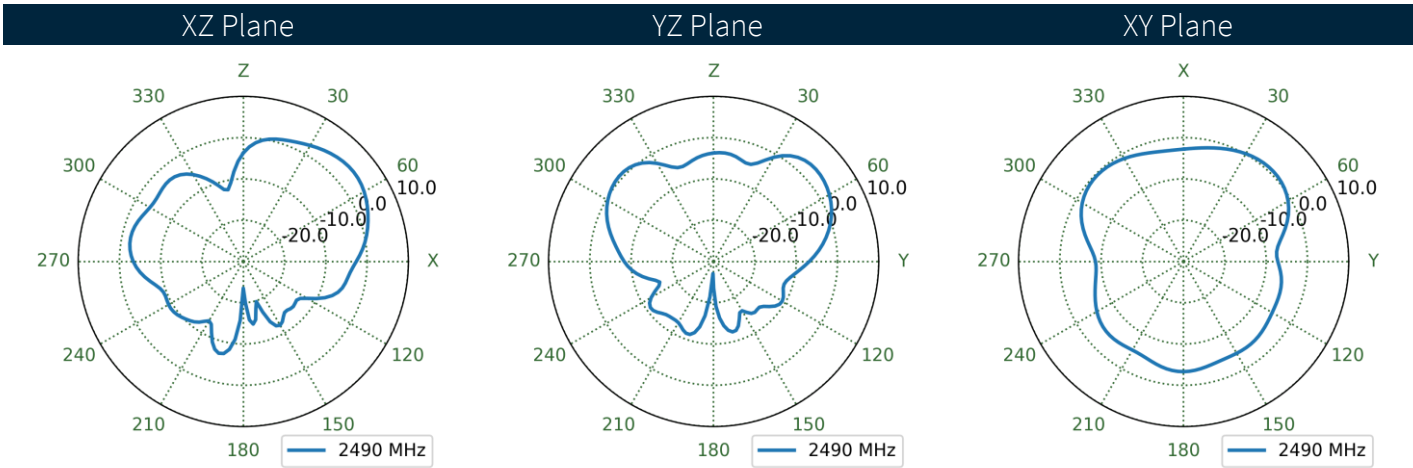
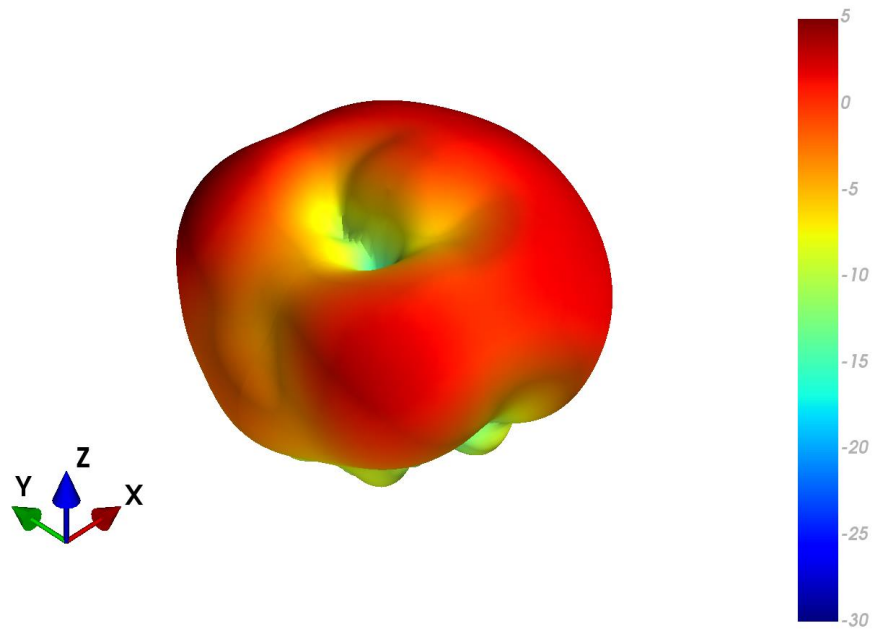

4.35 MIMO2 LTE Free Space Patterns at 2495 MHz

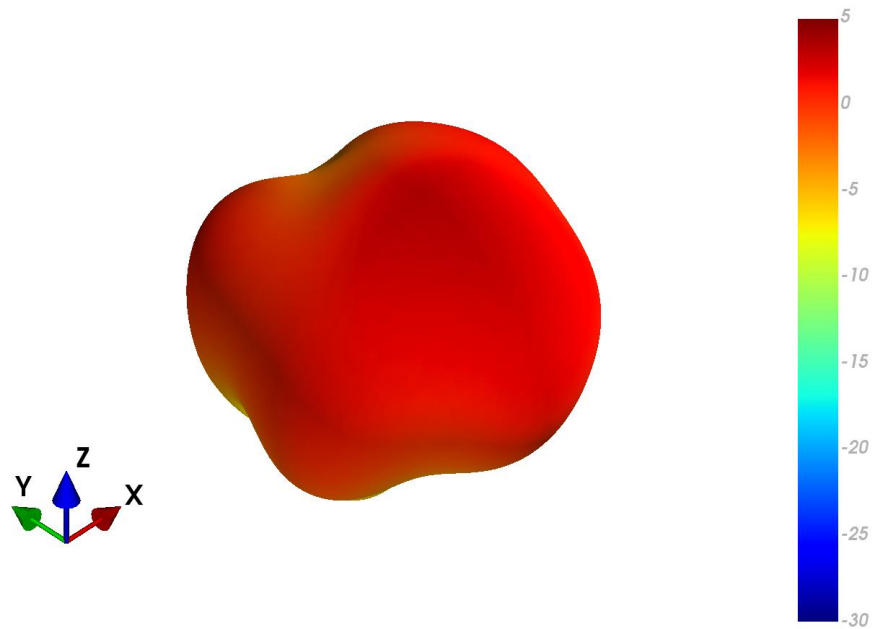

XZ Plane YZ Plane XY Plane

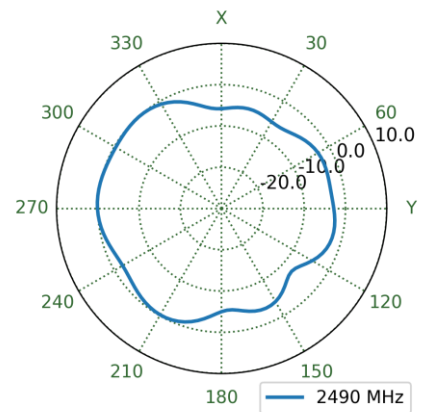
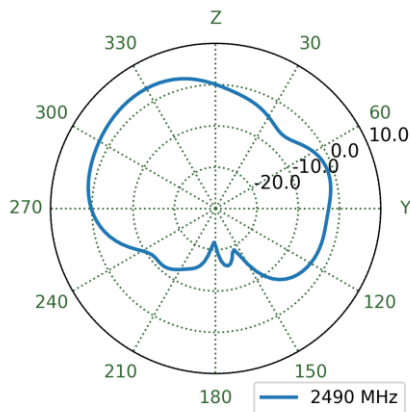
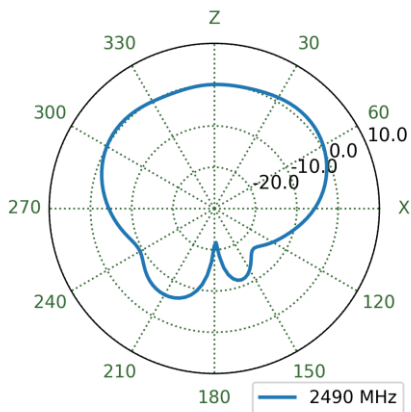

4.36 MIMO2 LTE Ground Plane Patterns at 2495 MHz

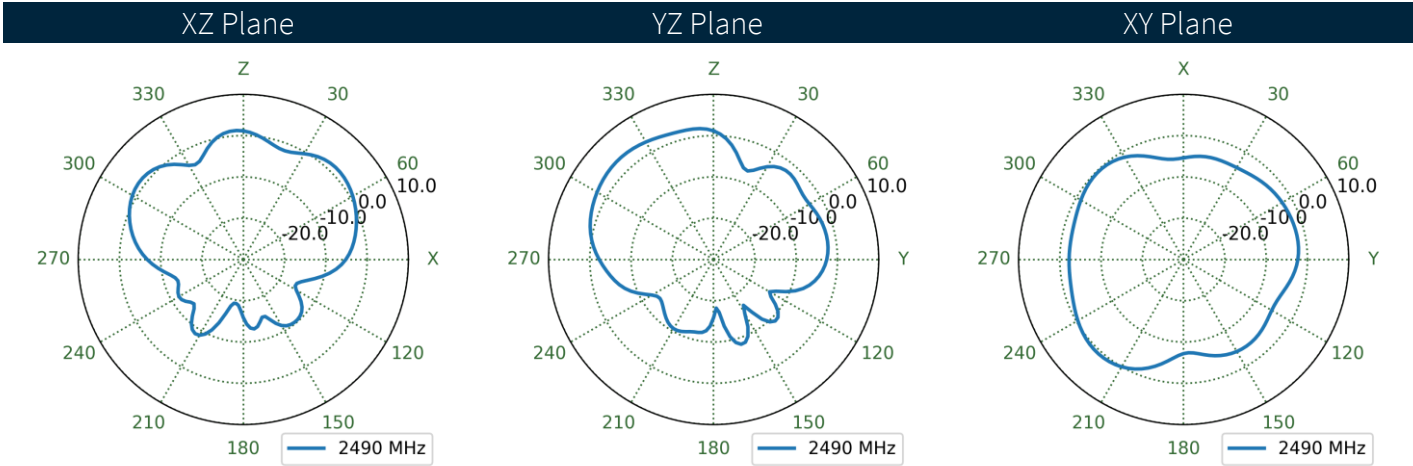
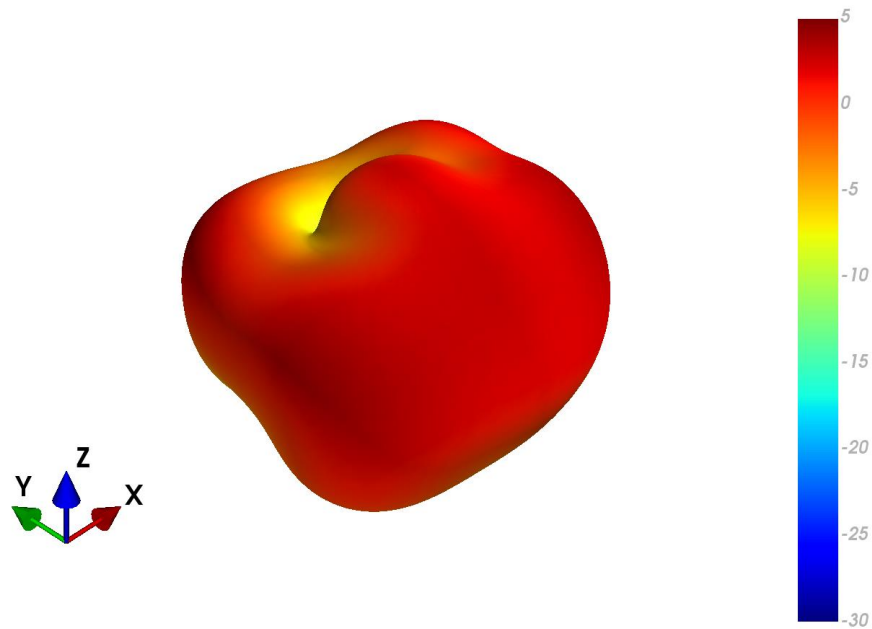

4.37 MIMO1 LTE Free Space Patterns at 4150 MHz

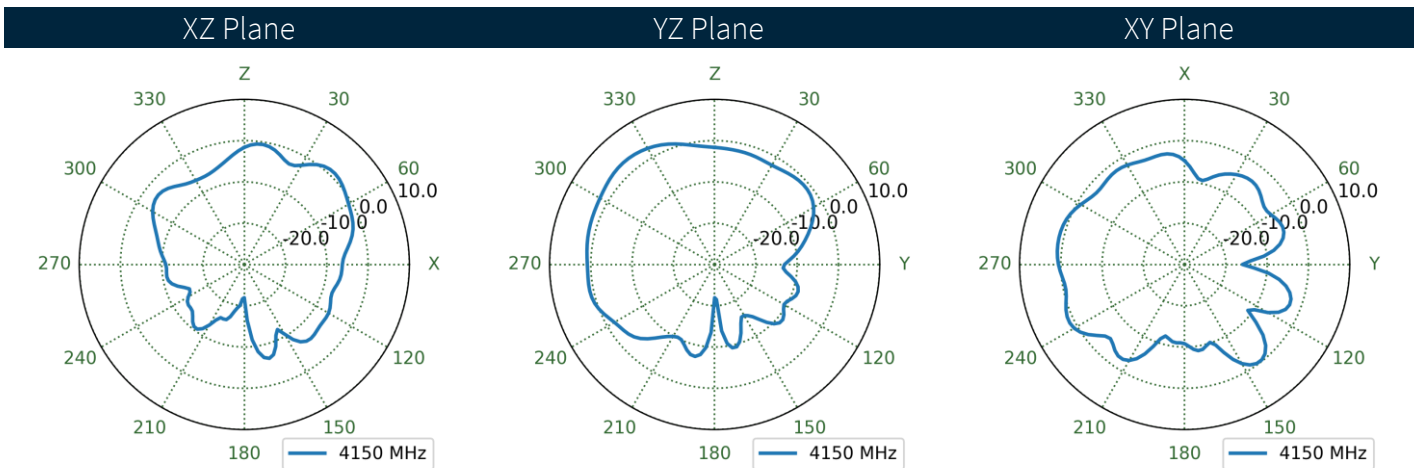
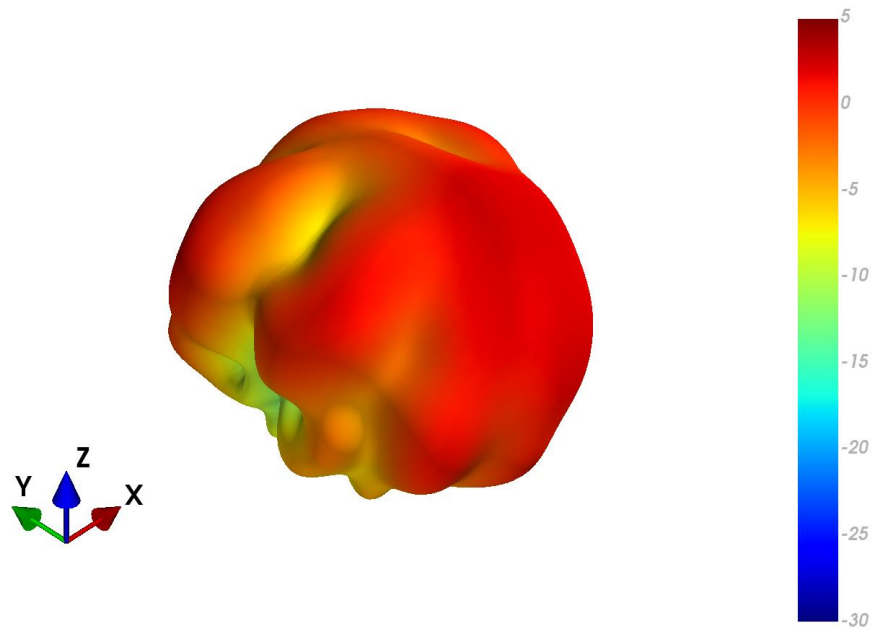

4.38 MIMO1 LTE Ground Plane Patterns at 4150 MHz

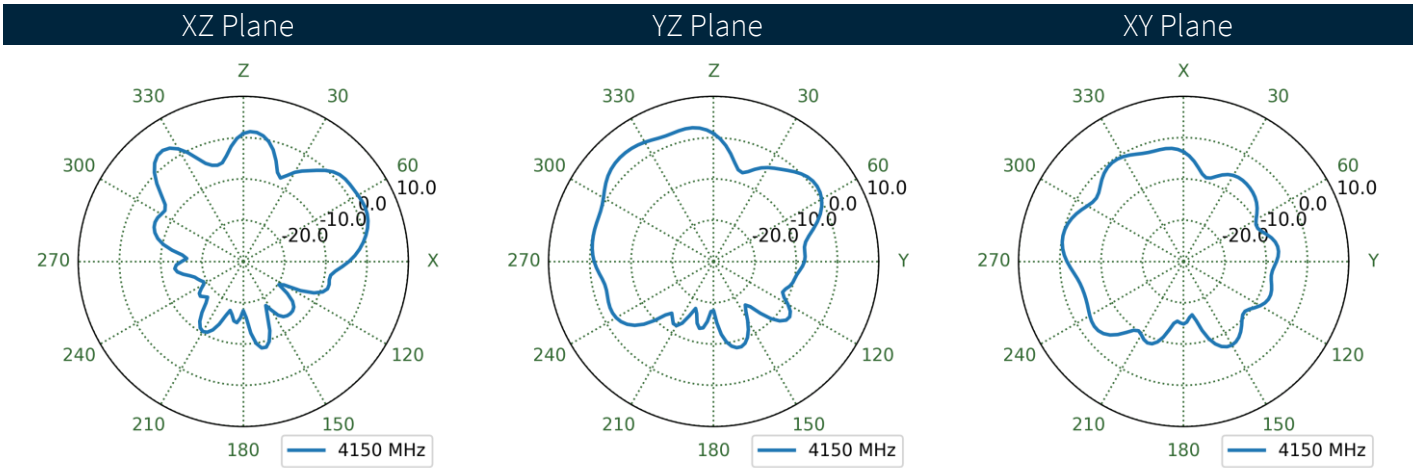
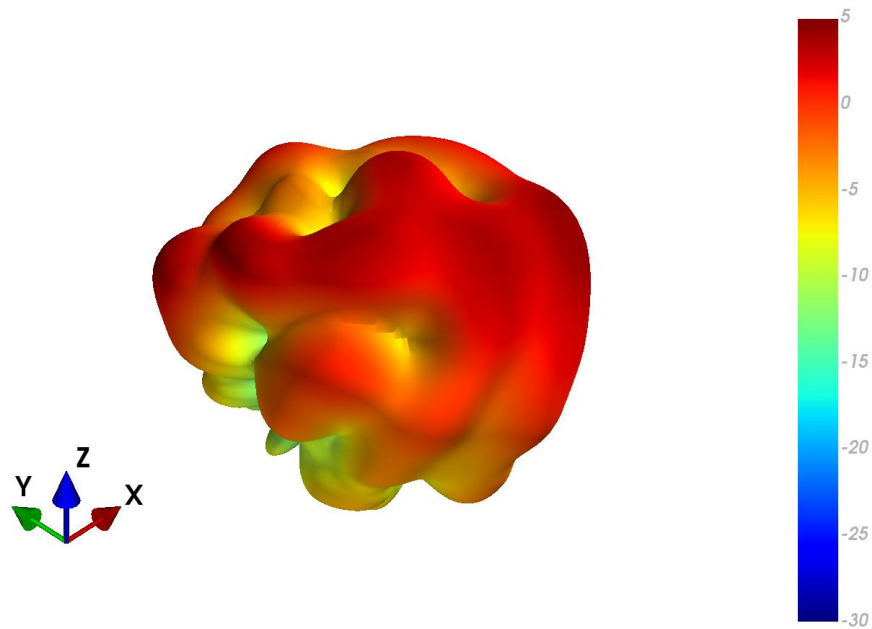

4.39 MIMO2 LTE Free Space Patterns at 4150 MHz

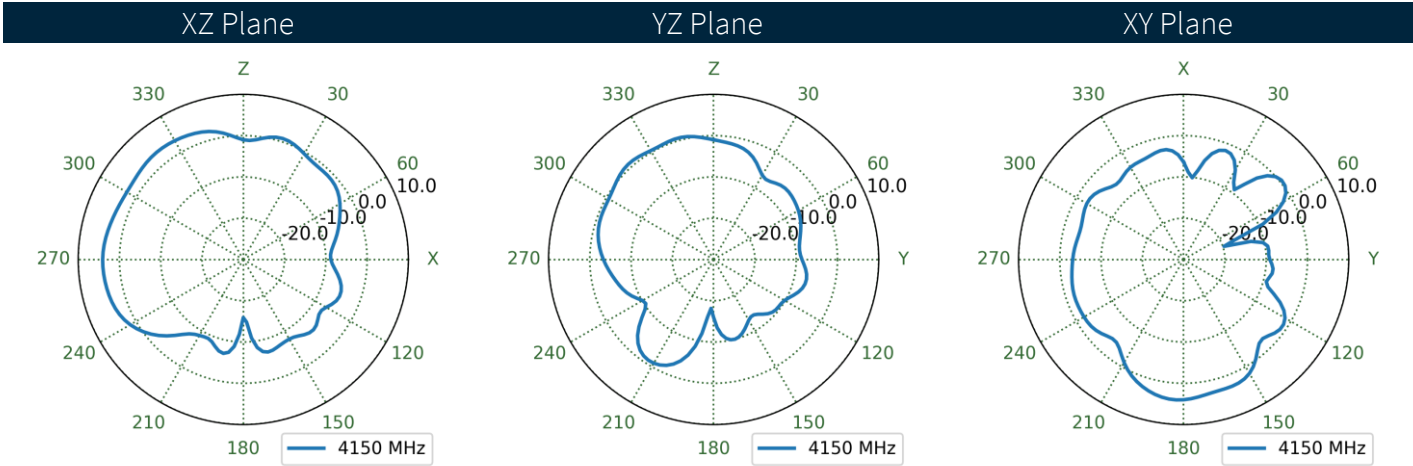
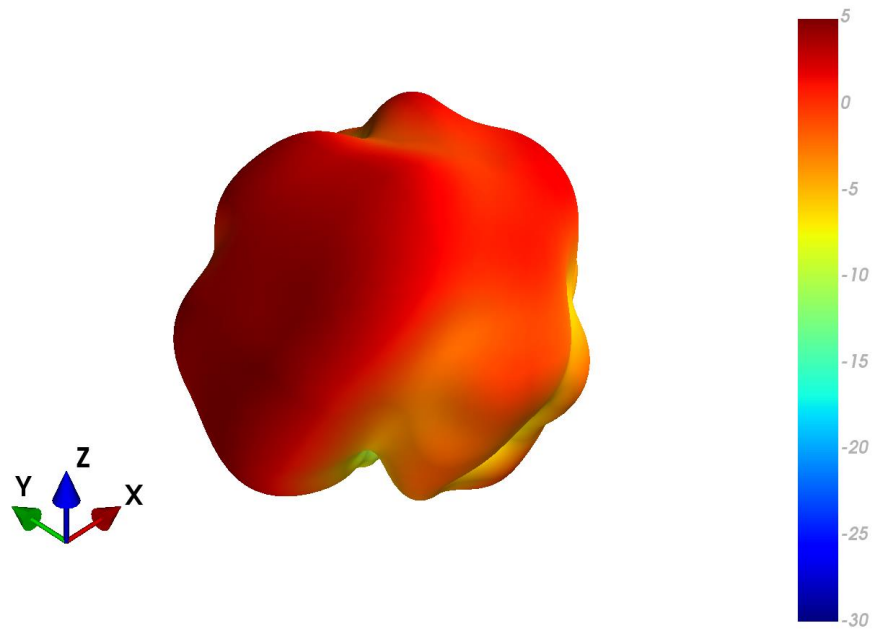

4.40 MIMO2 LTE Ground Plane Patterns at 4150 MHz

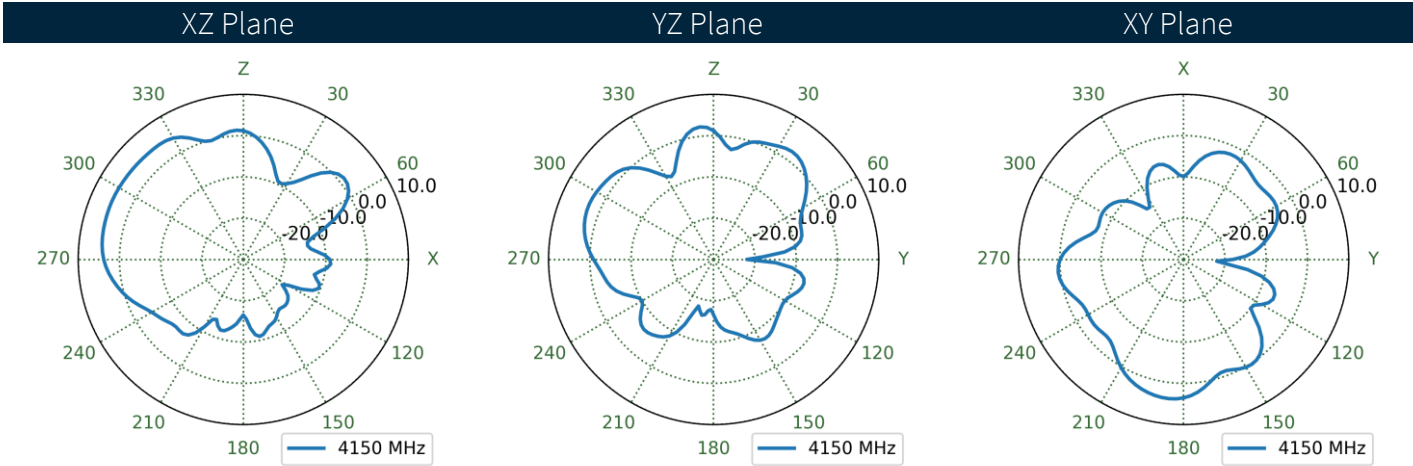
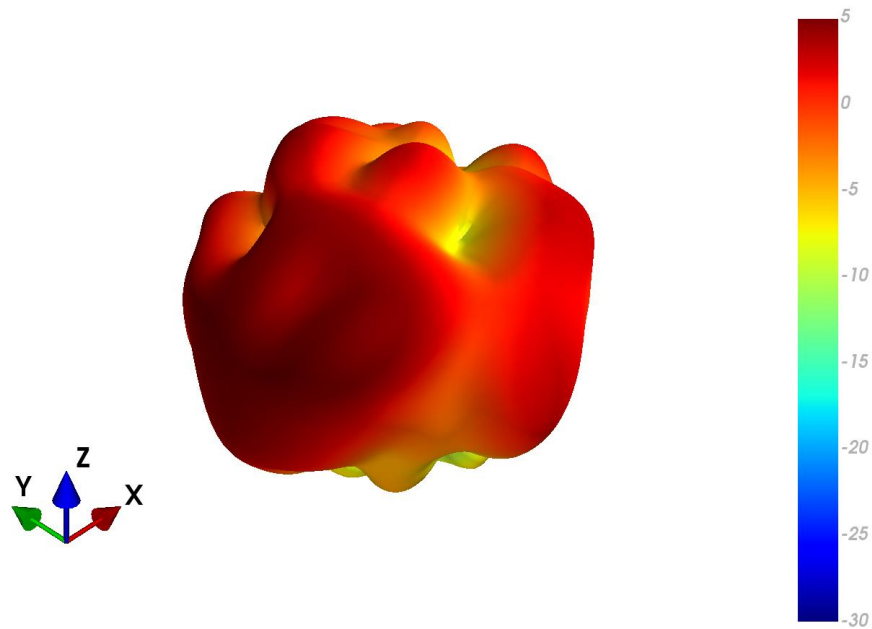

4.41 MIMO1 LTE Free Space Patterns at 5538 MHz

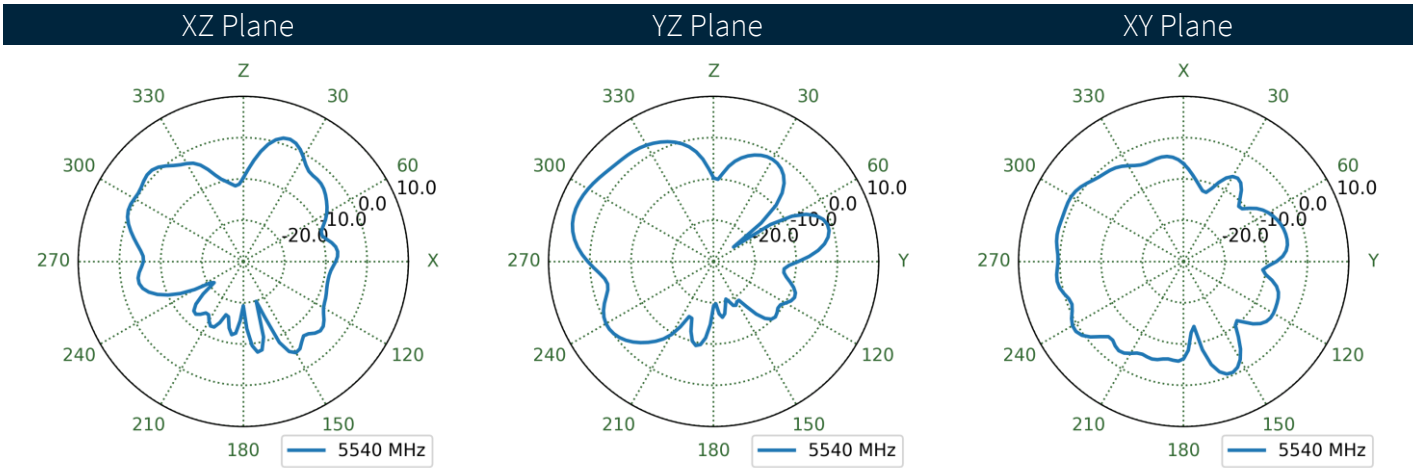
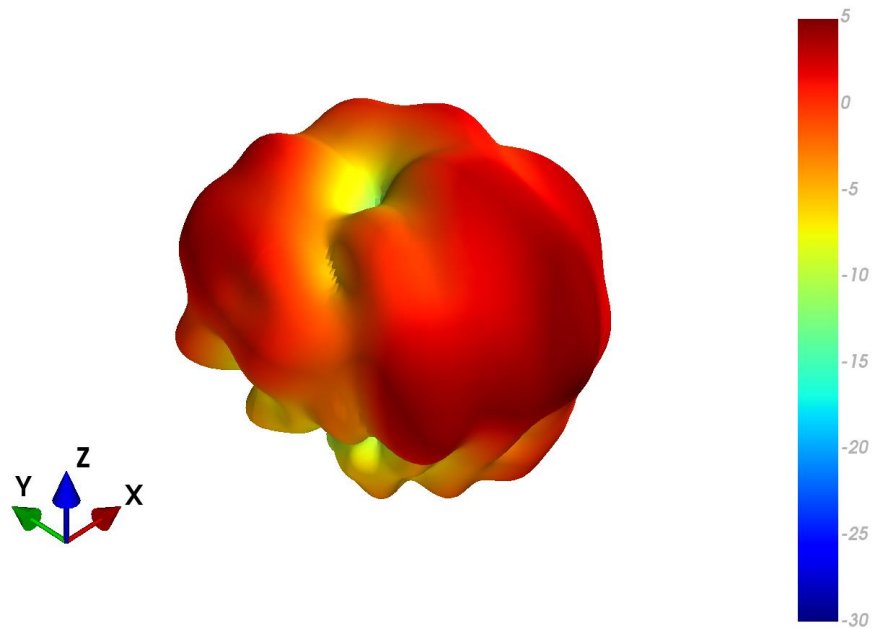

4.42 MIMO1 LTE Ground Plane Patterns at 5538 MHz

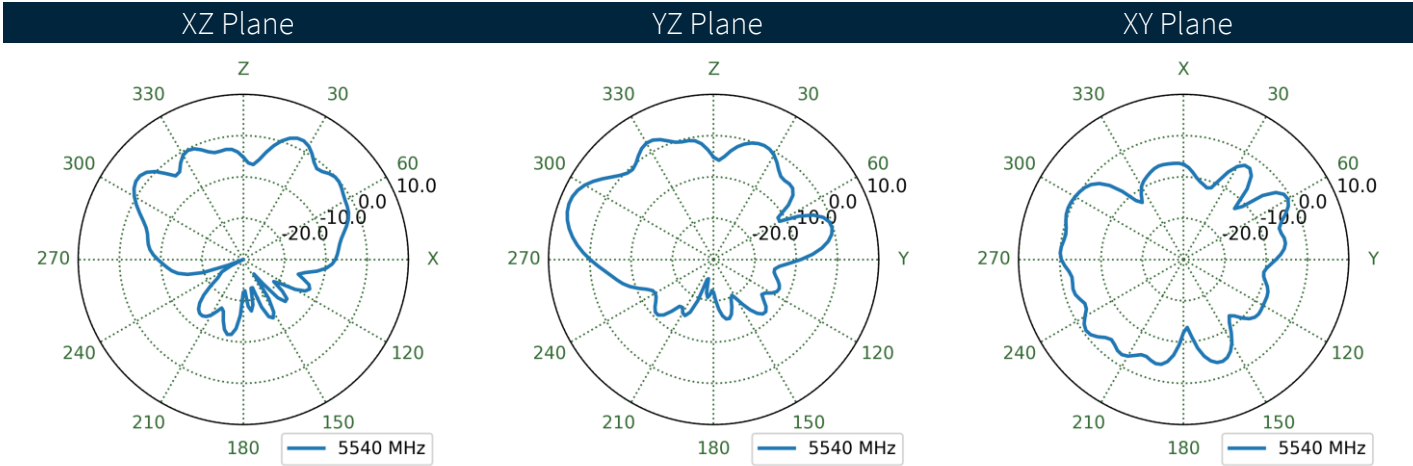
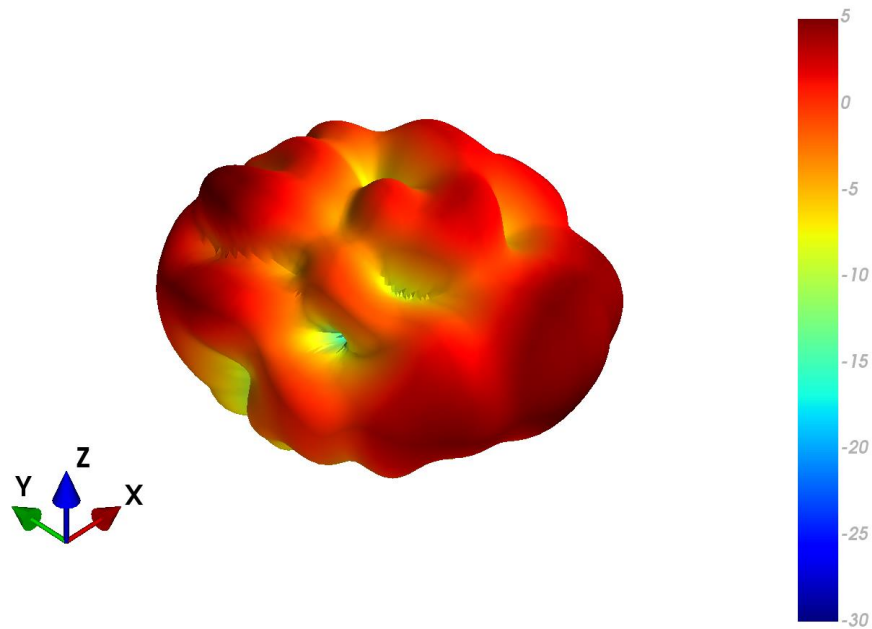

4.43 MIMO2 LTE Free Space Patterns at 5538 MHz

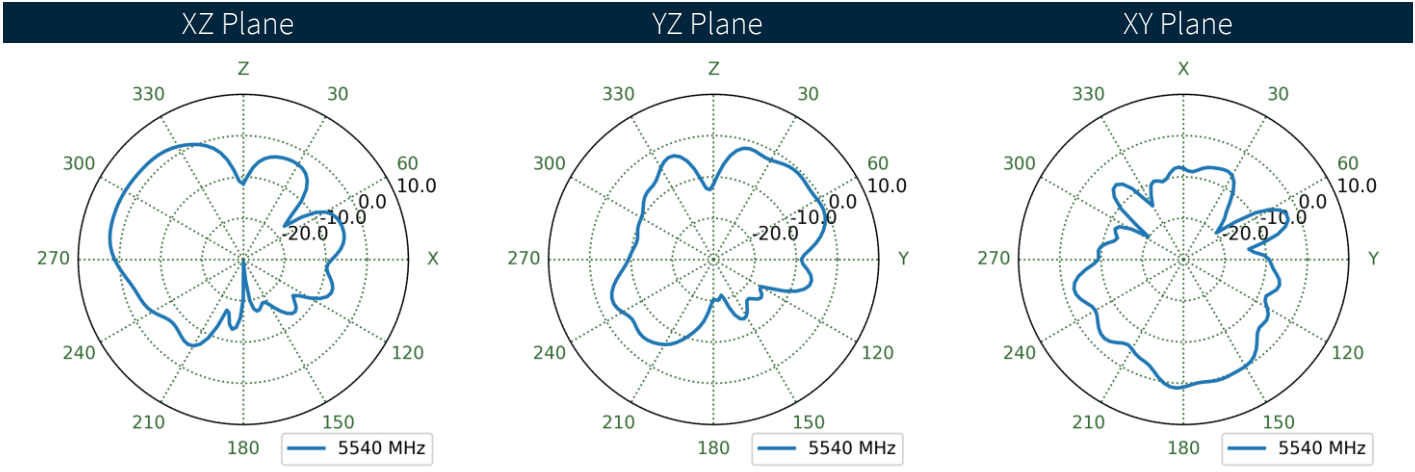
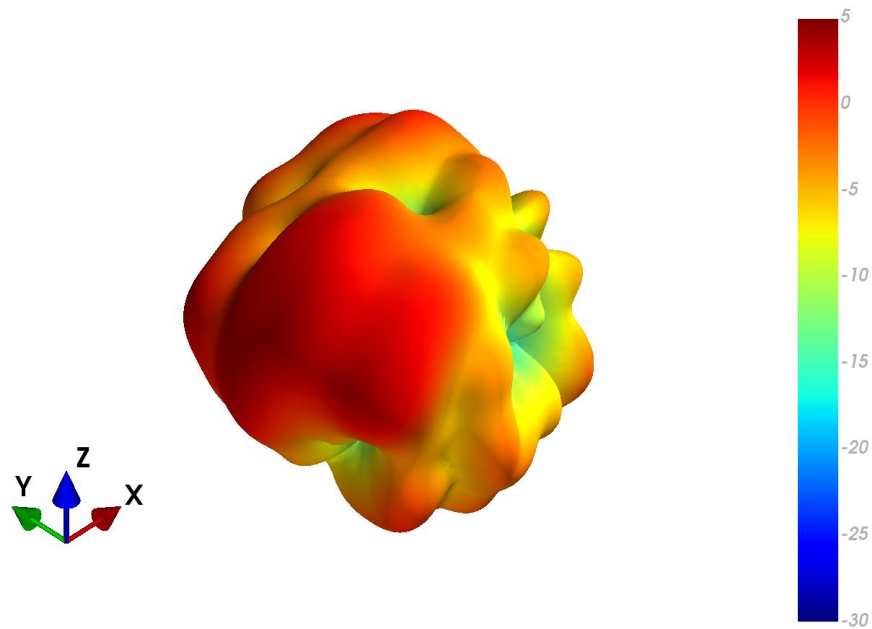

4.44 MIMO2 LTE Ground Plane Patterns at 5538 MHz

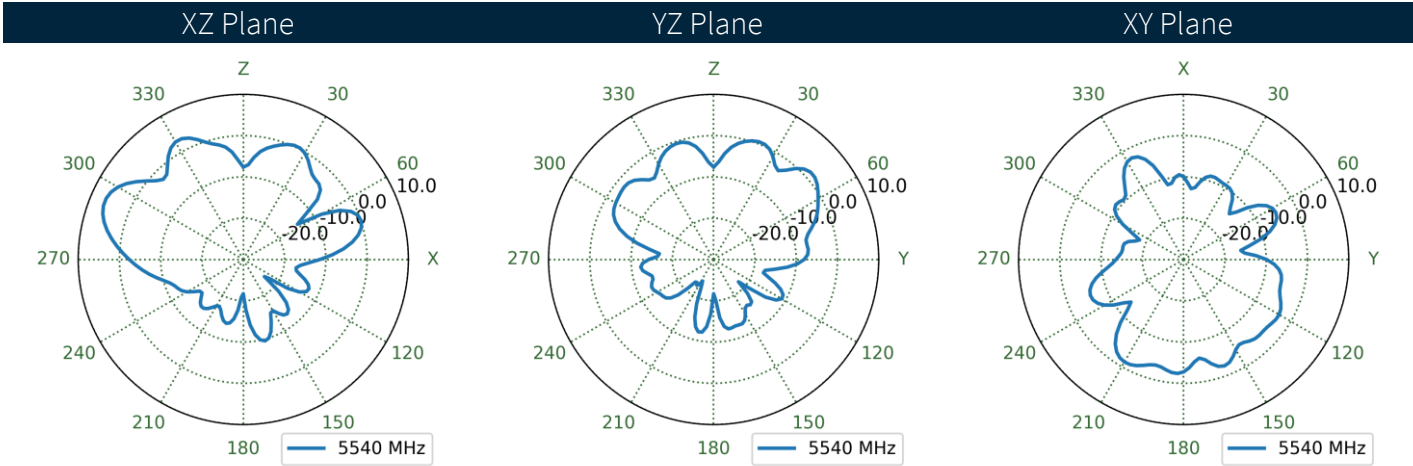
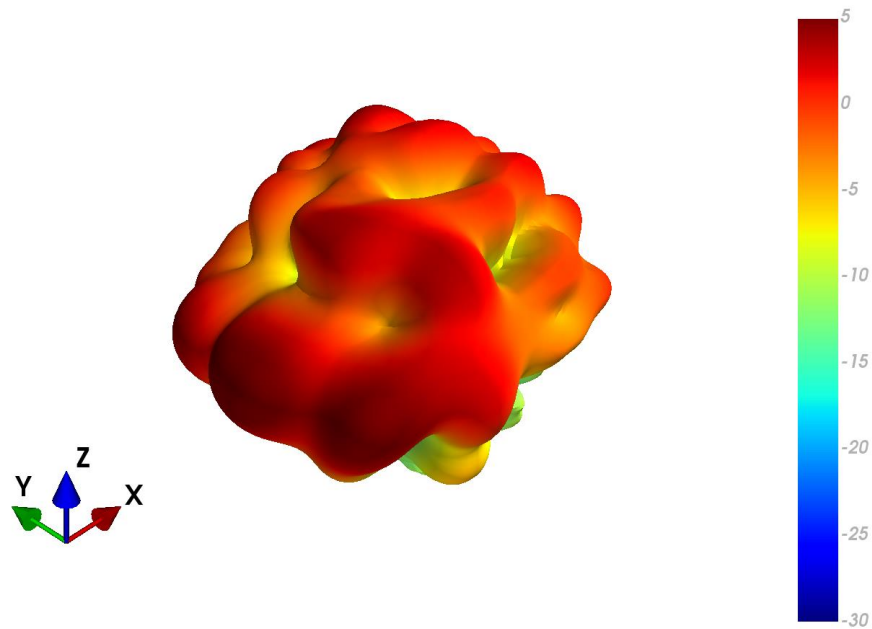

4.45 MIMO1 Wi-Fi Free Space Patterns at 2400 MHz

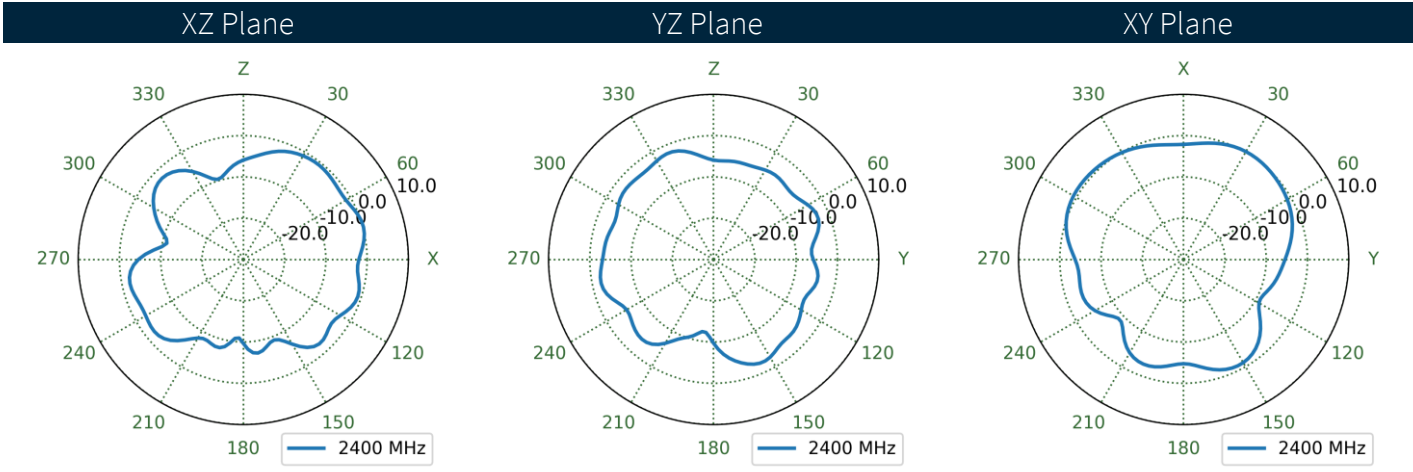
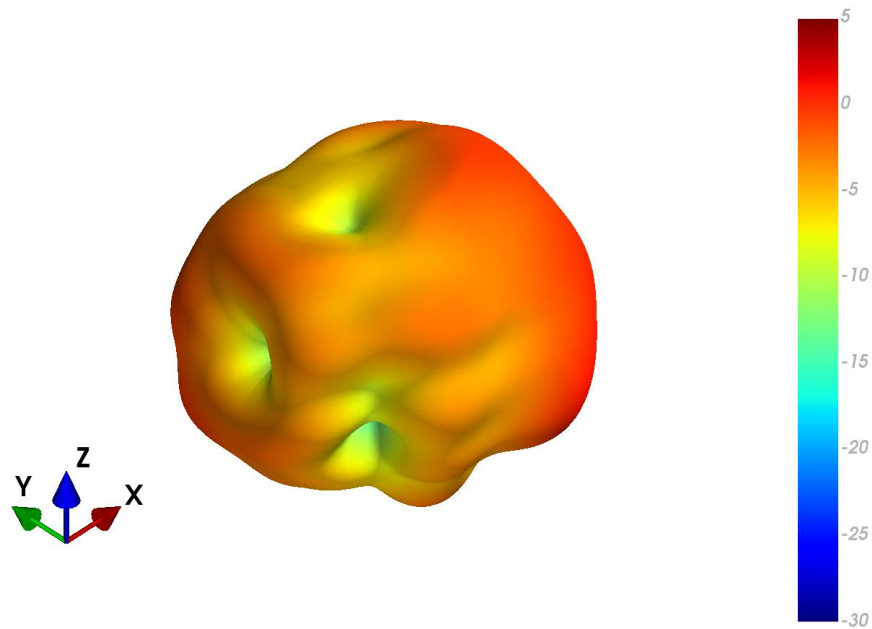

4.46 MIMO1 Wi-Fi Ground Plane Patterns at 2400 MHz

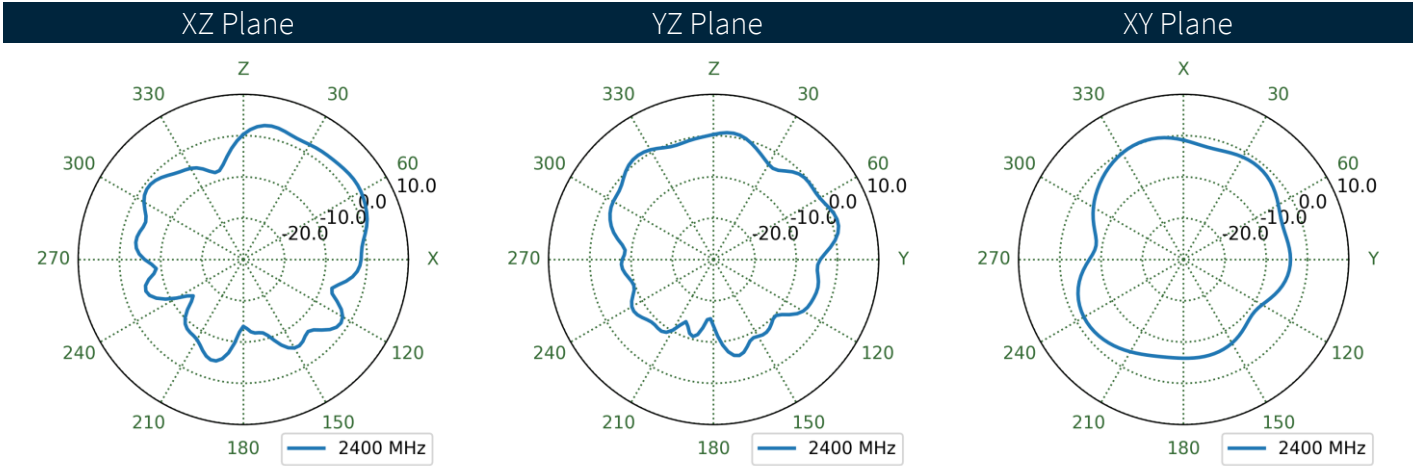
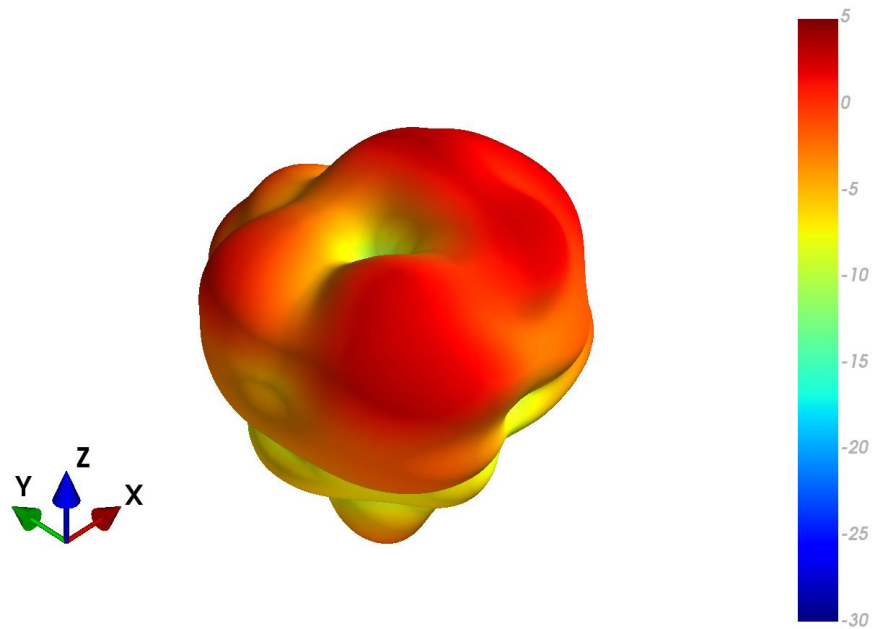

4.47 MIMO2 Wi-Fi Free Space Patterns at 2400 MHz

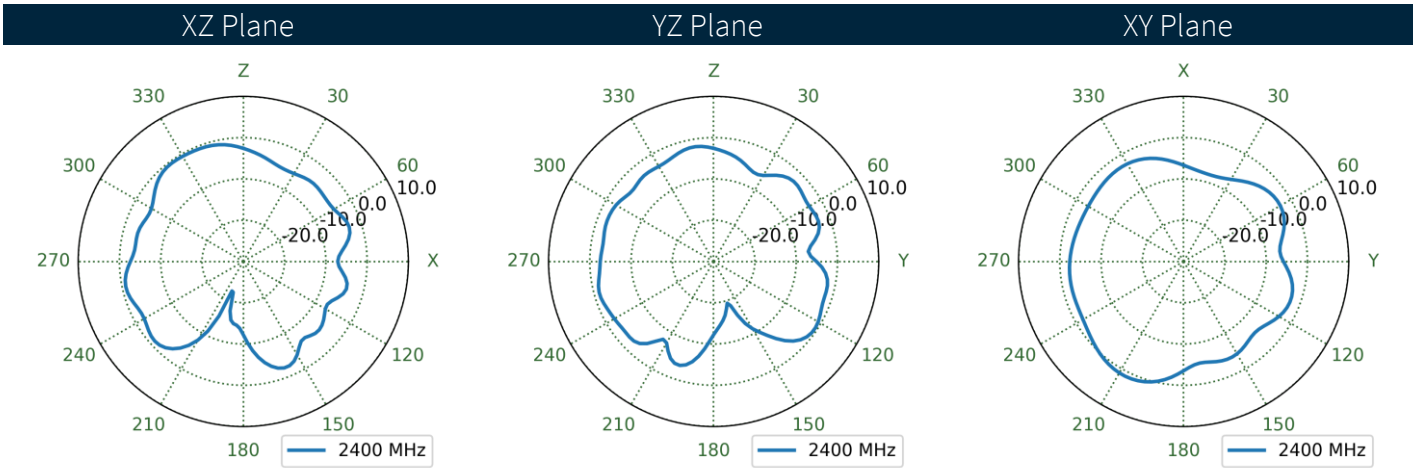
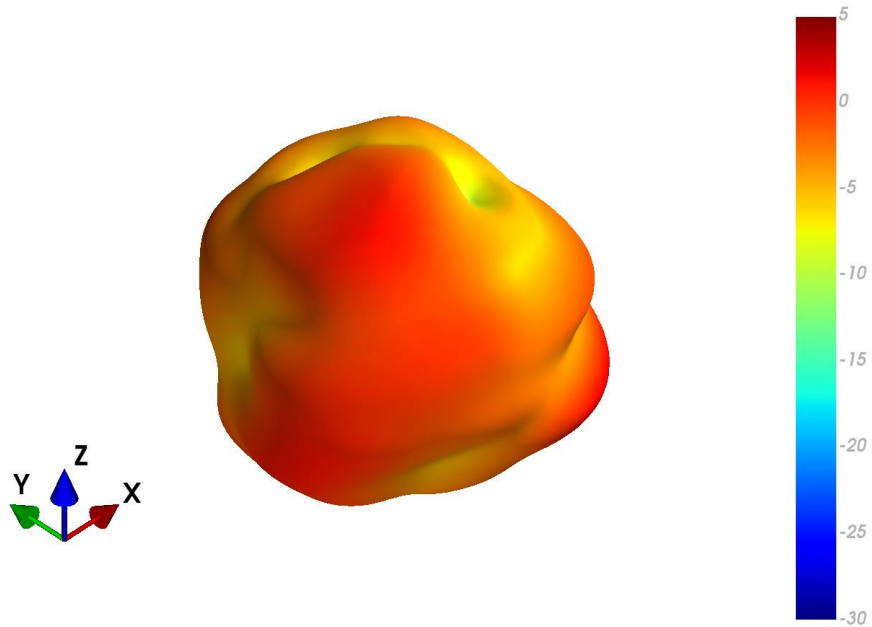

4.48 MIMO2 Wi-Fi Ground Plane Patterns at 2400 MHz

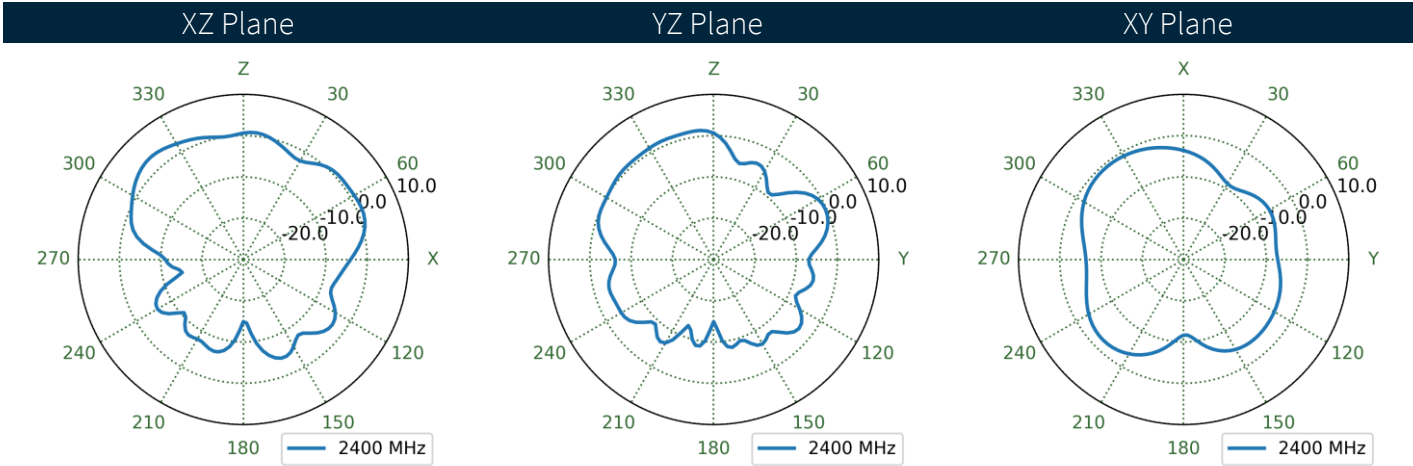
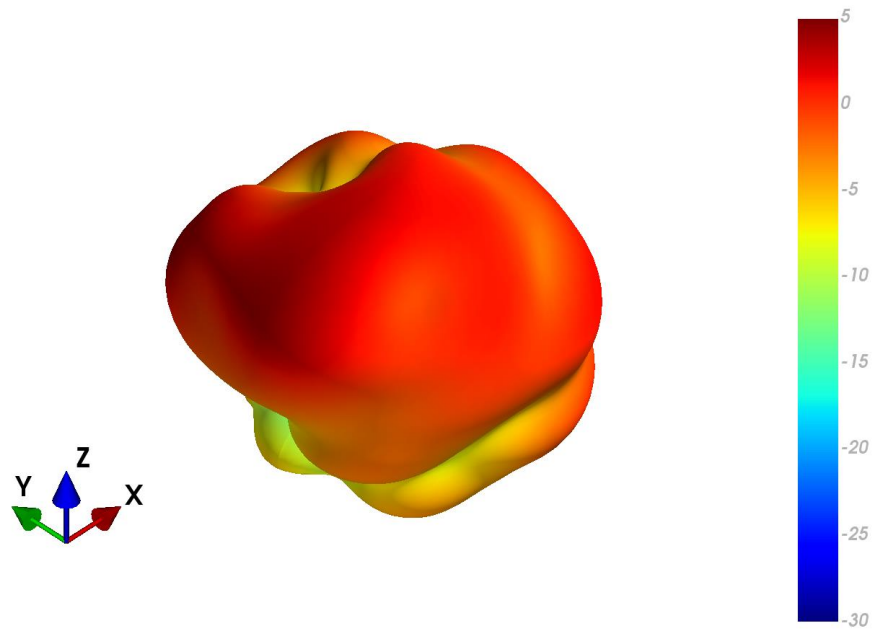

4.49 MIMO1 Wi-Fi Free Space Patterns at 2450 MHz

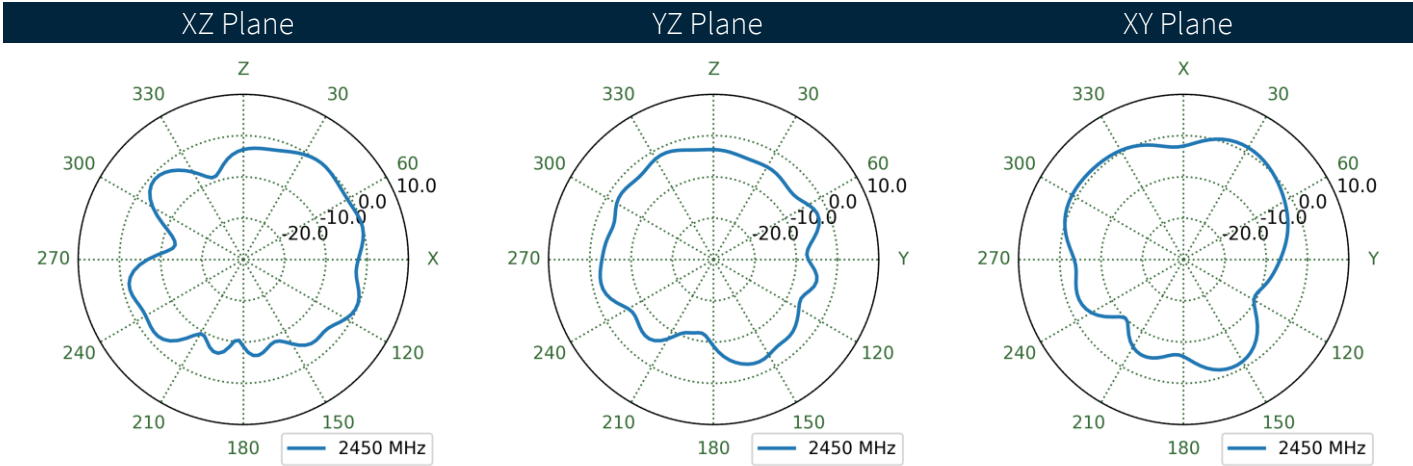
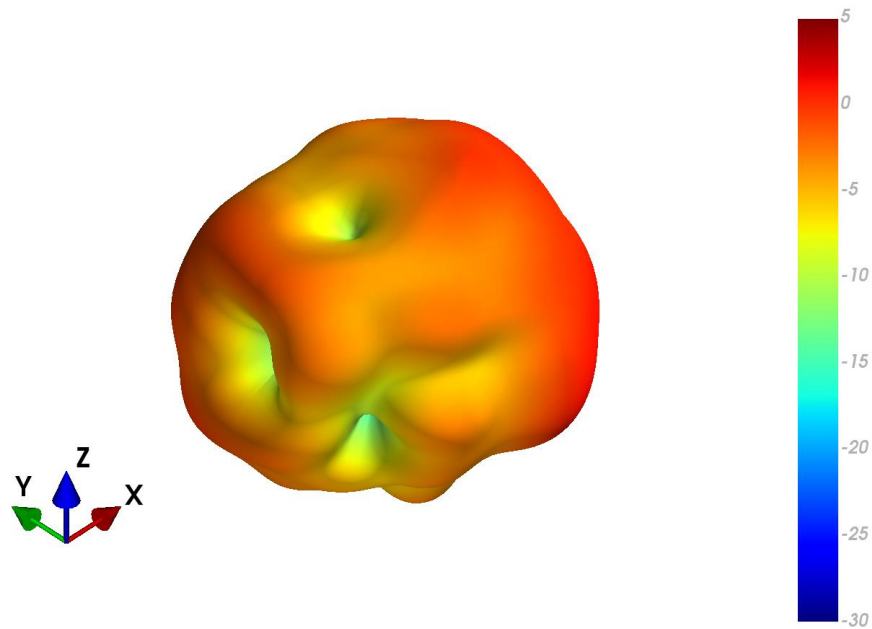

4.50 MIMO1 Wi-Fi Ground Plane Patterns at 2450 MHz

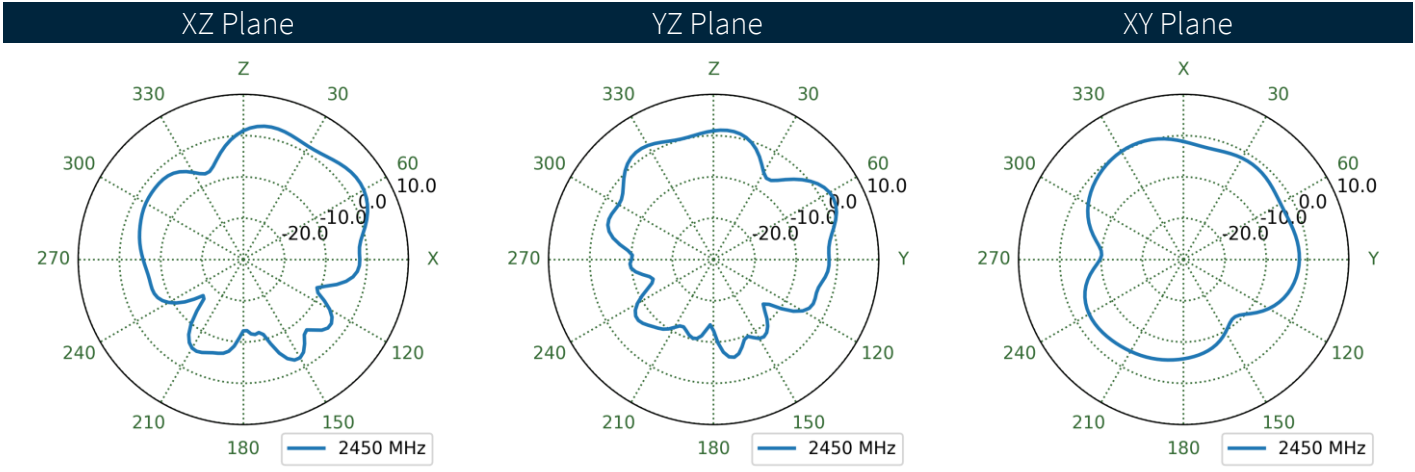
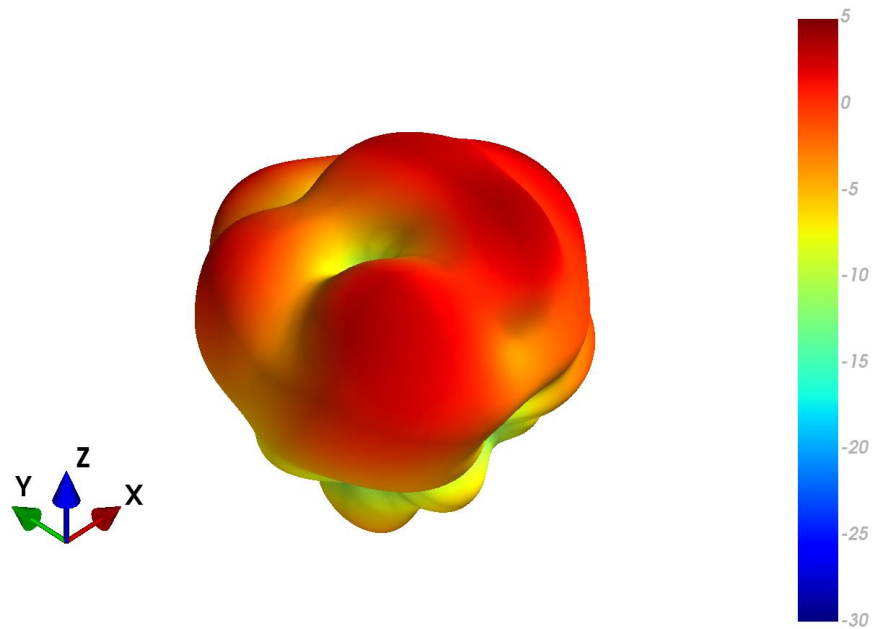

4.51 MIMO2 Wi-Fi Free Space Patterns at 2450 MHz

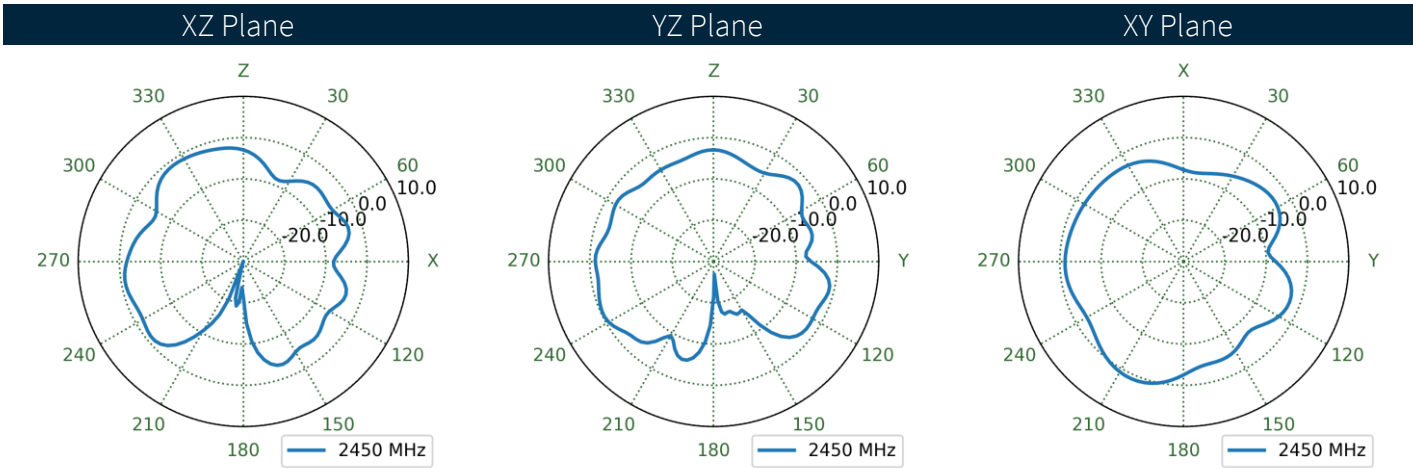
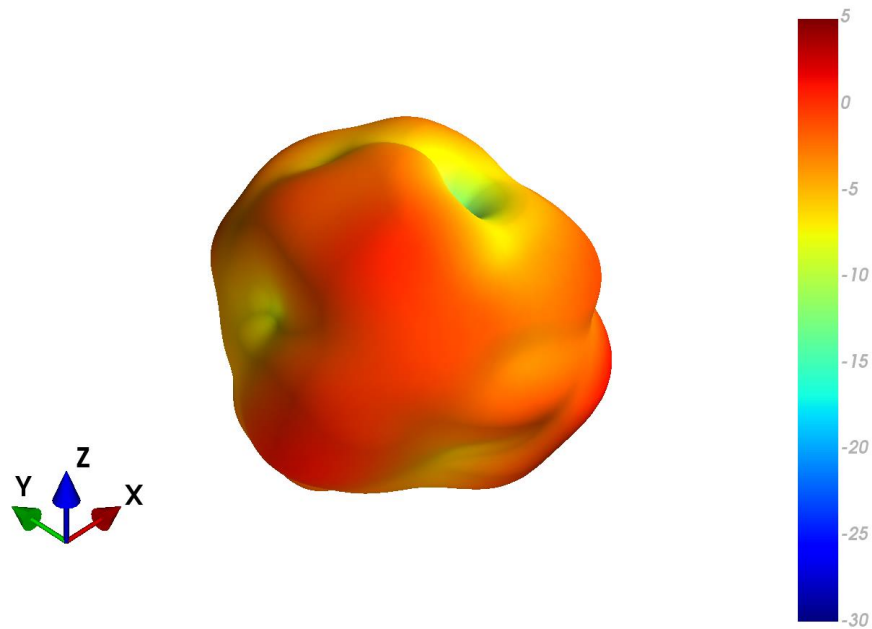

4.52 MIMO2 Wi-Fi Ground Plane Patterns at 2450 MHz

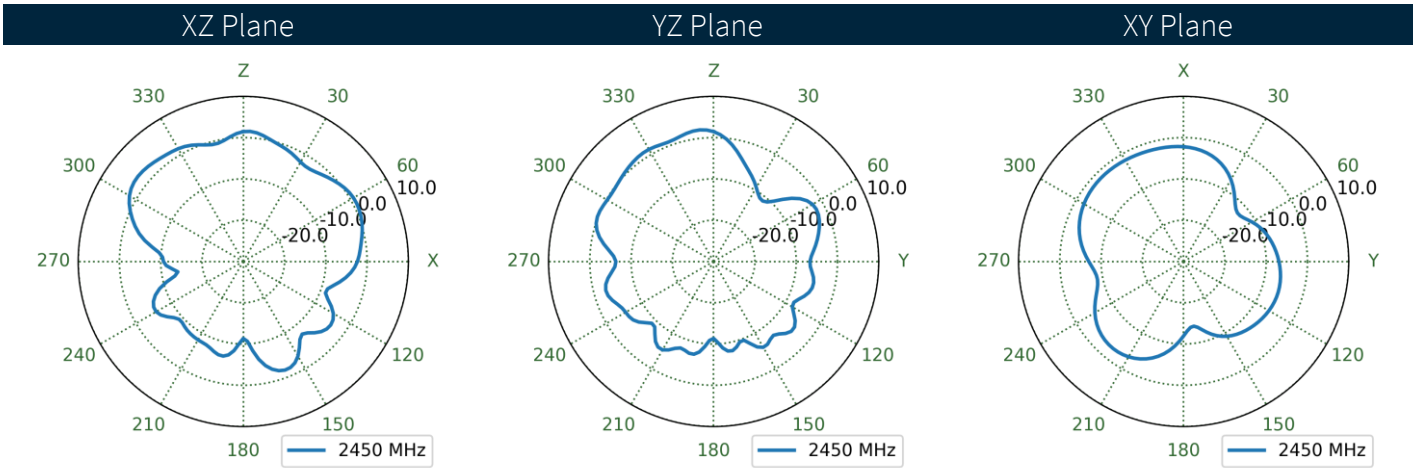
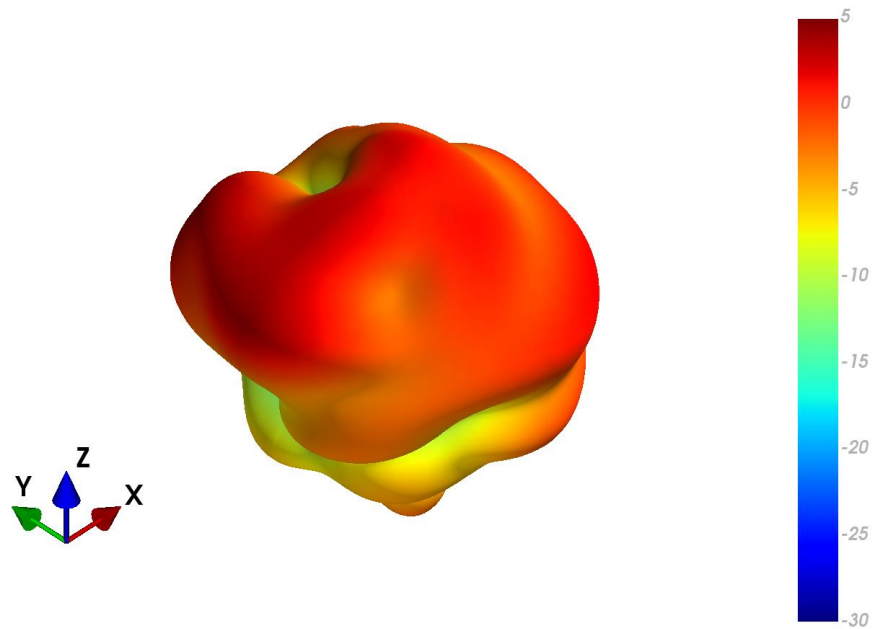

4.53 MIMO1 Wi-Fi Free Space Patterns at 2500 MHz

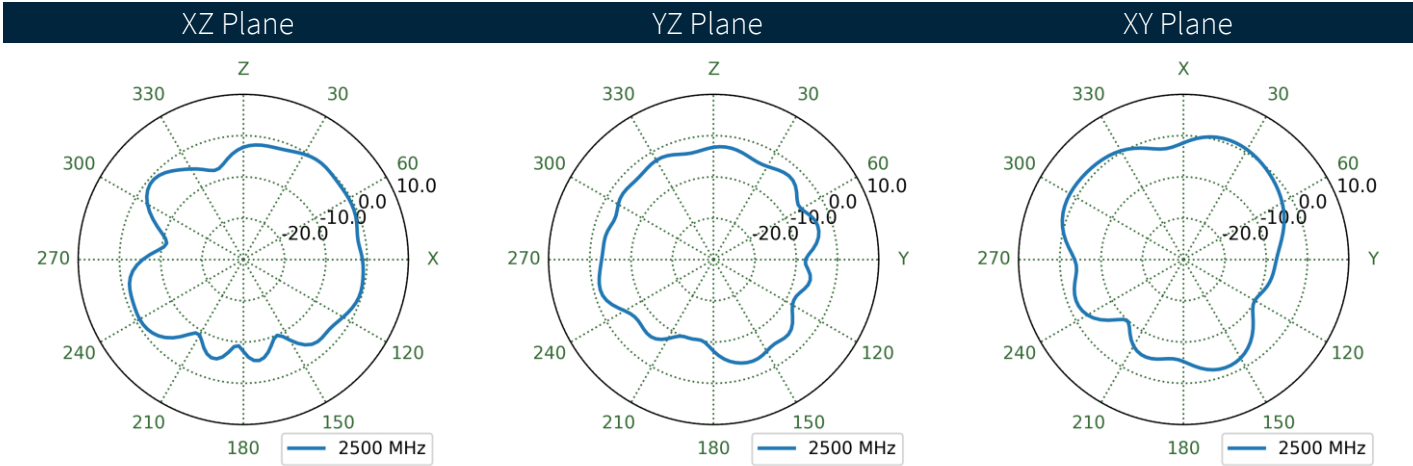
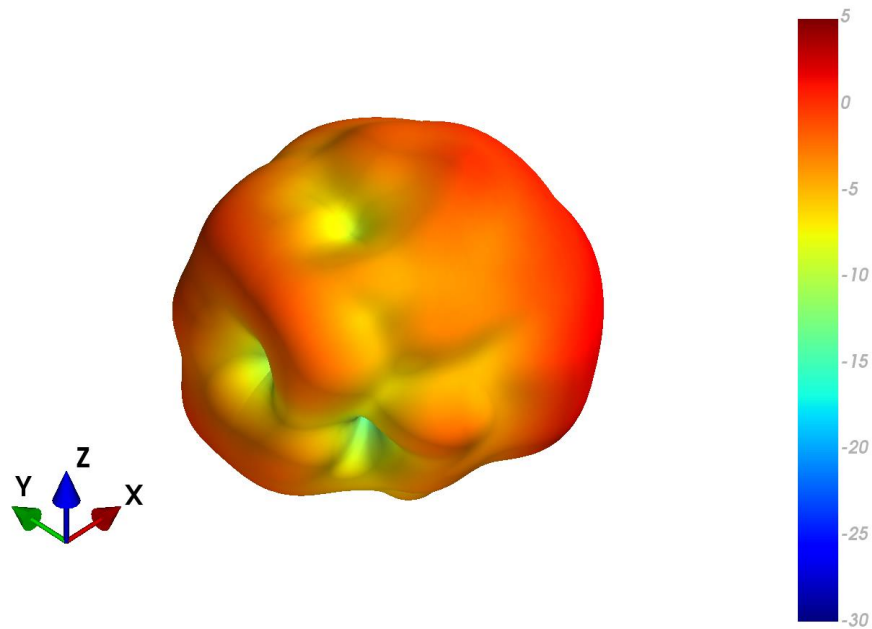

4.54 MIMO1 Wi-Fi Ground Plane Patterns at 2500 MHz

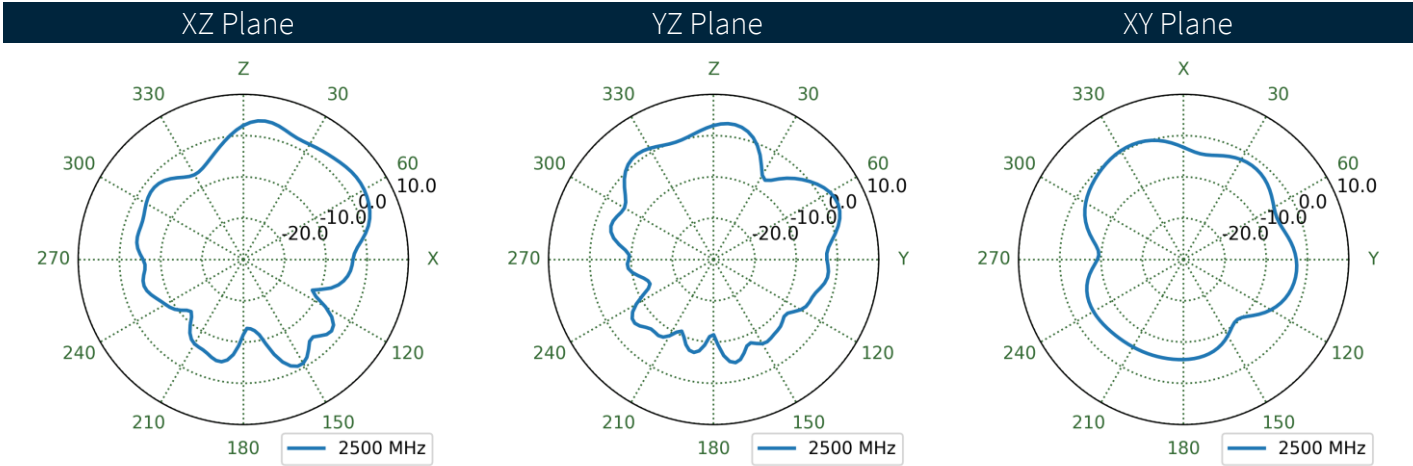
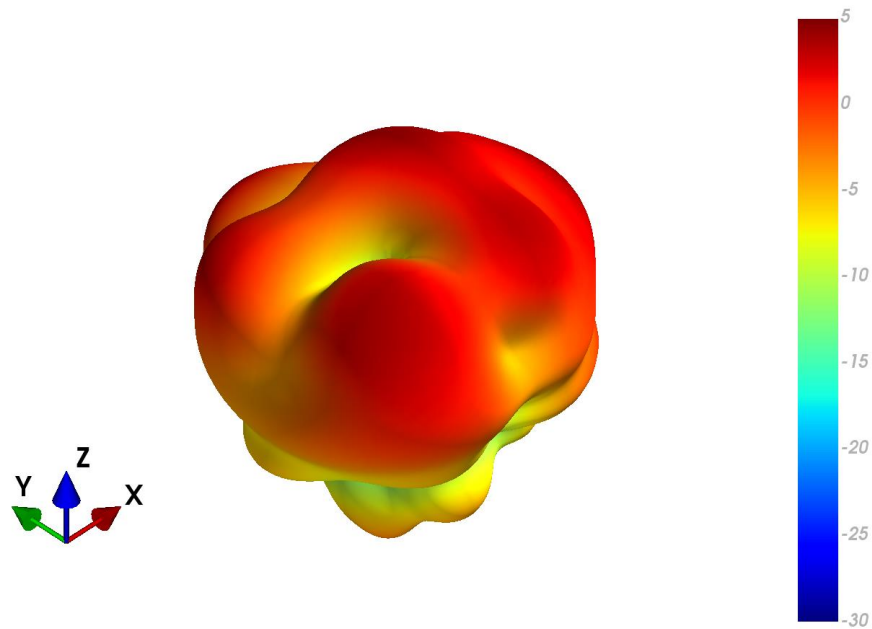

4.55 MIMO2 Wi-Fi Free Space Patterns at 2500 MHz

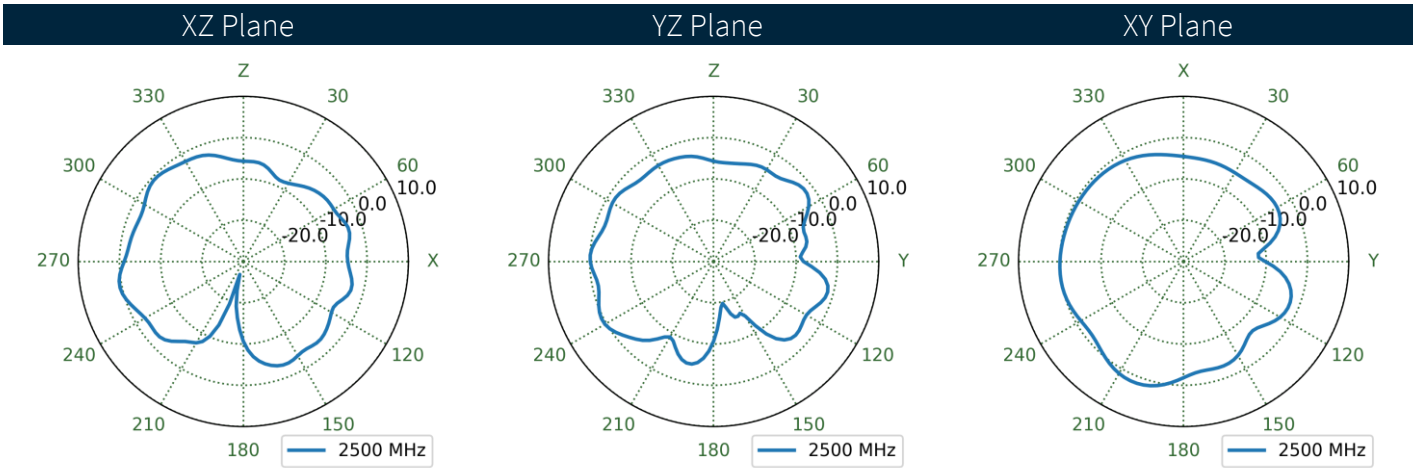
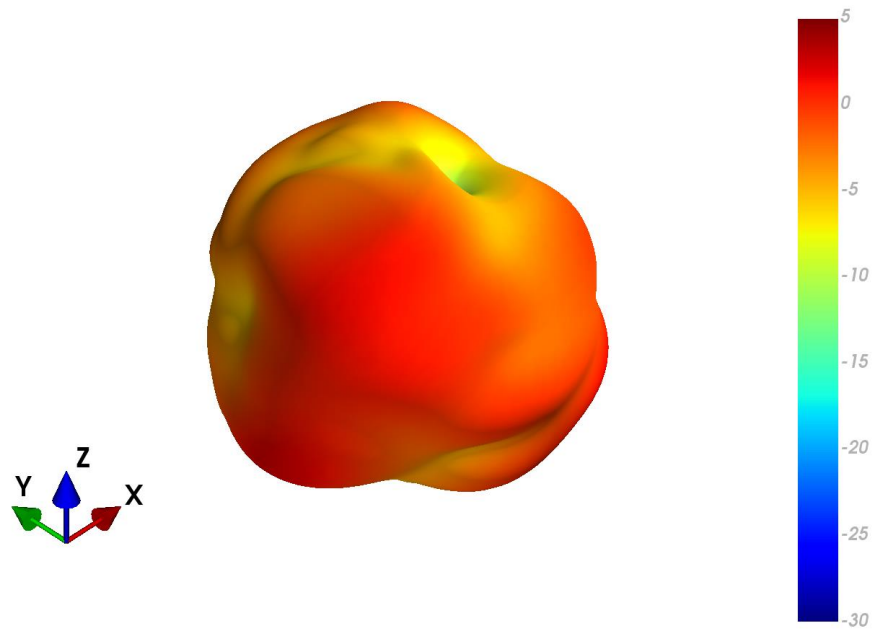

4.56 MIMO2 Wi-Fi Ground Plane Patterns at 2500 MHz

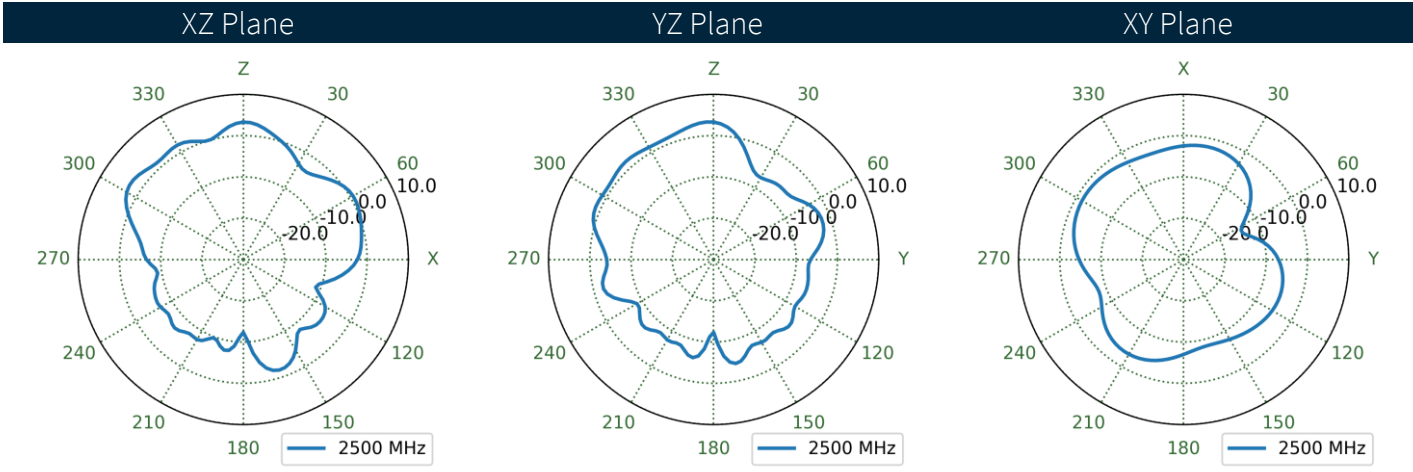
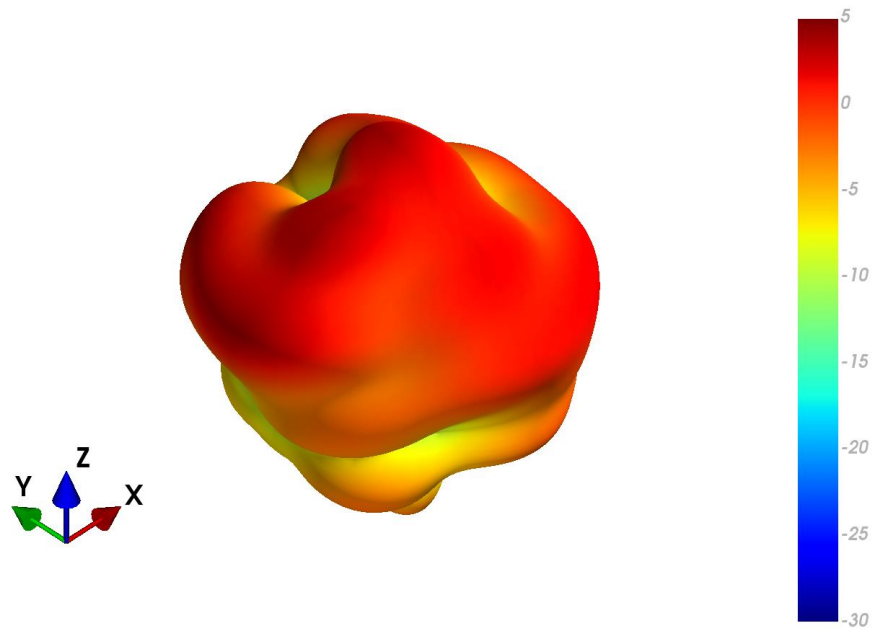

4.57 MIMO1 Wi-Fi Free Space Patterns at 5150 MHz

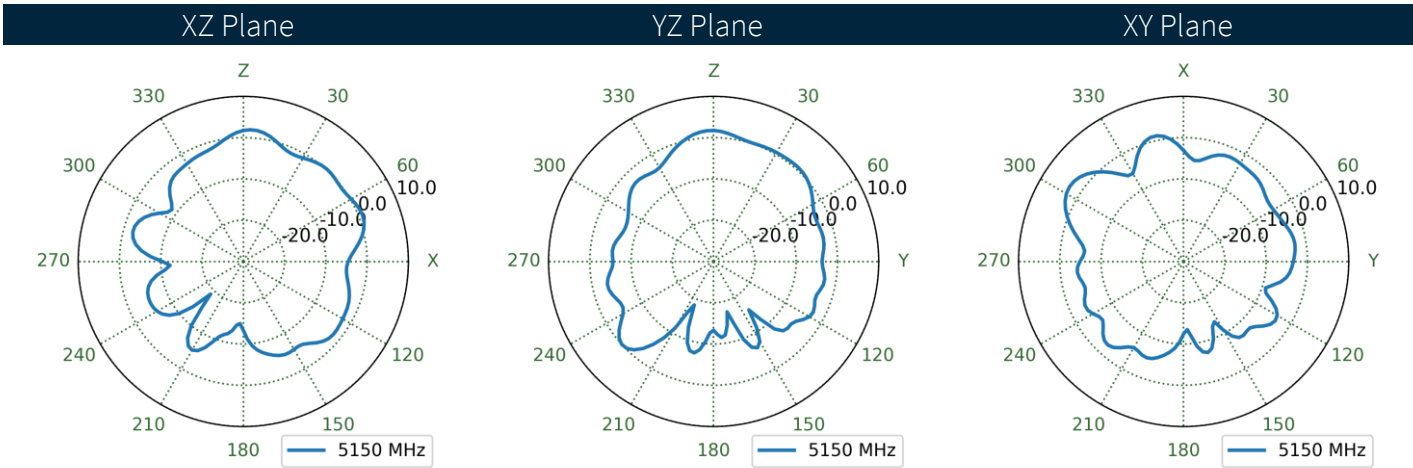
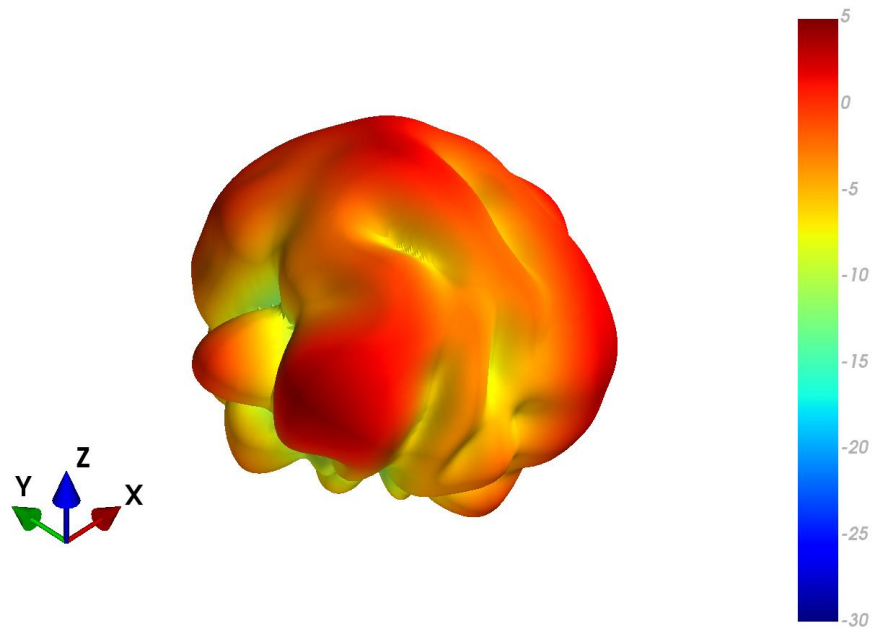

4.58 MIMO1 Wi-Fi Ground Plane Patterns at 5150 MHz

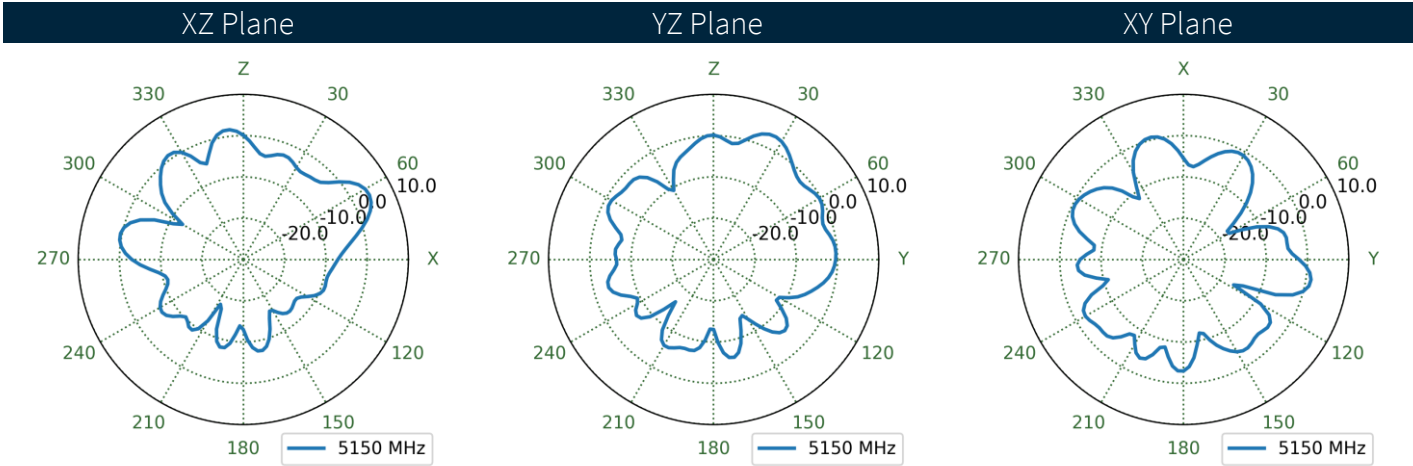
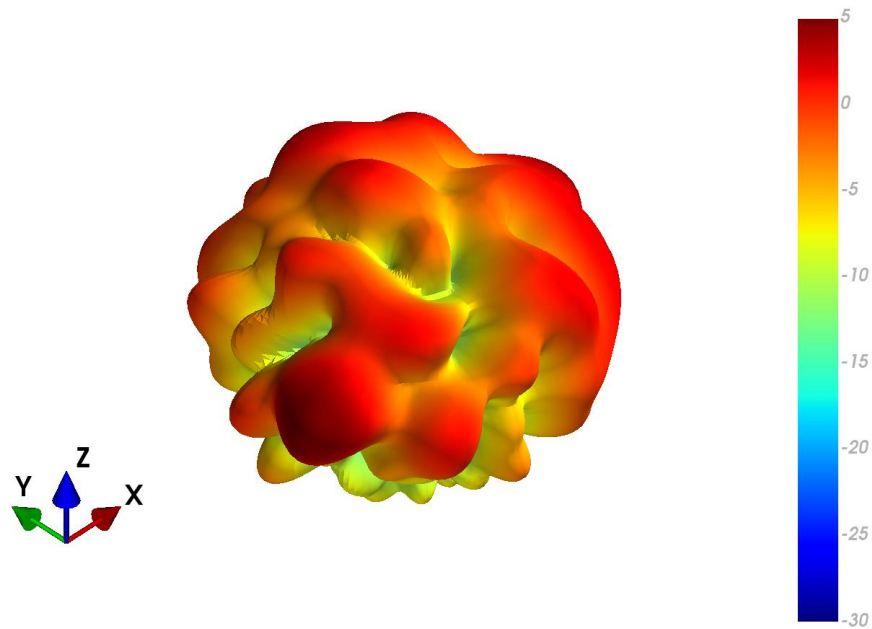

4.59 MIMO2 Wi-Fi Free Space Patterns at 5150 MHz

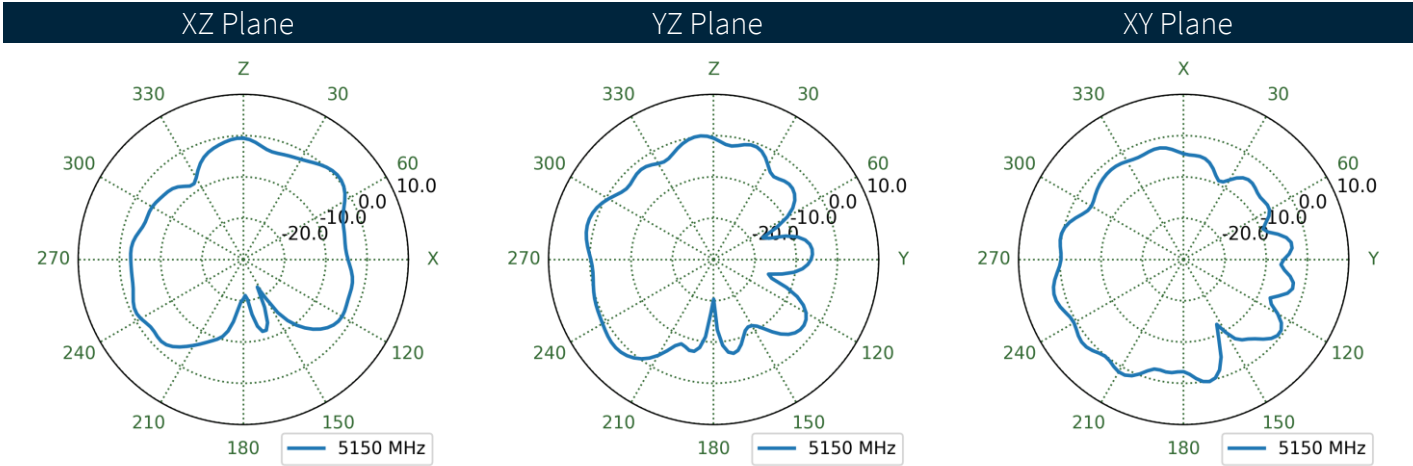
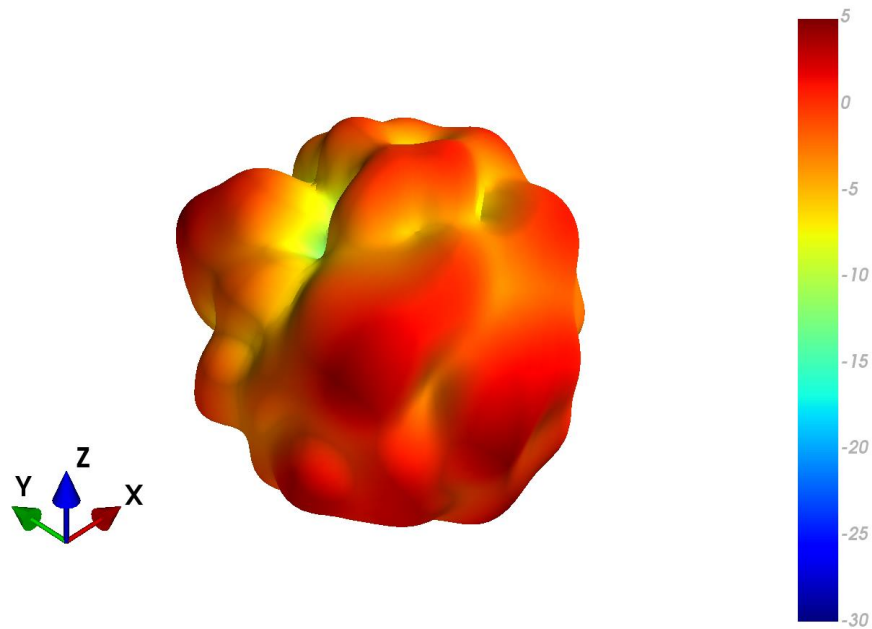

4.60 MIMO2 Wi-Fi Ground Plane Patterns at 5150 MHz

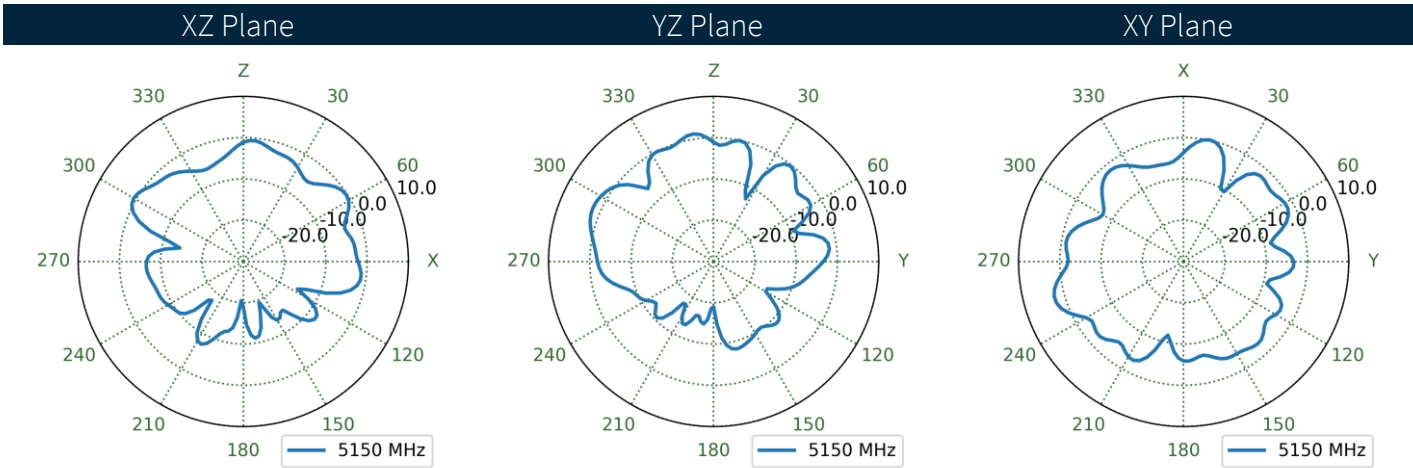
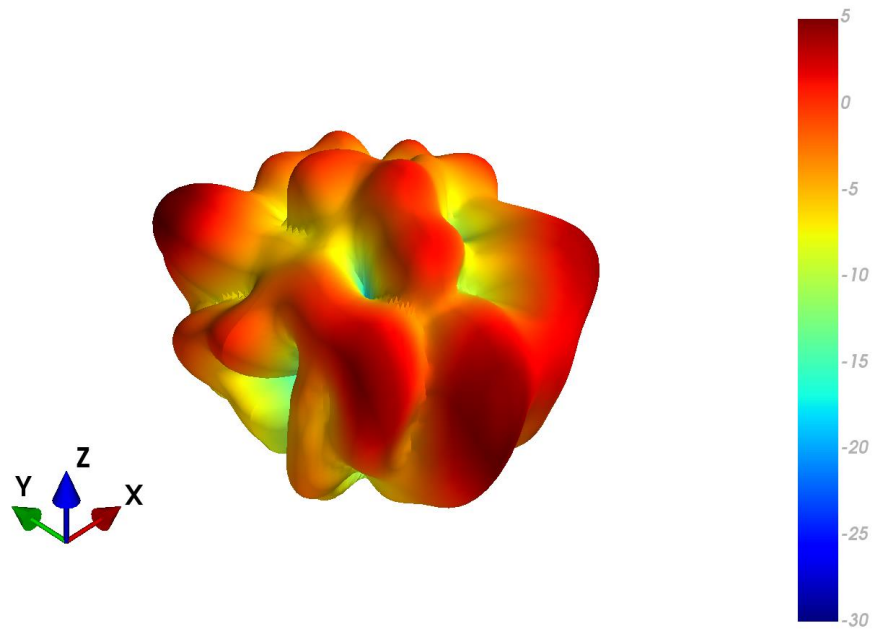

4.61 MIMO1 Wi-Fi Free Space Patterns at 5550 MHz

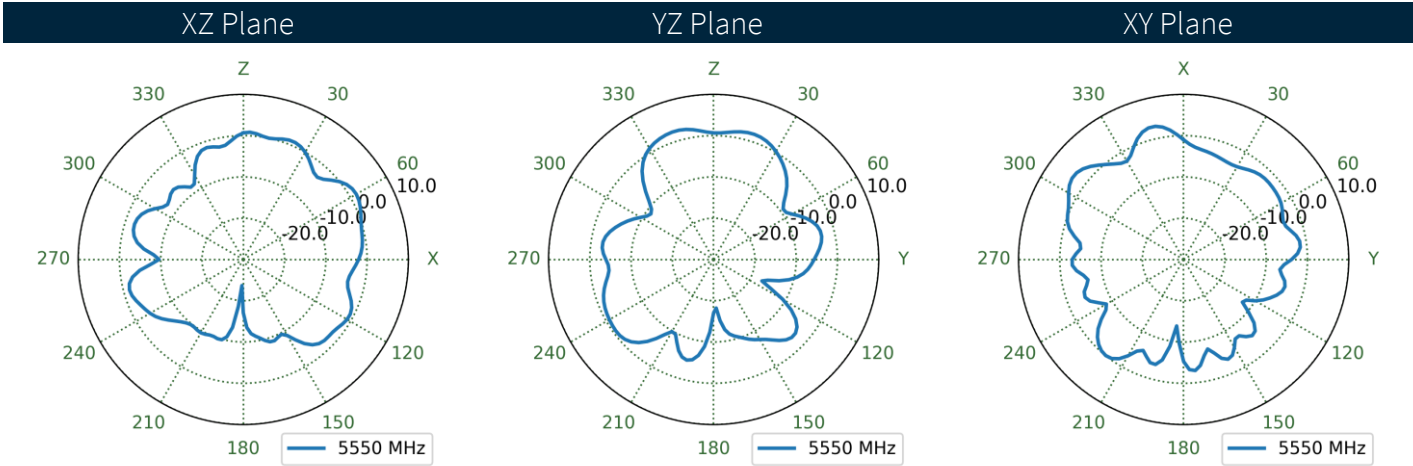
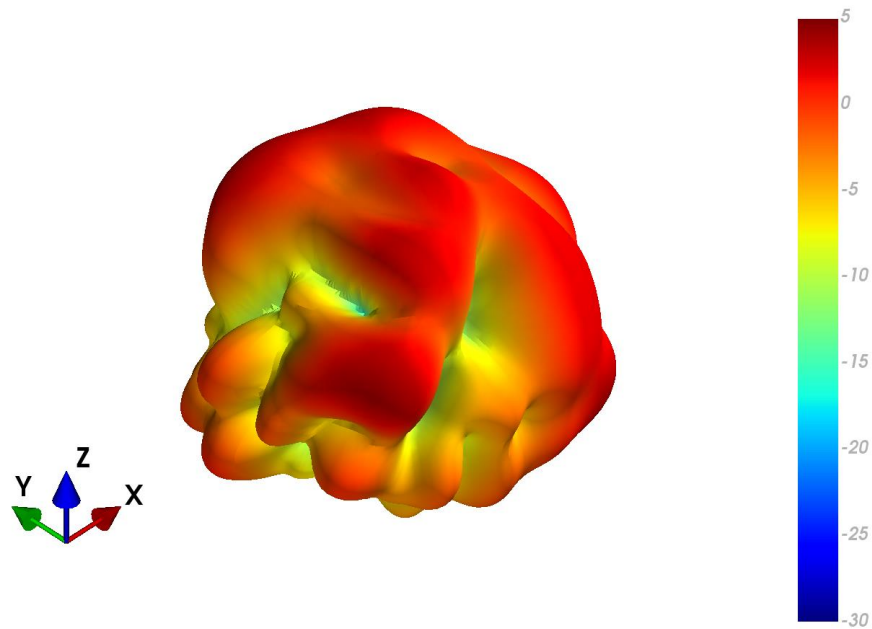

4.62 MIMO1 Wi-Fi Ground Plane Patterns at 5550 MHz

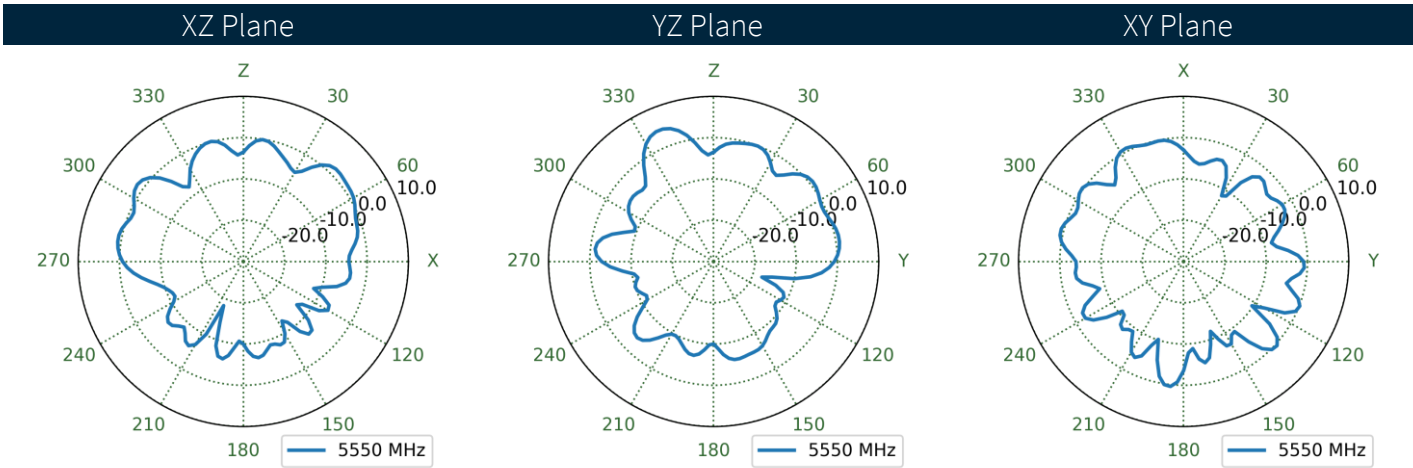
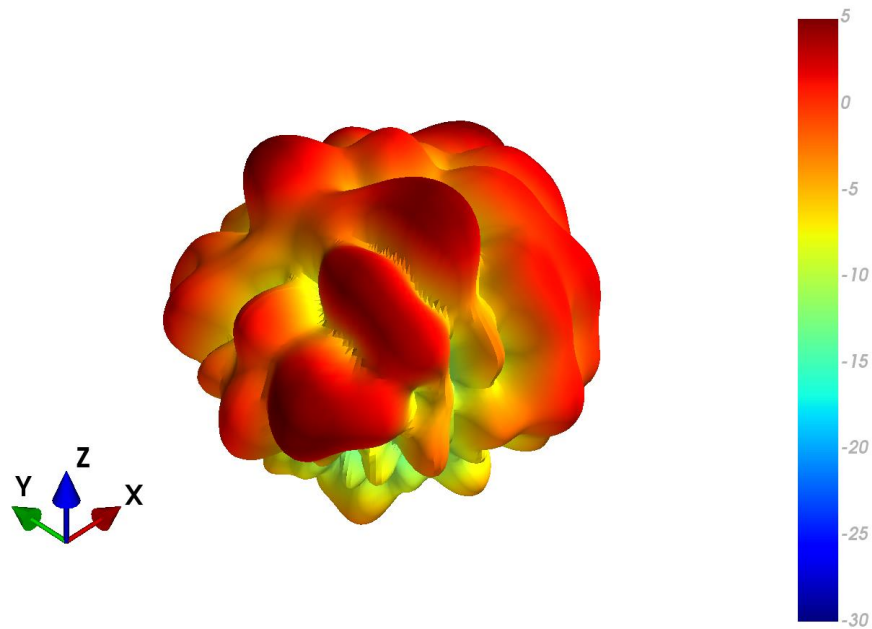

4.63 MIMO2 Wi-Fi Free Space Patterns at 5550 MHz

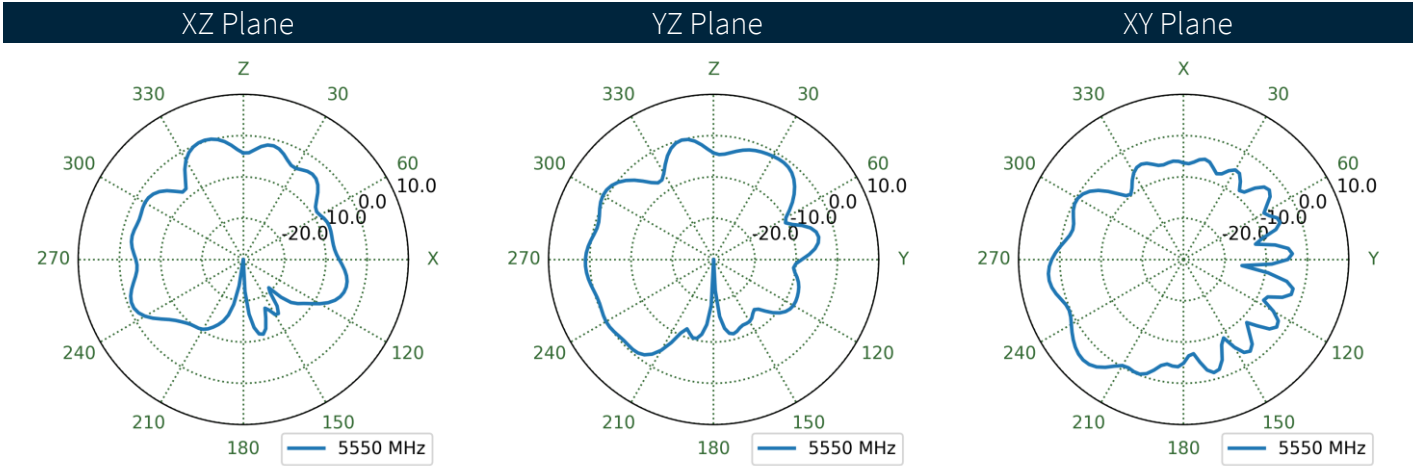
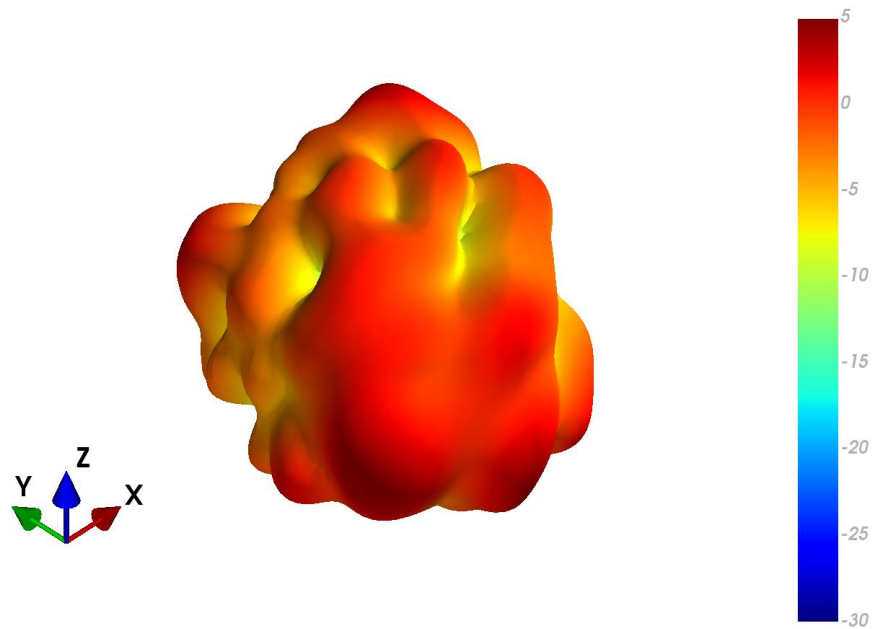

4.64 MIMO2 Wi-Fi Ground Plane Patterns at 5550 MHz

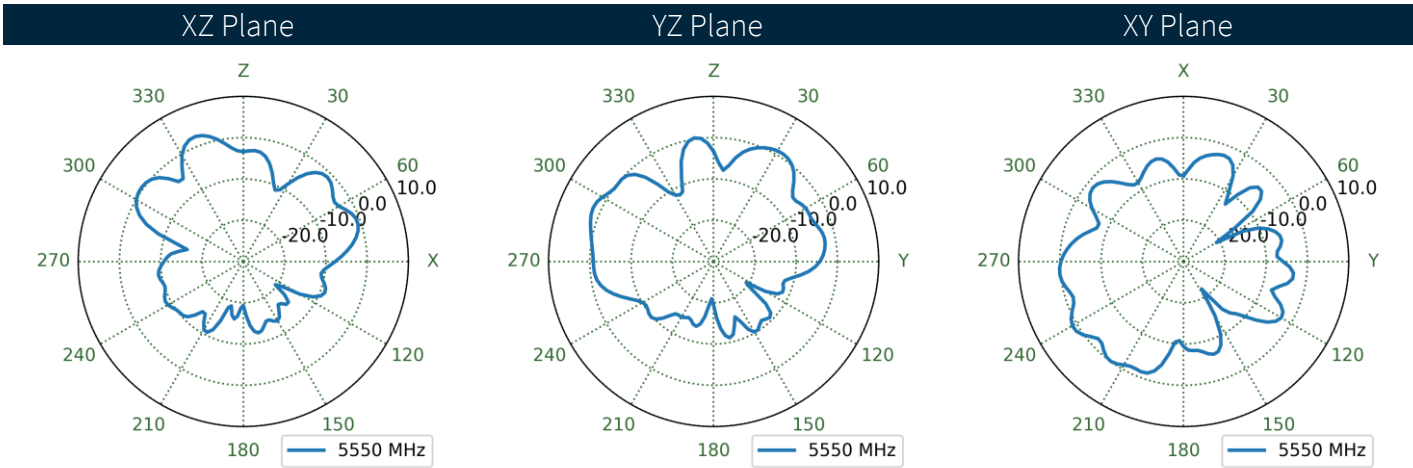
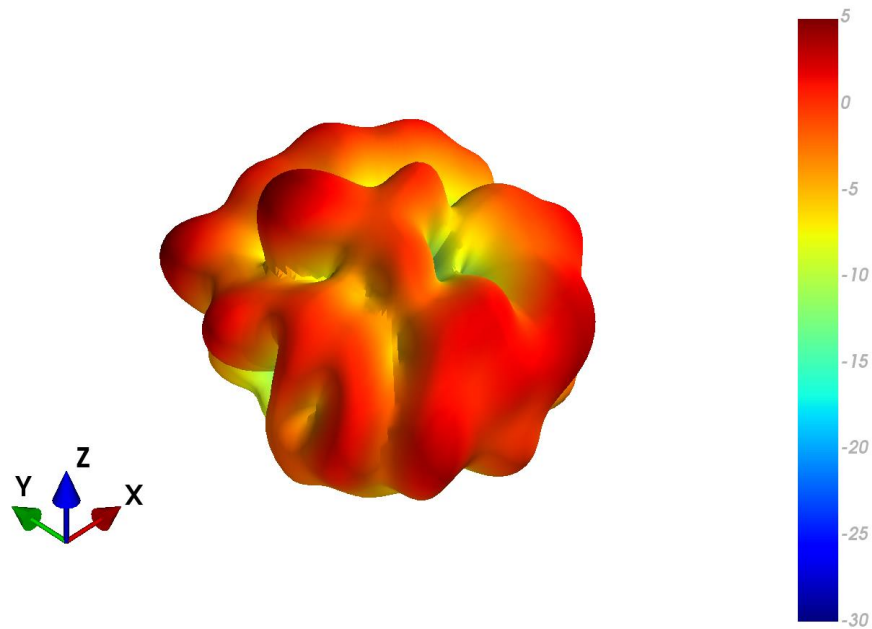

4.65 MIMO1 Wi-Fi Free Space Patterns at 5850 MHz

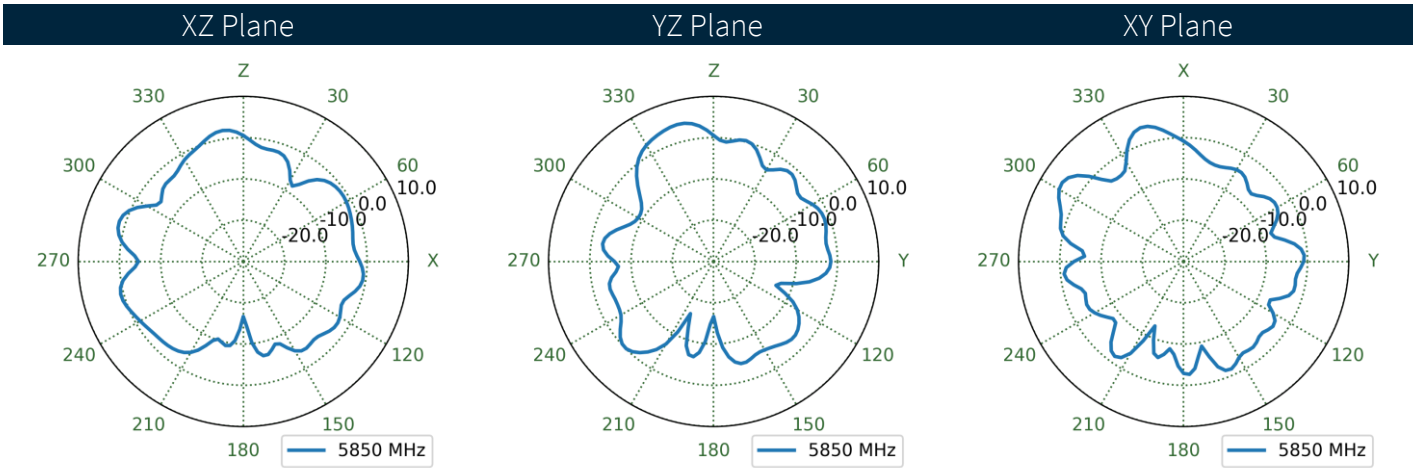
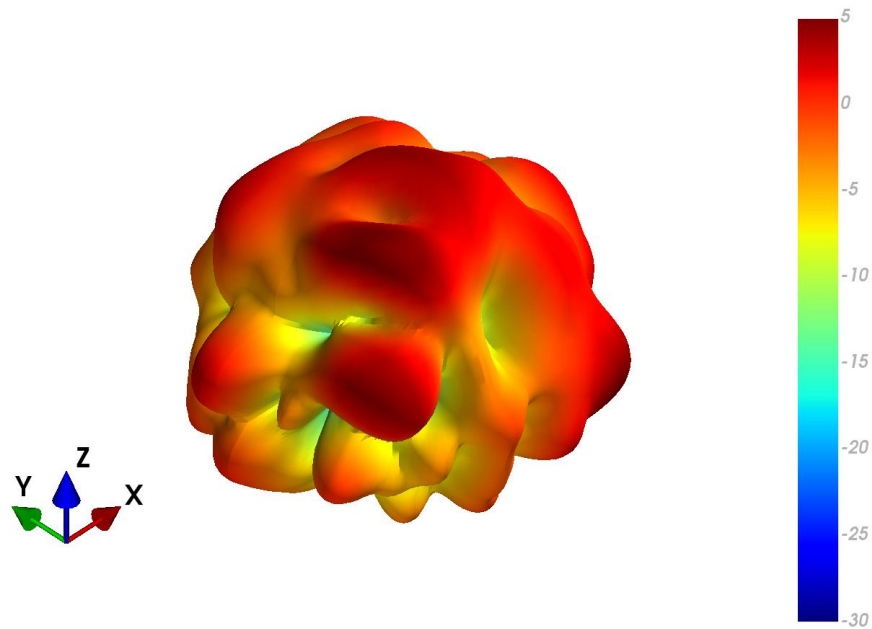

4.66 MIMO1 Wi-Fi Ground Plane Patterns at 5850 MHz

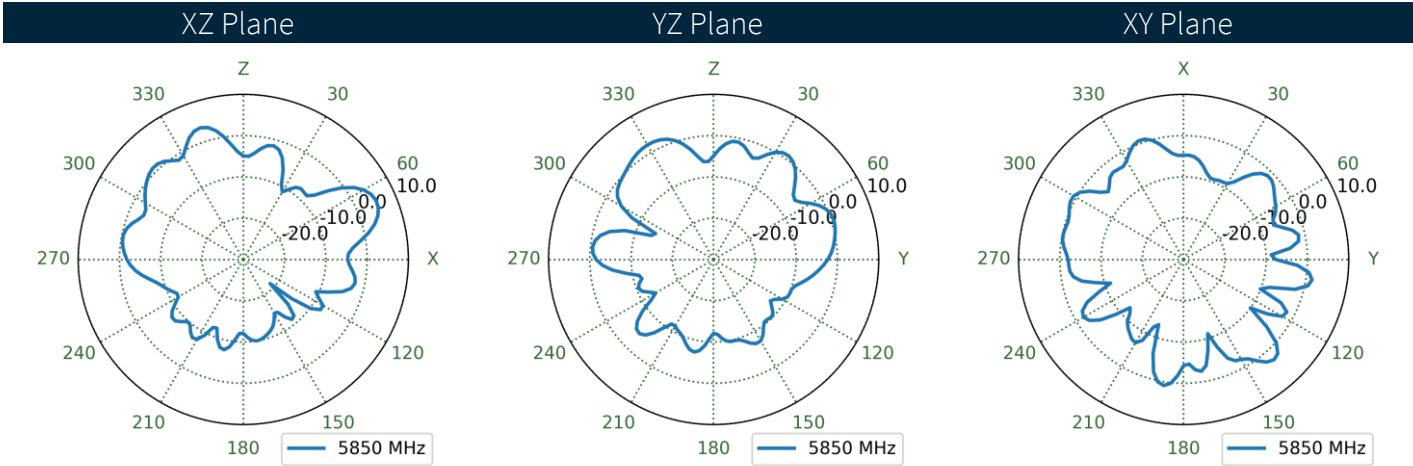
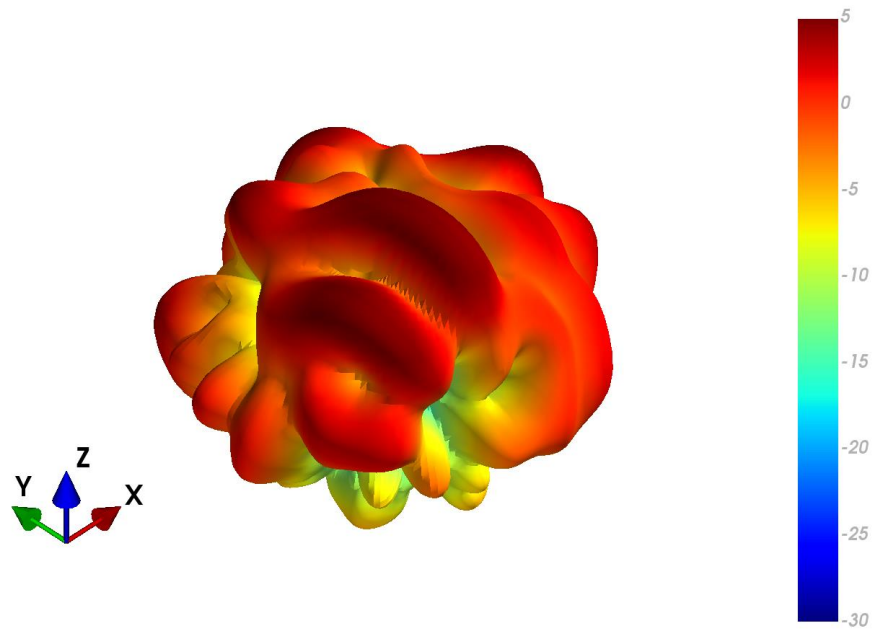

4.67 MIMO2 Wi-Fi Free Space Patterns at 5850 MHz

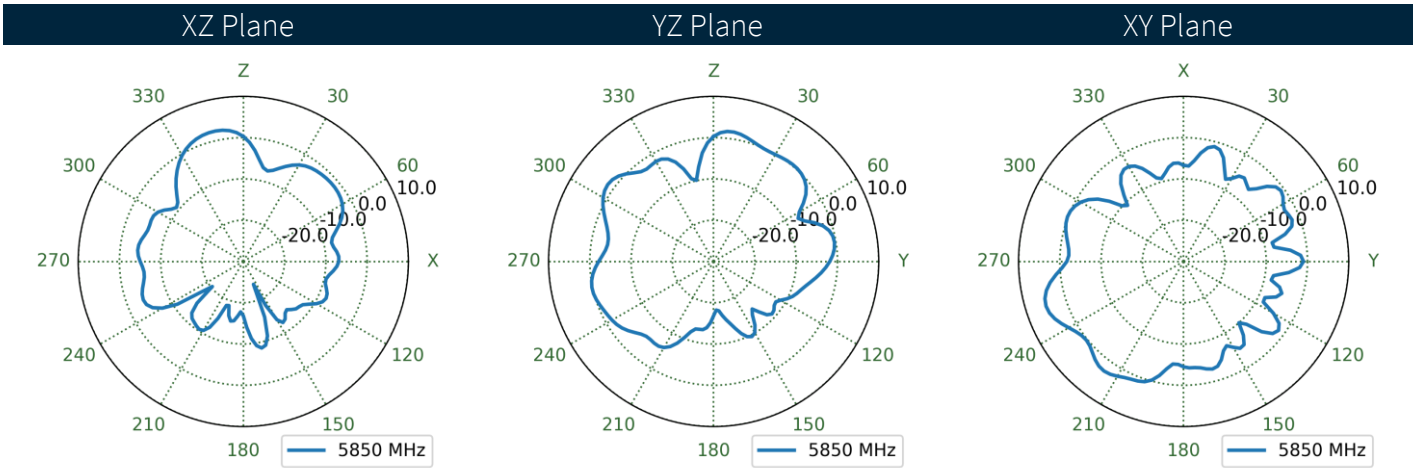
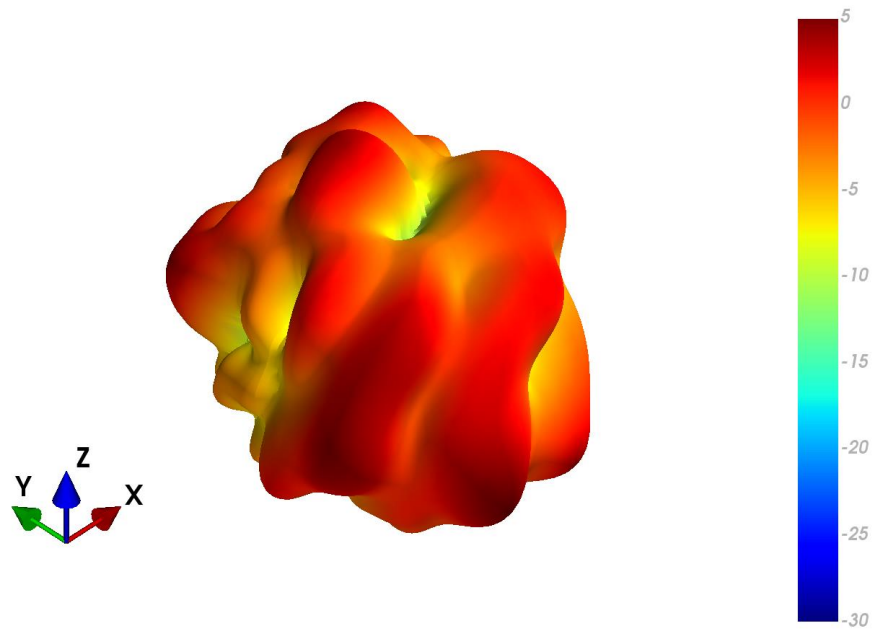

4.68 MIMO2 Wi-Fi Ground Plane Patterns at 5850 MHz

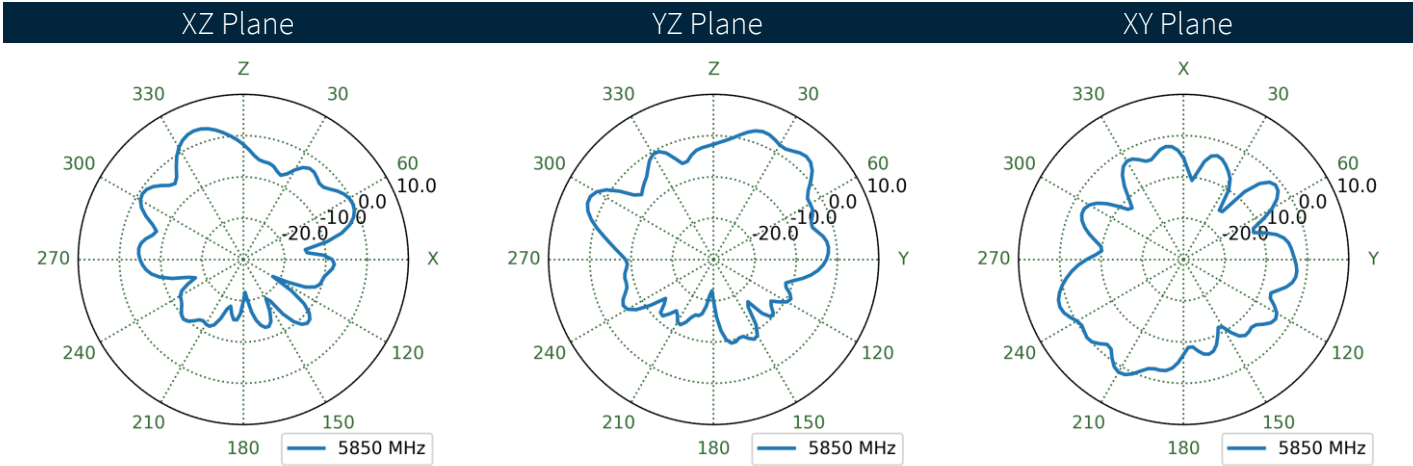
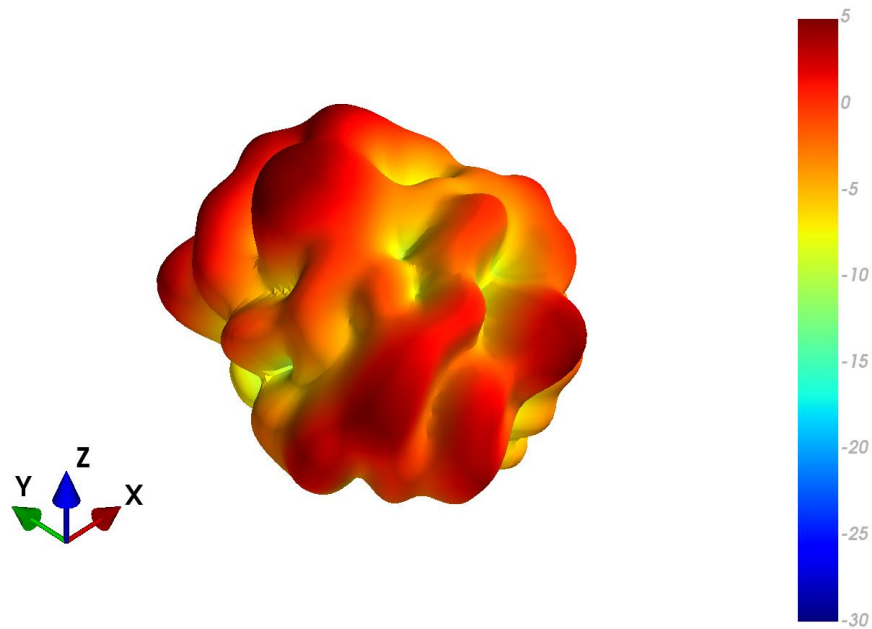

4.69 MIMO1 Wi-Fi Free Space Patterns at 6525 MHz

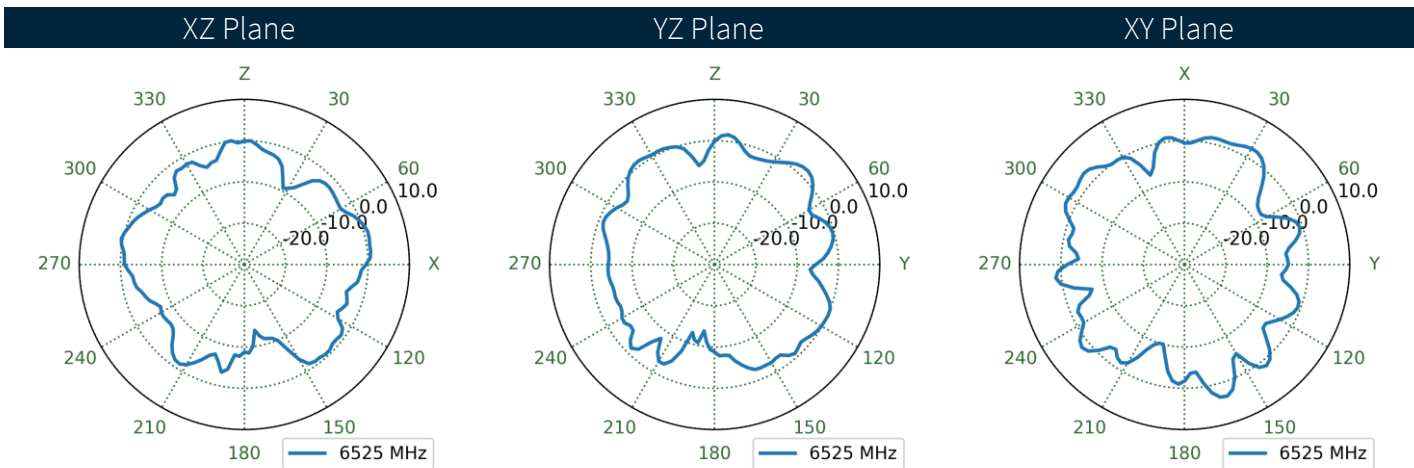
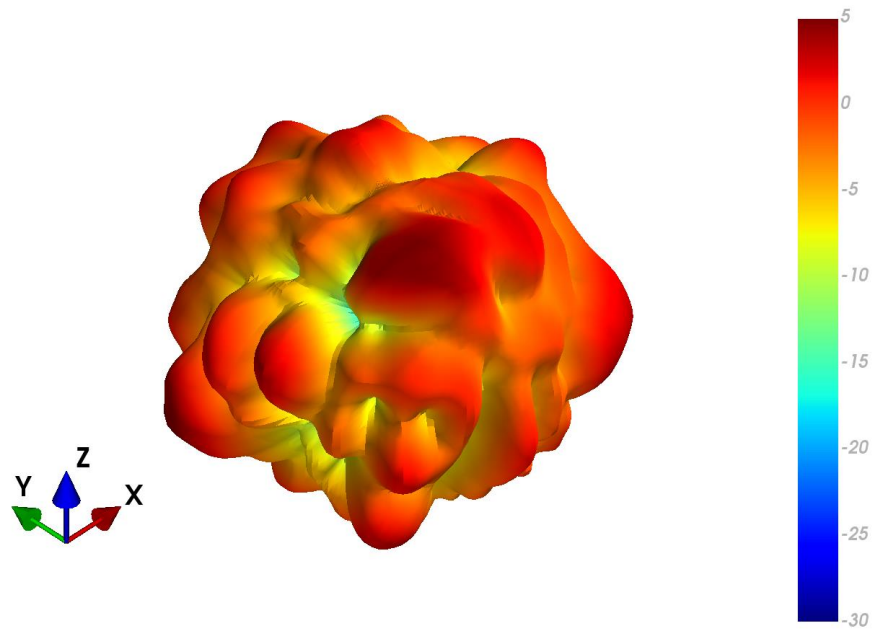

4.70 MIMO1 Wi-Fi Ground Plane Patterns at 6525 MHz

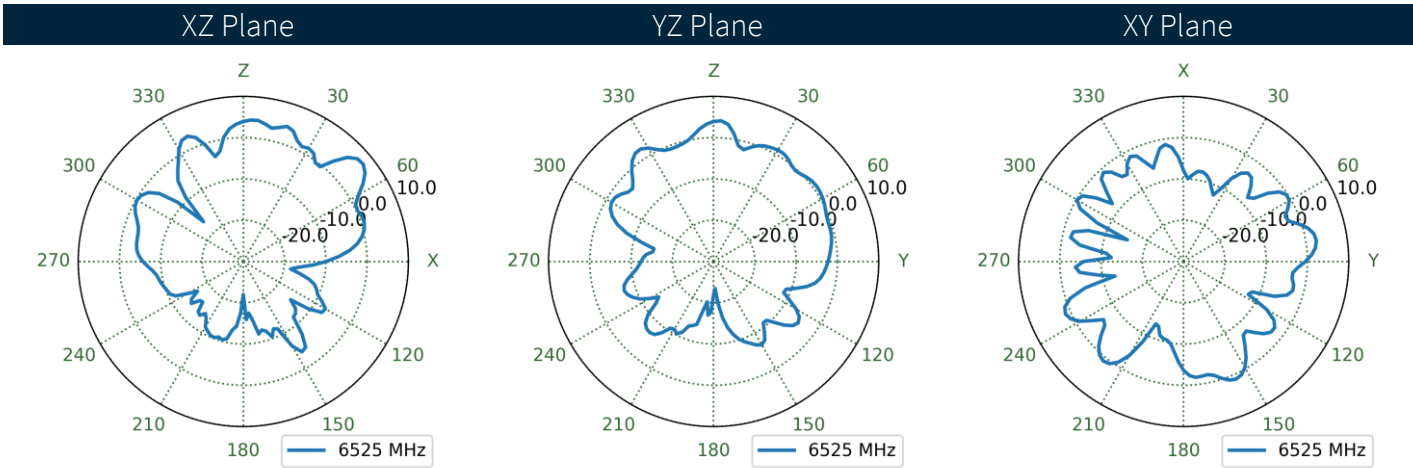
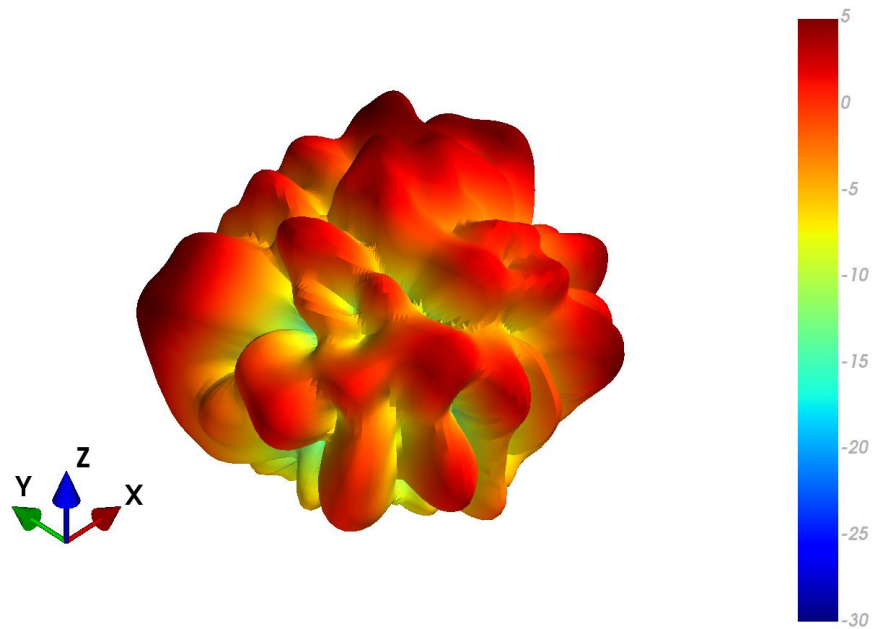

4.71 MIMO2 Wi-Fi Free Space Patterns at 6525 MHz

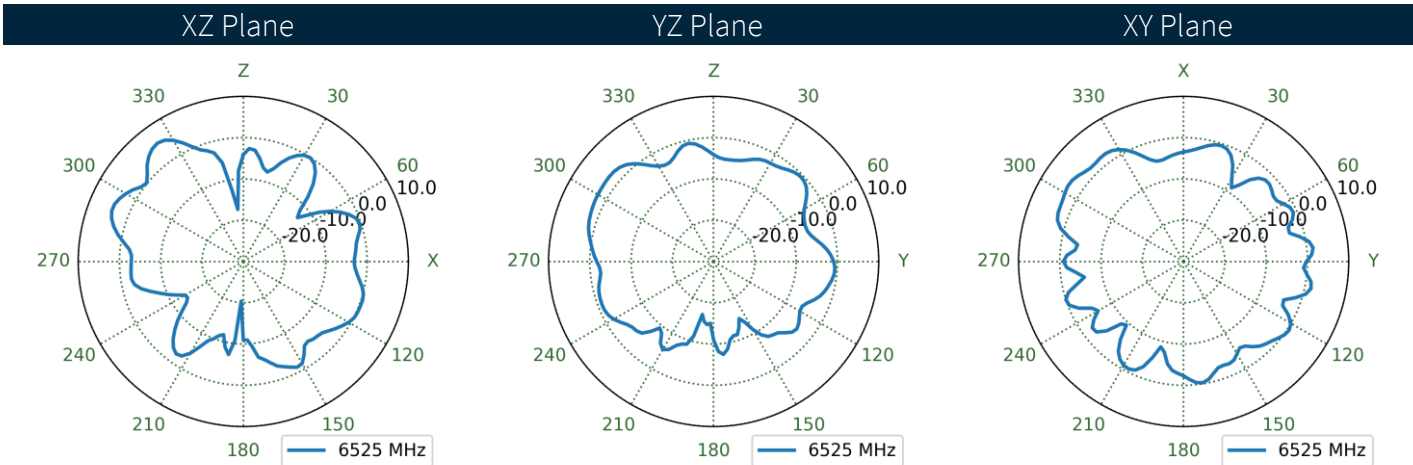
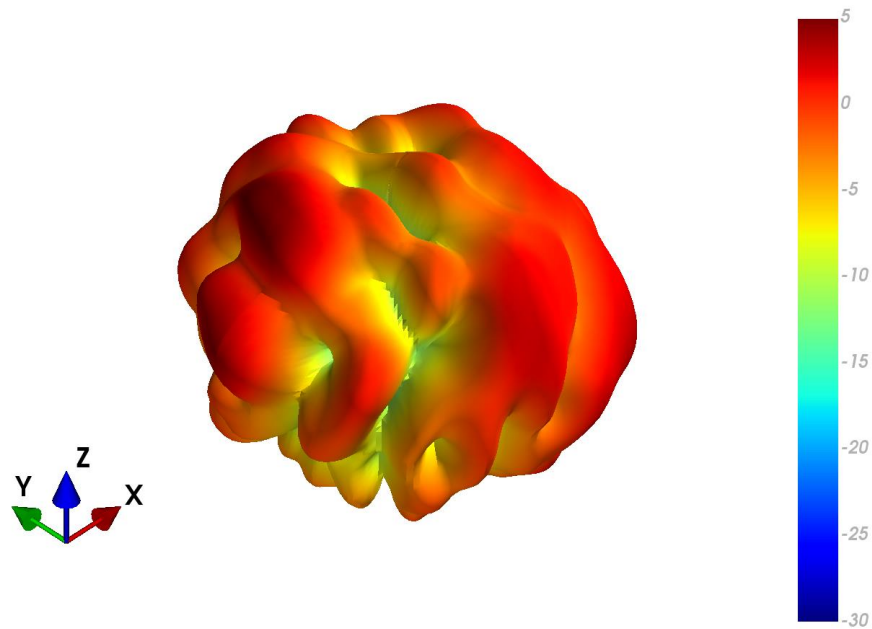

4.72 MIMO2 Wi-Fi Ground Plane Patterns at 6525 MHz

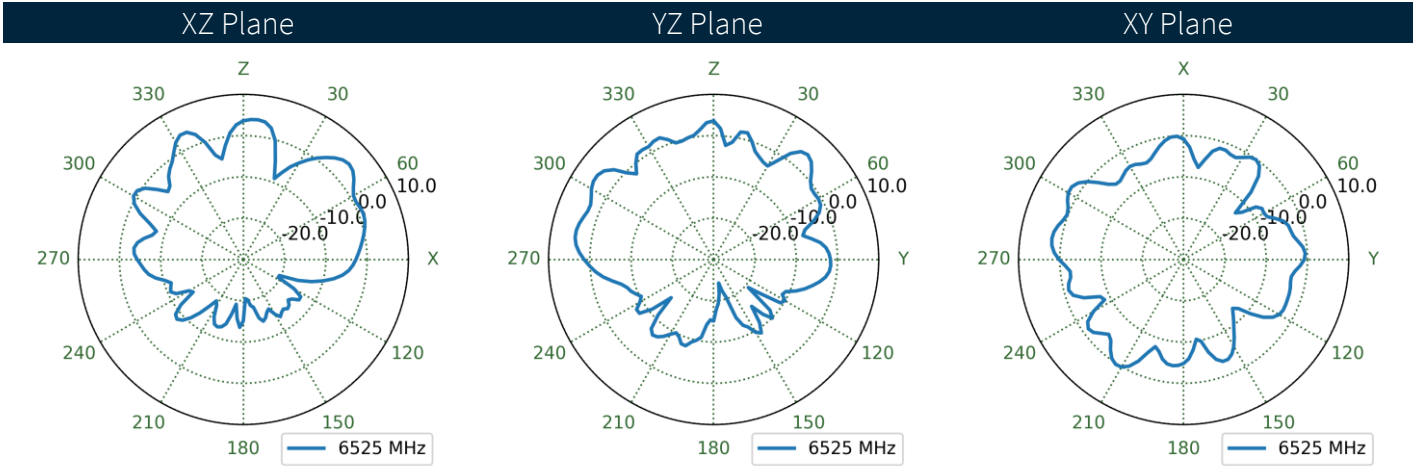
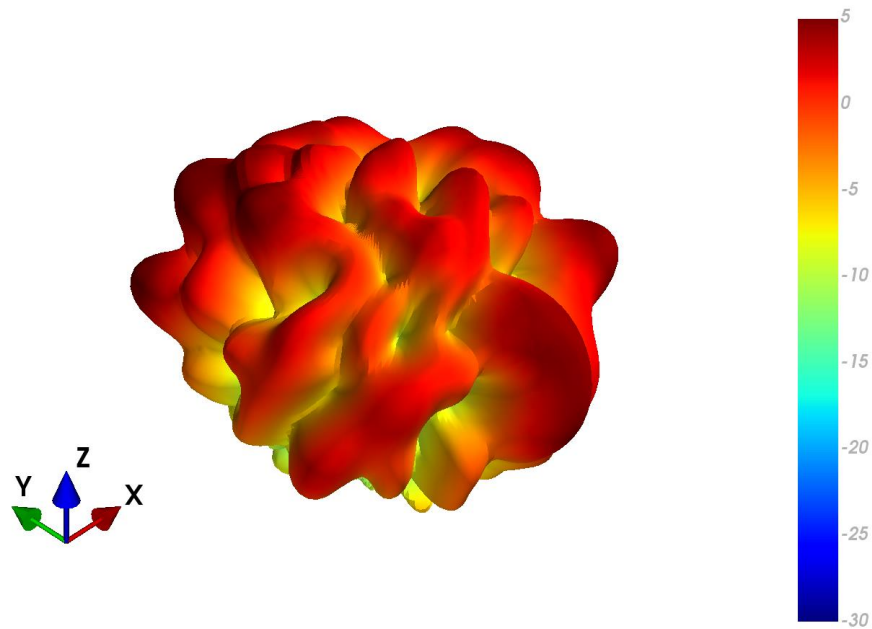

4.73 MIMO1 Wi-Fi Free Space Patterns at 7125 MHz

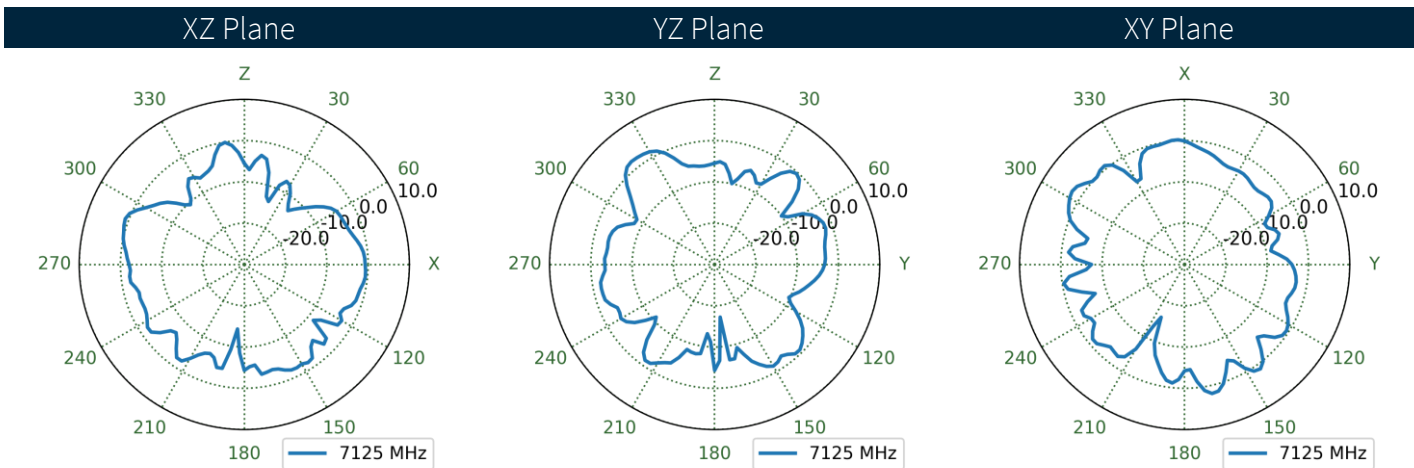
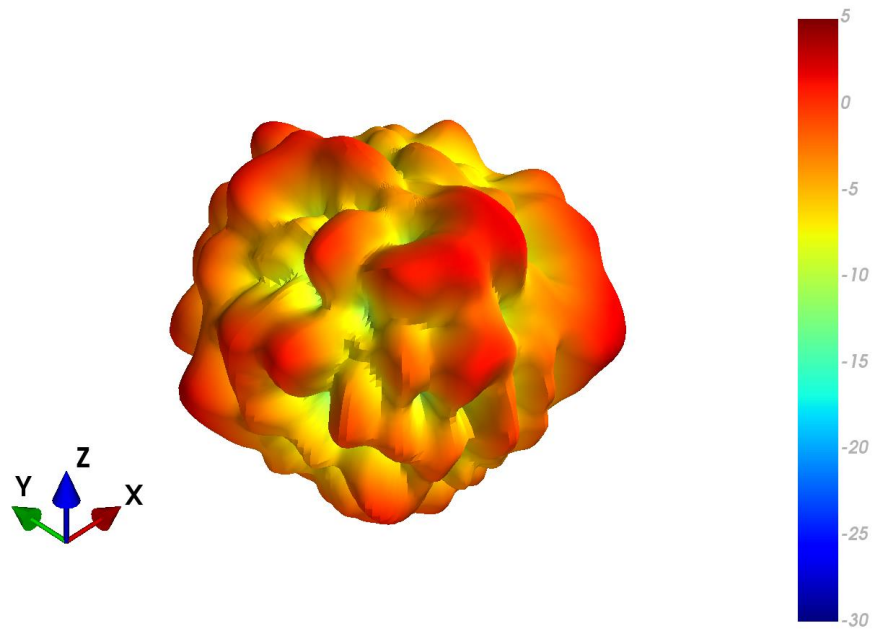

4.74 MIMO1 Wi-Fi Ground Plane Patterns at 7125 MHz

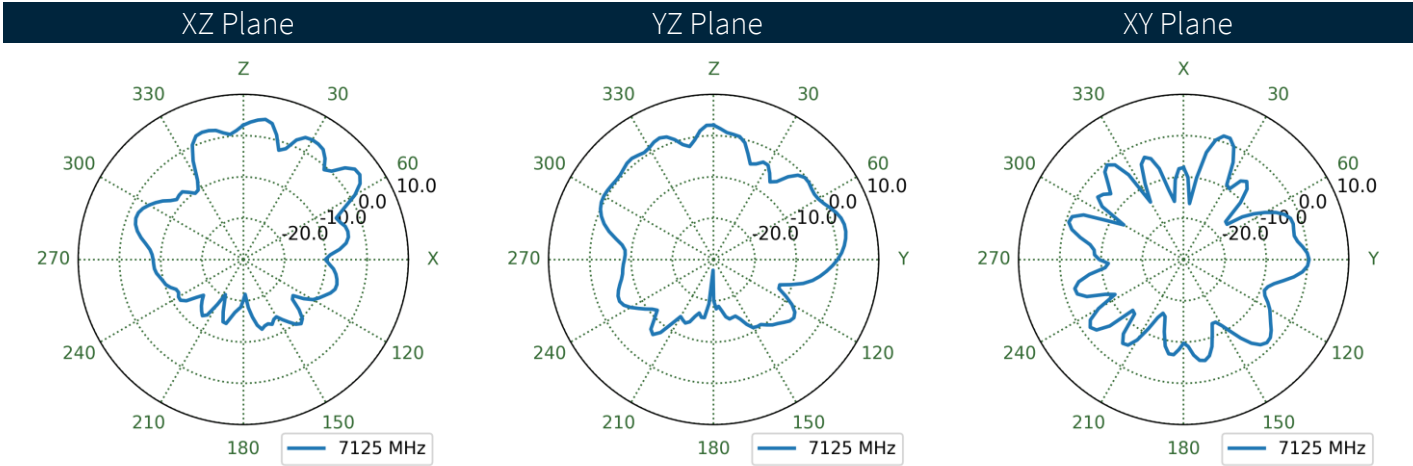
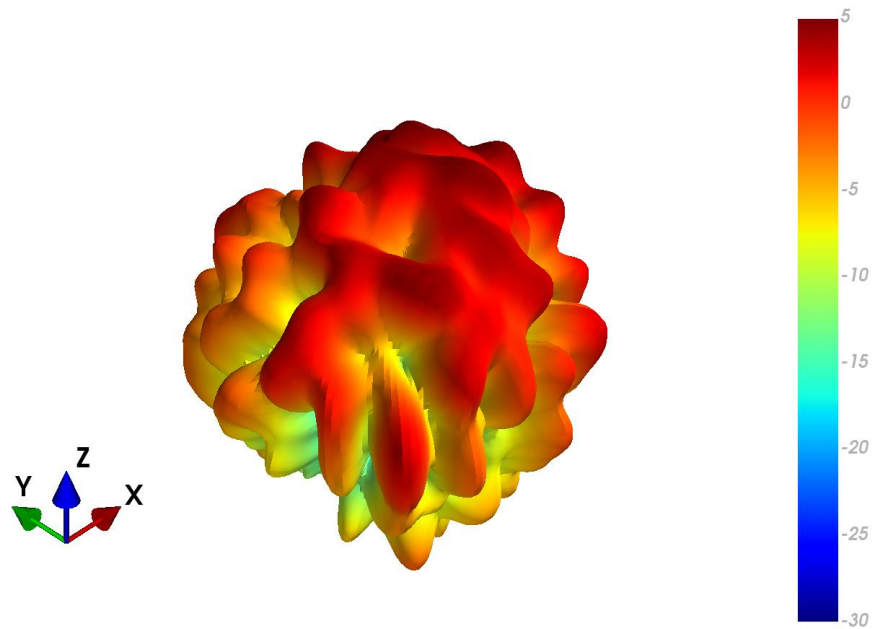

4.75 MIMO2 Wi-Fi Free Space Patterns at 7125 MHz

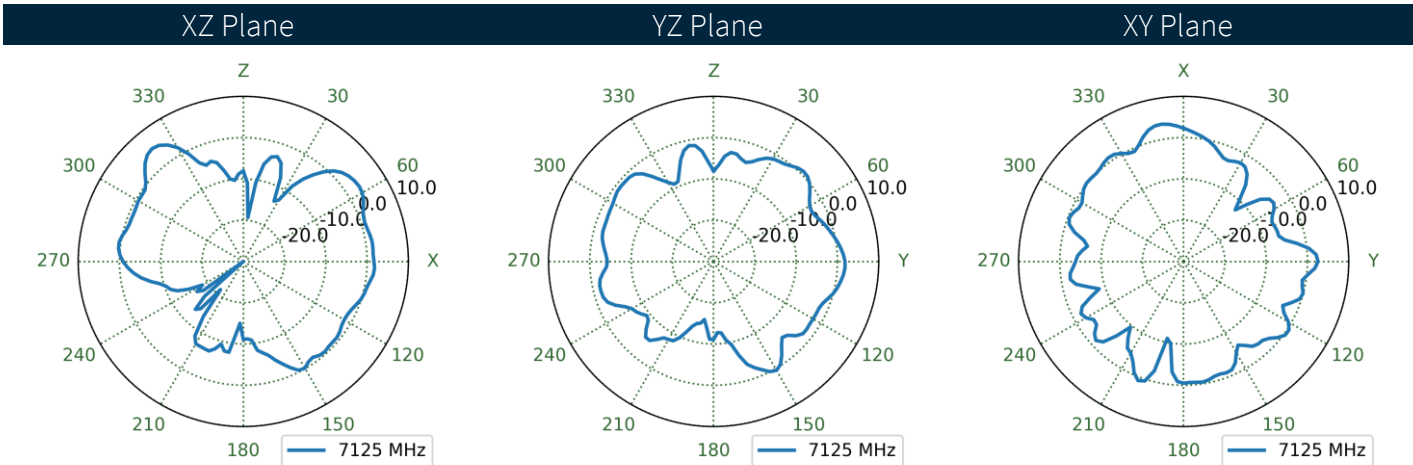
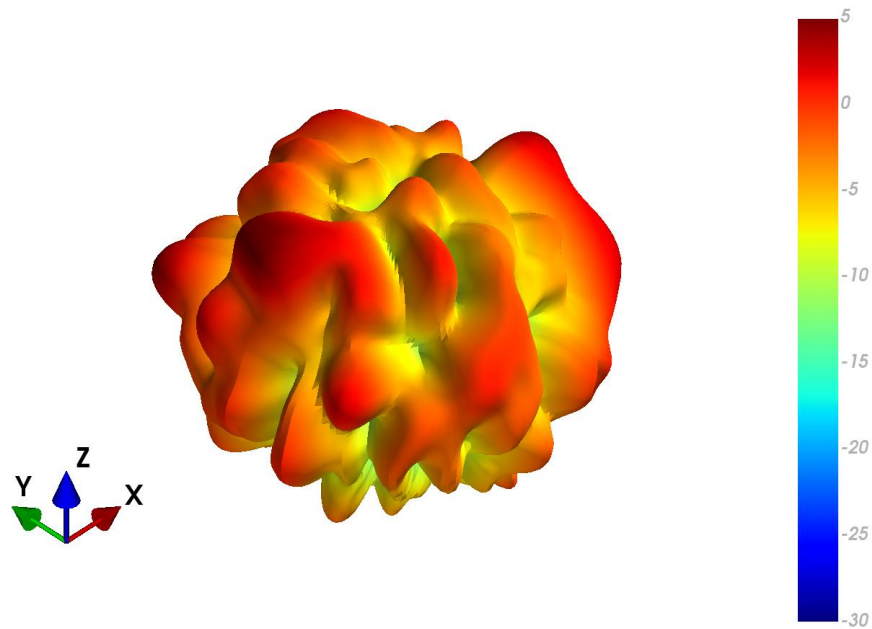

4.76 MIMO2 Wi-Fi Ground Plane Patterns at 7125 MHz

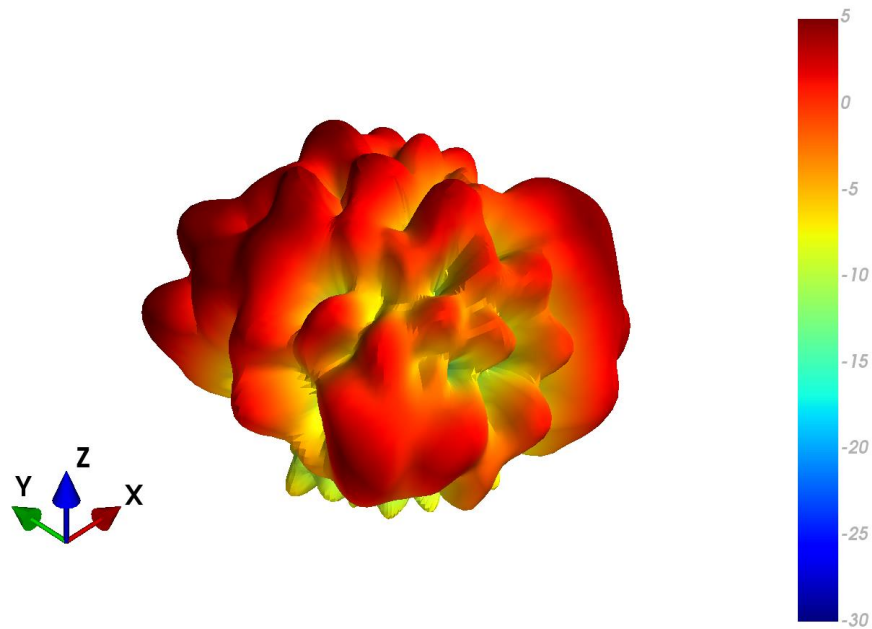

XZ Plane YZ Plane XY Plane

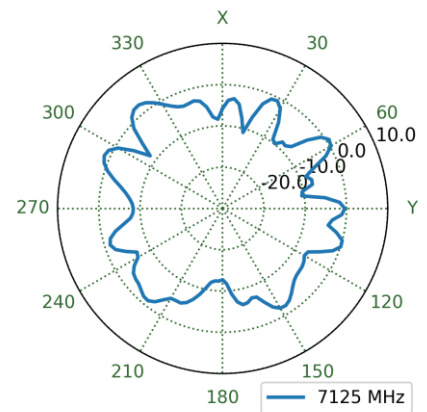
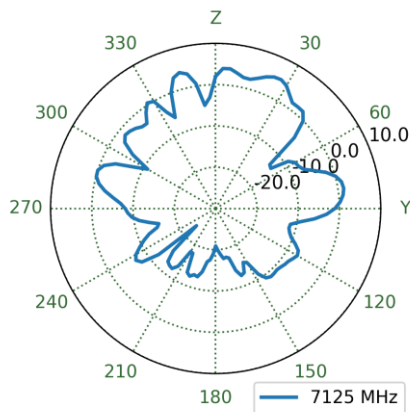
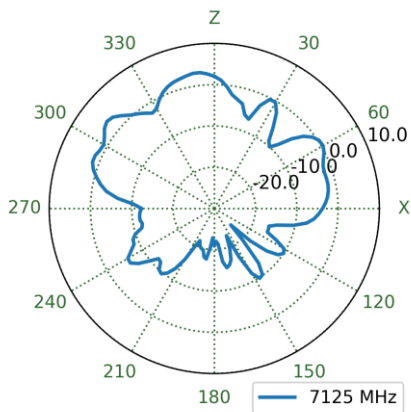

5. Mechanical Drawing

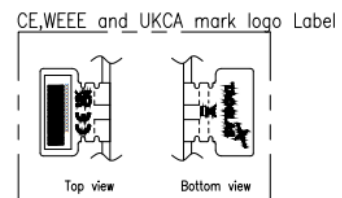
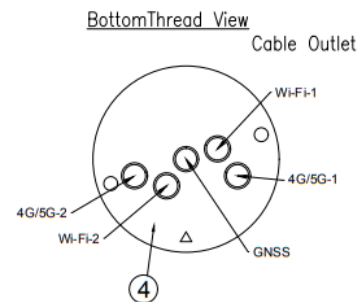
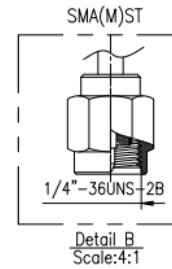
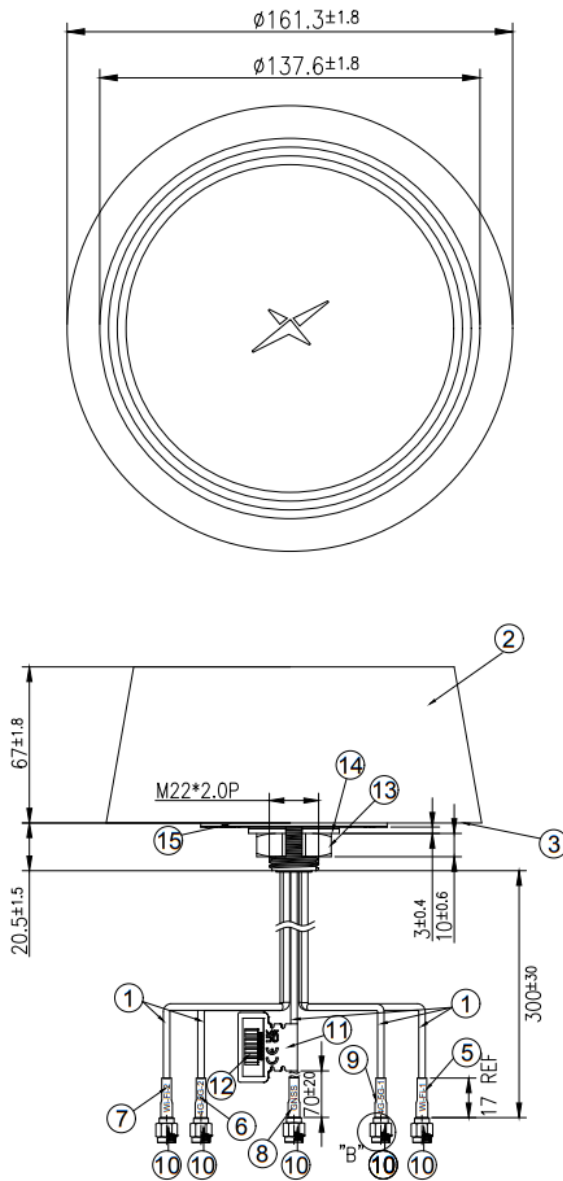

Detail A
 Scale:1.25:1

	Name	Material	Finish	QTY
1	RG174 Coaxial Cable	PVC	Black	5
2	Top Plastic Shell	PC/SABIC EXL1414	Black	1
3	Bottom Plastic	PC/SABIC EXL1414	Black	1
4	Cable Rubber	Silicone Rubber	Black	1
5	Heat Shrink Tube (Wi-Fi-1)	PE	Yellow Tube/Black Text	1
6	Heat Shrink Tube (4G/5G-2)	PE	Red Tube/White Text	1
7	Heat Shrink Tube (Wi-Fi-2)	PE	Yellow Tube/Black Text	1
8	Heat Shrink Tube (GNSS)	PE	Blue Tube/White Text	1
9	Heat Shrink Tube (4G/5G-1)	PE	Red Tube/White Text	1
10	SMA(M)ST for RG174/RG316	Brass	Au Plated	5
11	CE, WEEE and UKCA mark logo Label	PEPA	White	1
12	Barcode Label	PET	White	1
13	Nut Steel M22xP2.0xH10 Cut	Steel/S45C	Zn-Ni Plated	1
14	Washer_Cut	Steel/S45C	Zn-Ni Plated	1
15	Double sided adhesive	E4382 +3M 9448 2.5T	Black	1

6. Installation Instructions

A Introduction

The Taoglas Synergy X is an external permanent mount, combination antenna that can be provided with combinations of one active GNSS, four 5G/4G and 4 dual-band Wi-Fi antennas. The Synergy is available with an M22 threaded boss for surface mounting, along with 3M adhesive for added sealing. The Synergy X is ideal for vehicle panels of up to 6mm (0.23") thick with a threaded boss length of 20.5mm (0.81"). The Synergy X is IP67 rated and also includes an foam gasket to seal from any water ingress on the mounting surface.



Electrical Safety

The Synergy contains an active GPS/GNSS antenna.

Rated voltage: 3-5VDC Rated current: 20mA maximum

The supply to this device must be provided with overcurrent protection of 1A maximum.

Power consumption@1.8V (mA) 8.7 mA | Power consumption@3.0V (mA) 9.0 mA | Power consumption@5.5V (mA) 11 mA

B Mounting & Location

For prime performance, the Synergy X is recommended to be fitted on a metal panel. Optimum ground plane size is 300mm x 300mm (11.8" x 11.8"). When mounting on a vehicle roof panel ensure to mount on a flat surface, and measure for a central position. Care should be taken to mount the Synergy antenna as far as possible from other roof-mounted features such as the aircon unit, light bar etc.



Sealing

In order to ensure that the installation is properly sealed against the mounting surface care must be taken regarding curvature of the mounting panel. It is highly recommended to install the antenna on a clean, flat and level surface. After installation the compression of the foam gasket and adhesive against the mounting panel should be checked and a small bead of neutral cure silicone sealant can be applied around the periphery of the enclosure if required.

C Surface Preparation

When preparing to drill the hole, mask the area around the hole position to protect the surface. Drill a pilot hole and increase the hole size to $\varnothing 24\text{mm}$ ($\frac{7}{8}"$). Ensure the drill bit does not contact the headliner. Deburr and clean the area around the hole carefully removing all waste.

Remove paint and primer from under panel surface to ensure adequate earth contact by washer and nut. Apply petroleum jelly or paint around cut edge of the hole to prevent corrosion

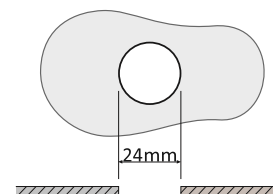

D Adhesive Patch

On the underside of the antenna there is a 3M adhesive foam gasket. Peel away the 3M adhesive protection and feed the cables through the hole. Position the antenna over the hole and press down onto the panel with pressure. This adhesion will make ensure will be securely mounted and will also allow for extremely minimal curvature on the roof of a vehicle.



E Securing the Mount

A split nut is used to easily fit onto the thread through the cables. The nut is attached from the underside of the panel, it should easily twist onto the thread and then secured in place with a final tighten with a spanner. After tightening, double check the antenna to make sure that it is properly secured.

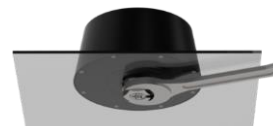

Torque Values	kgf-cm	N-m
Plastic Nut	85 ±5	8.3 ±0.5
Metal Nut	180 ±5	17.6 ±0.5

F Cable Routing and Connection

The pigtail cables supplied are RG-174 for all feeds. The heatshrink will denote which cable is which for ease of installation. Connect each individual connector to the correct port of the router, if any cable is unused please fit a 50Ω terminator to the individual connection.

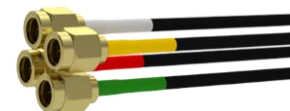

G Notices



Caution

To comply with FCC RF Exposure requirements in section 1.1310 of the FCC Rules, antennas used with this device must be installed to provide a separation distance of at least 20 cm from all persons to satisfy RF exposure compliance.



Warning

Do not operate the equipment in an explosive atmosphere.



European Waste Electronic Equipment Directive 2012/19/EU

Please ensure that your old Waste Electricals and Electronics are recycled do not throw them away into standard waste.



Hazardous Substances Directive (RoHS) 2011/65/EU / 2015/863/EU Directive 2014/53/EU Radio Equipment Directive (RED)

View CE Certificate online:

<https://www.taoglas.com/wp-content/uploads/pdf/CE-Declaration-of-Conformity-RED-RoHS-MA15XX-Synergy-Series.pdf>

Harmonised Standards and References:

EN 301 489-1 (V2.2.1): ElectroMagnetic Compatibility (EMC) standard for radio equipment and services;
Part 1: Common technical requirements. Referencing CENELEC EN 55032 Class B.

Waiver: This document represents information compiled by Taoglas to the best of our current knowledge. This is not intended to be used as a representation or warranty of fitness of the products described for any particular purpose. This document details guidelines for general information purposes only. When planning installations, always seek specialist advice and ensure that the products are always installed by a properly qualified installer in accordance with applicable regional laws and regulations.

All copyrights, trademarks and any other intellectual property rights related are owned by Taoglas Group Holdings Limited.

7. Packaging



1pc MA1555.A.001 per PE Bag
Weight: 535g

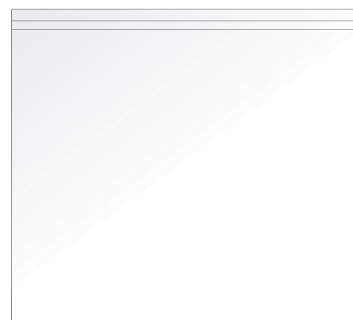

8pcs MA1555.A.001 per Carton
Carton Dimensions: 360*360*310mm
Weight: 4.5Kg

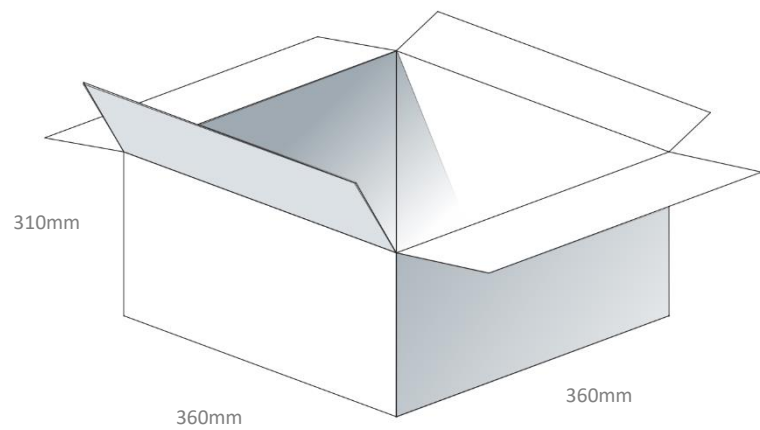

Changelog for the datasheet

SPE-22-8-161 - MA1555.A.001

Revision: C (Current Version)

Date: 2023-05-16

Notes: Added Installation Instructions

Author: Cesar Sousa

Previous Revisions

Revision: B

Date: 2023-03-02

Notes: Updated specifications

Author: Cesar Sousa

Revision: A (Original First Release)

Date: 2022-10-09

Notes: First initial Release

Author: Gary West



www.taoglas.com

