



TAOGLAS®



Datasheet

Colosseum

Part No:
MA841.A.BI.002

Description

Colosseum MA841 2in1 5G/4G MIMO Permanent Mount Antenna

Features:

- 2* 5G/4G MIMO 600~6000MHz
- Screw-Mount [Permanent Mount]
- Worldwide 5G/4G Bands
- IP67 Rated Enclosure
- Dimensions: Diameter: 94.3mm, Height: 57.4 mm
- 1m RG-316 with SMA(M) connectors as standard
- Custom Cables and Connectors Available
- RoHS & Reach Compliant

1.	Introduction	3
2.	Specification	4
3.	Antenna Characteristics	7
4.	Radiation Patterns	11
5.	Mechanical Drawing	44
6.	Installation Recommendation	45
7.	Packaging	46
<hr/>		
	Changelog	47

Taoglas makes no warranties based on the accuracy or completeness of the contents of this document and reserves the right to make changes to specifications and product descriptions at any time without notice. Taoglas reserves all rights to this document and the information contained herein. Reproduction, use or disclosure to third parties without express permission is strictly prohibited.

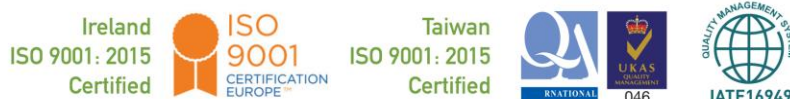

1. Introduction



The Colosseum MA841 antenna is a low profile, heavy-duty, fully IP67 waterproof external M2M antenna for use in worldwide telematics applications which require best in class 5G/4G LTE MIMO performance.

This unique product, only 57.4mm height, delivers powerful worldwide 5G/4G MIMO antenna technology from 600 to 6000MHz, so it provides coverage to all bands within that spectrum to maintain a stable connection over the lifetime of your system.

Typical applications

- Remote Asset and Pipeline Monitoring
- Digital Signage
- HD Video over LTE
- First Responder and Emergency Services
- Automotive Vehicle Tracking and Telematics

5G/4G applications demand high speed data uplink and downlink. High efficiency and high gain MIMO antennas are necessary to achieve the required signal to noise ratio and throughput required to solve these challenges. Taoglas also takes care to have high isolation between the two MIMO antennas to prevent self-interference. Low loss cables are used to keep efficiency high over long cable lengths. In contrast, smaller MIMO antennas with poorer quality thinner cables will have much reduced efficiency and isolation, which would lead to a large drop in system throughput or drops and may indeed not make a system connection at all.

Cable length and connector types are customizable. Contact your regional Taoglas customer support team for installation instructions or further support.

2. Specification

LTE Electrical									
Band	Frequency (MHz)	Antenna	Test setup	Efficiency (%)	Average Gain (dB)	Peak Gain (dBi)	Impedance	Polarization	Radiation Pattern
5GNR/4G Band 71	617-698	LTE1	30x30cm Groundplane	43.8	-3.59	4.06	50 Ω	Linear	Omni
		LTE2	30x30cm Groundplane	62.9	-2.01	4.04			
		LTE1	Free space	36.3	-4.40	1.08			
		LTE2	Free space	44.4	-3.53	2.34			
4G/3G Band 12,13,14,17,28,29	698-806	LTE1	30x30cm Groundplane	49.3	-3.07	3.53			
		LTE2	30x30cm Groundplane	48.3	-3.16	3.49			
		LTE1	Free space	34.2	-4.66	1.15			
		LTE2	Free space	46.4	-3.34	3.87			
4G/3G/NB-IoT/Cat M Band 5,8,18,19,20,26,27	824-960	LTE1	30x30cm Groundplane	47.9	-3.20	2.61			
		LTE2	30x30cm Groundplane	48.9	-3.11	2.73			
		LTE1	Free space	39.9	-3.99	1.91			
		LTE2	Free space	41.3	-3.84	2.82			
5GNR/4G Band 21,32,74,75,76	1427-1518	LTE1	30x30cm Groundplane	36.5	-4.38	3.16			
		LTE2	30x30cm Groundplane	30.0	-5.23	1.72			
		LTE1	Free space	27.6	-5.59	0.30			
		LTE2	Free space	35.4	-4.51	0.90			
4G/3G Band 1,2,3,4,9,23,25,35,39,66	1710-2200	LTE1	30x30cm Groundplane	44.7	-3.49	3.70			
		LTE2	30x30cm Groundplane	46.4	-3.33	4.34			
		LTE1	Free space	41.0	-3.87	2.10			
		LTE2	Free space	45.4	-3.43	2.52			
4G/3G Band 7,30,38,40,41	2300-2690	LTE1	30x30cm Groundplane	52.0	-2.84	5.87			
		LTE2	30x30cm Groundplane	47.0	-3.28	5.67			
		LTE1	Free space	52.8	-2.77	3.18			
		LTE2	Free space	54.4	-2.65	3.85			
5GNR/4G Band 22,42,48,77,78,79	3300-5000	LTE1	30x30cm Groundplane	45.5	-3.42	7.22			
		LTE2	30x30cm Groundplane	47.1	-3.27	6.00			
		LTE1	Free space	48.0	-3.19	5.43			
		LTE2	Free space	50.2	-2.99	5.08			
LTE5200/Wi-Fi5800	5150-5925	LTE1	30x30cm Groundplane	25.3	-5.97	2.69			
		LTE2	30x30cm Groundplane	21.6	-6.66	3.33			
		LTE1	Free space	18.5	-7.34	1.99			
		LTE2	Free space	26.9	-5.70	2.78			

*Tested with 1m of RG-316

5G/4G Bands						
Band Number	5G NR / FR1 / LTE / LTE-Advanced / WCDMA / HSPA / HSPA+ / TD-SCDMA					
	Uplink	Downlink	LTE 1 - 30x30cm GroundPlane	LTE 2 - 30x30cm GroundPlane	LTE1 - Free Space	LTE2 - Free Space
B1	1920 to 1980	2110 to 2170	✓	✓	✓	✓
B2	1850 to 1910	1930 to 1990	✓	✓	✓	✓
B3	1710 to 1785	1805 to 1880	✓	✓	✓	✓
B4	1710 to 1755	2110 to 2155	✓	✓	✓	✓
B5	824 to 849	869 to 894	✓	✓	✓	✓
B7	2500 to 2570	2620 to 2690	✓	✓	✓	✓
B8	880 to 915	925 to 960	✓	✓	✓	✓
B9*	1749.9 to 1784.9	1844.9 to 1879.9	✓	✓	✓	✓
B11	1427.9 to 1447.9	1475.9 to 1495.9	✓	✓	✓	✓
B12	699 to 716	729 to 746	✓	✓	✓	✓
B13	777 to 787	746 to 756	✓	✓	✓	✓
B14	788 to 798	758 to 768	✓	✓	✓	✓
B17	704 to 716	734 to 746	✓	✓	✓	✓
B18	815 to 830	860 to 875	✓	✓	✓	✓
B19	830 to 845	875 to 890	✓	✓	✓	✓
B20	832 to 862	791 to 821	✓	✓	✓	✓
B21	1447.9 to 1462.9	1495.9 to 1510.9	✓	✓	✓	✓
B22*	3410 to 3490	3510 to 3590	✓	✓	✓	✓
B23*	2000 to 2020	2180 to 2200	✓	✓	✓	✓
B24	1626.5 to 1660.5	1525 to 1559	✓	✓	✓	✓
B25	1850 to 1915	1930 to 1995	✓	✓	✓	✓
B26	814 to 849	859 to 894	✓	✓	✓	✓
B27*	807 to 824	852 to 869	✓	✓	✓	✓
B28	703 to 748	758 to 803	✓	✓	✓	✓
B29	717 to 728		✓	✓	✓	✓
B30	2305 to 2315	2350 to 2360	✓	✓	✓	✓
B31	452.5 to 457.5	462.5 to 467.5	✗	✗	✗	✗
B32	1452 to 1496		✓	✓	✓	✓
B34	2010 to 2025		✓	✓	✓	✓
B35	1850 to 1910		✓	✓	✓	✓
B36	1930 to 1990		✓	✓	✓	✓
B37	1910 to 1930		✓	✓	✓	✓
B38	2570 to 2620		✓	✓	✓	✓
B39	1880 to 1920		✓	✓	✓	✓
B40	2300 to 2400		✓	✓	✓	✓
B41	2496 to 2690		✓	✓	✓	✓
B42	3400 to 3600		✓	✓	✓	✓
B43	3600 to 3800		✓	✓	✓	✓
B45	1447 to 1467		✓	✓	✓	✓
B46	5150 to 5925		✓	✓	✗	✓
B47	5855 to 5925		✓	✗	✓	✓
B48	3550 to 3700		✓	✓	✓	✓
B49	3550 to 3700		✓	✓	✓	✓
B50	1432 to 1517		✓	✓	✓	✓
B51	1427 to 1432		✓	✓	✓	✓
B52	3300 to 3400		✓	✓	✓	✓
B53	2483.5 to 2495		✓	✓	✓	✓
B65	1920 to 2010	2110 to 2200	✓	✓	✓	✓
B66	1710 to 1780	2110 to 2200	✓	✓	✓	✓
B68	698 to 728	753 to 783	✓	✓	✓	✓
B69	2570 to 2620		✓	✓	✓	✓
B70	1695 to 1710	1995 to 2020	✓	✓	✓	✓
B71	663 to 698	617 to 652	✓	✓	✓	✓
B72	451 to 456	461 to 466	✗	✗	✗	✗
B73	450 to 455	460 to 465	✗	✗	✗	✗
B74	1427 to 1470	1475 to 1518	✓	✓	✓	✓
B75	1432 to 1517		✓	✓	✓	✓
B76	1427 to 1432		✓	✓	✓	✓
B77	3300 to 4200		✓	✓	✓	✓
B78	3300 to 3800		✓	✓	✓	✓
B79	4400 to 5000		✓	✓	✓	✓
B85	698 to 716	728 to 746	✓	✓	✓	✓
B87	410 to 415	420 to 425	✗	✗	✗	✗
B88	412 to 417	422 to 427	✗	✗	✗	✗

Mechanical	
Dimensions	Diameter: 94.3mm, Height: 57.4 mm
Casing	ASA
Base and thread	Zinc Alloy
Weight	250g
Ingress Protection Rating	IP69K
Cable	1m RG-316 standard, fully customizable
Connectors	SMA(M) standard, fully customizable

Environmental	
Operation Temperature	-40°C to 85°C
Storage Temperature	-40°C to 85°C
Humidity	Non-condensing 65°C 95% RH

3. Antenna Characteristics

3.1 Test Setup

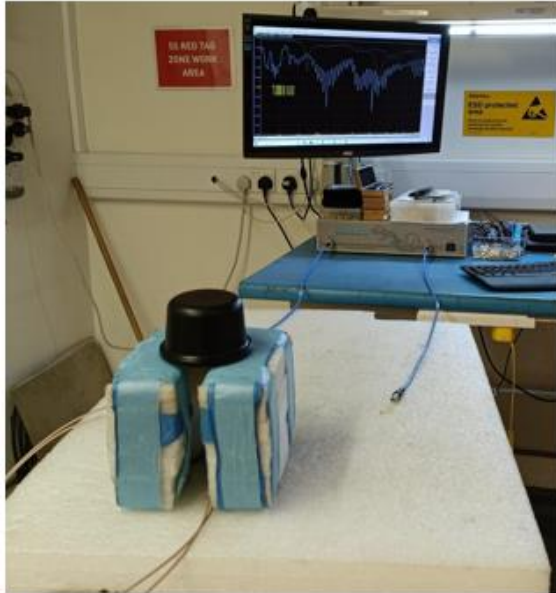
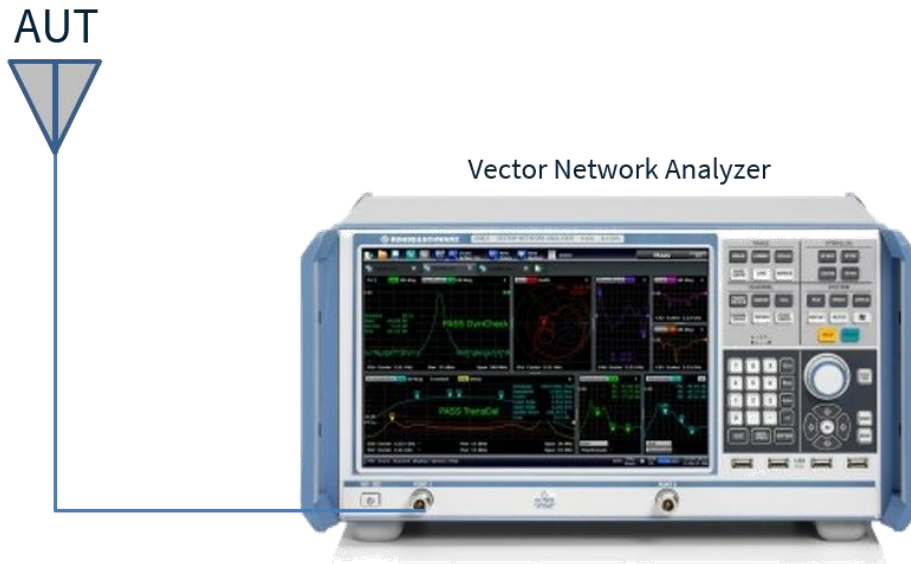

Free Space

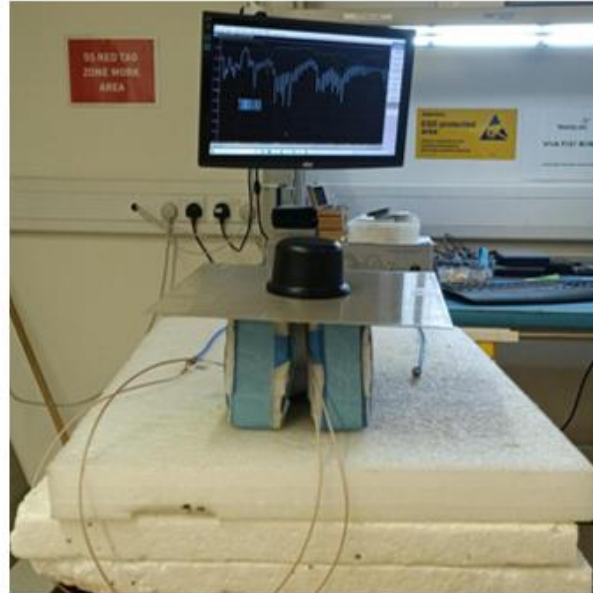

30x30cm Ground Plane

3.2 Return Loss

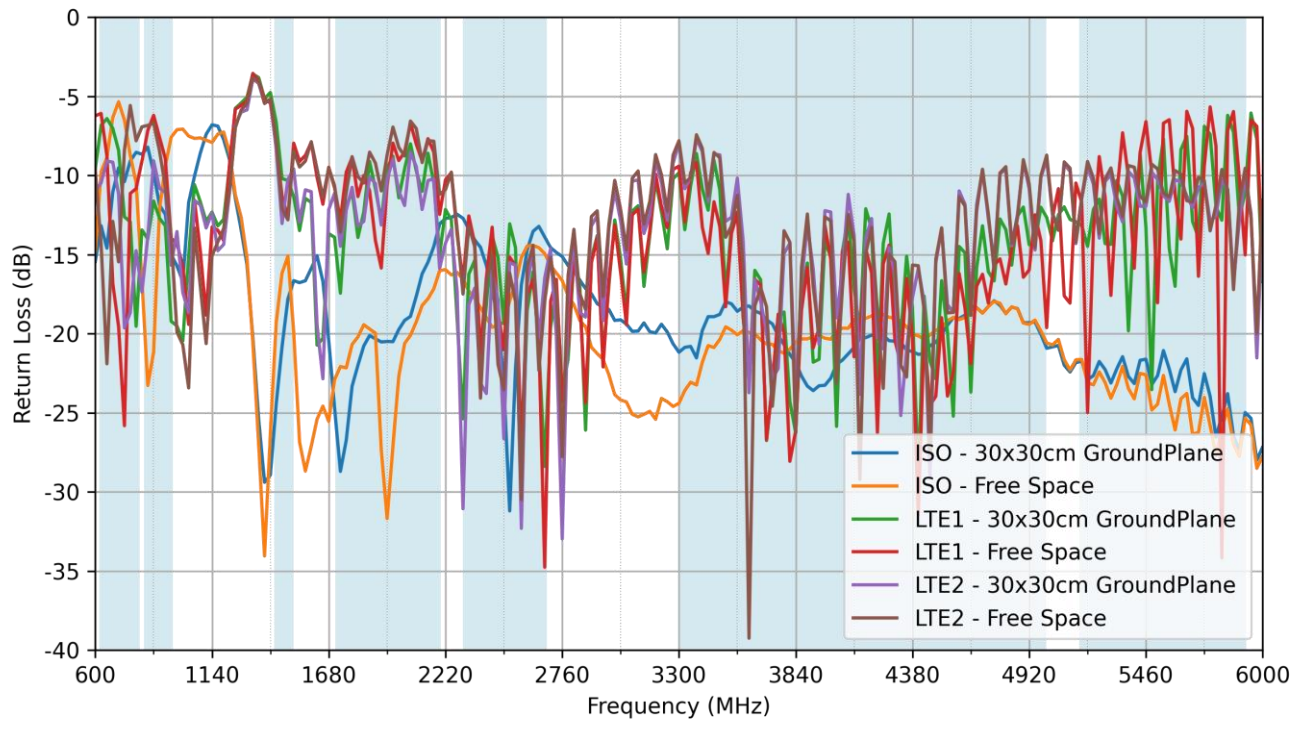

3.3 Efficiency

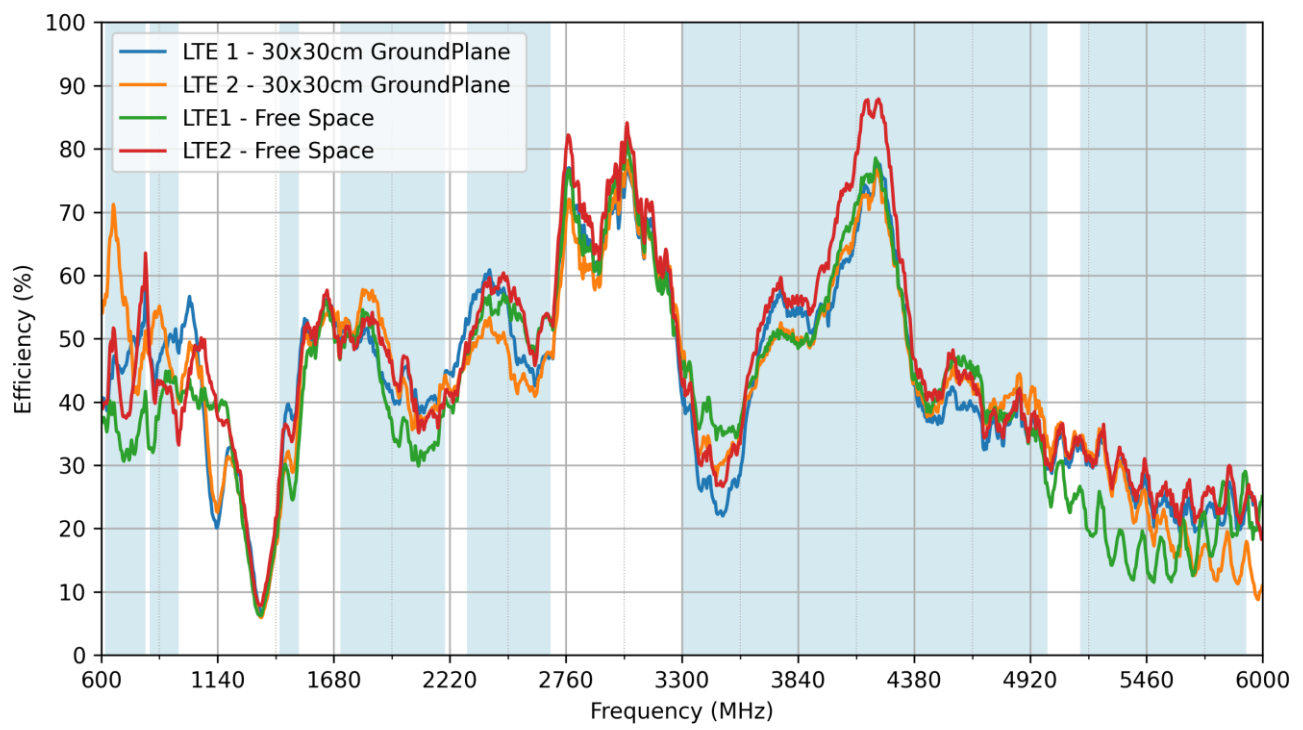

3.4 Average Gain

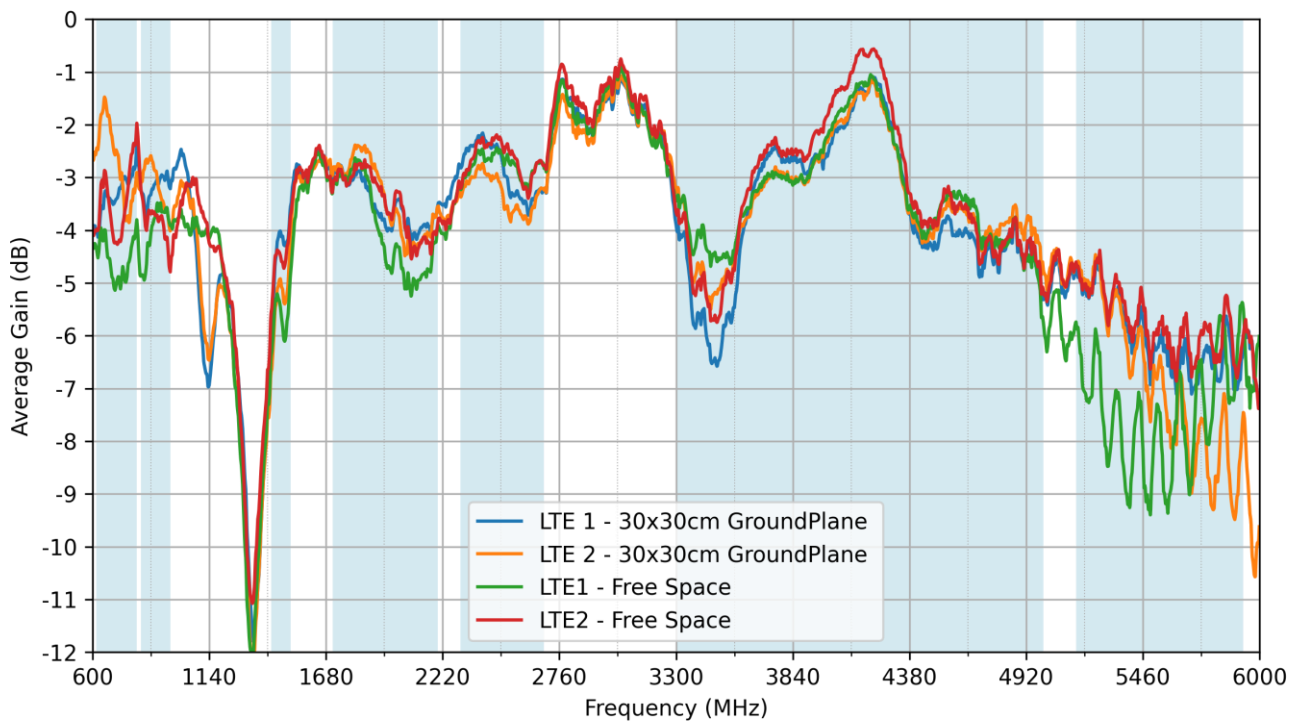

3.5 Peak Gain

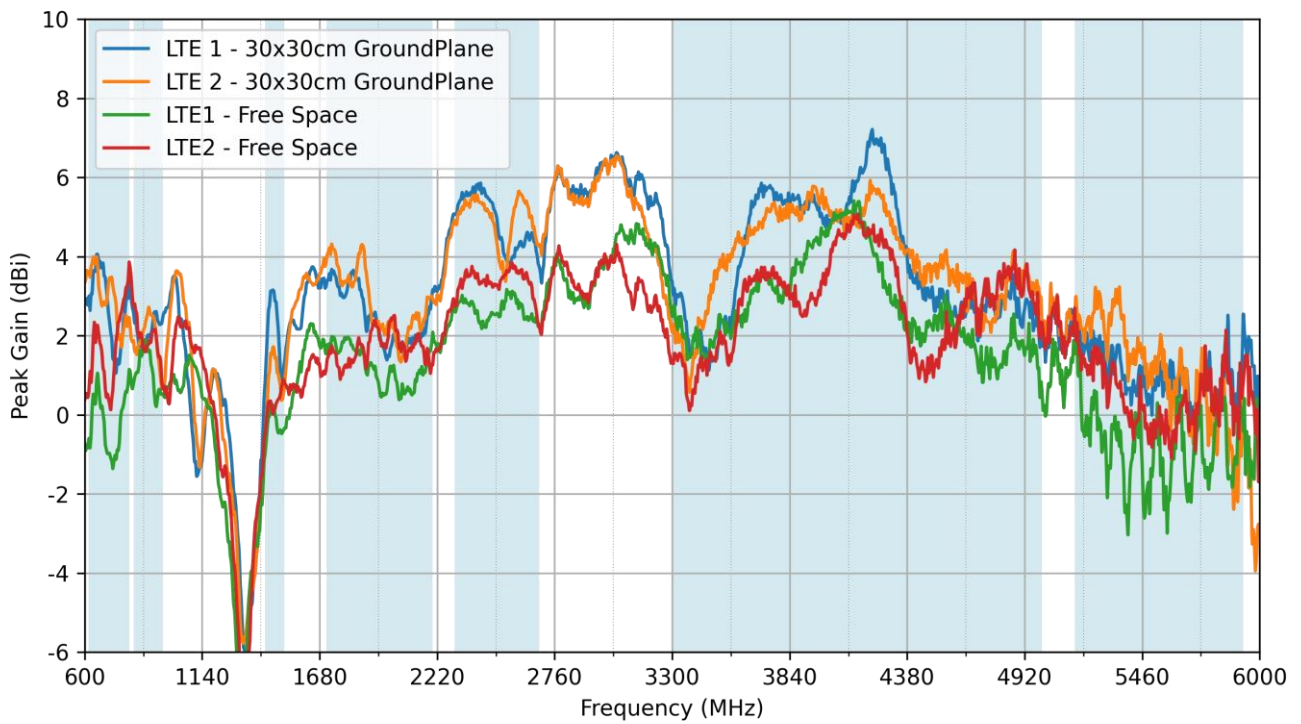

3.6 ECC

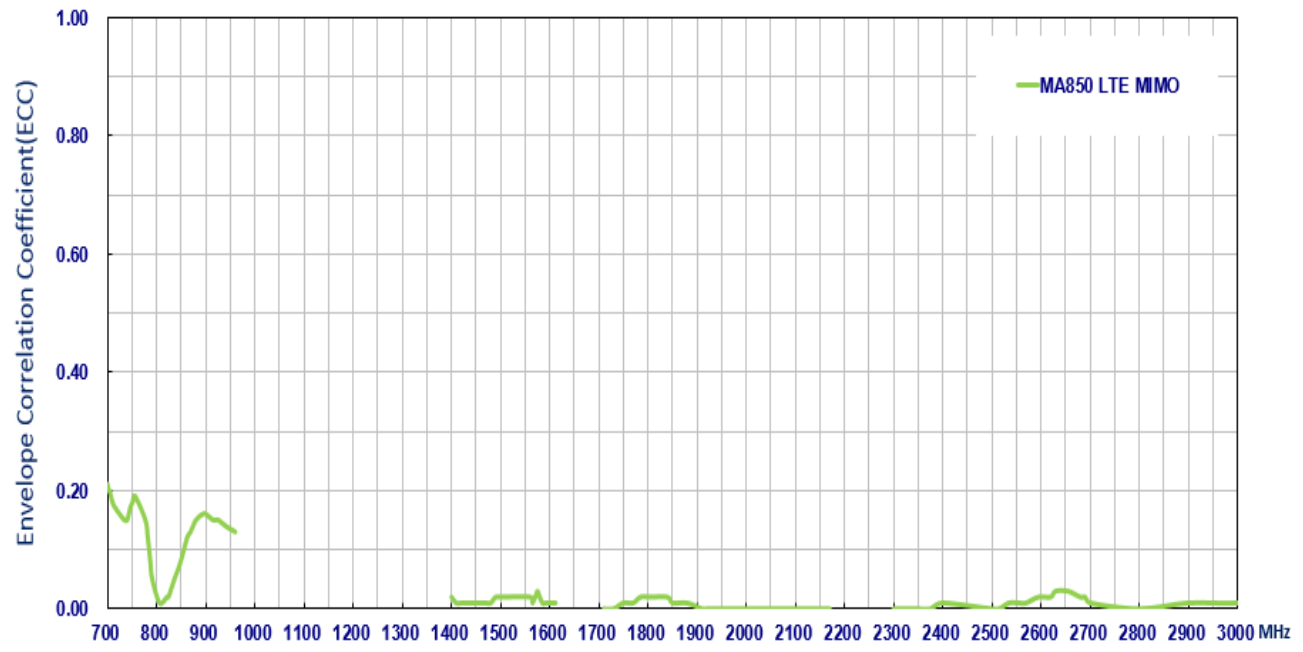

4. Radiation Patterns

4.1 Test Setup

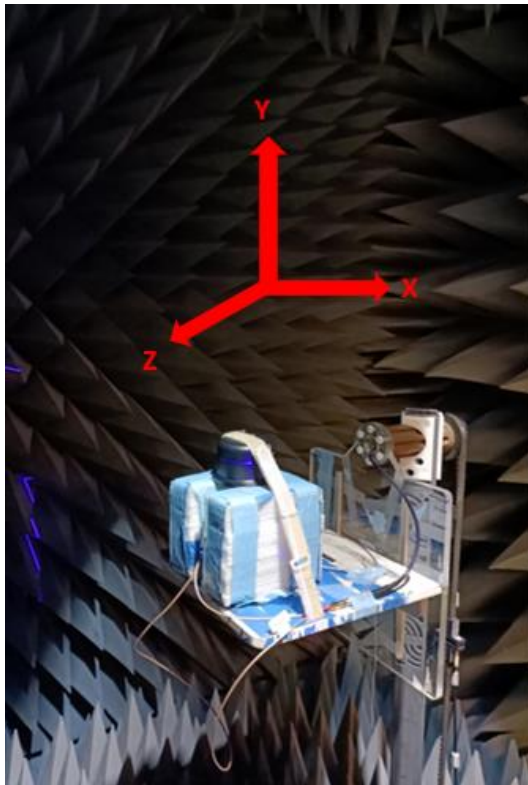
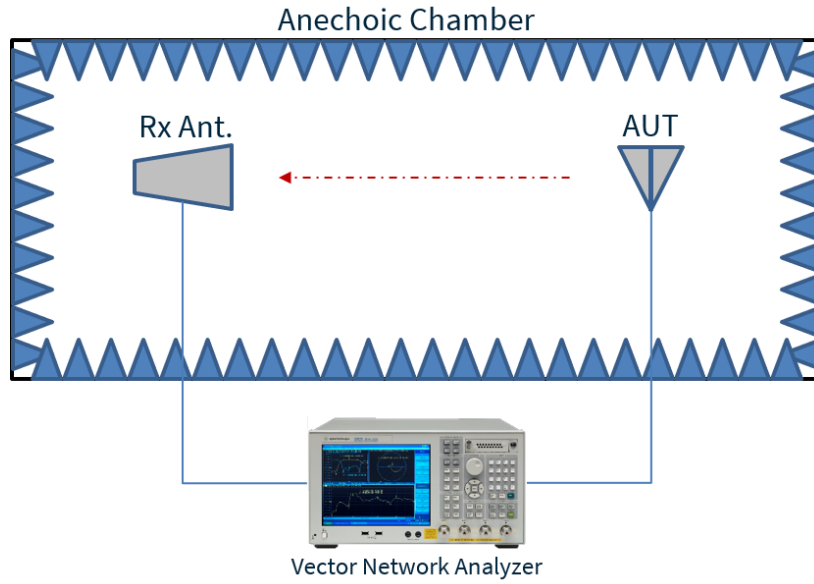

Free Space

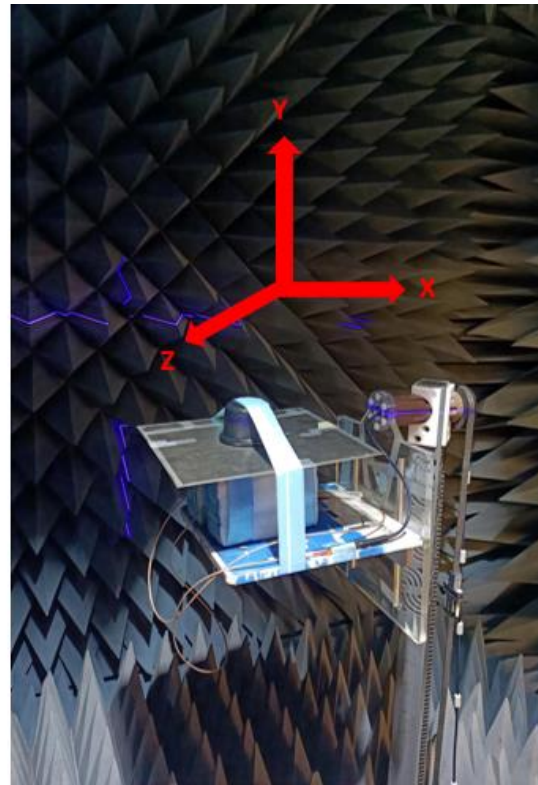

30x30cm Ground Plane

4.2 LTE 1 - 30x30cm Ground Plane Patterns at 650 MHz

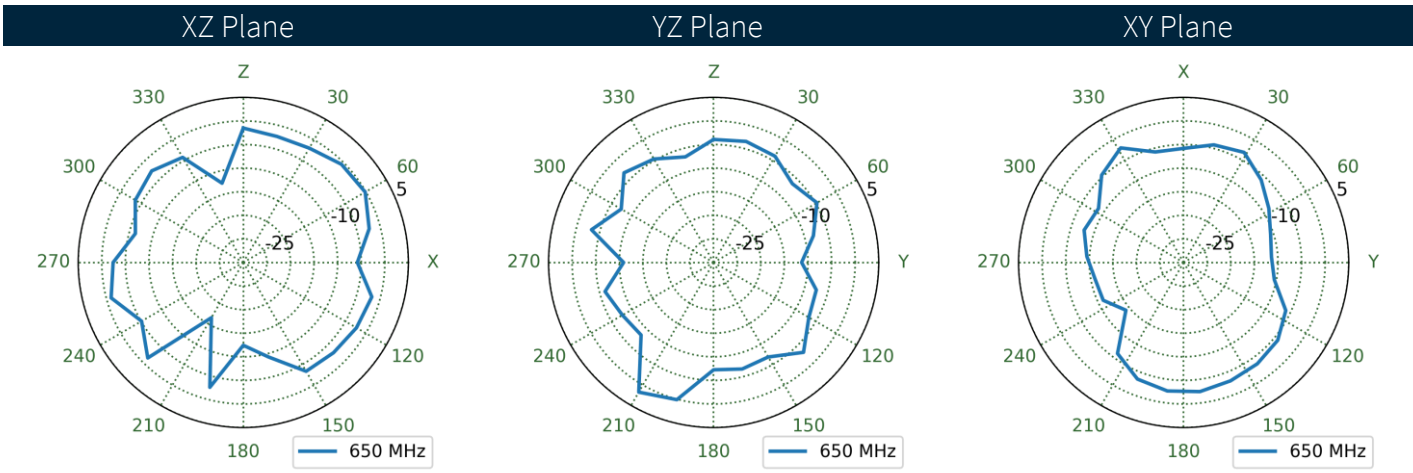
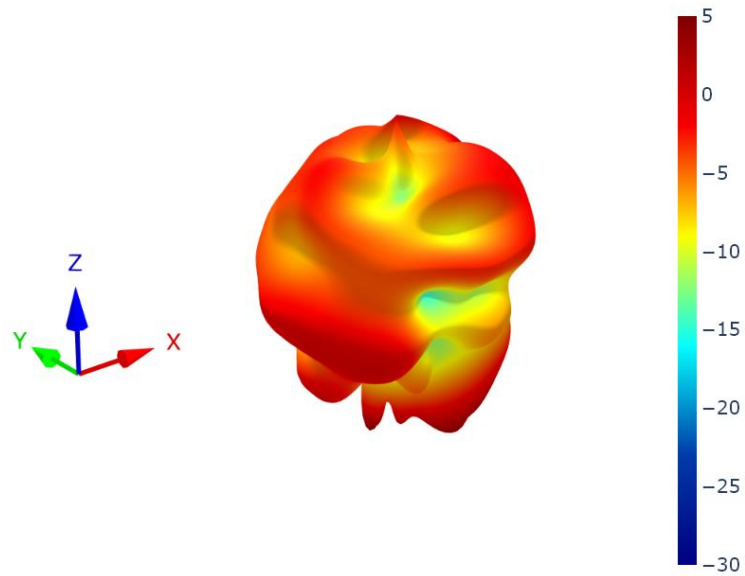

4.3 LTE 2 - 30x30cm Ground Plane Patterns at 650 MHz

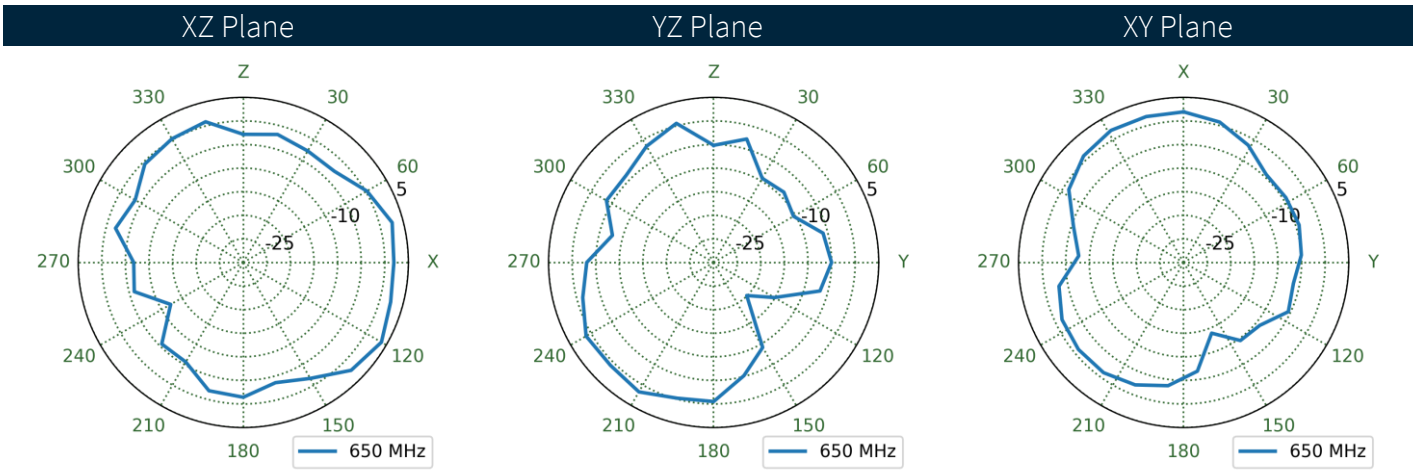
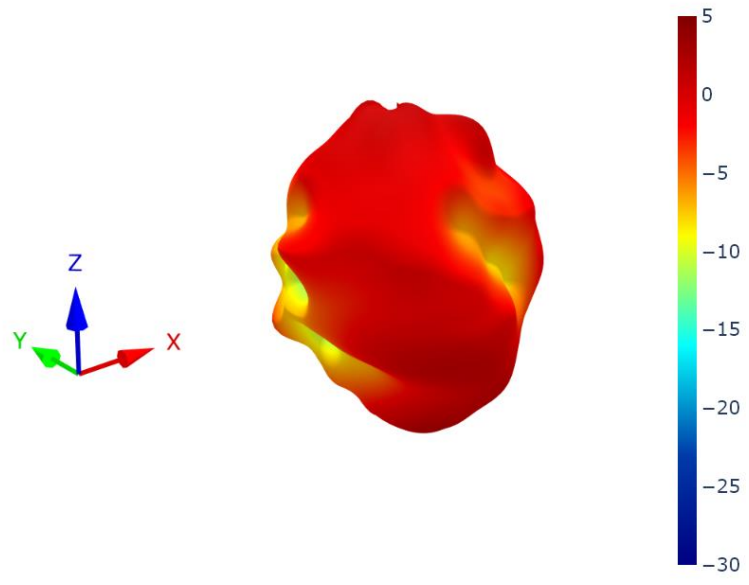

4.4 LTE1 - Free Space Patterns at 650 MHz

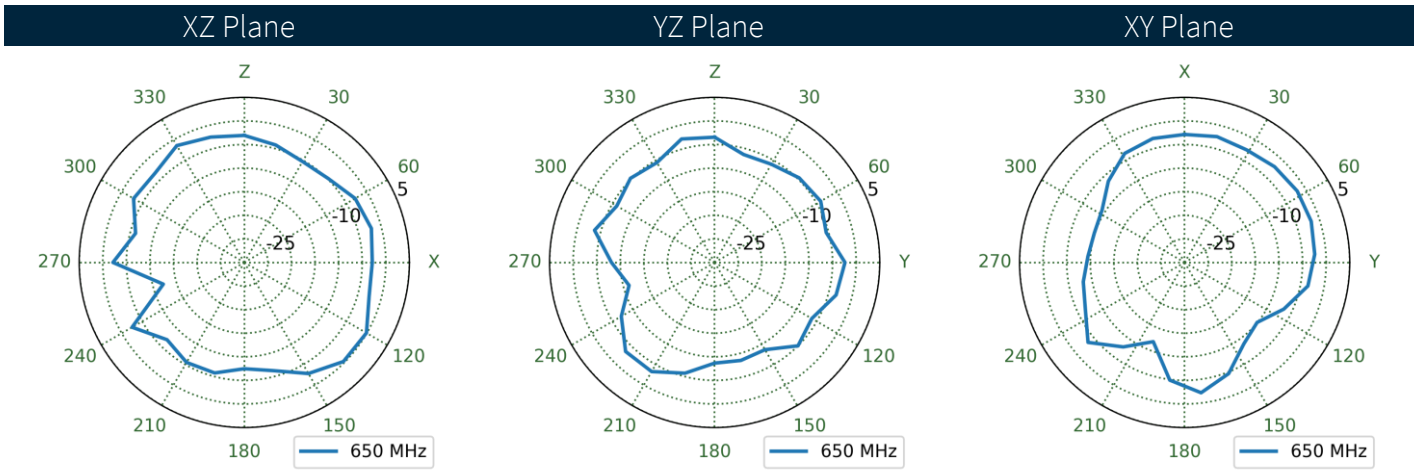
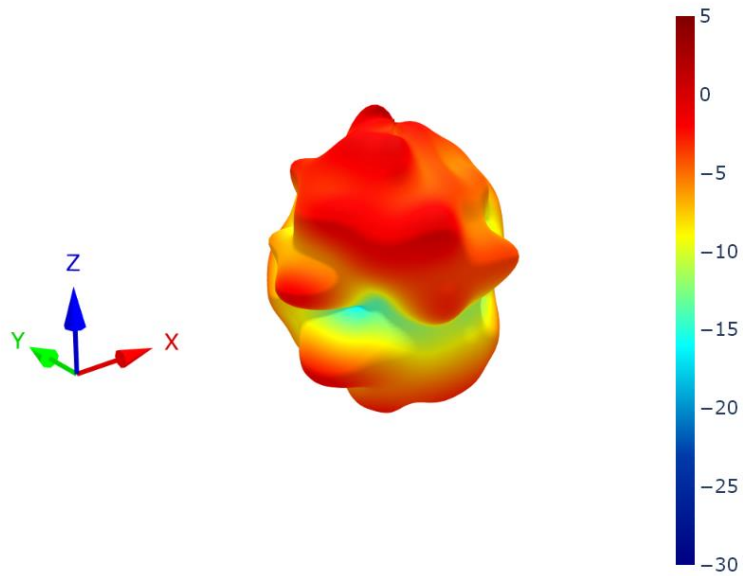

4.5 LTE2 - Free Space Patterns at 650 MHz

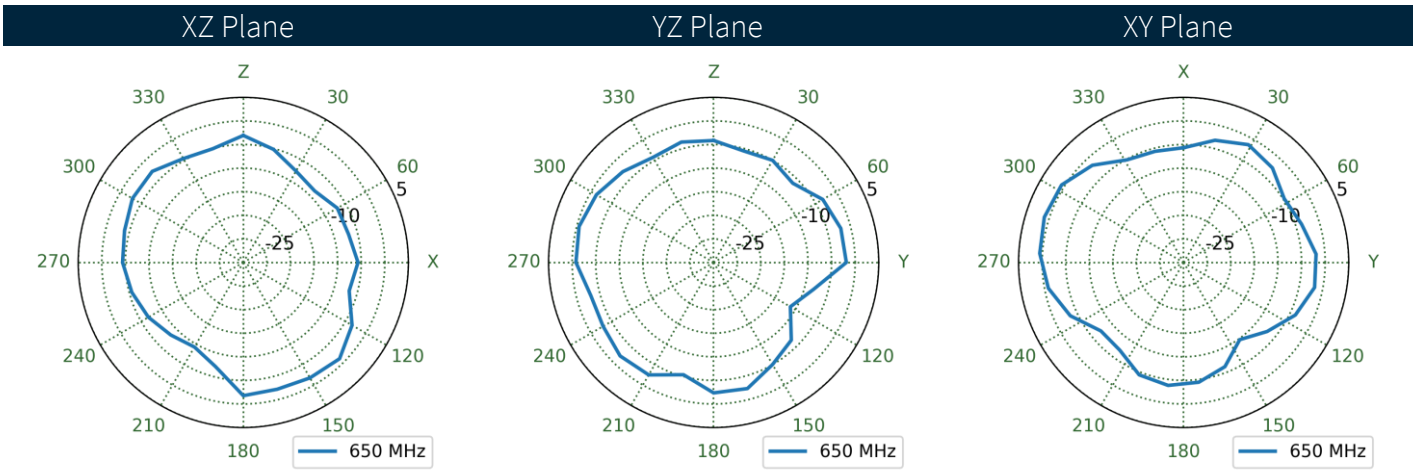
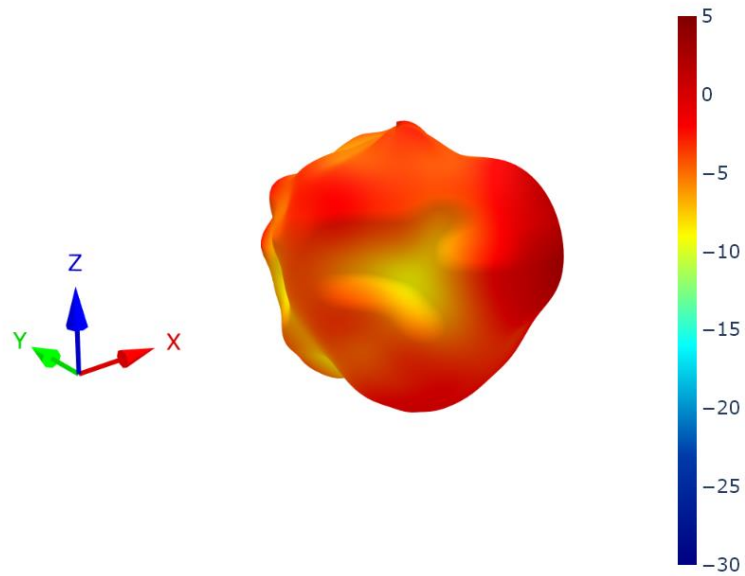

4.6 LTE 1 - 30x30cm Ground Plane Patterns at 750 MHz

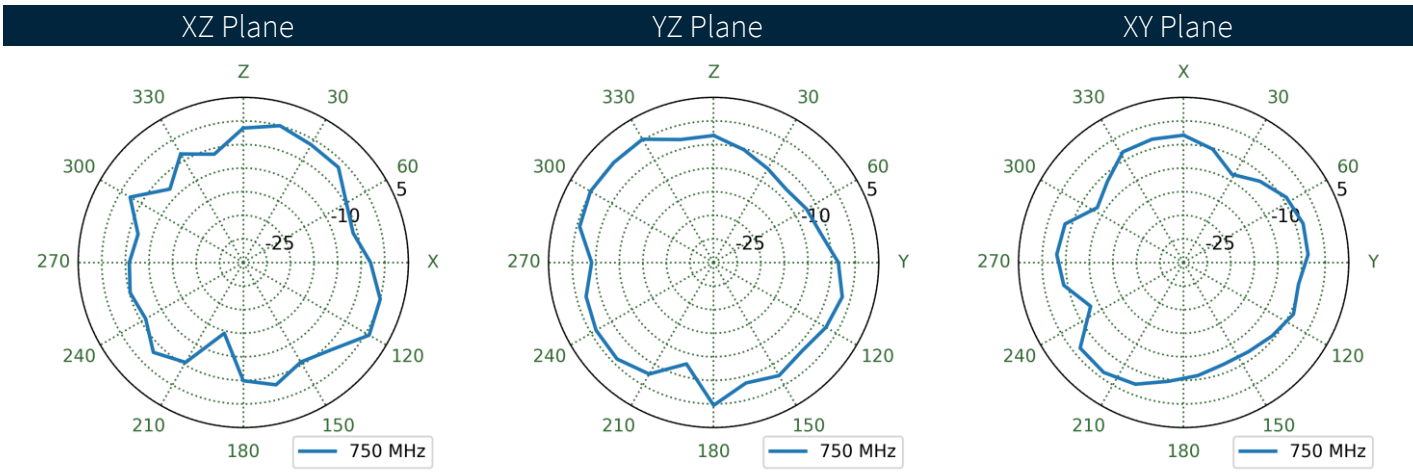
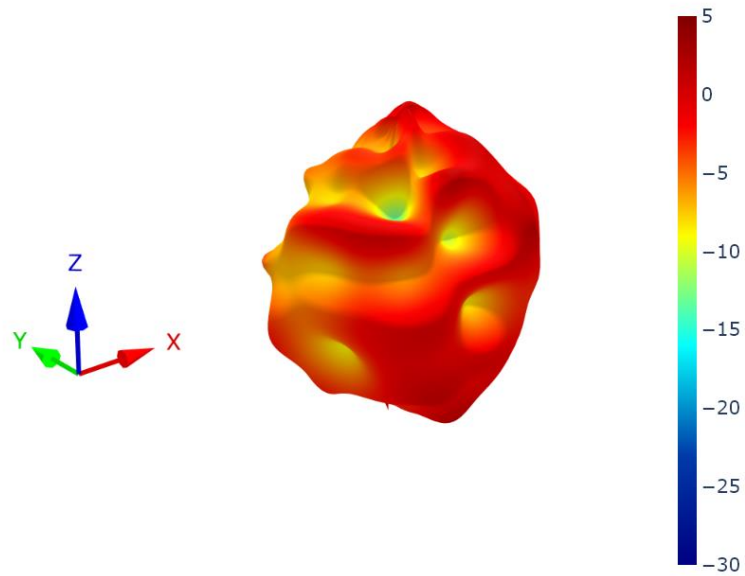

4.7 LTE 2 - 30x30cm Ground Plane Patterns at 750 MHz

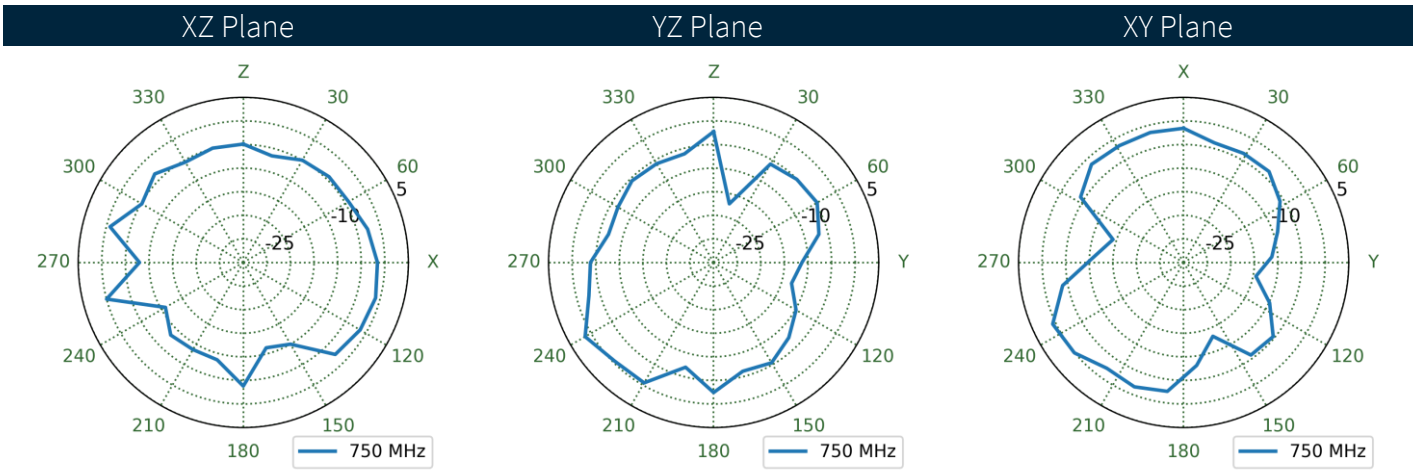
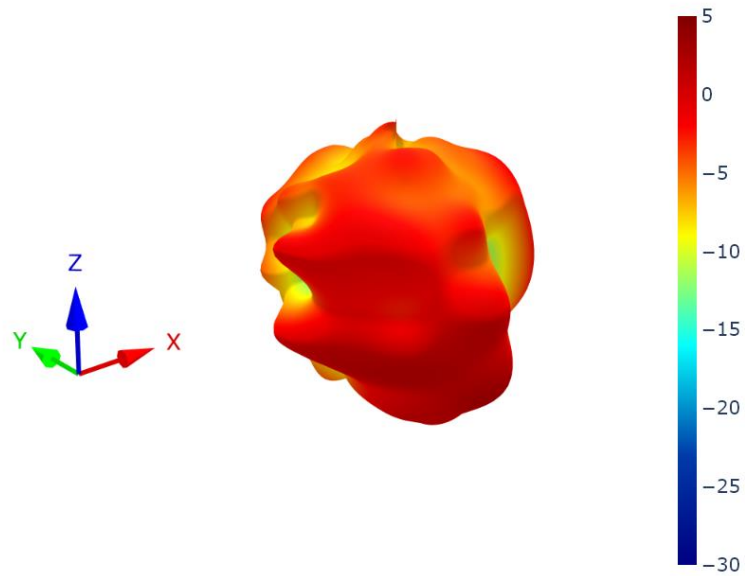

4.8 LTE1 - Free Space Patterns at 750 MHz

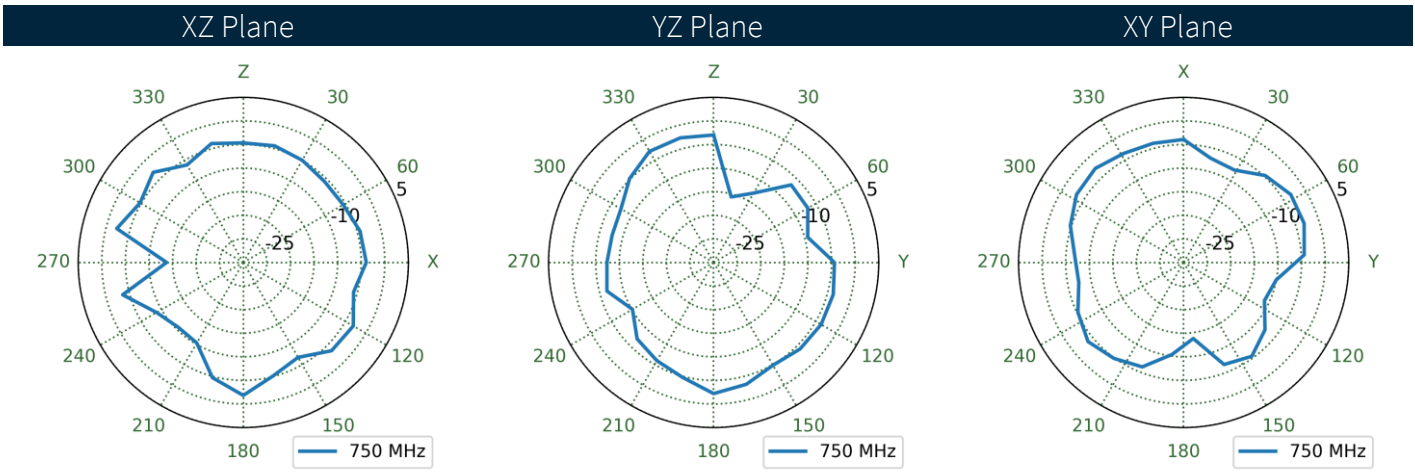
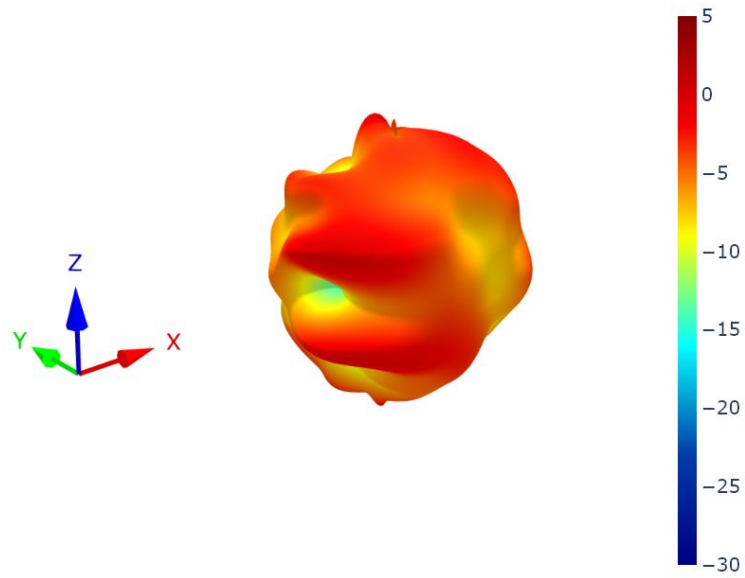

4.9 LTE2 - Free Space Patterns at 750 MHz

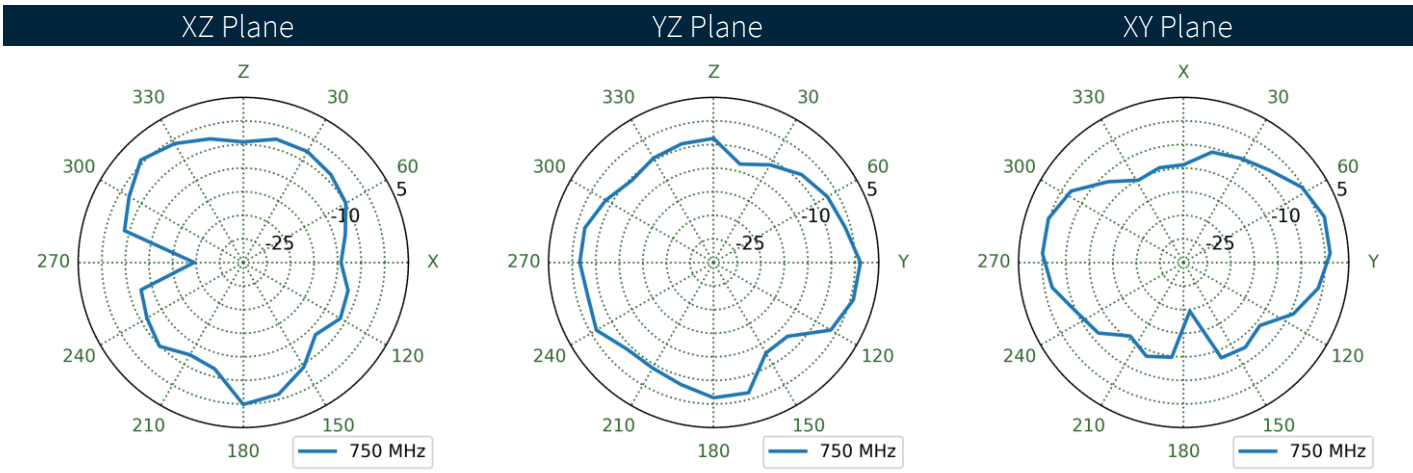
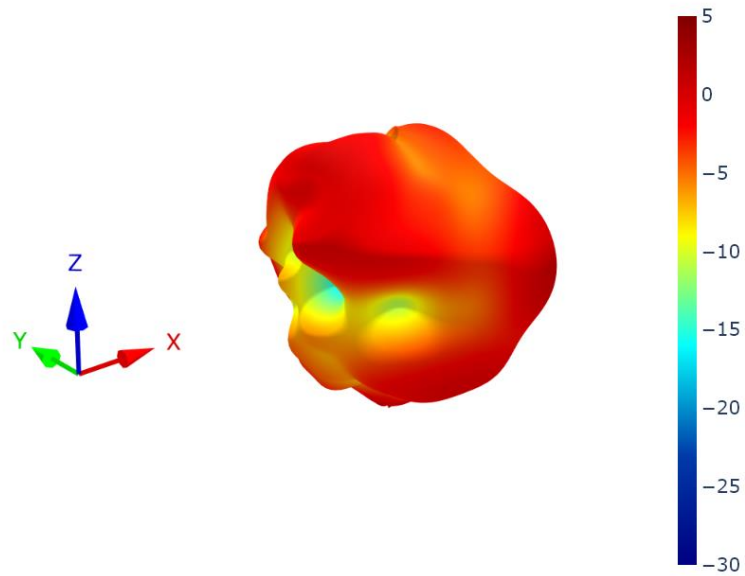

4.10 LTE 1 - 30x30cm Ground Plane Patterns at 890 MHz

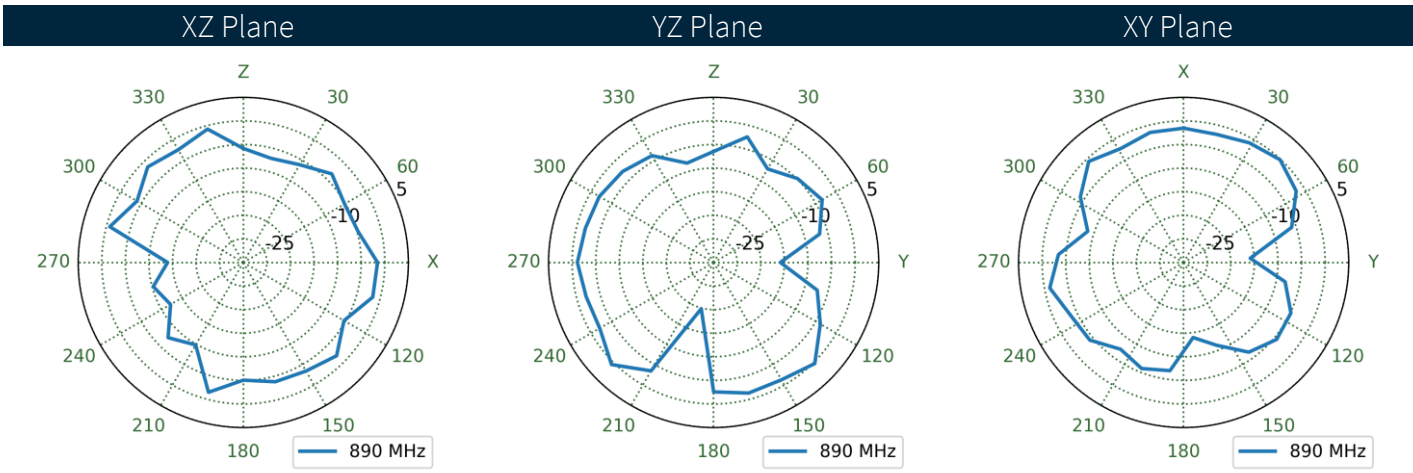
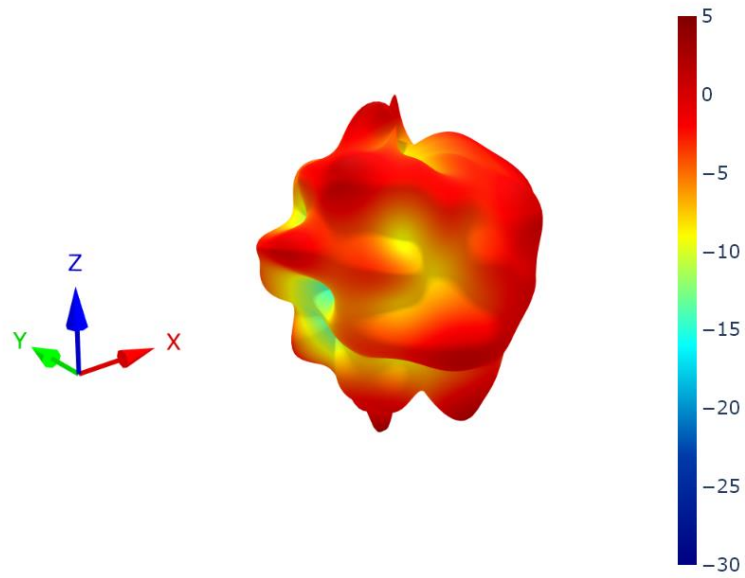

4.11 LTE 2 - 30x30cm Ground Plane Patterns at 890 MHz

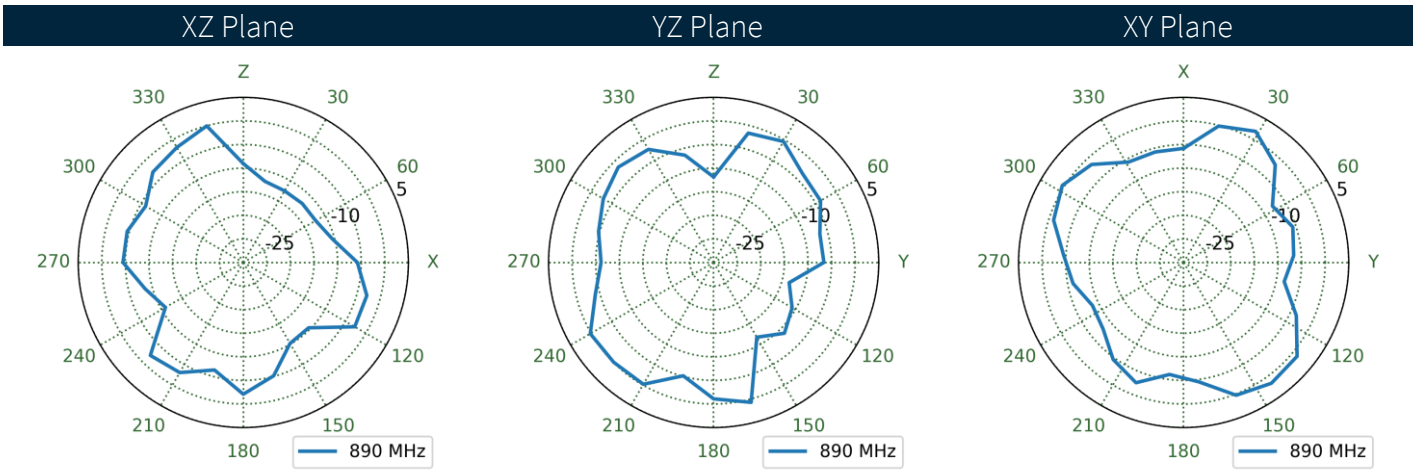
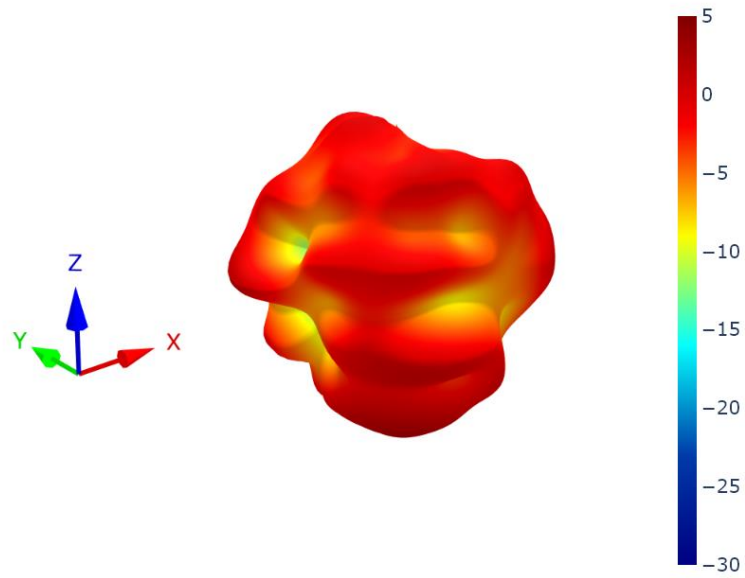

4.12 LTE1 - Free Space Patterns at 890 MHz

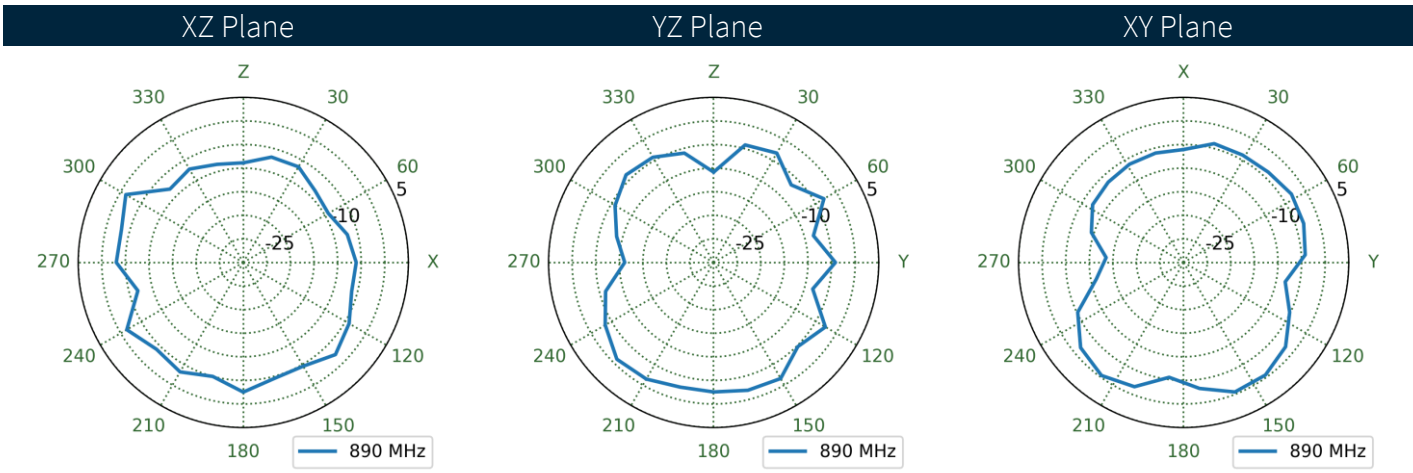
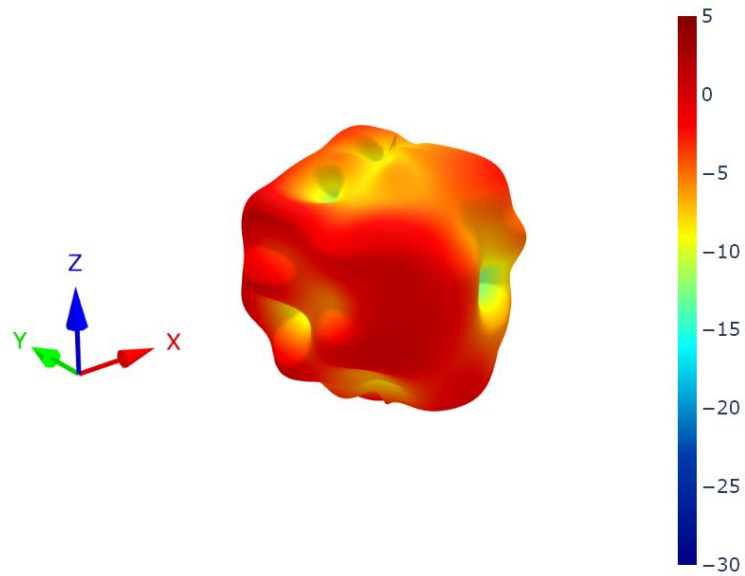

4.13 LTE2 - Free Space Patterns at 890 MHz

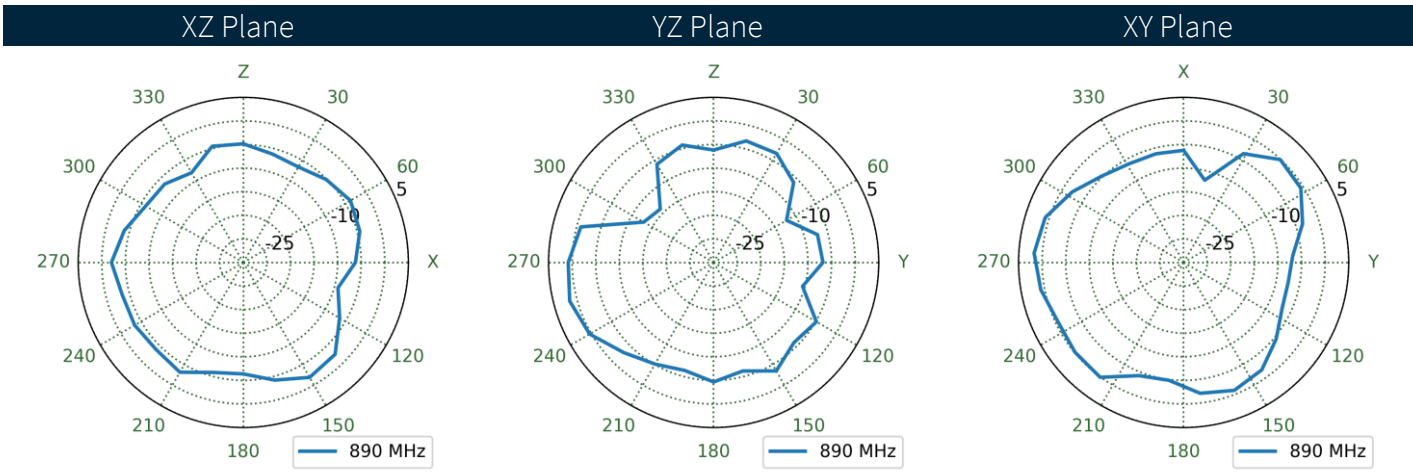
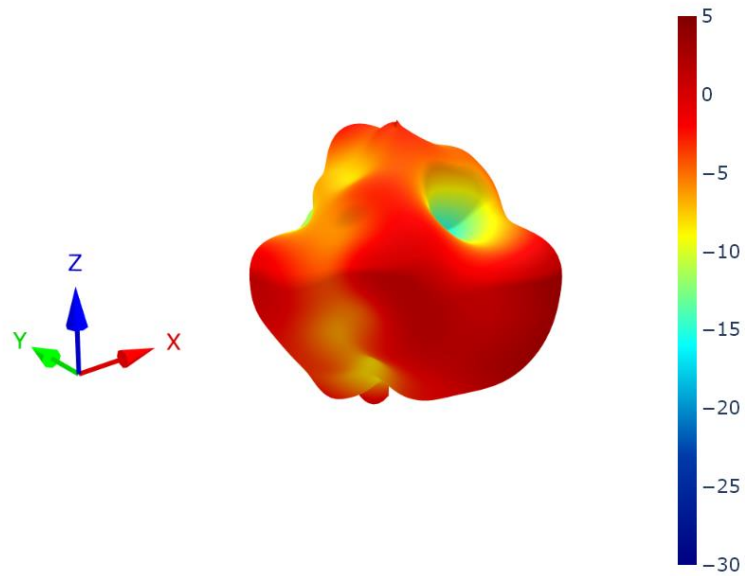

4.14 LTE 1 - 30x30cm Ground Plane Patterns at 1475 MHz

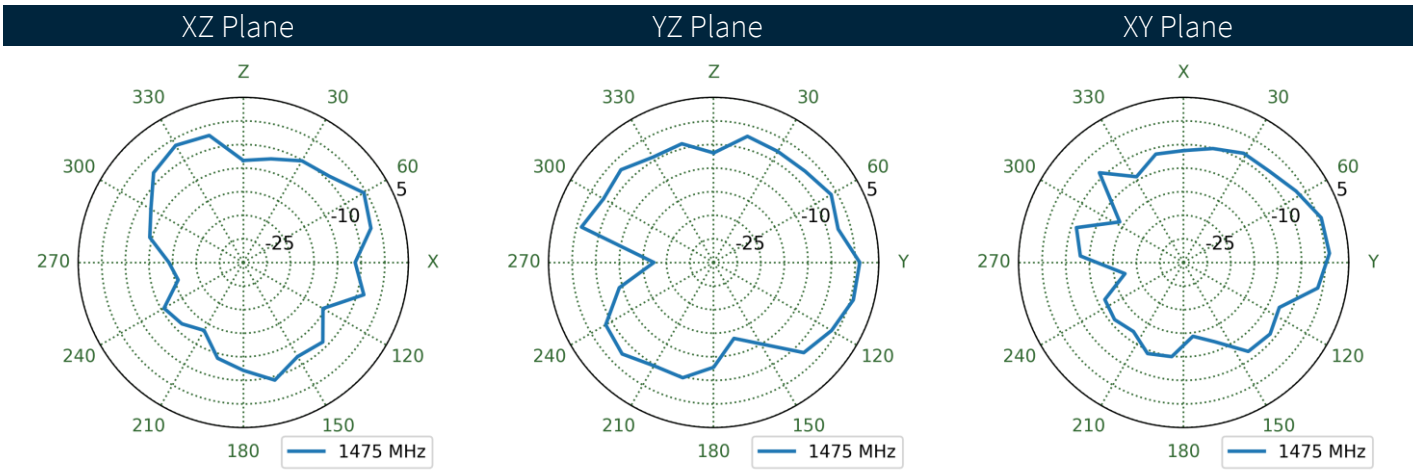
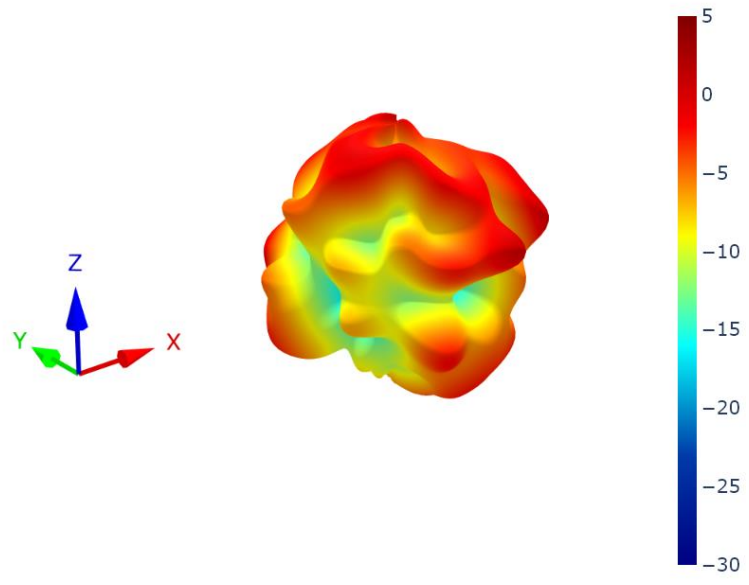

4.15 LTE 2 - 30x30cm Ground Plane Patterns at 1475 MHz

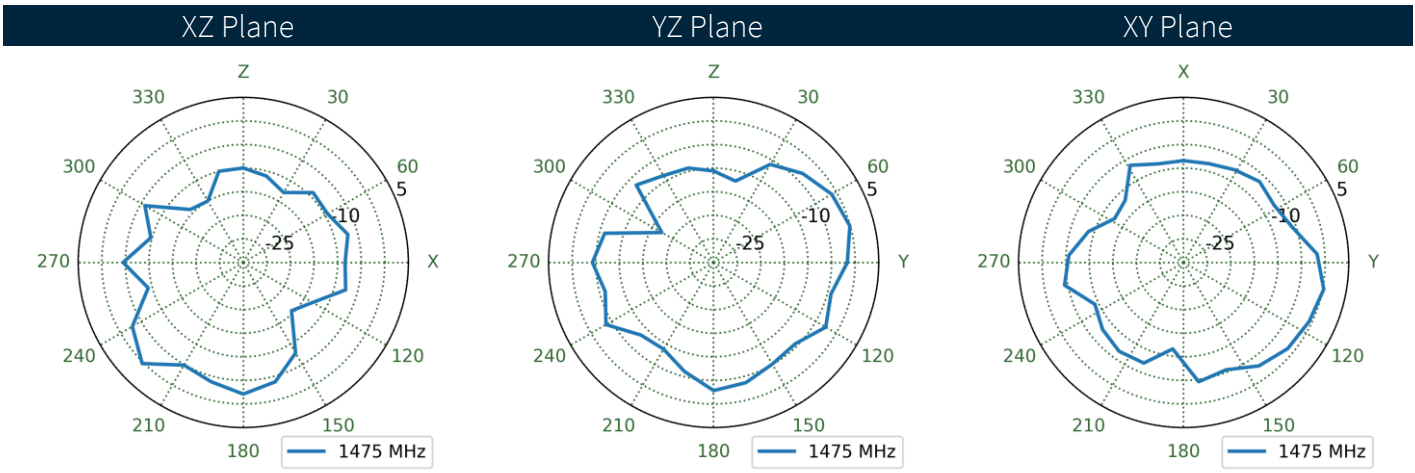
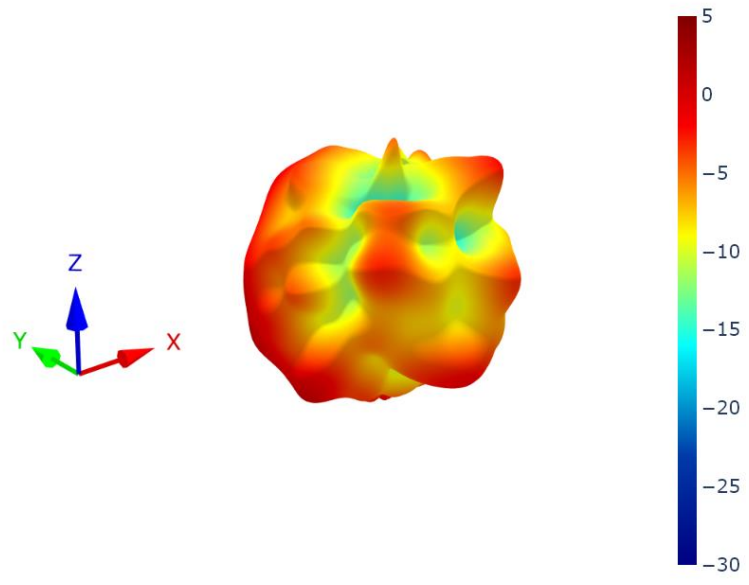

4.16 LTE1 - Free Space Patterns at 1475 MHz

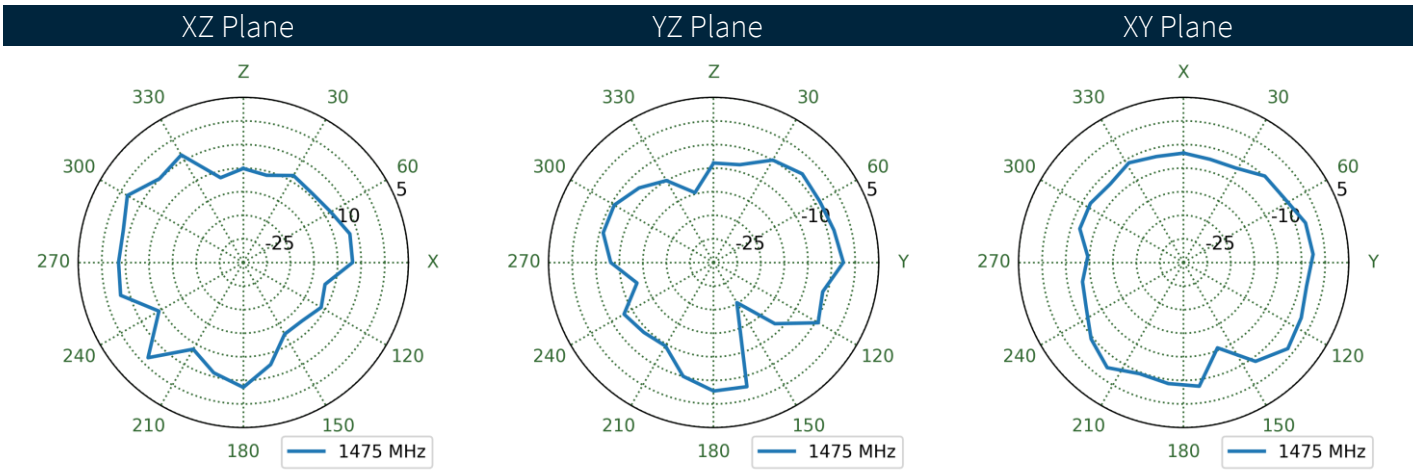
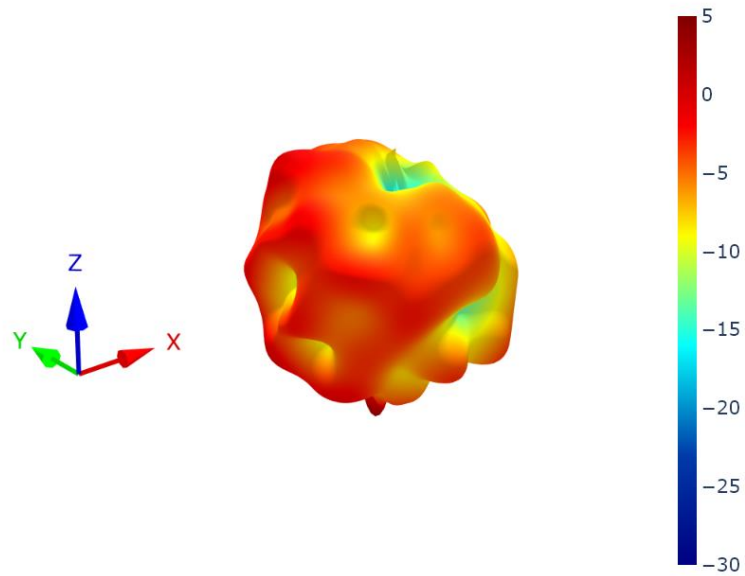

4.17 LTE2 - Free Space Patterns at 1475 MHz

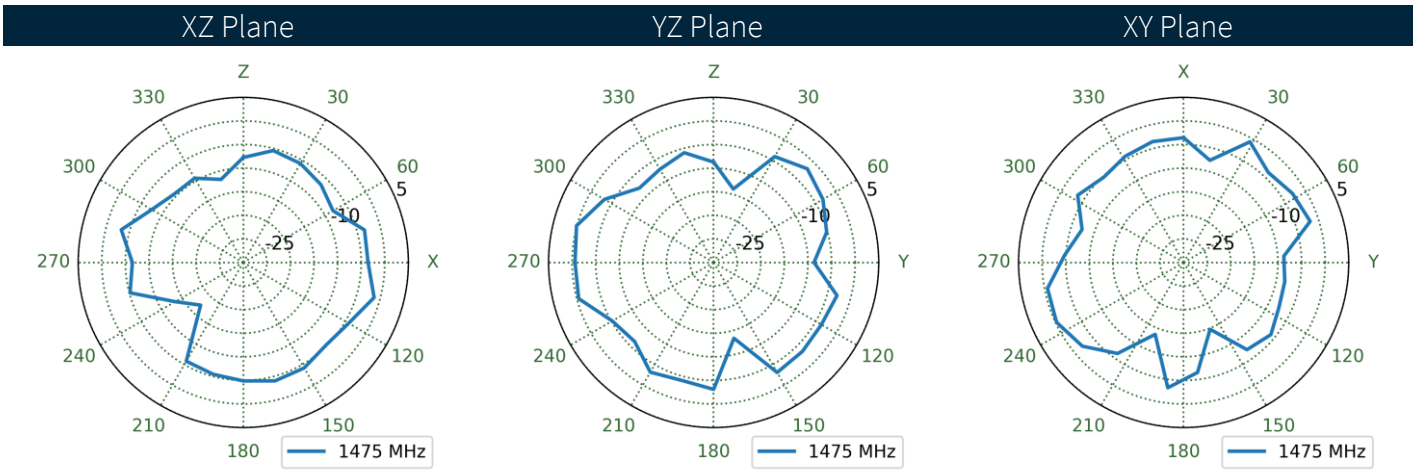
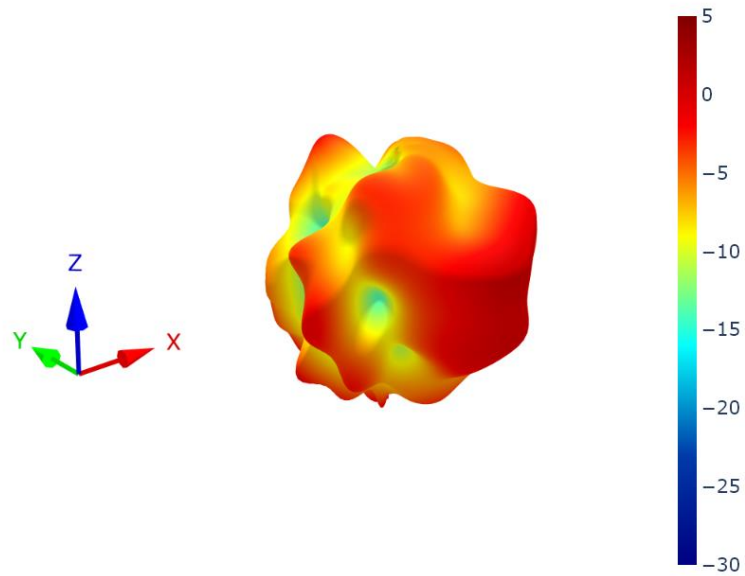

4.18 LTE 1 - 30x30cm Ground Plane Patterns at 1955 MHz

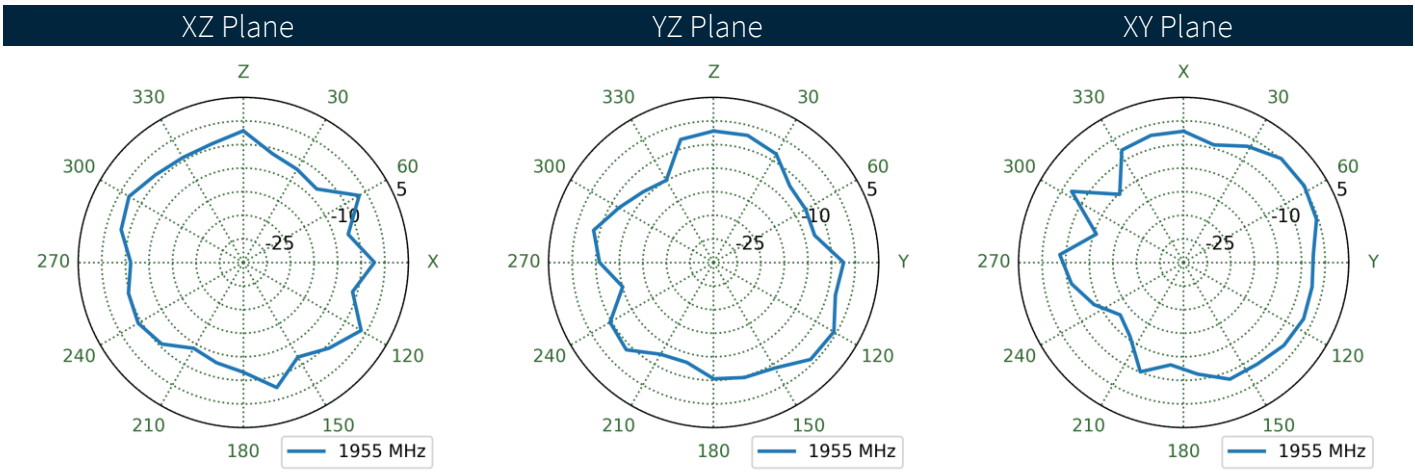
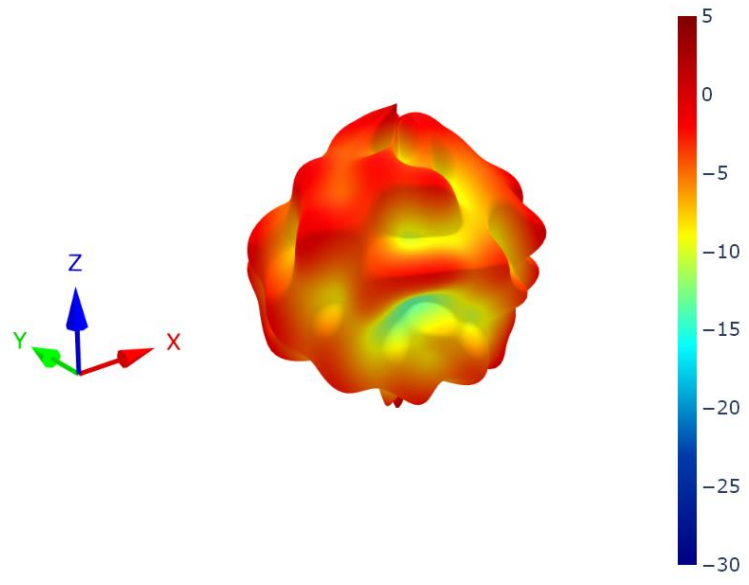

4.19 LTE 2 - 30x30cm Ground Plane Patterns at 1955 MHz

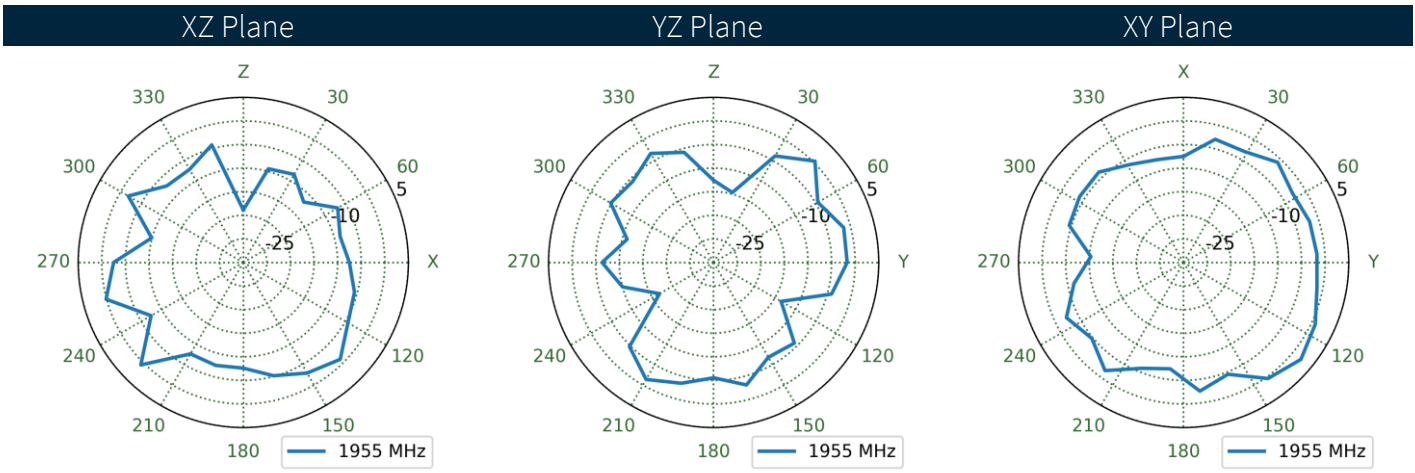
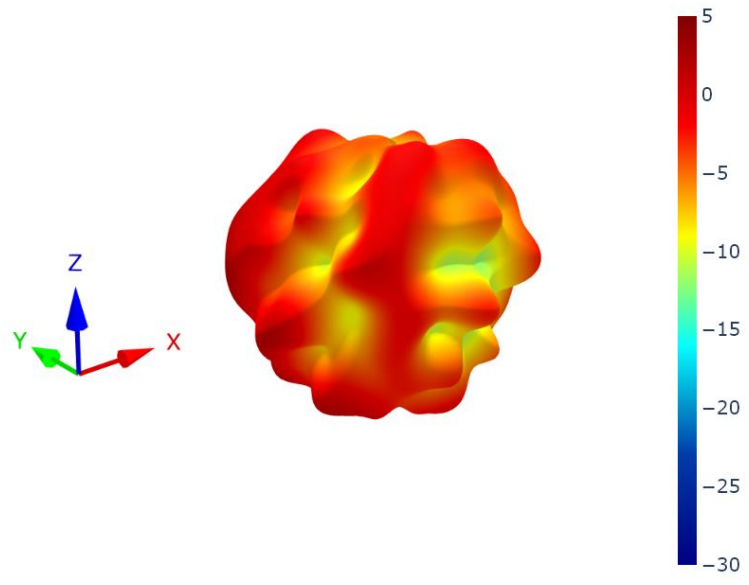

4.20 LTE1 - Free Space Patterns at 1955 MHz

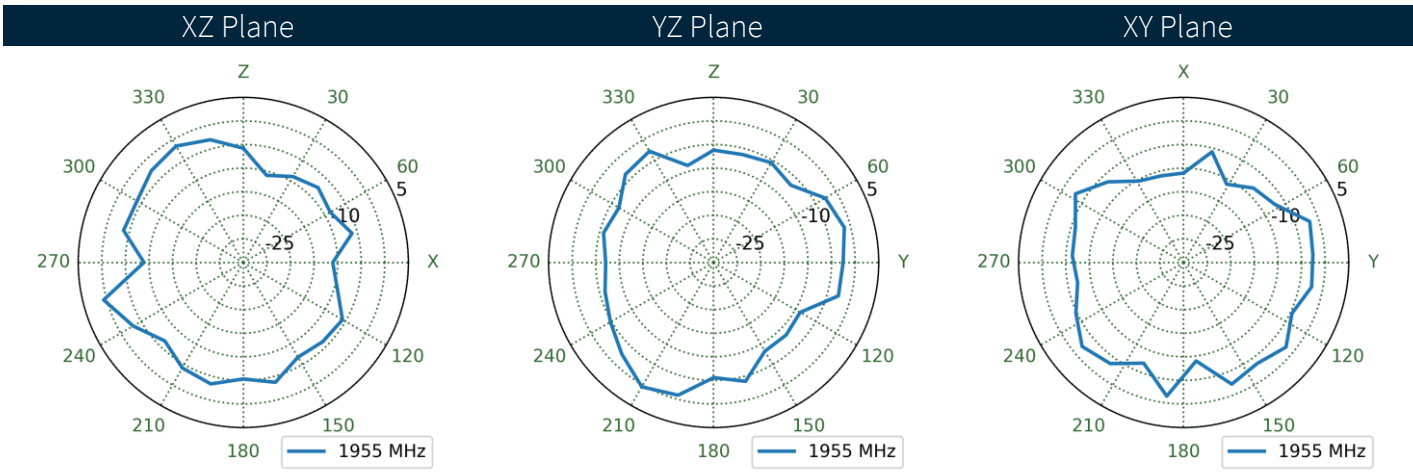
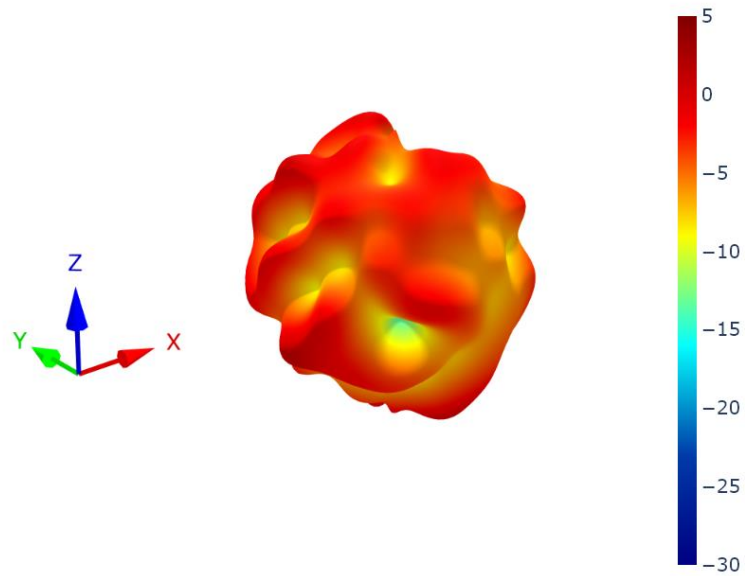

4.21 LTE2 - Free Space Patterns at 1955 MHz

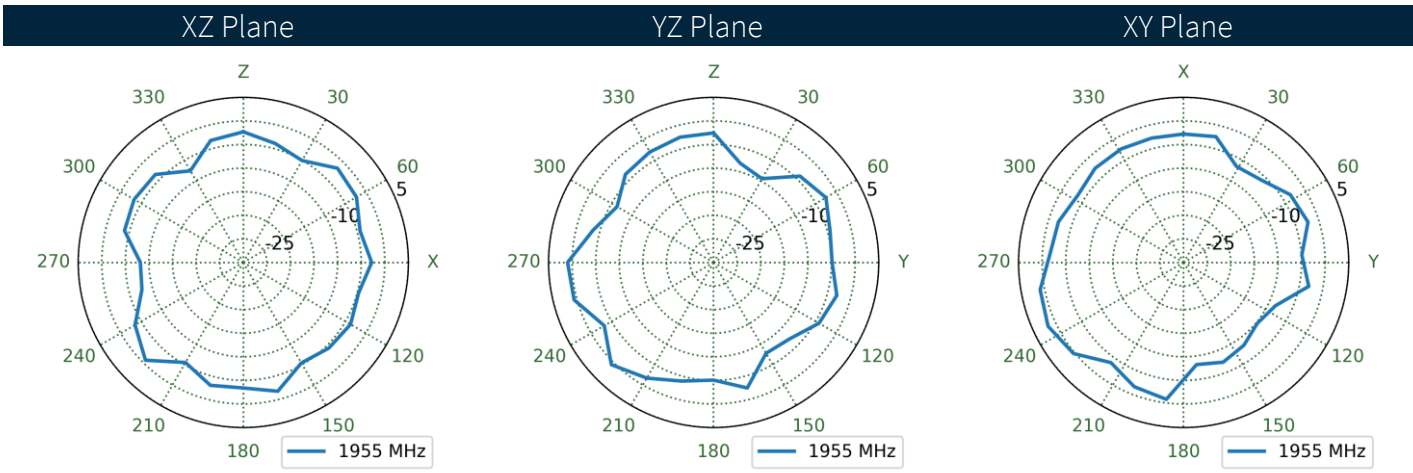
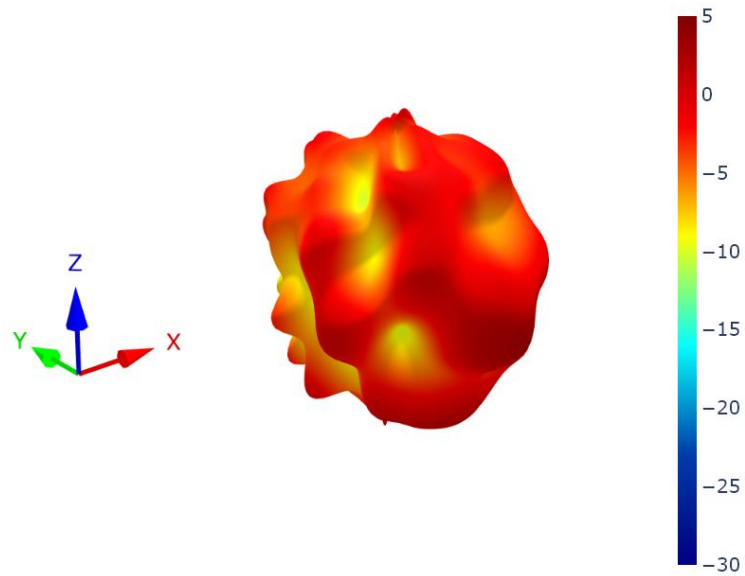

4.22 LTE 1 - 30x30cm Ground Plane Patterns at 2495 MHz

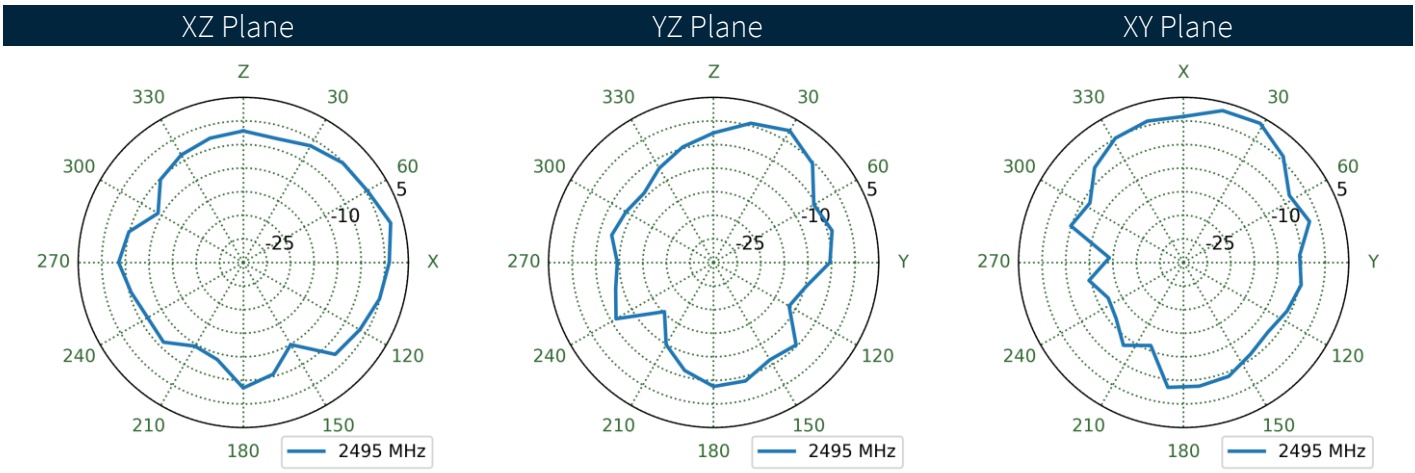
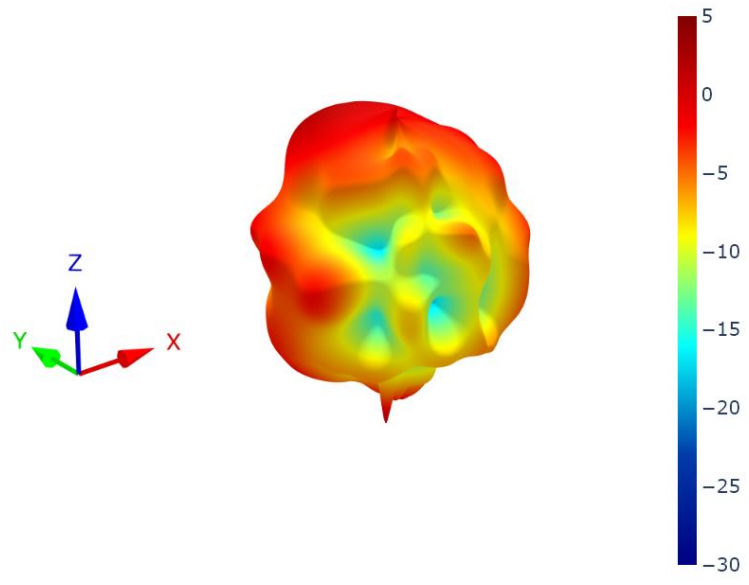

4.23 LTE 2 - 30x30cm Ground Plane Patterns at 2495 MHz

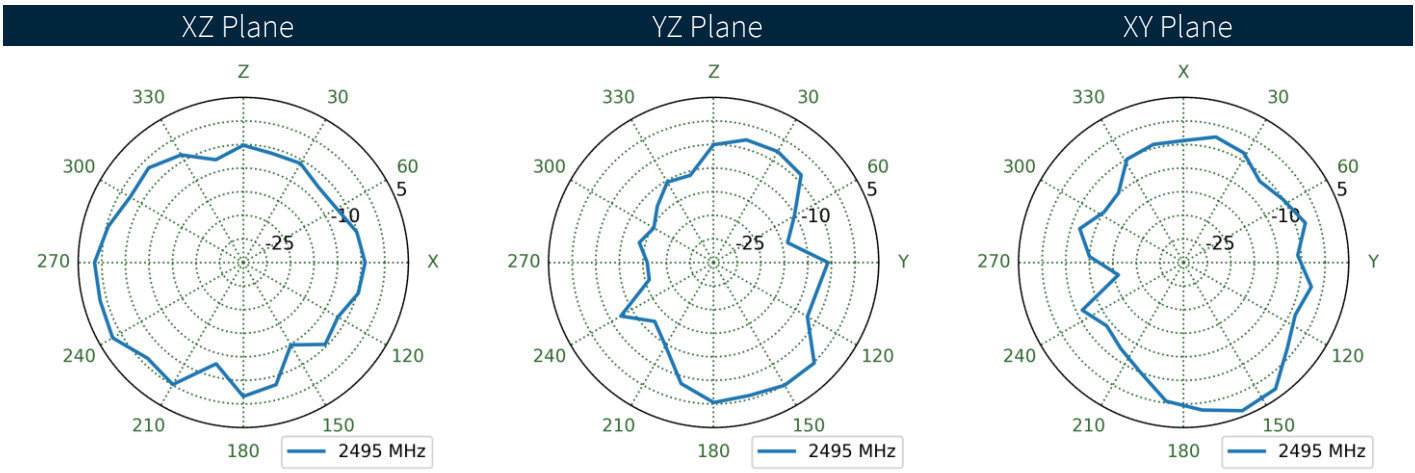
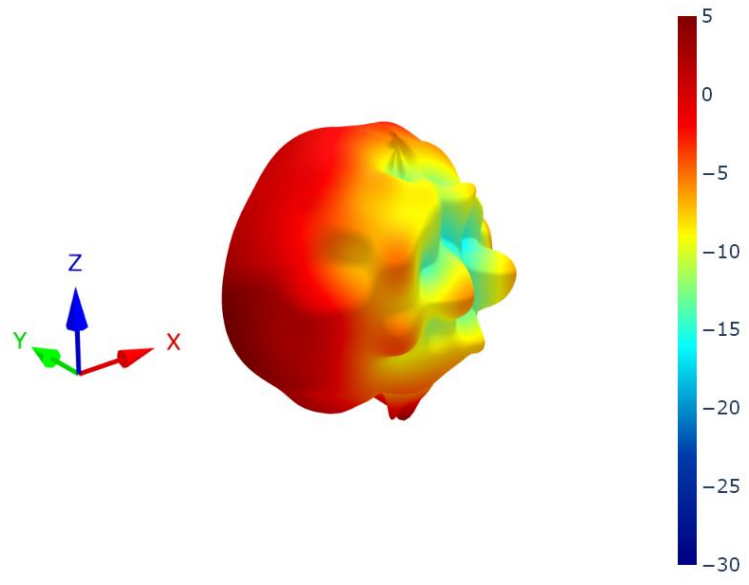

4.24 LTE1 - Free Space Patterns at 2495 MHz

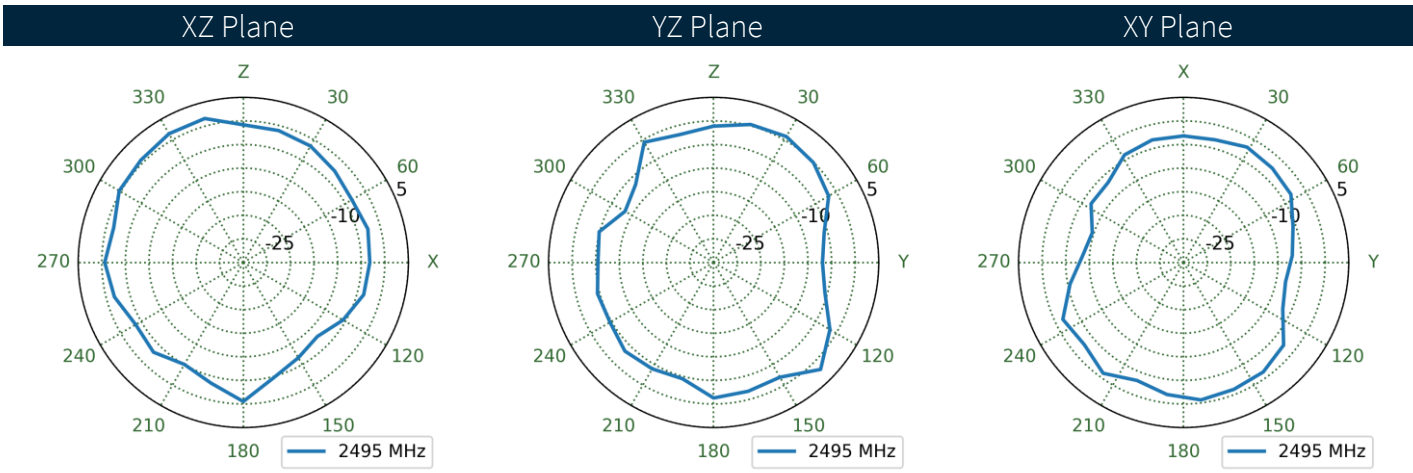
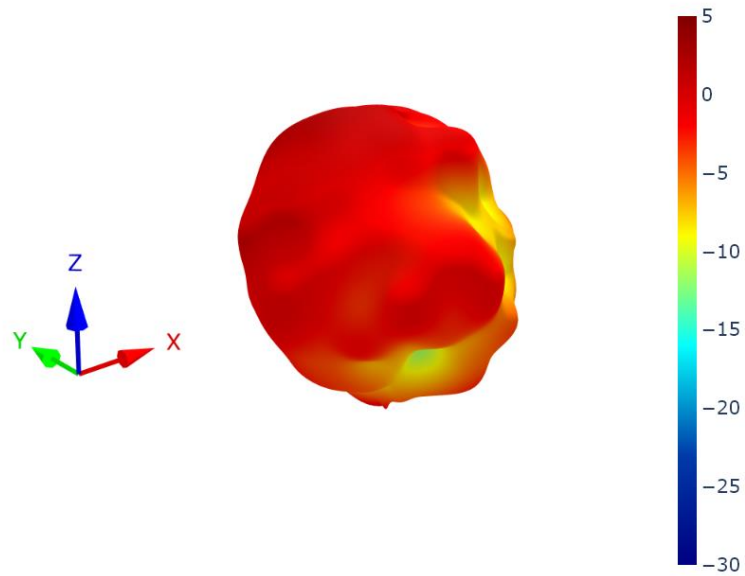

4.25 LTE2 - Free Space Patterns at 2495 MHz

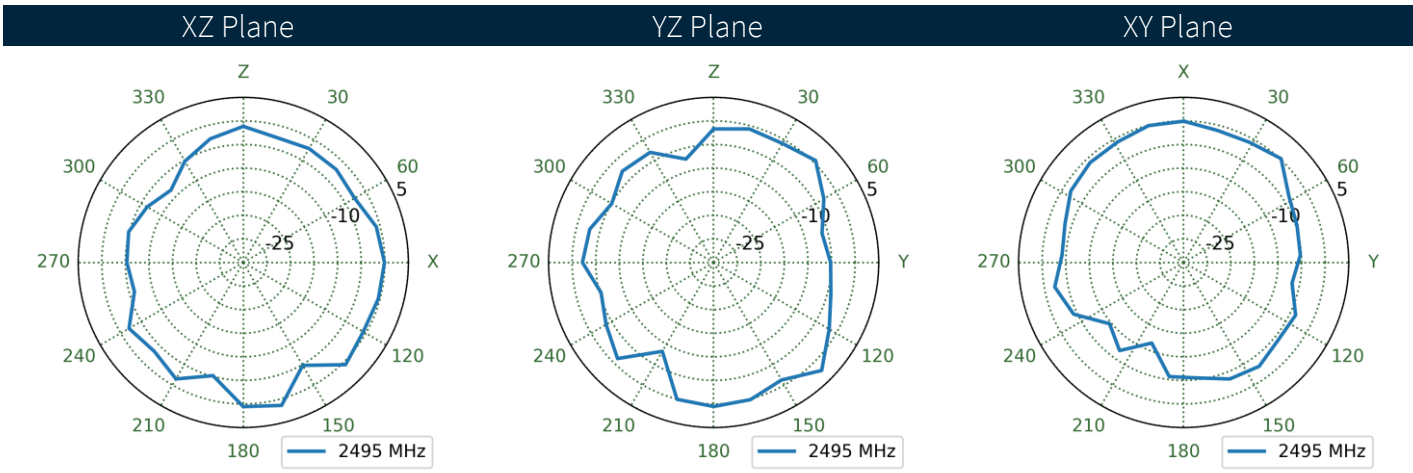
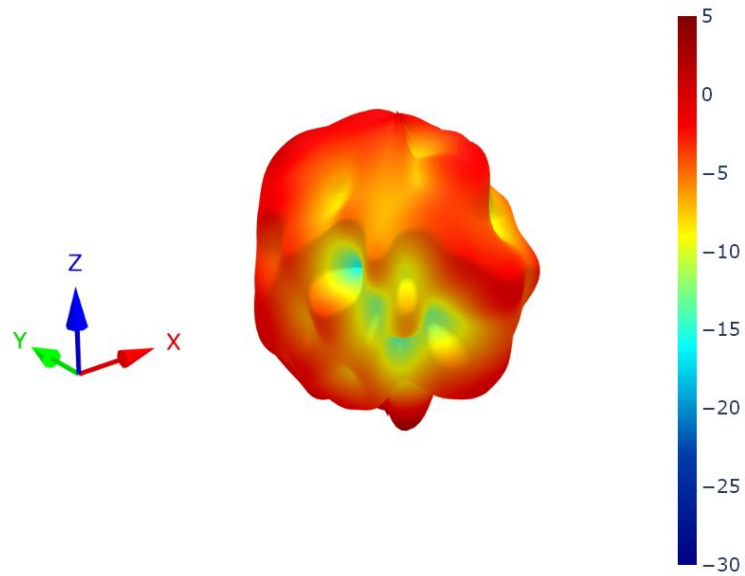

4.26 LTE 1 - 30x30cm Ground Plane Patterns at 4150 MHz

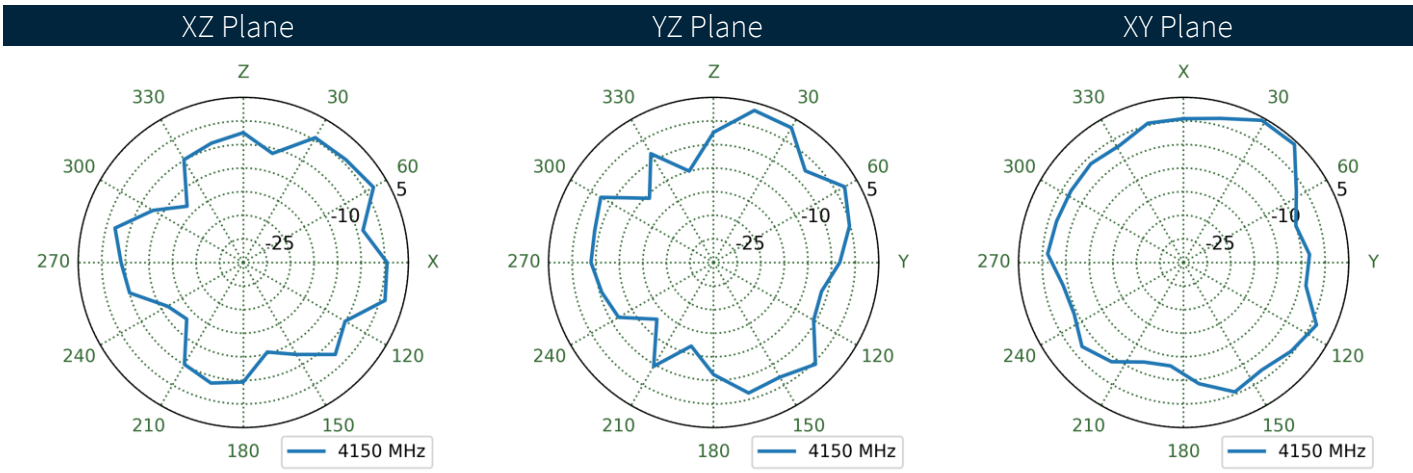
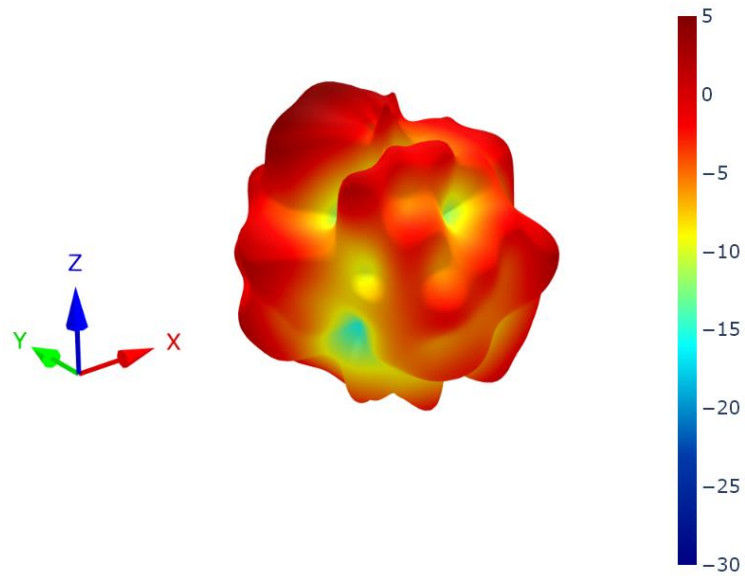

4.27 LTE 2 - 30x30cm Ground Plane Patterns at 4150 MHz

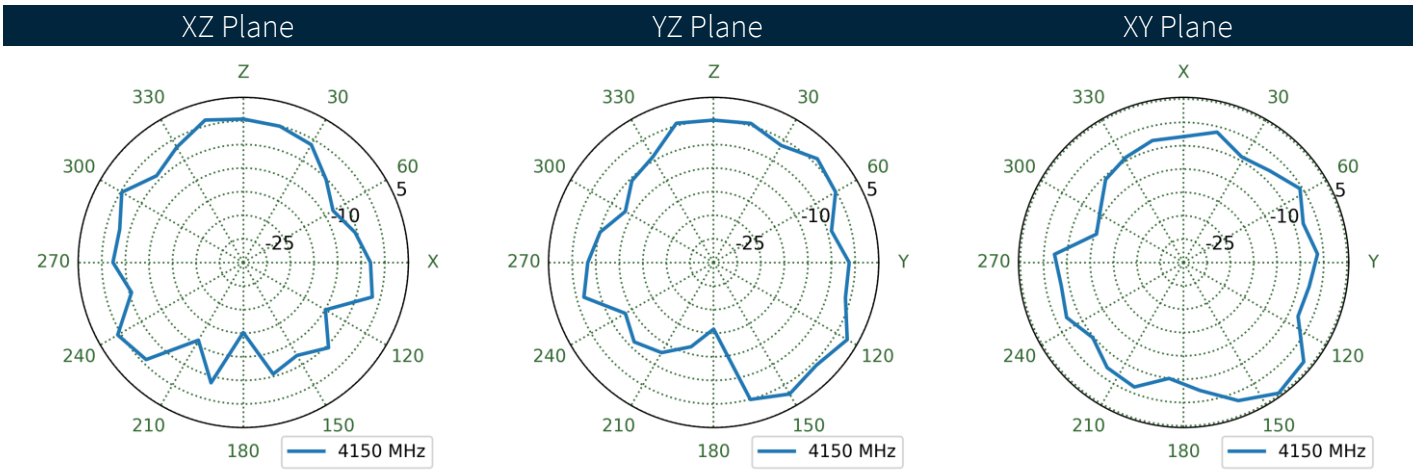
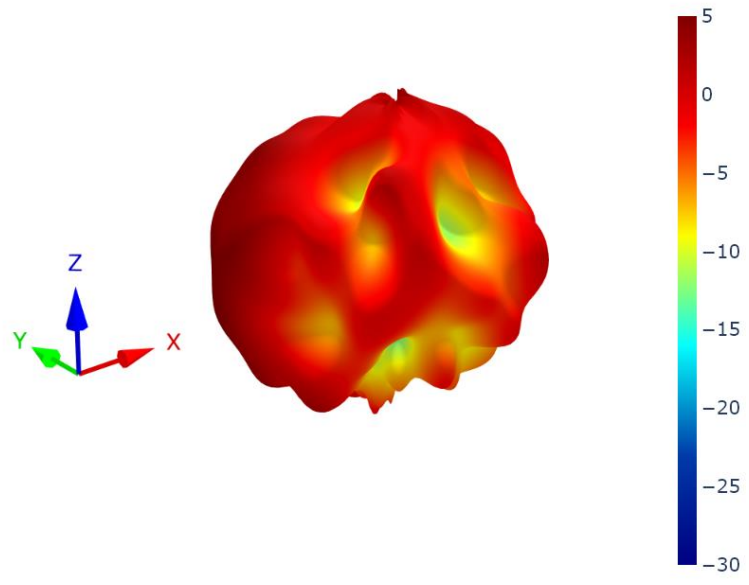

4.28 LTE1 - Free Space Patterns at 4150 MHz

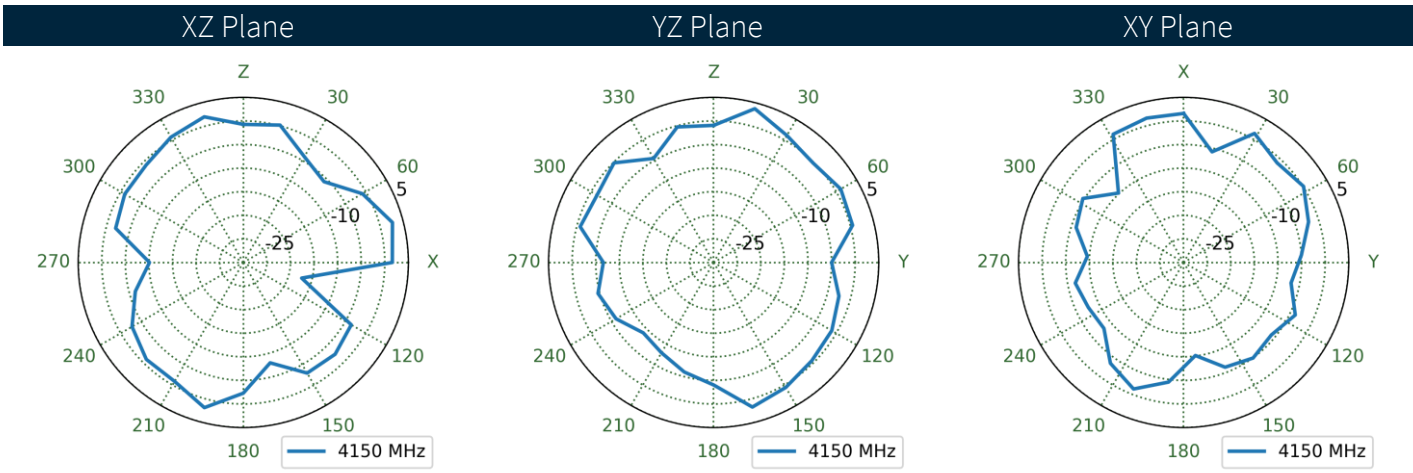
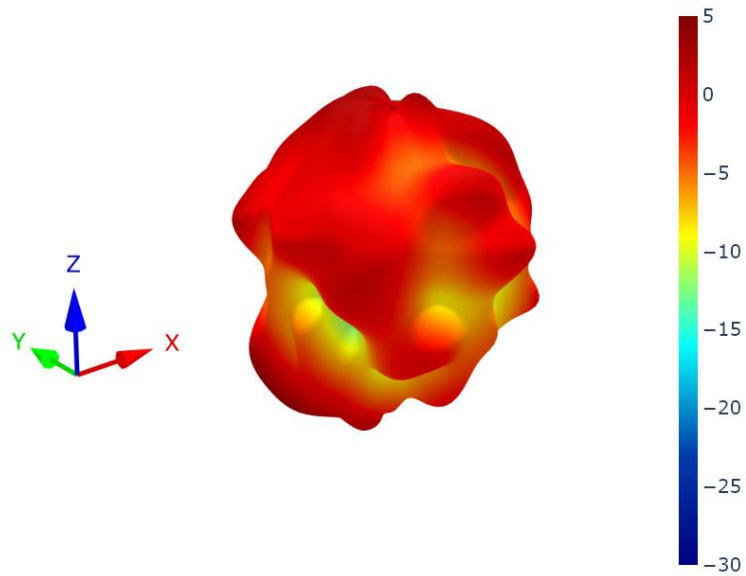

4.29 LTE2 - Free Space Patterns at 4150 MHz

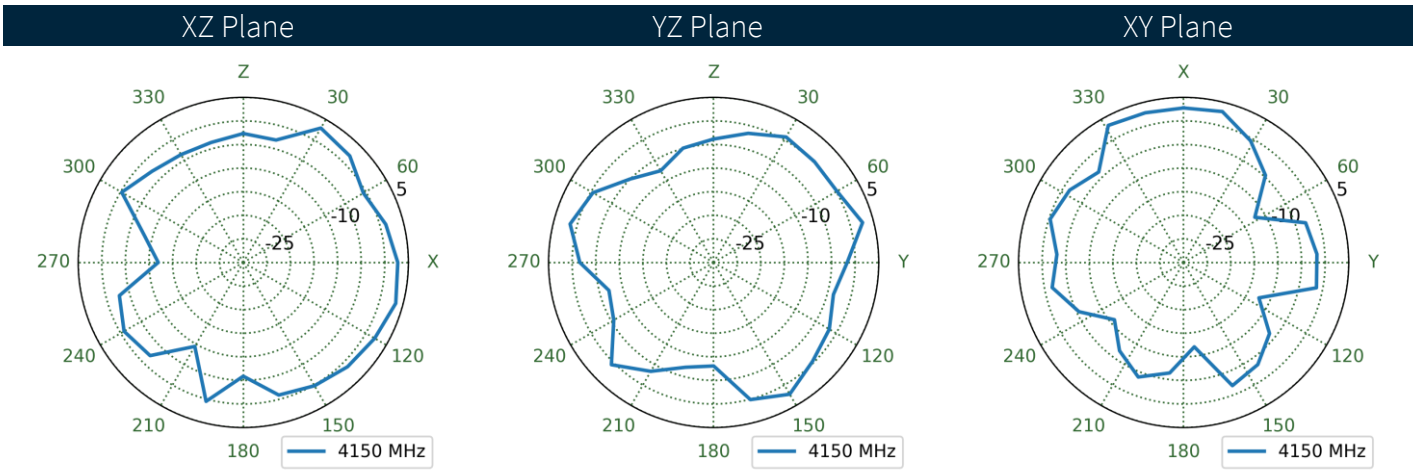
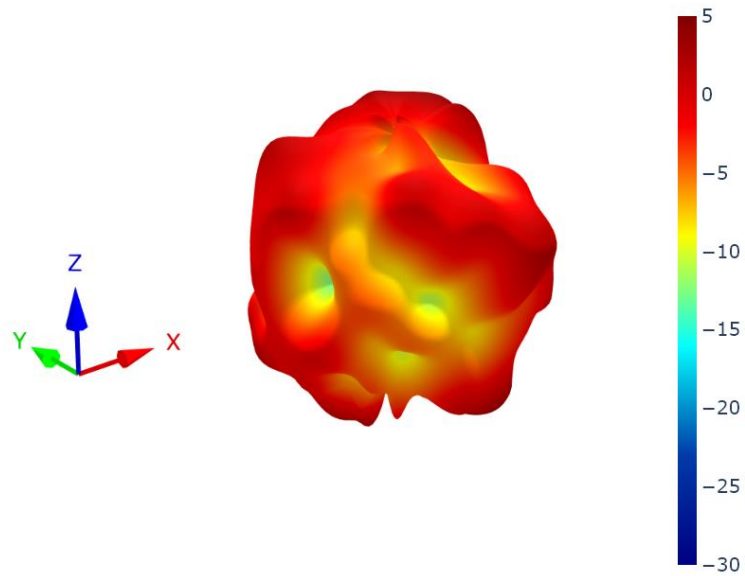

4.30 LTE 1 - 30x30cm Ground Plane Patterns at 5550 MHz

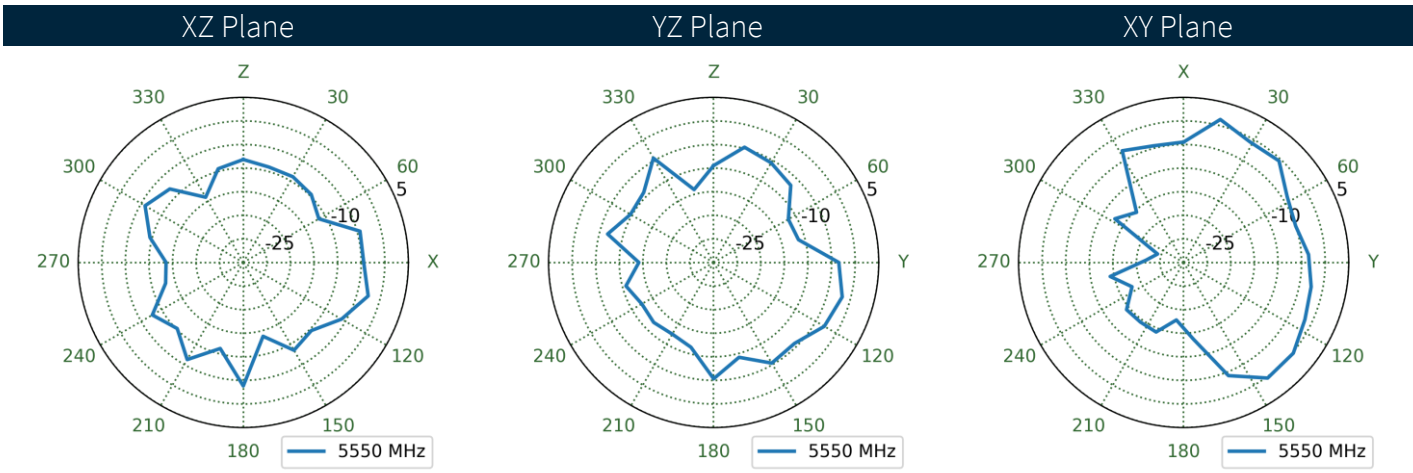
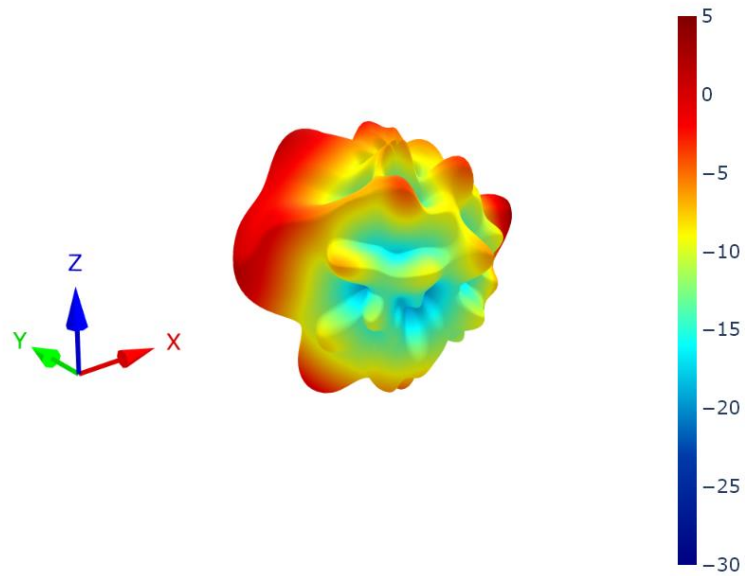

4.31 LTE 2 - 30x30cm Ground Plane Patterns at 5550 MHz

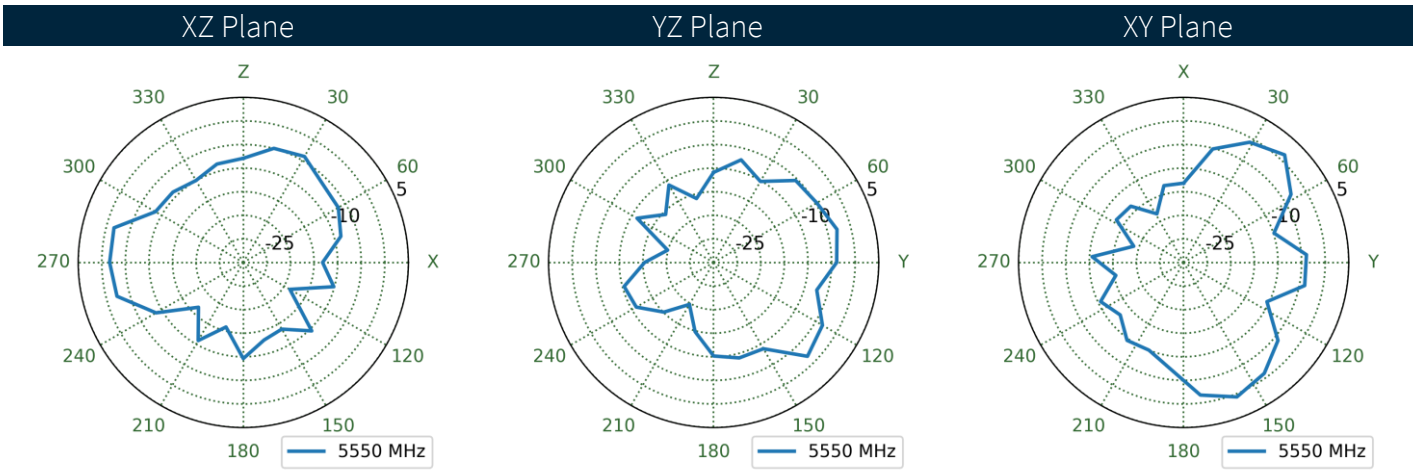
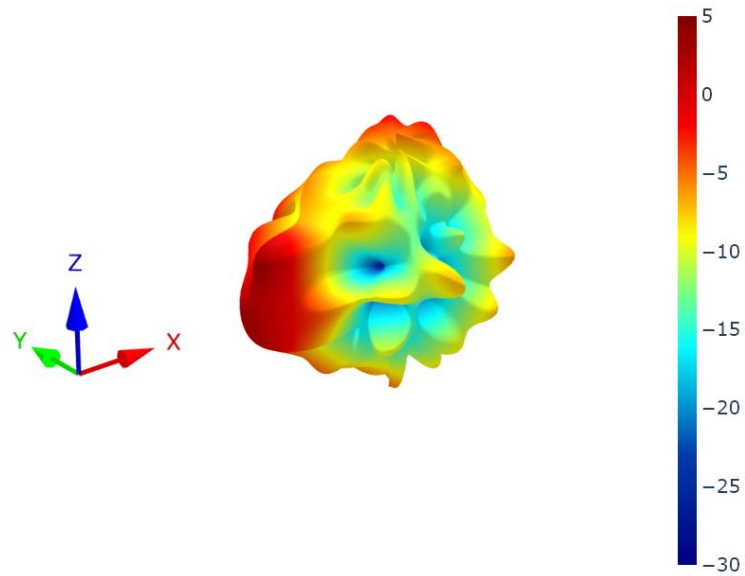

4.32 LTE1 - Free Space Patterns at 5550 MHz

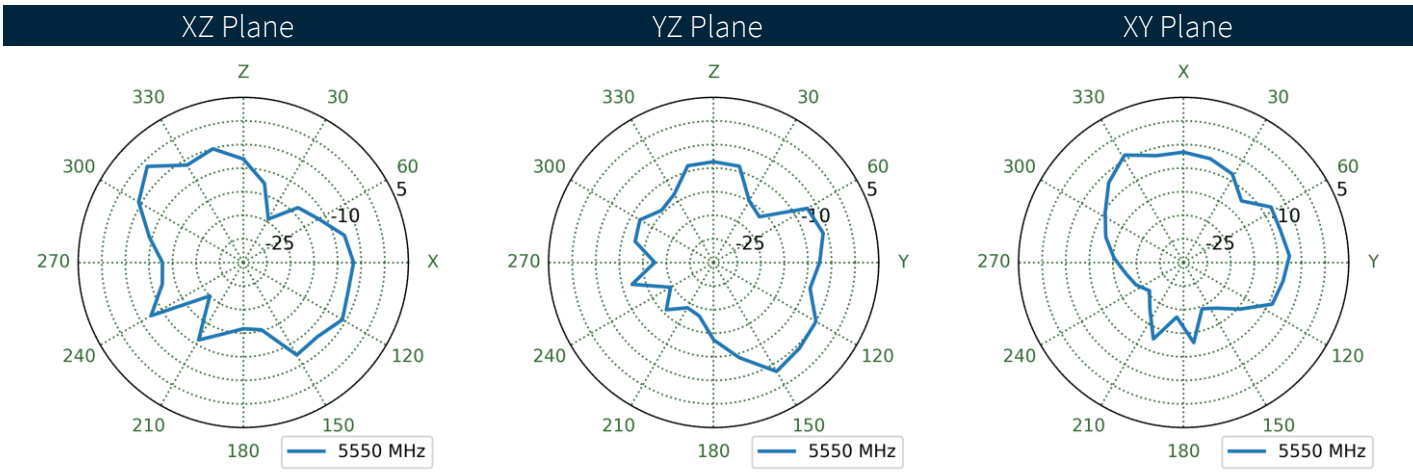
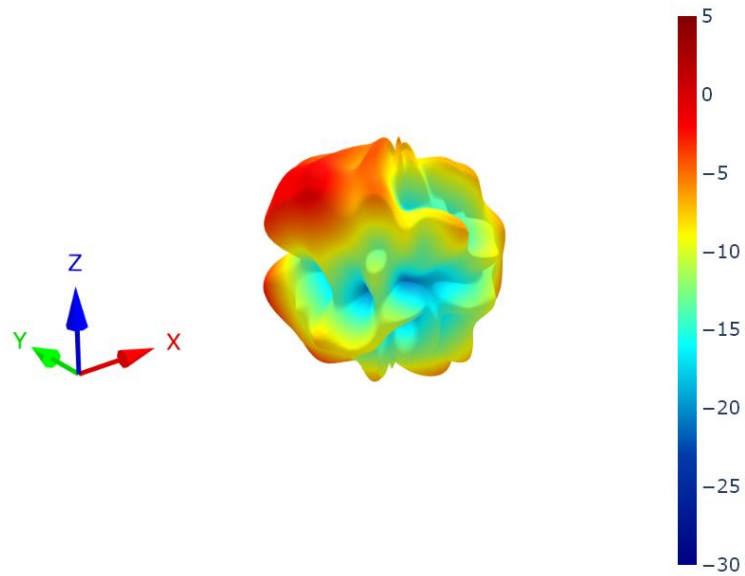

4.33 LTE2 - Free Space Patterns at 5550 MHz

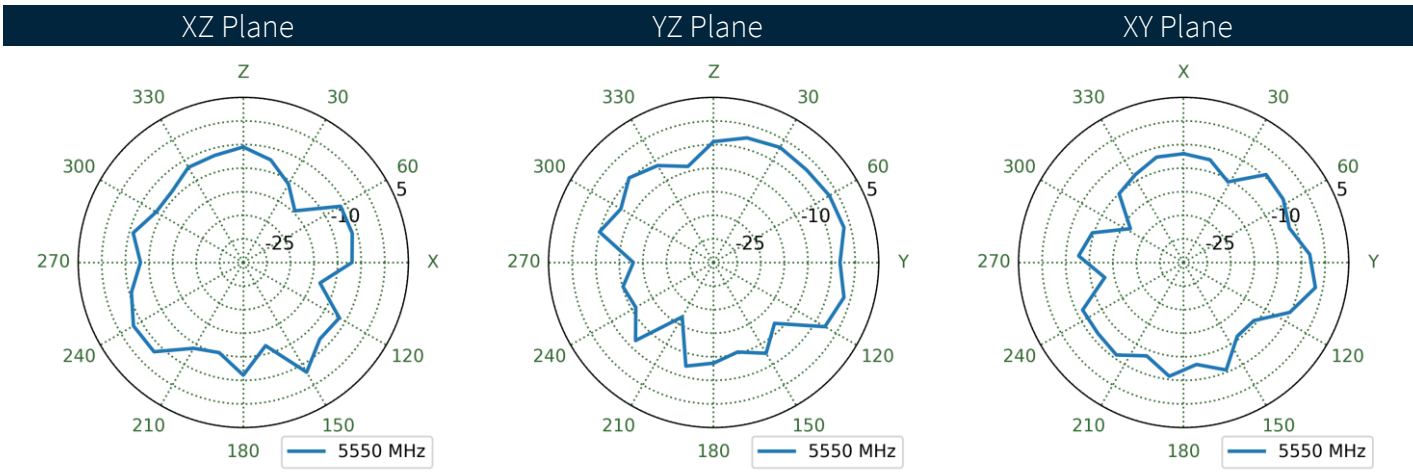
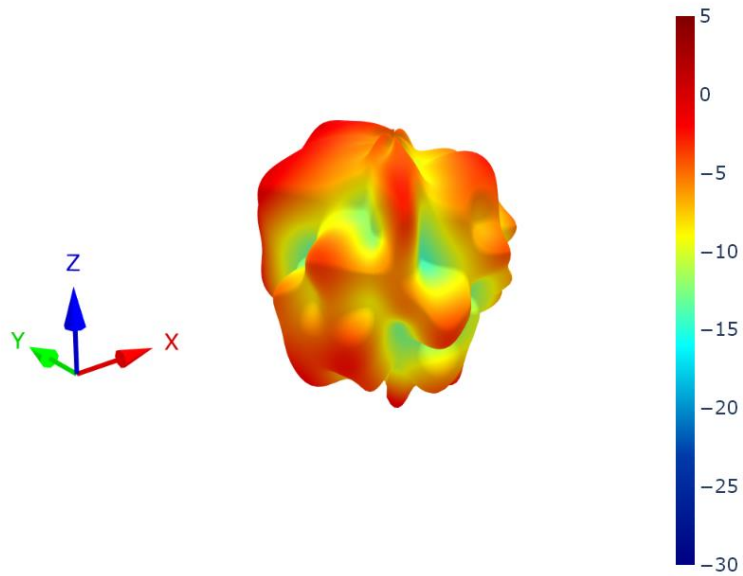

5. Mechanical Drawing

Top View

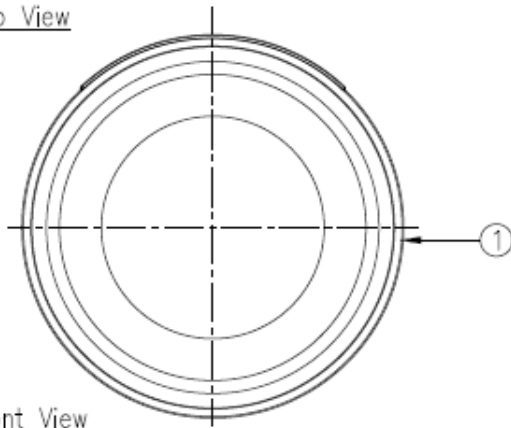

Front View

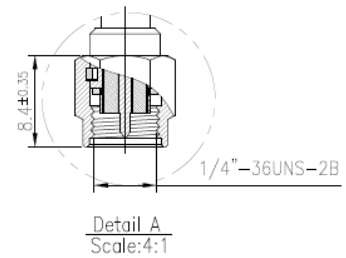
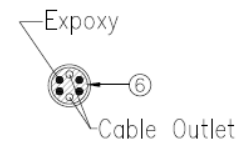
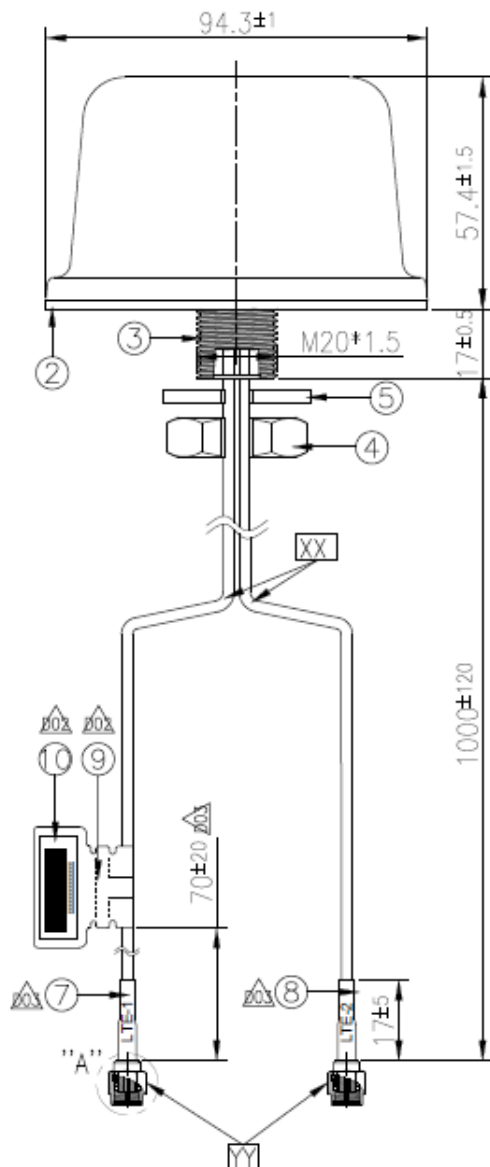

	Name	P/N	Material	Finish	QTY
1	Mini ST Short Case	000114K000092A	ASA	Black	1
2	Adhesive Foam Mini ST(Black Foam)	001015C020000A	3M9448+CR 4305	White Liner Δ	1
3	Mini ST Base	000314K000092A	Zinc Alloy	Ni Plated	1
4	Nut_M20x1.5Px10H_Cut	000413E030061A	Steel Carbon	Zn-Ni Plated Δ	1
5	Washer_Cut	000413E040061A	Steel Carbon	Zn-Ni Plated Δ	1
6	Cable Rubber	000713K000064A	Silicone	Black	1
7	Heat Shrink Tube (LTE-1)	001316C040000A	PE	Red Tube/White Text	1
8	Heat Shrink Tube (LTE-2)	001316C050000A	PE	Red Tube/White Text	1
9	Empty Label	001015G000000A	PEPA	White	1
10	Barcode Label	001015G010000A	PET	White	1
	Name	P/N	Material	Finish	QTY
XX	Cable Type	301615C000000A	RG316	Brown	2
YY	Connector Type	200212G000013A	SMA(M)ST	Au Plated	2

6. Installation Recommendation

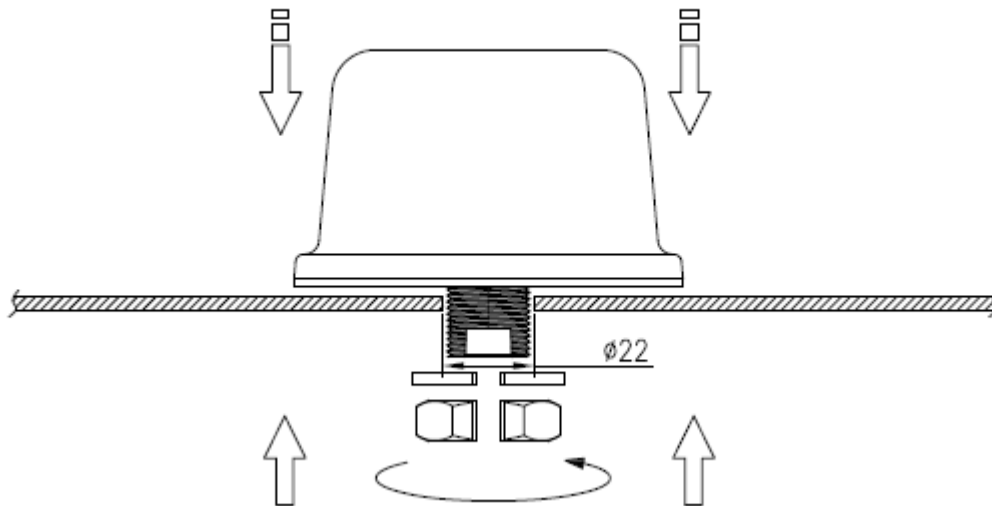

7. Packaging

1 No. MA841.A.BI.002 per small box
 Box Dimensions - 133 x 133 x 135mm
 Weight - 350g

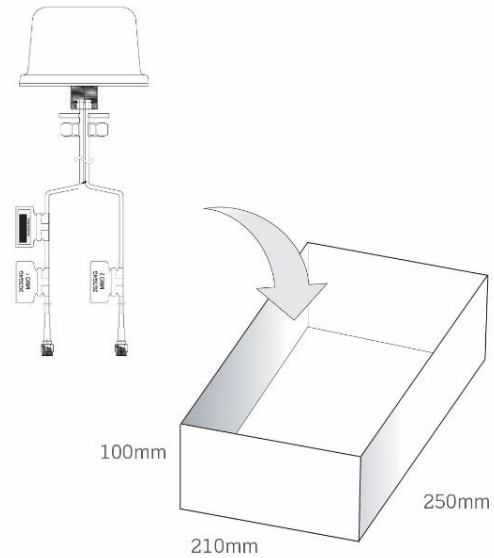

1 Outer Carton
 Carton Dimensions - 590 x 310 x 140mm
 8 pcs MA841.A.BI.002 per carton
 Weight - 3.5Kg

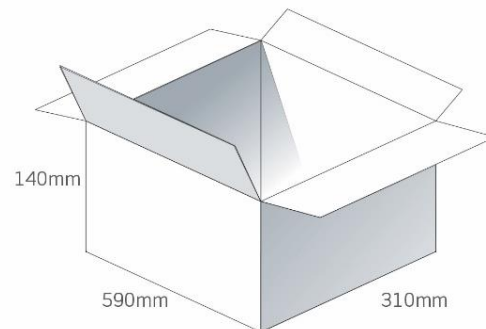

Pallet Dimensions 1200*1000*1460mm
 54 Cartons per Pallet
 9 Cartons per layer
 6 Layers

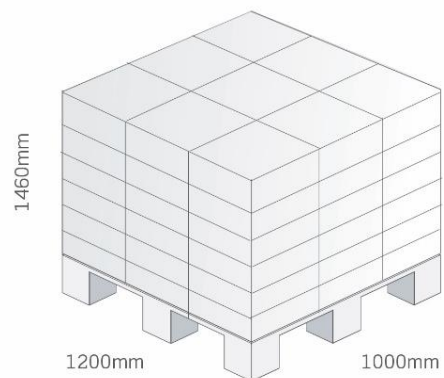

Changelog for the datasheet

SPE-19-8-152 – MA841.A.BI.002

Revision: D (Current Version)

Date:	2023-10-20
Notes:	Full update – Added ground plane test data.
Author:	Gary West

Previous Revisions

Revision: C

Date:	2023-07-25
Notes:	Updated specifications
Author:	Cesar Sousa

Revision: B

Date:	2022-02-18
Notes:	Updated data, Coverage up to 6GHz.
Author:	Gary West

Revision: A (Original First Release)

Date:	2019-12-09
Notes:	
Author:	Jack Conroy



www.taoglas.com

