



TAOGLAS®



Datasheet

Colosseum

Part No:
MA850.A.LBICG.001

Features:

- 2* 5G/4G MIMO 600~6000MHz
- 2* Wi-Fi MIMO 2.4GHz/5.8GHz
- 1* GPS-GLONASS-Galileo-BeiDou Antenna
- Permanent Mount
- Worldwide 5G/4G Bands Covered
- IP69K Enclosure
- Dimensions: Diameter 94.3mm, Height 57.4mm
- 0.3M RG174 with SMA(M)/RP-SMA(M) as standard
- Custom Cables and Connectors Available
- CE Certified
- RoHS & REACH Compliant

1. Introduction	3
2. Specifications	4
3. Antenna Characteristics	9
4. Radiation Patterns	20
5. Mechanical Drawing	58
6. Installation Guide	59
7. Packaging	60
8. Application Note	61
<hr/>	
Changelog	70

Taoglas makes no warranties based on the accuracy or completeness of the contents of this document and reserves the right to make changes to specifications and product descriptions at any time without notice. Taoglas reserves all rights to this document and the information contained herein. Reproduction, use or disclosure to third parties without express permission is strictly prohibited.



1. Introduction



The Colosseum MA850 5in1 antenna is a low profile, heavy-duty, fully IP69K waterproof external antenna for use in worldwide telematics applications which require best in class 5G/4G, Wi-Fi and GNSS performance. It is ideal for solutions that do not have space for mounting the larger Pantheon dome antennas but still require good efficiency and gain.

This unique product, at only 57.4mm tall, delivers powerful worldwide 5G/4G MIMO antenna technology from 600-6000MHz and also dual-band Wi-Fi MIMO, plus GPS-GLONASS-Galileo-BeiDou for location tracking applications. The 5G/4G antennas also include legacy 3G and 2G bands to enable fallback using the correct modems in areas where there is no 5G/4G signal.

Typical Applications include:

- Bus Telematics
- Remote Asset and Pipeline Monitoring
- HD Video over LTE
- First Responder and Emergency Services
- Automotive Vehicle Tracking and Telematics

5G/4G applications demand high speed data uplink and downlink. High efficiency and high gain MIMO antennas are necessary to achieve the required signal to noise ratio and throughput required to solve these challenges. Taoglas also takes care to have high isolation between the two MIMO antennas to prevent self-interference. Low loss cables are used to keep efficiency high over long cable lengths. In contrast, smaller MIMO antennas with poorer quality thinner cables will have much reduced efficiency and isolation, which would lead to a large drop in system throughput or drops, and may indeed not make a system connection at all.

The GPS-GLONASS-Galileo-BeiDou active antenna has been carefully designed to work well on GPS, GLONASS, Galileo and BeiDou L1 bands, leading to higher location accuracy and stability of tracking in urban environments.

Cable length and connector types are customizable. Contact your regional Taoglas customer support team for further information.

2. Specifications

GNSS Frequency Bands					
GPS	L1 1575.42 MHz	L2 1227.6 MHz	L5 1176.45 MHz		
	■	□	□		
GLONASS	G1 1602 MHz	G2 1248 MHz	G3 1207 MHz		
	■	□	□		
Galileo	E1 1575.24 MHz	E5a 1176.45 MHz	E5b 1201.5 MHz	E6 1278.75 MHz	
	■	□	□	□	
BeiDou	B1C 1575.42 MHz	B1I 1561 MHz	B2a 1176.45 MHz	B2b 1207.14 MHz	B3 1268.52 MHz
	■	■	□	□	□
L-Band	L-Band 1542 MHz				
	□				
QZSS (Regional)	L1 1575.42 MHz	L2C 1227.6 MHz	L5 1176.45 MHz	L6 1278.75e6	
	■	□	□	□	
IRNSS (Regional)	L5 1176.45 MHz				
	□				
SBAS	L1/E1/B1 1575.42 MHz	L5/B2a/E5a 1176.45 MHz	G1 1602 MHz	G2 1248 MHz	G3 1207 MHz
	■	□	■	□	□

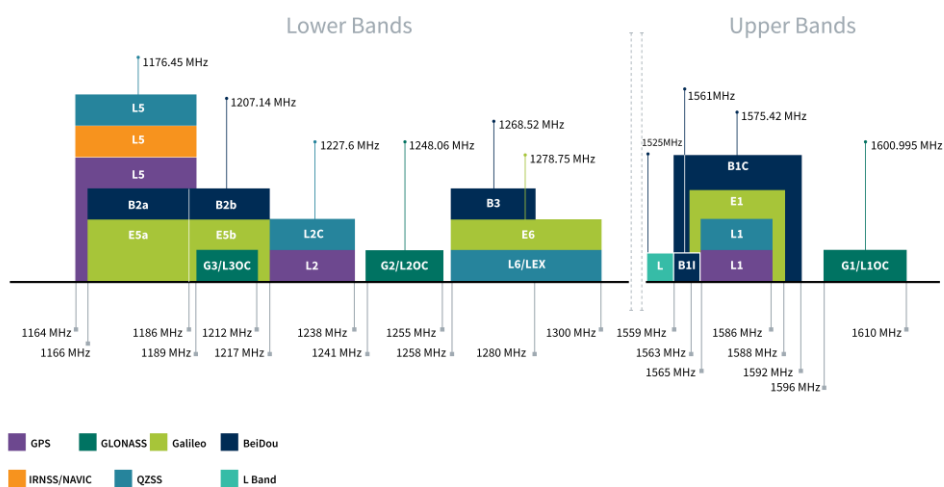

GNSS Bands and Constellations

GNSS Electrical			
Frequency (MHz)	1575.42MHz	1602MHz	1561MHz
Passive Antenna Efficiency (%) (Without cable loss)	44%	58%	49%
Passive Antenna Average Gain (dB) (Without cable loss)	-3.5dB	-2.4dB	-3.1dB
Passive Antenna Peak Gain (dBi) (Without cable loss)	2.3dBi	4.3dBi	3.3dBi
Axial Ratio (dB)	<6.2	<9.8	<16.5
VSWR (max.)	3:1 Max		
Polarization	RHCP		
Impedance	50Ω		

LNA and Filter Electrical Properties				
Frequency (MHz)	1575.42MHz	1602MHz	1561MHz	
Pout 1dB Gain Compression Point	-6dBm Min. -2 dBm Typ. (1561MHz,1575.42MHz,1602MHz)			
Output Impedance	50Ω			
VSWR	< 2:1			
Return Loss	10 dB Min.			
LNA Gain, Current Draw, and Noise Figure @GPS	Voltage	LNA Gain(Typ.)	Current Draw(Typ.)	Noise Figure(Typ.)
	Min 1.8V	28dB	7.9mA	1.9dB
	Typ. 3.0V	28dB	8.3mA	2.7dB
	Max 5.5V	30dB	8.3mA	2.2dB

Total Specification (Through Antenna, SAW Filter and LNA)			
Frequency (MHz)	1561.068±2.046MHz	1575.42±1.023MHz	1602±5MHz
Gain@3V (dBi)	1575.42MHz:31±3dBi	1575.42MHz:31±3dBi	1602MHz:31±3dBi
Output Impedance	50 Ω		

5G/4G Electrical								
Band	Frequency (MHz)		Efficiency (%)	Average Gain (dB)	Peak Gain (dBi)	Impedance	VSWR	Polarization
5G NR/4G Band 71	617~698	LTE 1	27	-5.8	0.59	50Ω	< 3	Linear
		LTE 2	20	-7.1	1.48			
4G/3G Band 12,13,14,17,28,29	698~806	LTE 1	37	-4.3	2.70			
		LTE 2	20	-7.1	2.57			
4G/3G/NB-IoT/Cat M Band 5,8,18,19,20,26,27	824~960	LTE 1	36	-4.4	2.13			
		LTE 2	31	-5.3	2.00			
5G NR/4G Band 21,32,74,75,76	1427~1518	LTE 1	30	-5.4	1.66			
		LTE 2	26	-5.9	2.02			
4G/3G Band 1,2,3,4,9,23,25,35,39,66	1710~2200	LTE 1	47	-3.6	4.88			
		LTE 2	39	-4.1	4.88			
4G/3G Band 7,30,38,40,41	2300~2690	LTE 1	46	-3.4	6.77			
		LTE 2	46	-3.3	6.74			
5G NR/4G Band 22,42,48,77,78,79	3300~4200	LTE 1	44	-3.6	5.33			
		LTE 2	40	-4.1	5.39			
LTE5200/ Wi-Fi 5800	5150~5925	LTE 1	36	-4.4	3.95			
		LTE 2	27	-5.7	3.71			

WiFi Electrical									
Band	Frequency (MHz)		Efficiency (%)	Average Gain (dB)	Peak Gain (dBi)	ECC	VSWR	Impedance	Polarization
2.4GHz	2400~2500	Wi-Fi 1	50	-3.0	3.9	<0.3	<2	50Ω	Linear
		Wi-Fi 2	54	-2.7	3.9				
5.8GHz	4900~5850	Wi-Fi 1	49	-3.2	5.3	<0.3	<3.5		
		Wi-Fi 2	45	-3.5	5.7				

Mechanical	
Dimensions	Diameter: 94.3mm, Height: 57.4 mm
Casing	ASA
Base and thread	Zinc Alloy
Weight	250g
Ingress Protection Rating	IP69K
Recommended Troque for Mounting	5-7 N•m
Cables	GNSS – 0.3 meter RG174 standard, fully customizable Wi-Fi – 0.3M RG174 standard, fully customizable Cellular - 0.3M RG174 standard, fully customizable
Connectors	GNSS – SMA(M), standard, fully customizable Wi-Fi – RP-SMA(M) standard, fully customizable Cellular - SMA(M) standard, fully customizable
Environmental	
Operation Temperature	-40°C to 85°C
Storage Temperature	-40°C to 85°C
Humidity	Non-condensing 65°C 95% RH

5G/4G Bands			
Band Number	5GNR / FR1 / LTE / LTE-Advanced / WCDMA / HSPA / HSPA+ / TD-SCDMA		
	Uplink	Downlink	Covered
1	UL: 1920 to 1980	DL: 2110 to 2170	✓
2	UL: 1850 to 1910	DL: 1930 to 1990	✓
3	UL: 1710 to 1785	DL: 1805 to 1880	✓
4	UL: 1710 to 1755	DL: 2110 to 2155	✓
5	UL: 824 to 849	DL: 869 to 894	✓
7	UL: 2500 to 2570	DL: 2620 to 2690	✓
8	UL: 880 to 915	DL: 925 to 960	✓
9	UL: 1749.9 to 1784.9	DL: 1844.9 to 1879.9	✓
11	UL: 1427.9 to 1447.9	DL: 1475.9 to 1495.9	✓
12	UL: 699 to 716	DL: 729 to 746	✓
13	UL: 777 to 787	DL: 746 to 756	✓
14	UL: 788 to 798	DL: 758 to 768	✓
17	UL: 704 to 716	DL: 734 to 746	✓
18	UL: 815 to 830	DL: 860 to 875	✓
19	UL: 830 to 845	DL: 875 to 890	✓
20	UL: 832 to 862	DL: 791 to 821	✓
21	UL: 1447.9 to 1462.9	DL: 1495.9 to 1510.9	✓
22	UL: 3410 to 3490	DL: 3510 to 3590	✓
23	UL: 2000 to 2020	DL: 2180 to 2200	✓
24	UL: 1625.5 to 1660.5	DL: 1525 to 1559	✓
25	UL: 1850 to 1915	DL: 1930 to 1995	✓
26	UL: 814 to 849	DL: 859 to 894	✓
27	UL: 807 to 824	DL: 852 to 869	✓
28	UL: 703 to 748	DL: 758 to 803	✓
29	UL: -	DL: 717 to 728	✓
30	UL: 2305 to 2315	DL: 2350 to 2360	✓
31	UL: 452.5 to 457.5	DL: 462.5 to 467.5	✗
32	UL: -	DL: 1452 - 1496	✓
35		1850 to 1910	✓
38		2570 to 2620	✓
39		1880 to 1920	✓
40		2300 to 2400	✓
41		2496 to 2690	✓
42		3400 to 3600	✓
43		3600 to 3800	✓
48		3550 to 3700	✓
66	UL: 1710-1780	DL: 2110-2200	✓
71		617 to 698	✓
74/75/76		1427 to 1518	✓
78		3300 to 3800	✓
79		4400 to 5000	✓
85	698-716	728-746	✓

3. Antenna Characteristics

3.1 GNSS – Block Diagram

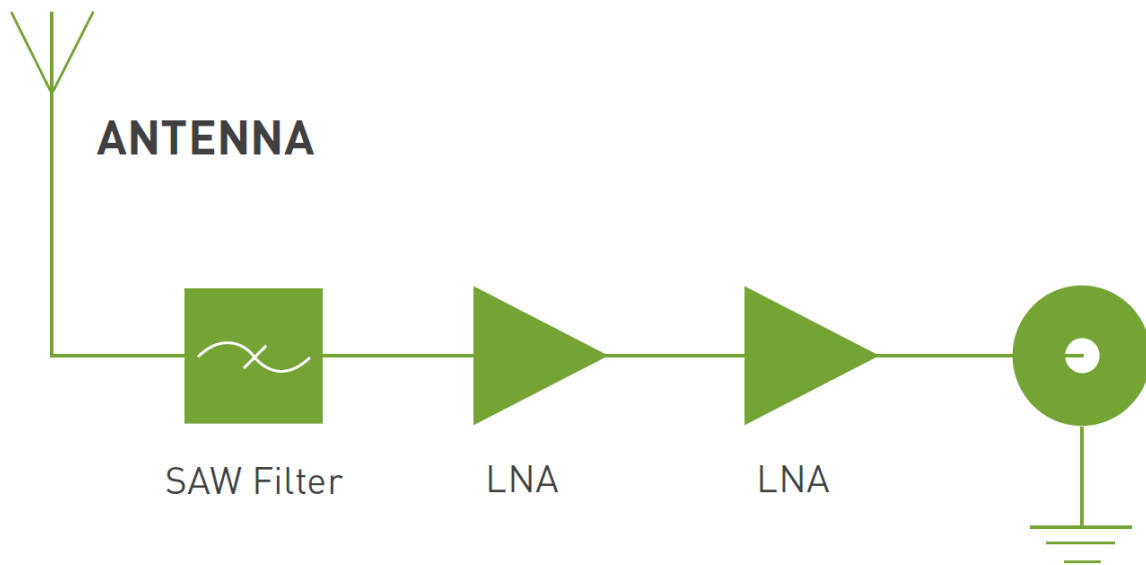

3.2 GNSS – Return Loss

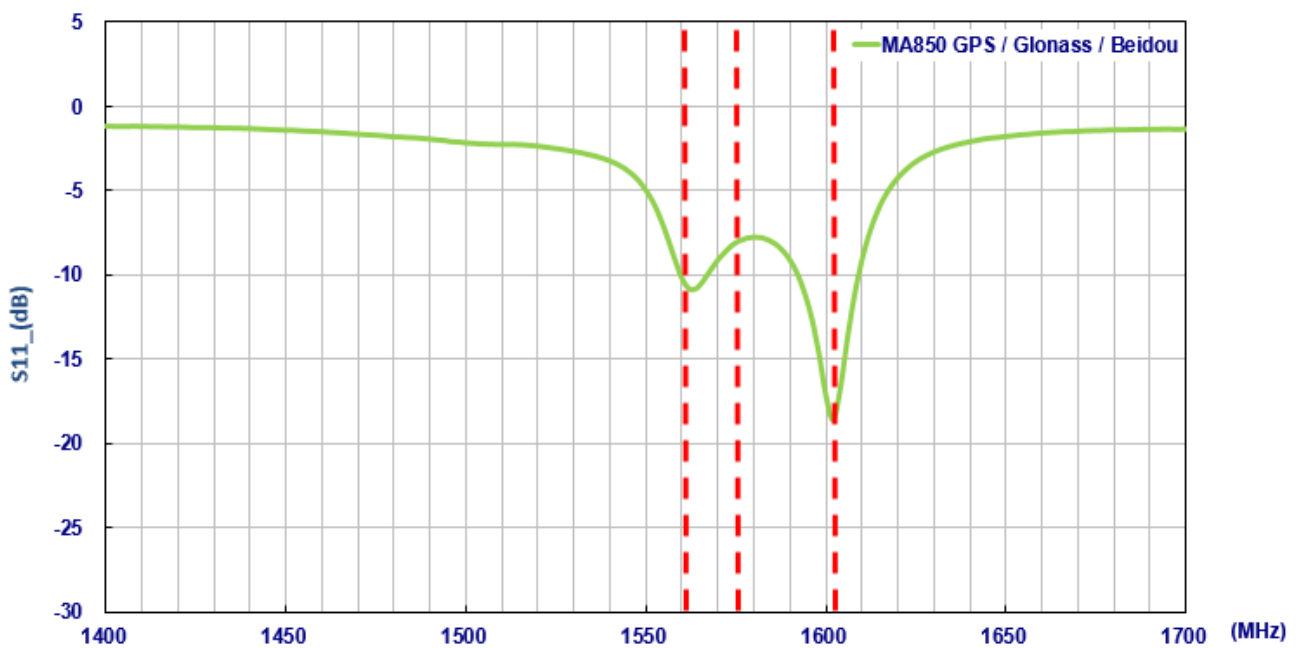

3.3 GNSS - VSWR

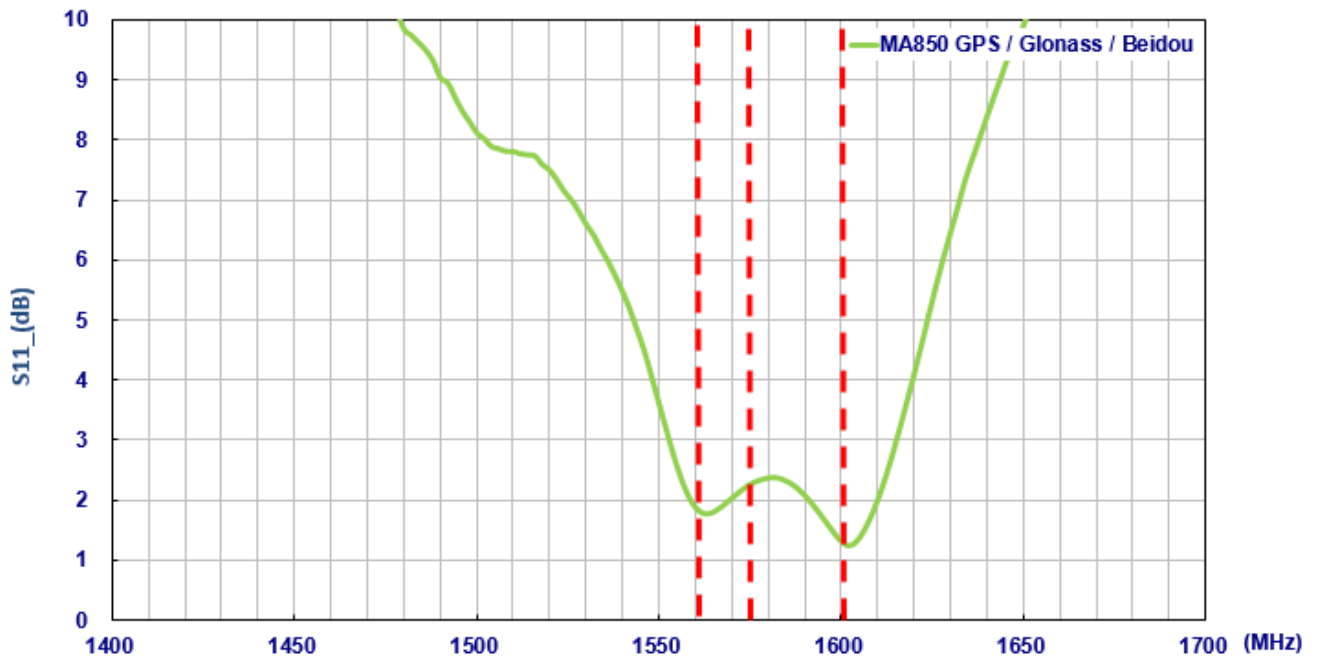

3.4 GNSS – Smith Chart

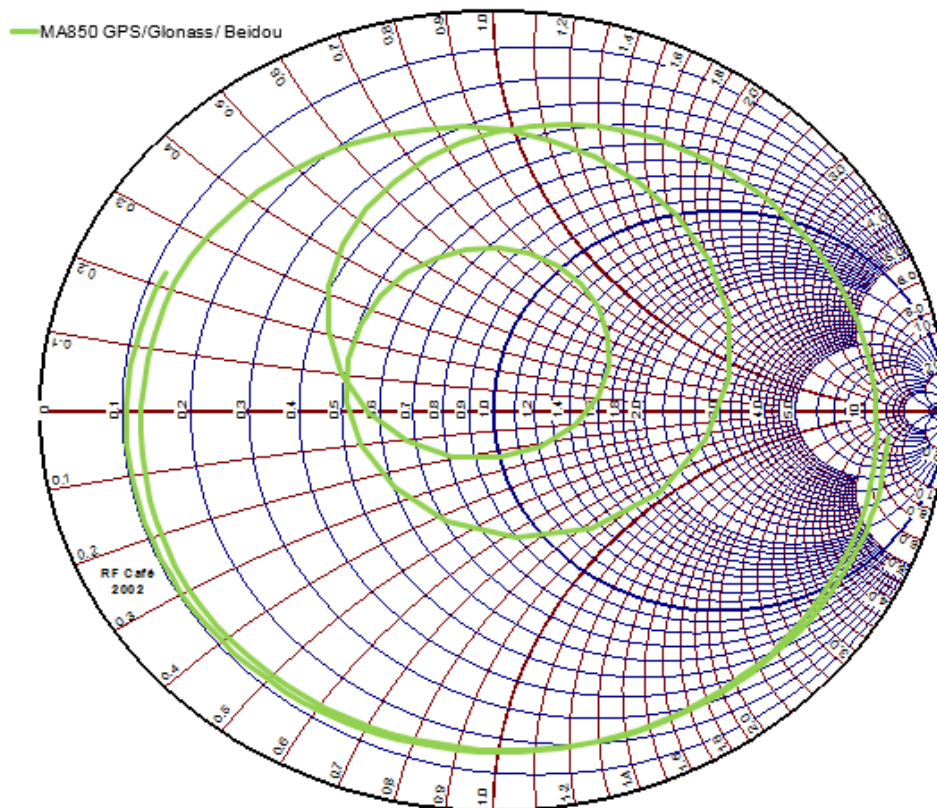

3.5 GNSS – Efficiency

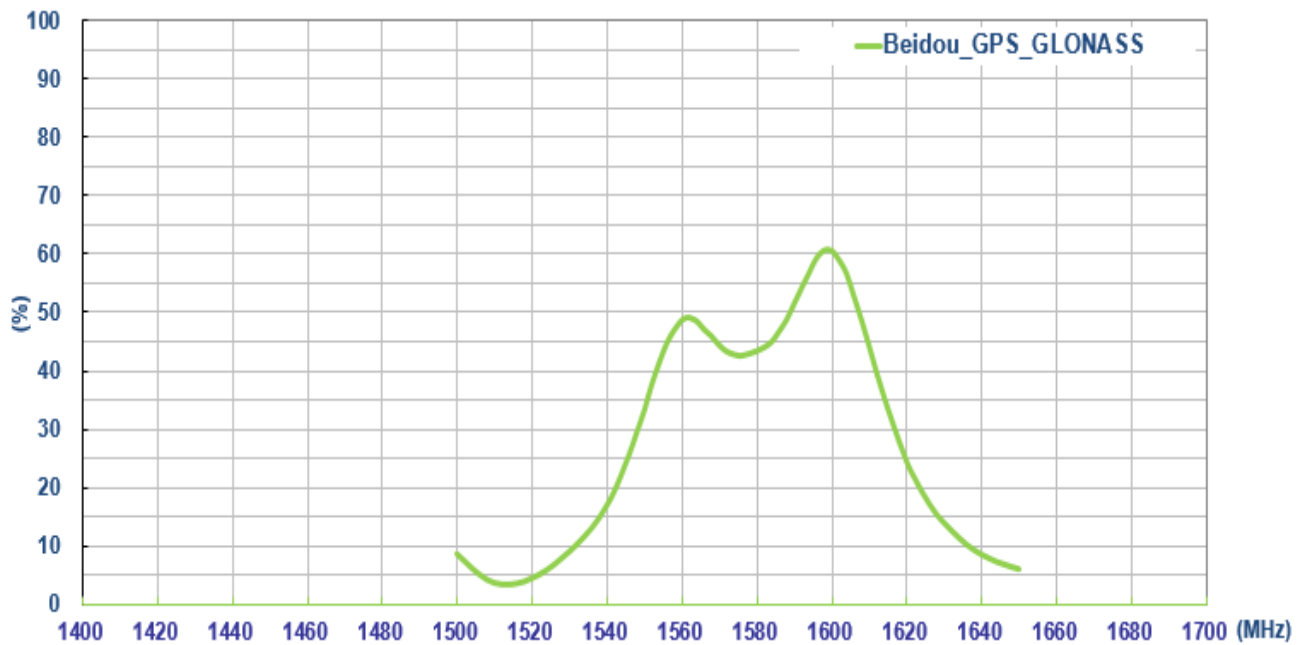

3.6 GNSS - Peak Gain

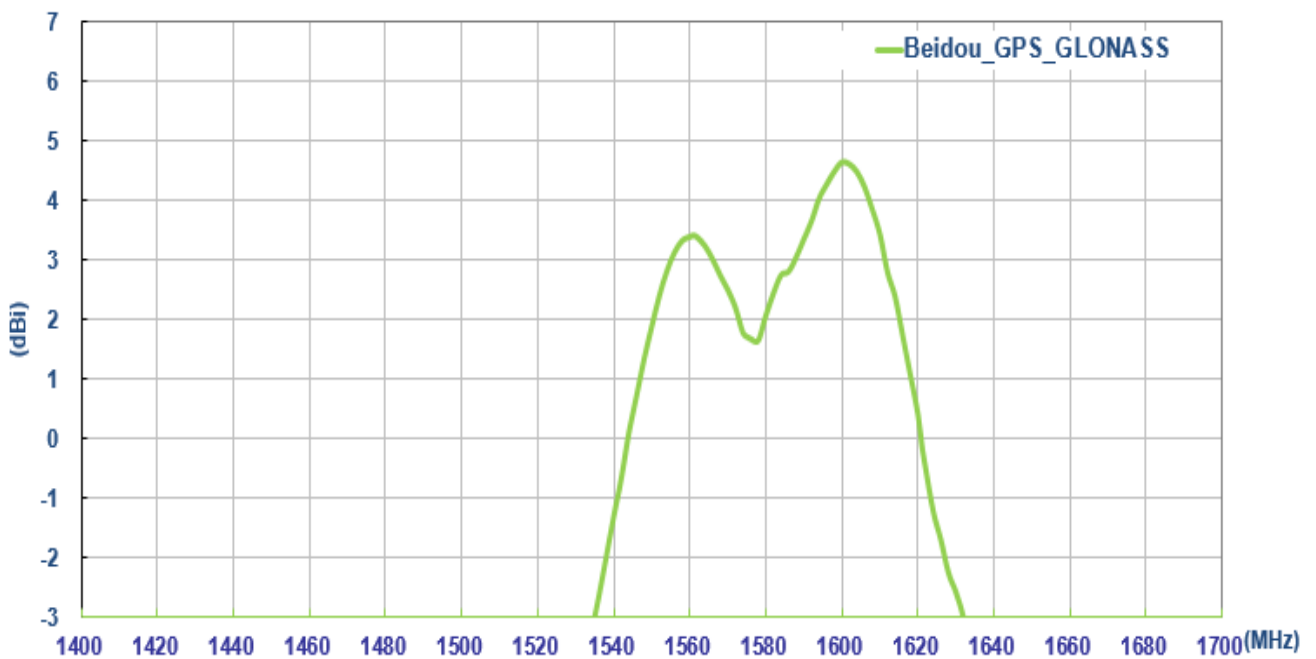

3.7 GNSS – Average Gain

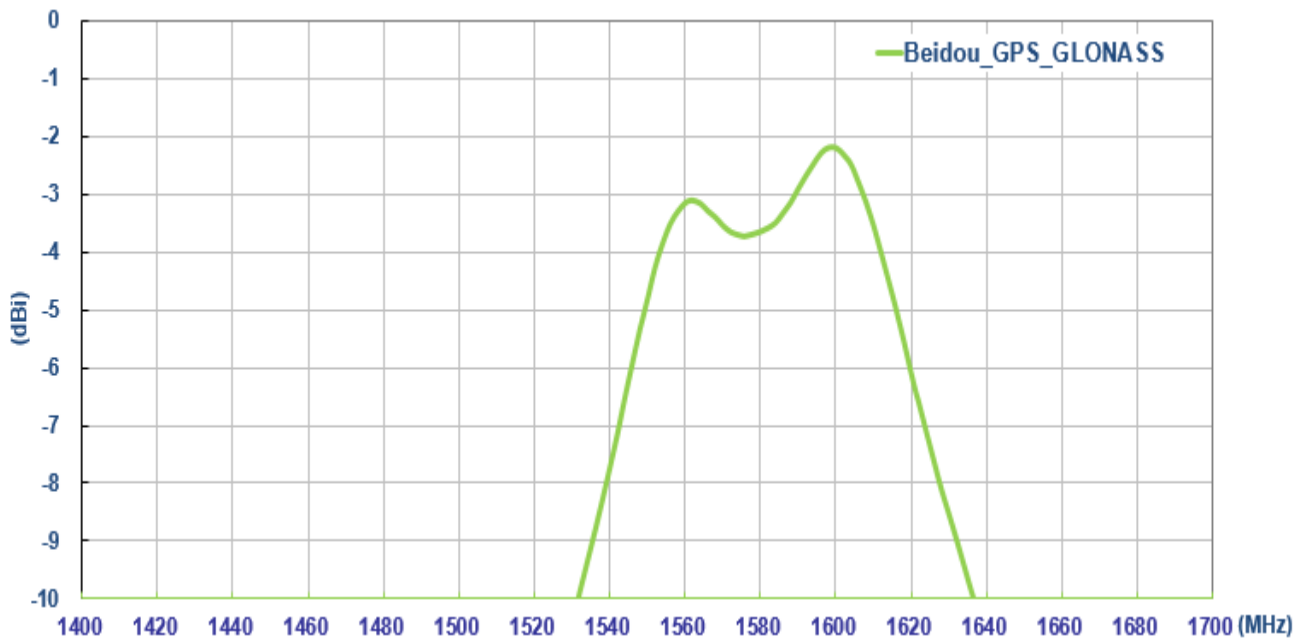

3.8 GNSS – Axial Pattern (1561MHz)

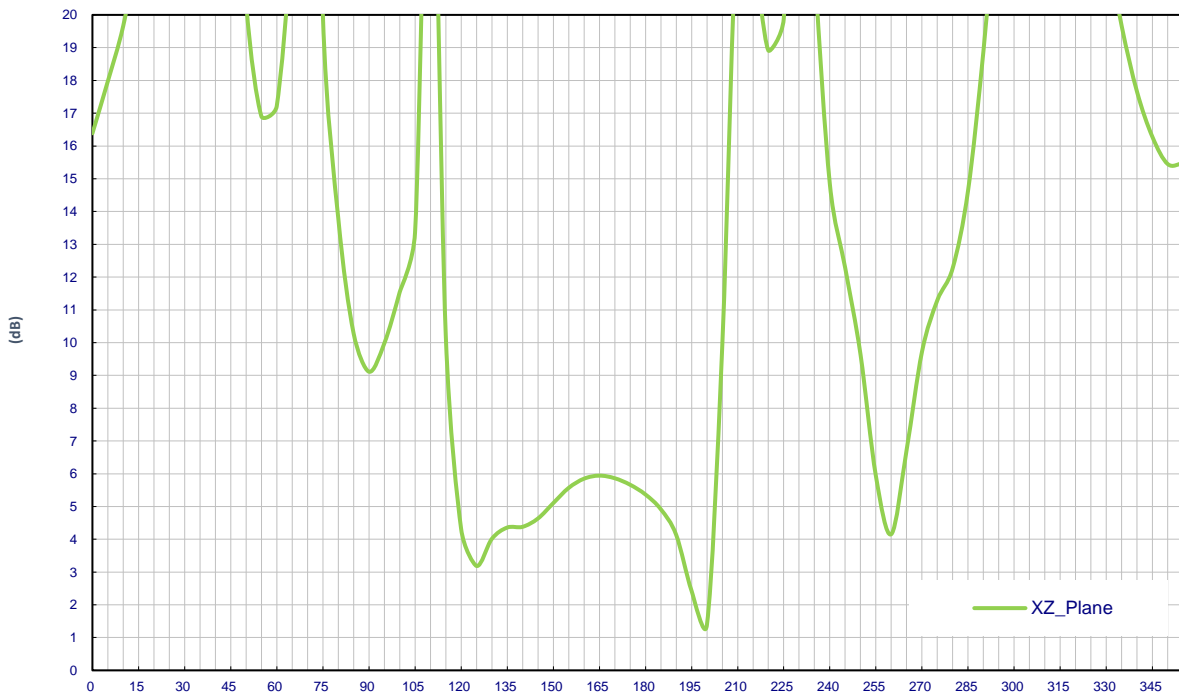

3.9 GNSS – Axial Pattern (1575.42MHz)

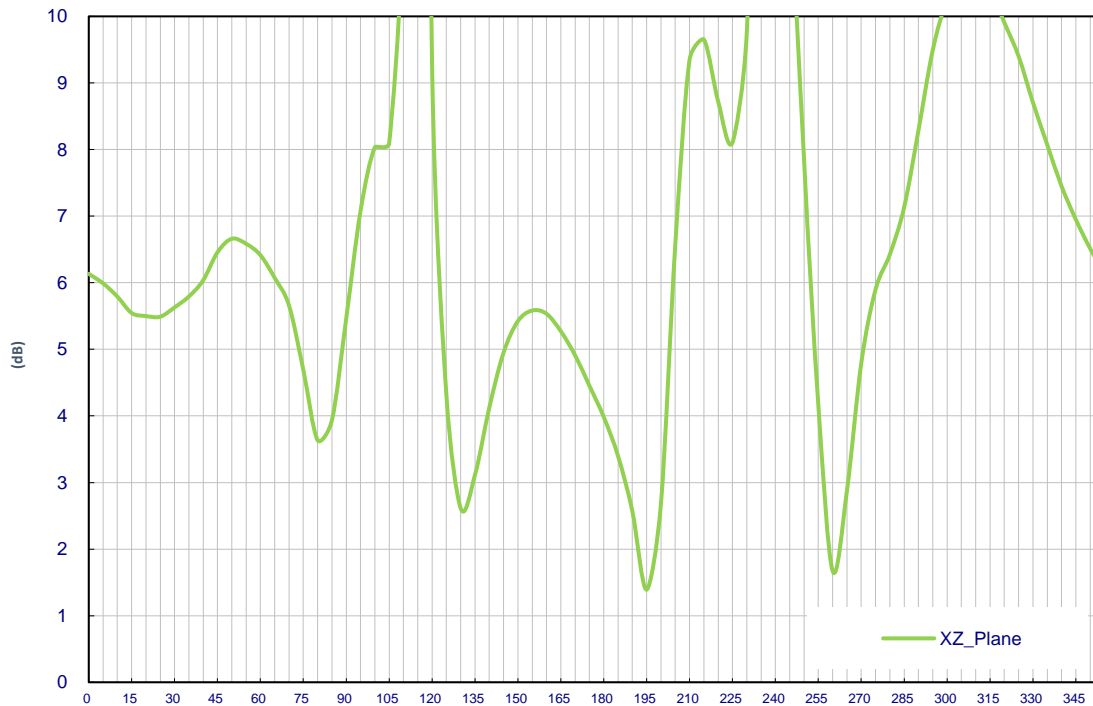

3.10 GNSS – Axial Pattern (1602MHz)

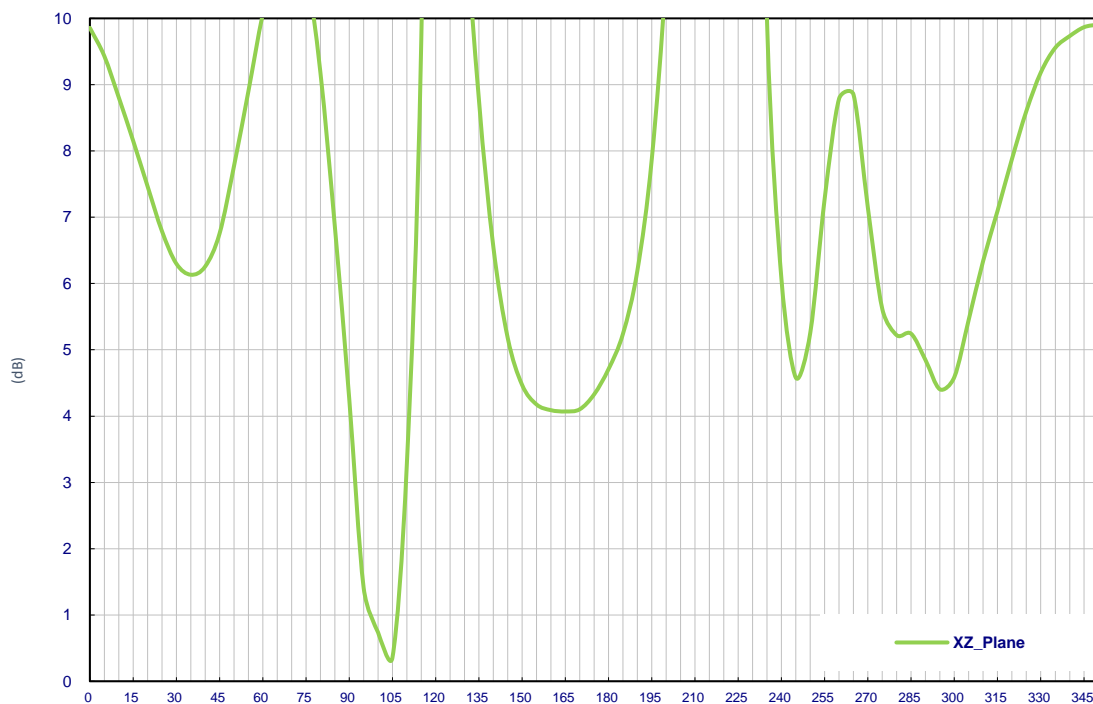

3.11 GNSS – LNA Gain @3.0V (Active Antenna)

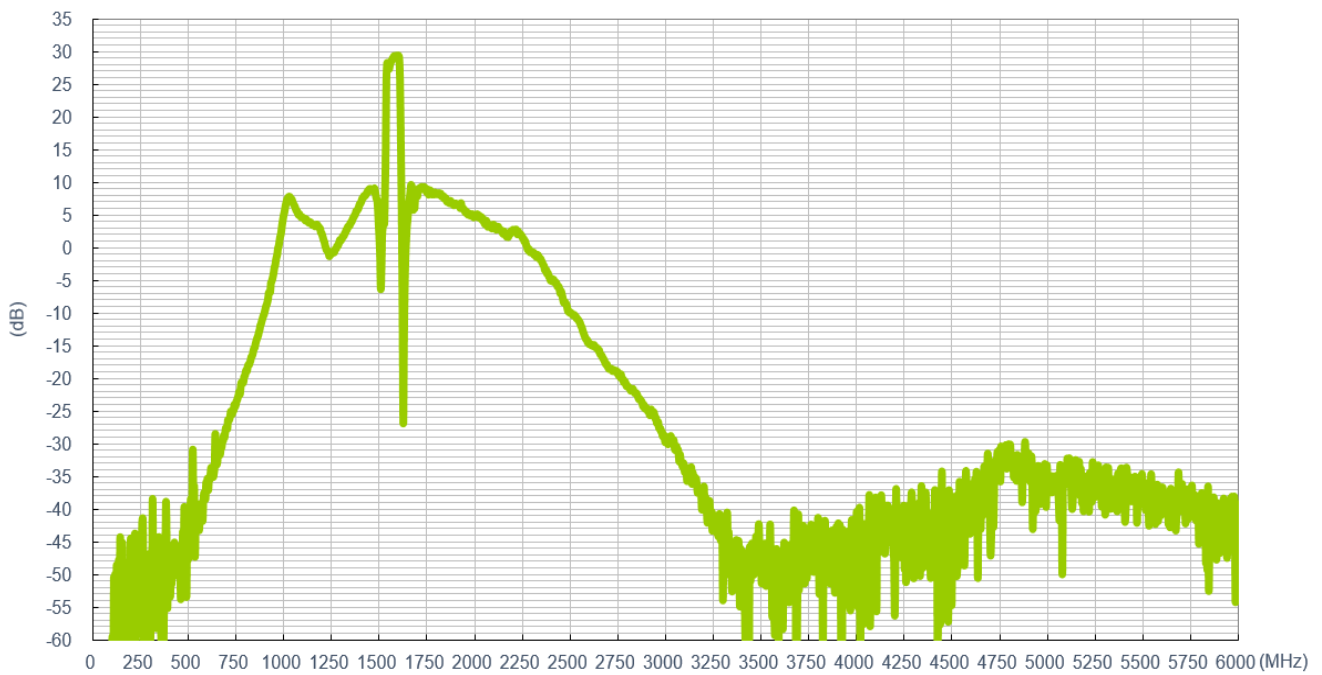

3.12 GNSS – LNA Noise Figure @3.0V (Active Antenna)

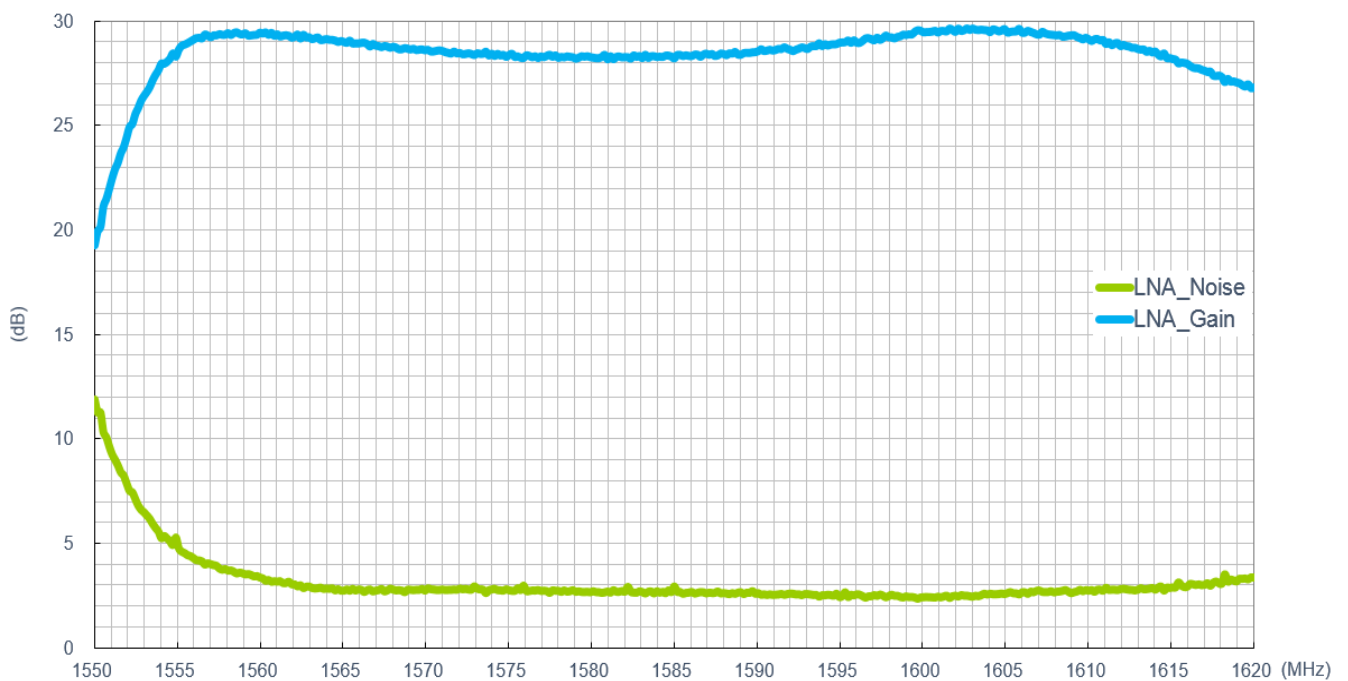

3.13 LTE – Return Loss

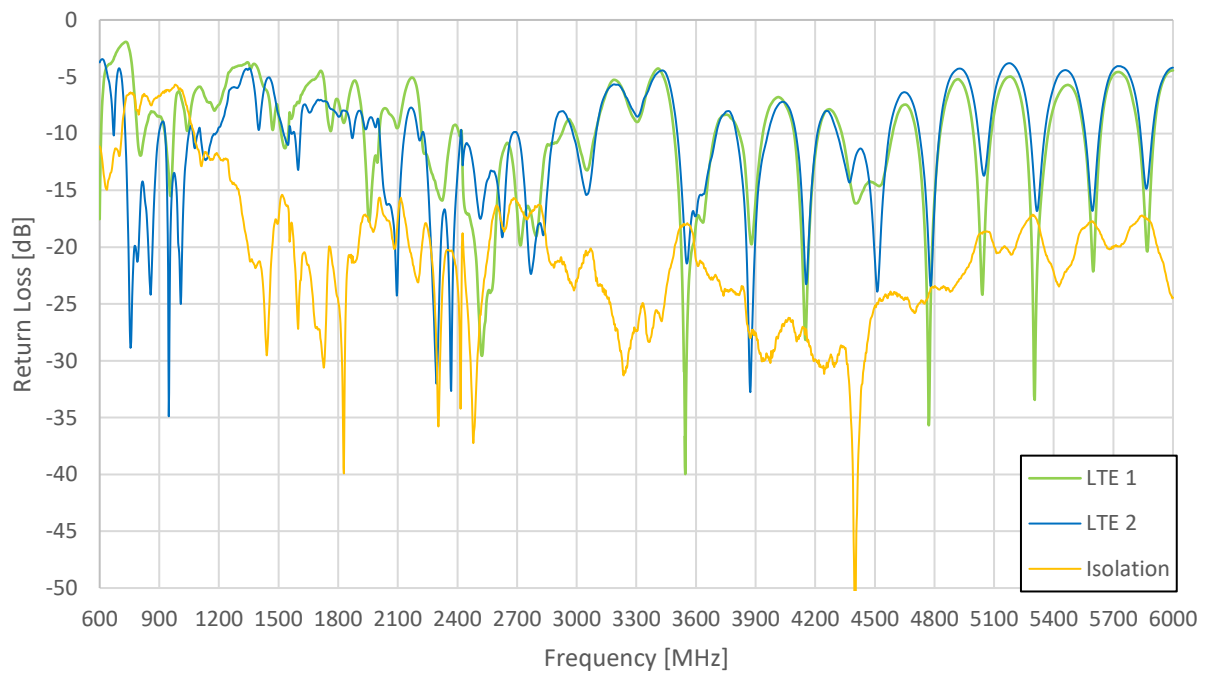

3.14 LTE - Efficiency

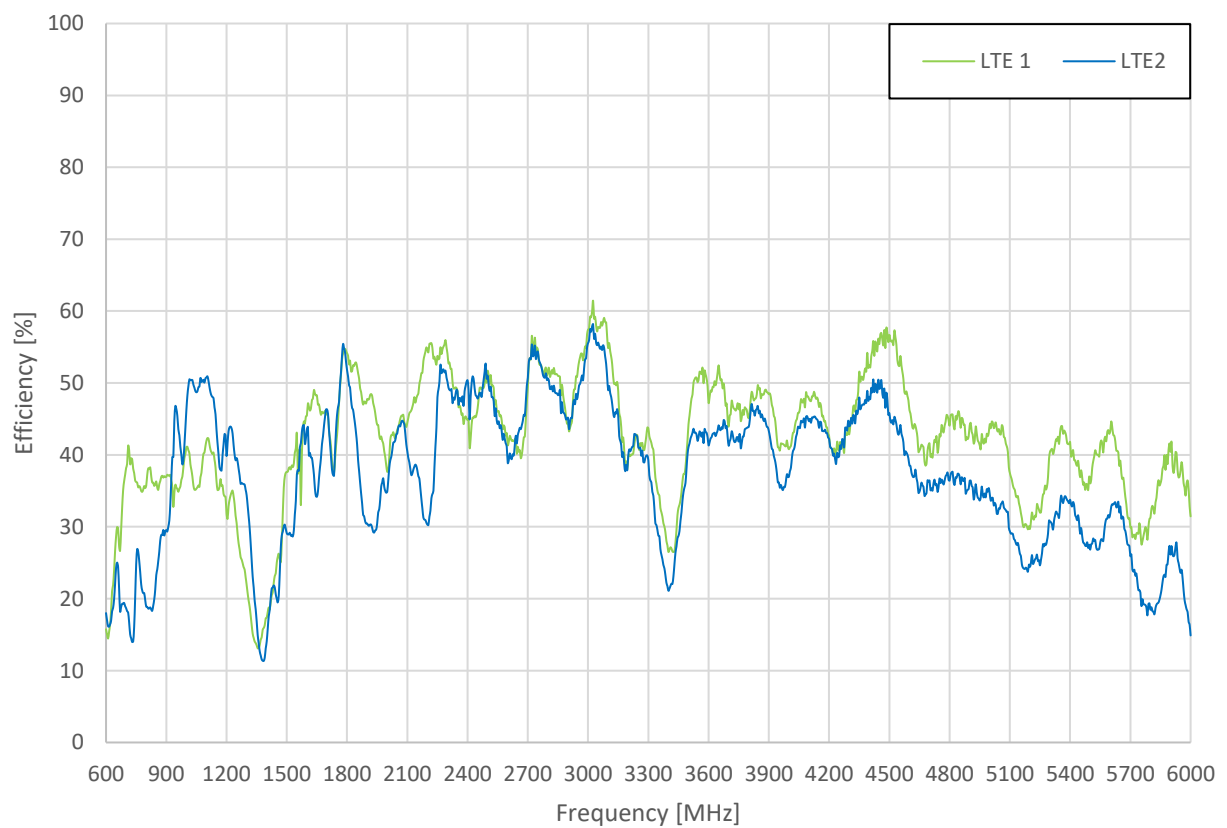

3.15 LTE – Average Gain

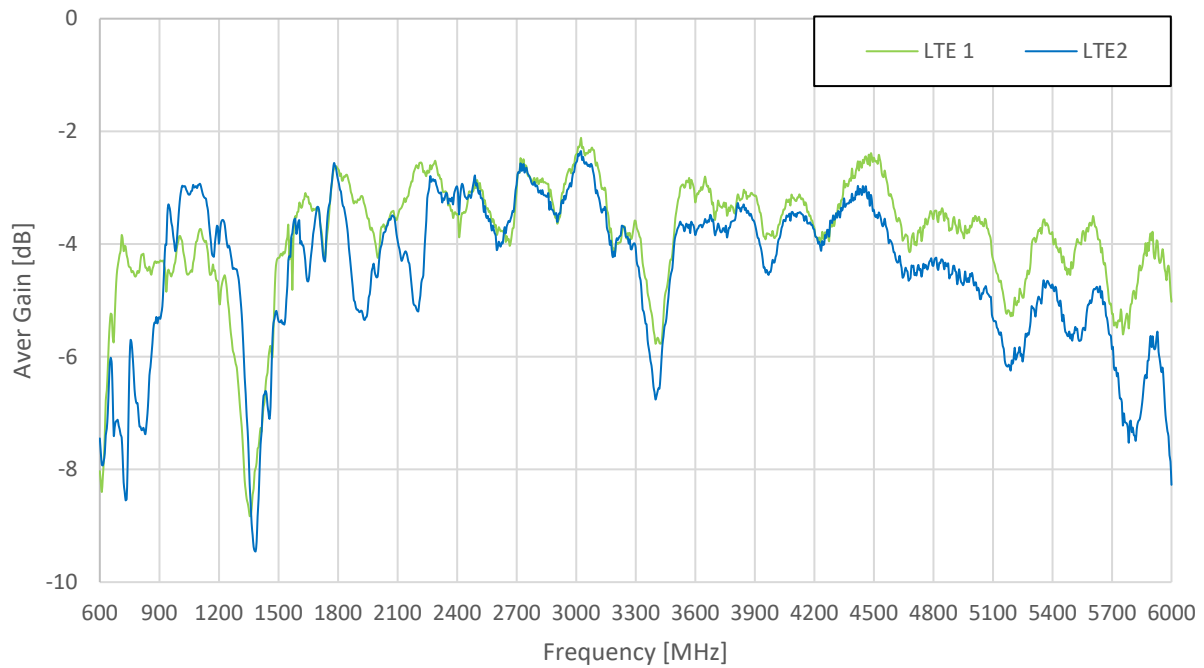

3.16 LTE – Peak Gain

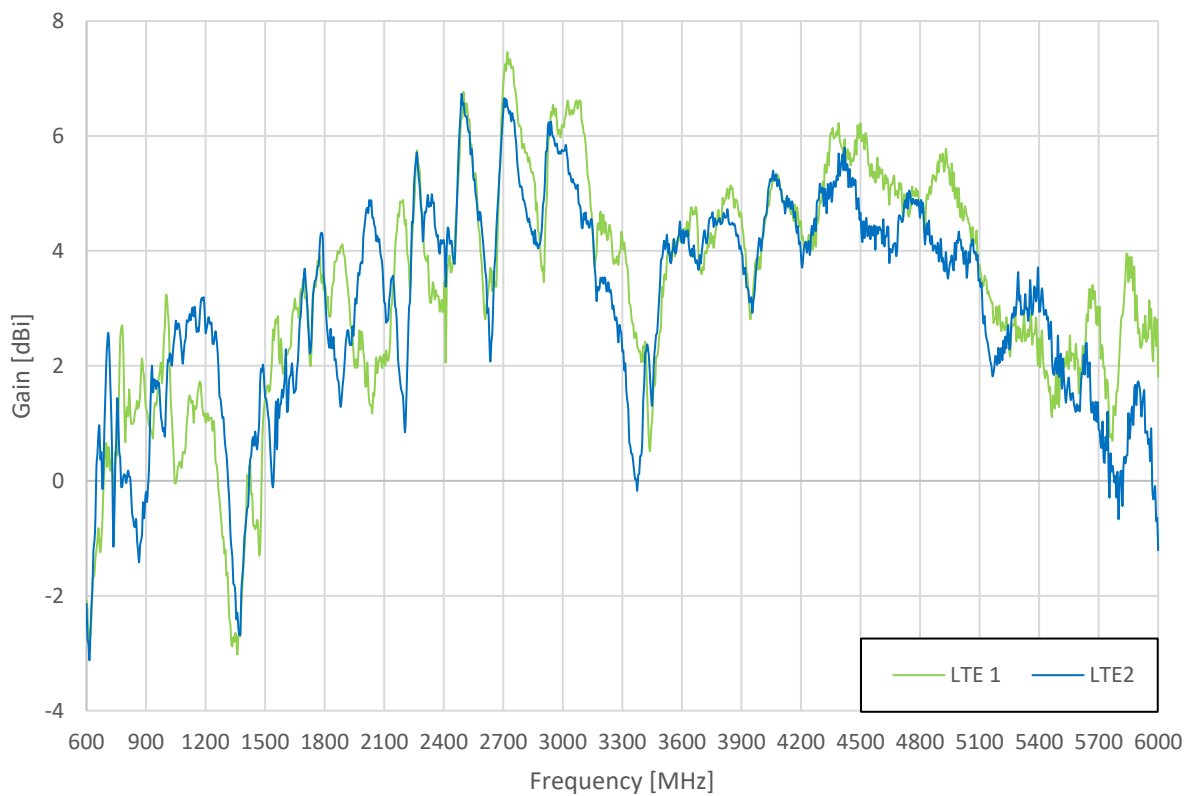

3.17 LTE – ECC

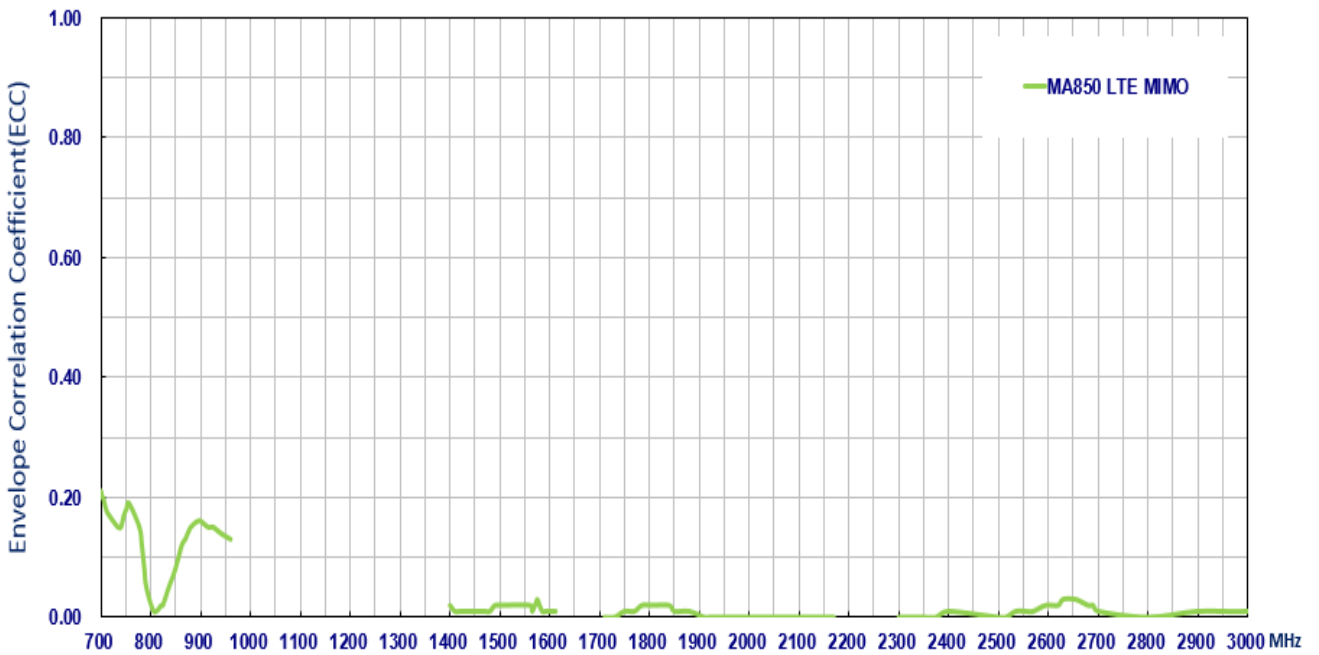

3.18 Wi-Fi – Return Loss & Isolation

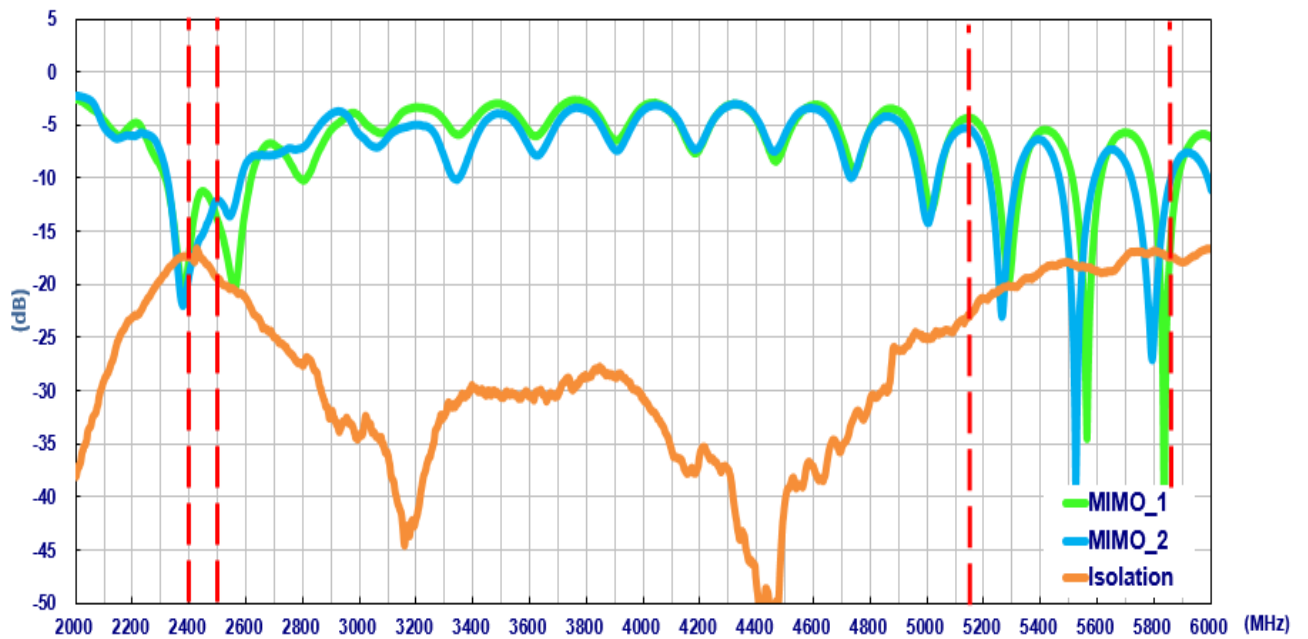

3.19 Wi-Fi - Efficiency

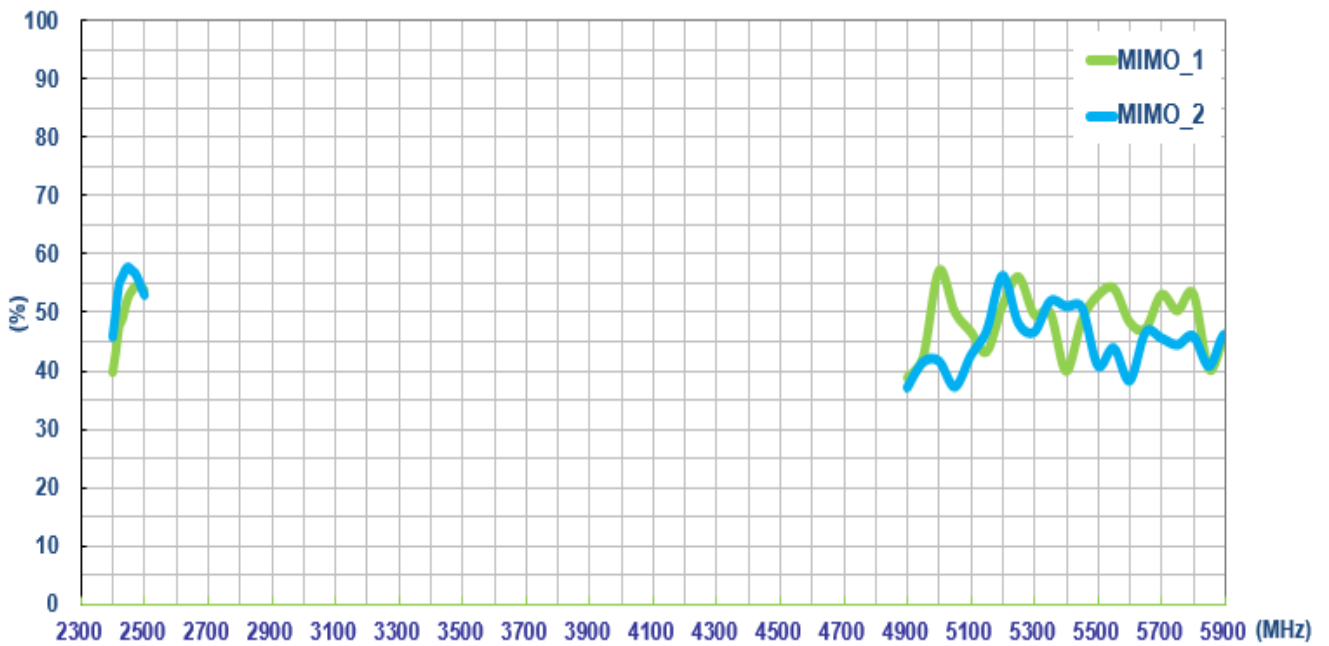

3.20 Wi-Fi - Average Gain

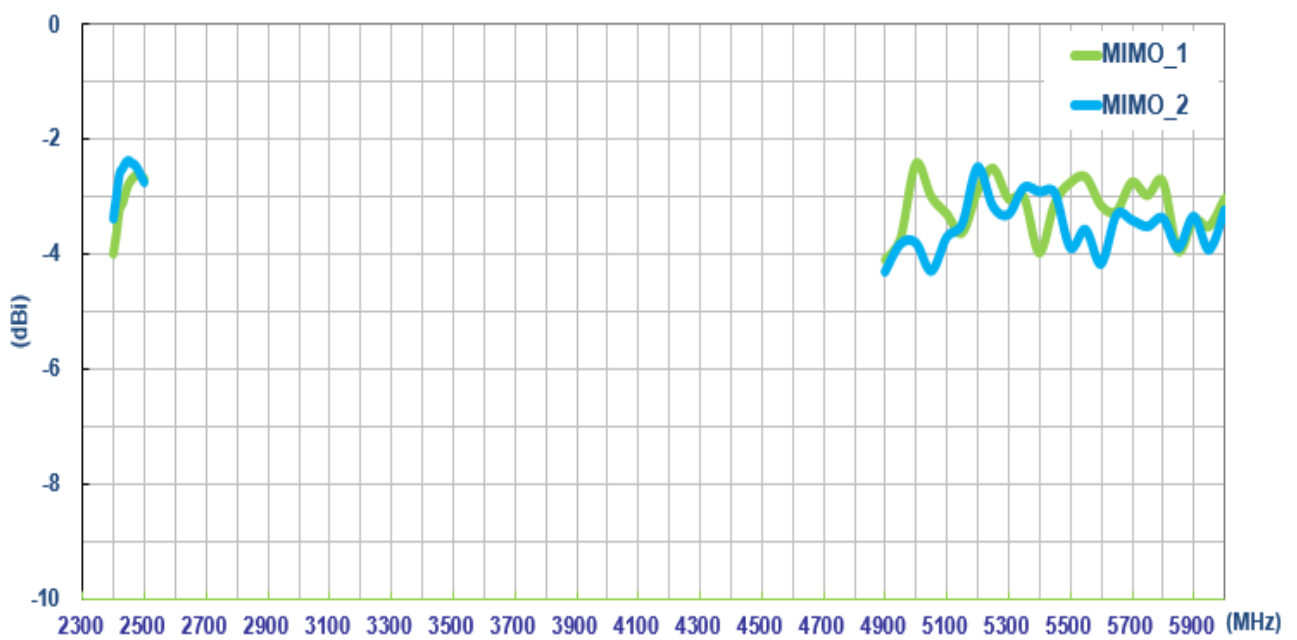

3.21 Wi-Fi – Peak Gain

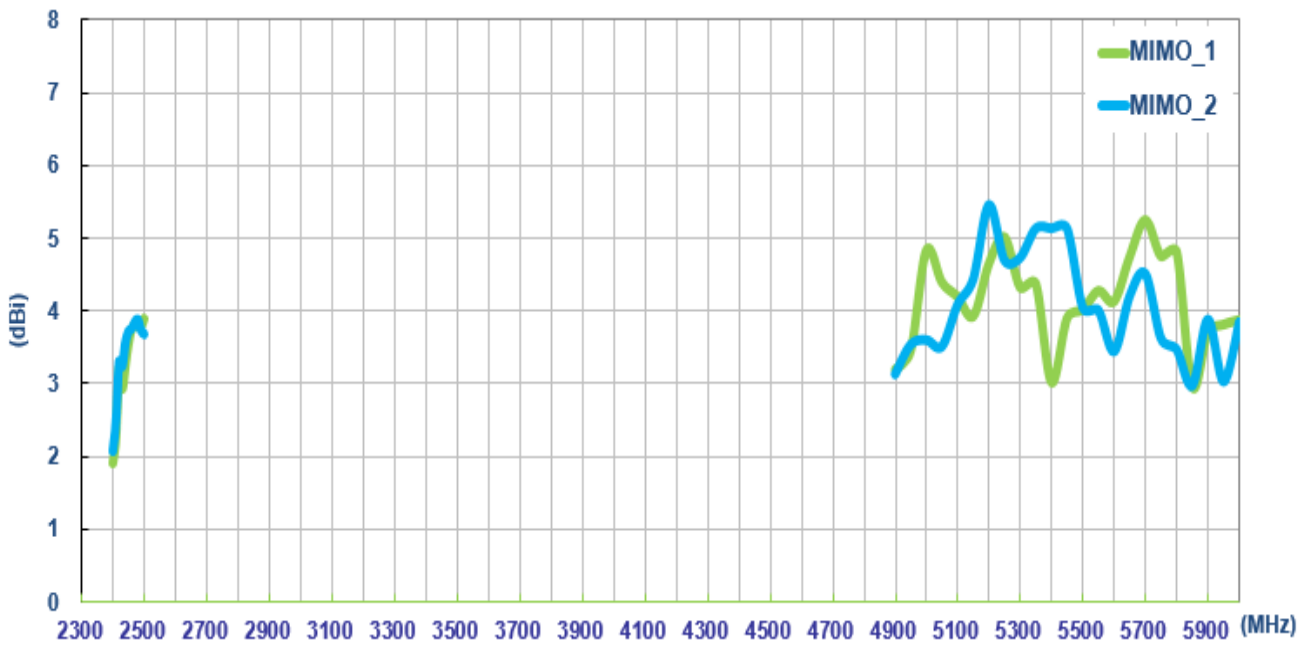

3.22 Wi-Fi – ECC

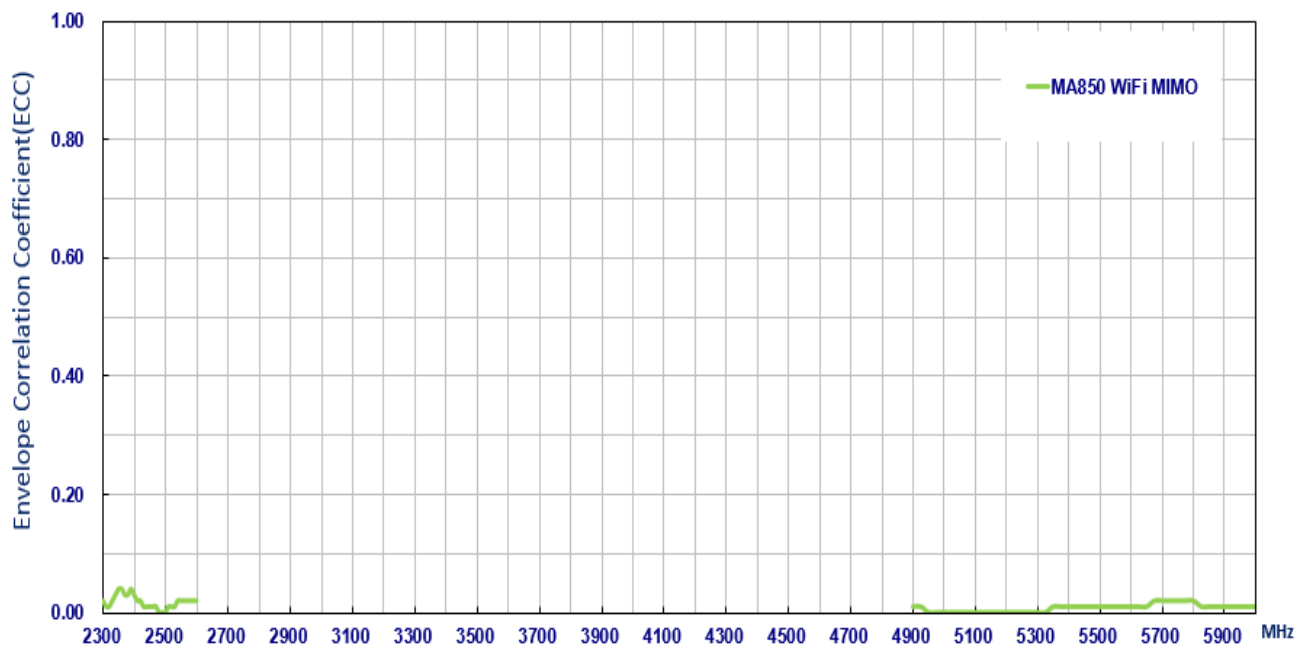

4. Radiation Patterns

4.1 Test Setup

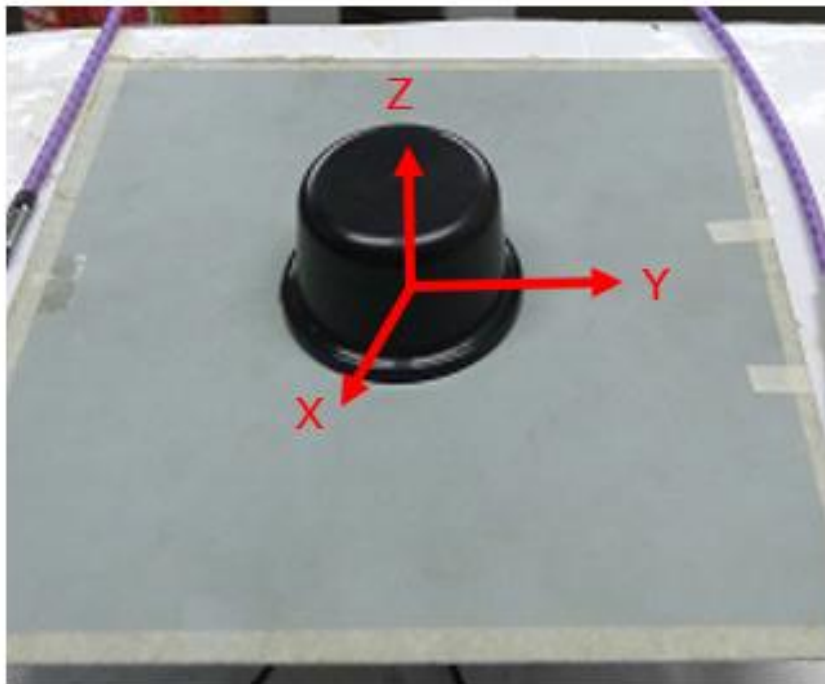

30mm X 30mm Metal Ground Plane

4.2 GNSS - 3D and 2D Radiation Patterns

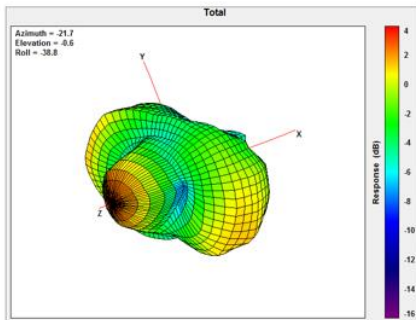

1561MHz

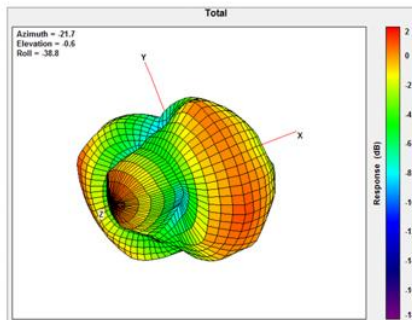

1575.42MHz

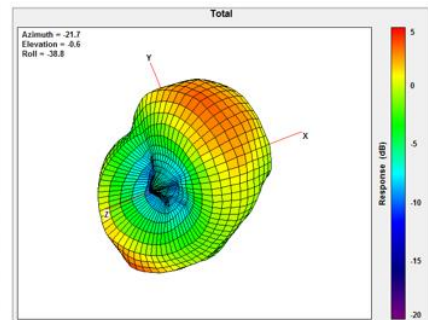

1602MHz

XY Plane

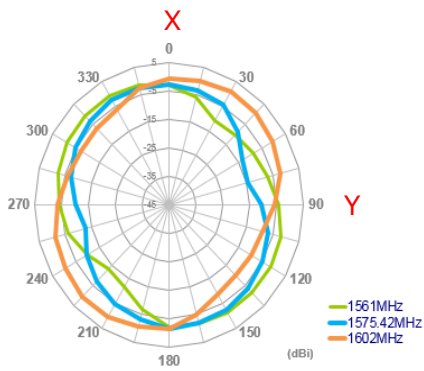

XZ Plane

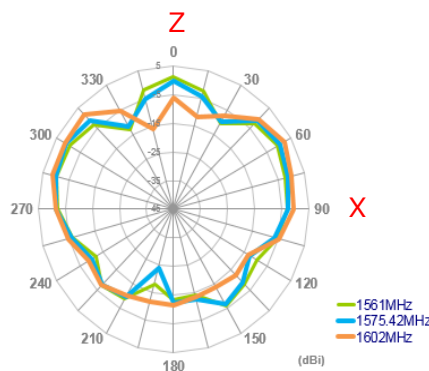

YZ Plane

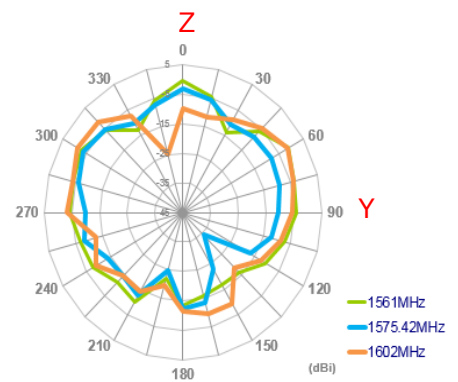

4.3 LTE1 – 705MHz 3D and 2D Radiation Patterns

Azimuth = 0.0
Elevation = 0.0
Roll = -35.0

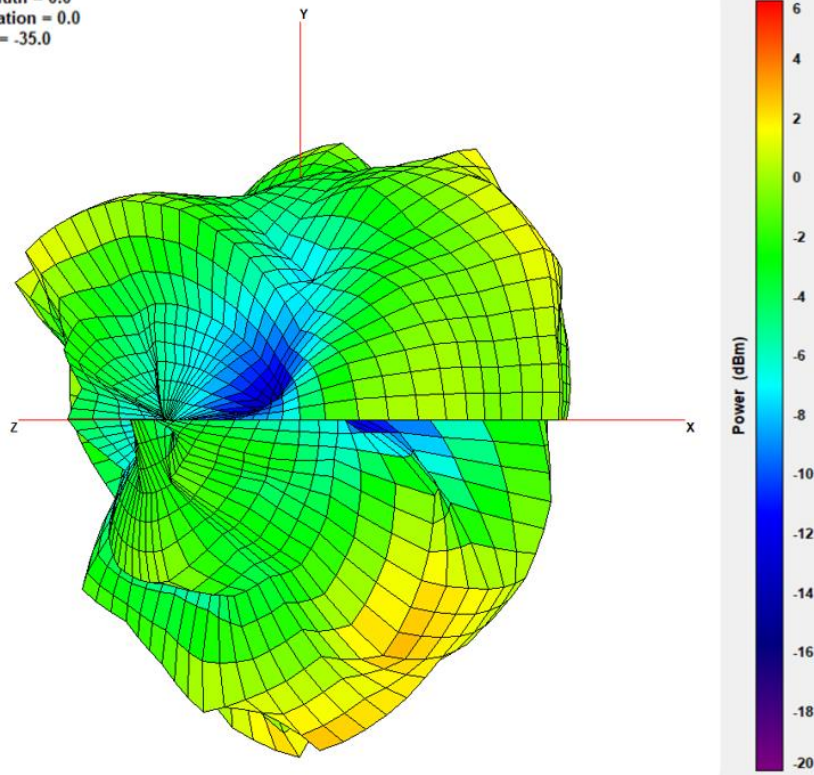

XY Plane

XZ Plane

YZ Plane

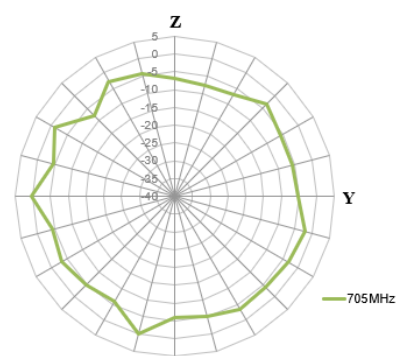
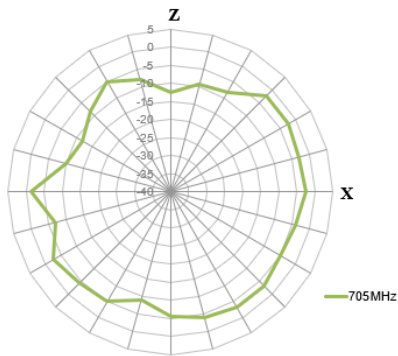
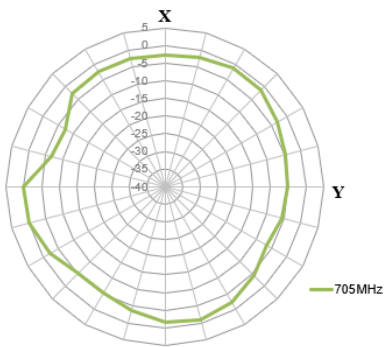

750MHz

Azimuth = 0.0
Elevation = 0.0
Roll = -35.0

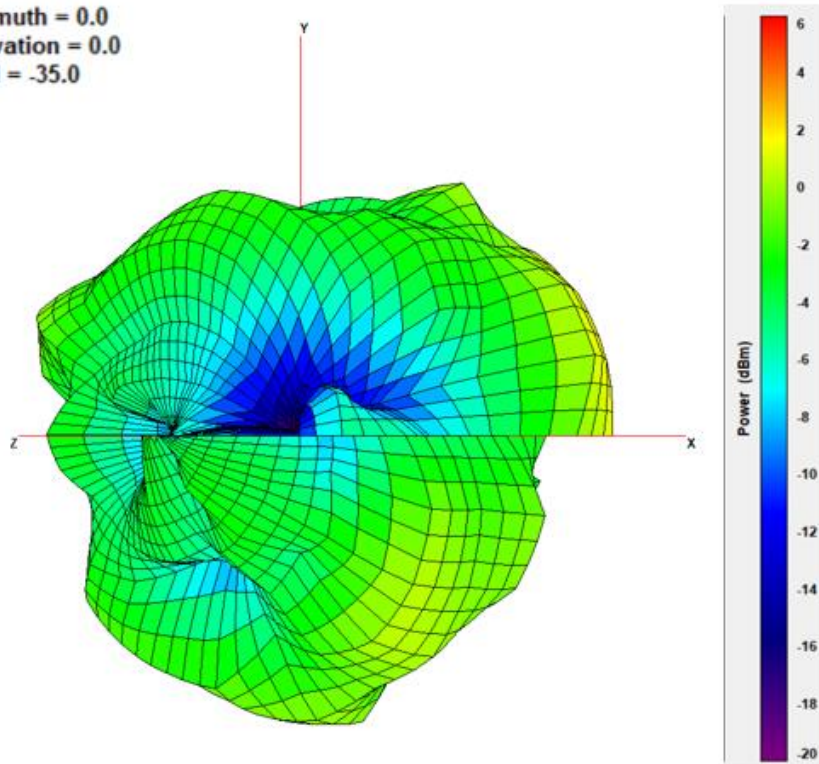

XY Plane

XZ Plane

YZ Plane

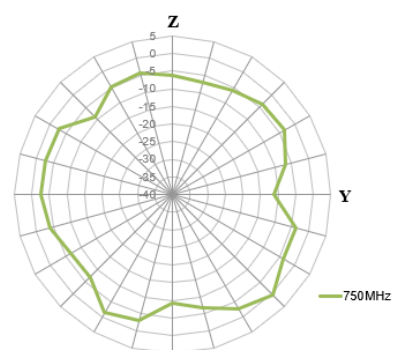
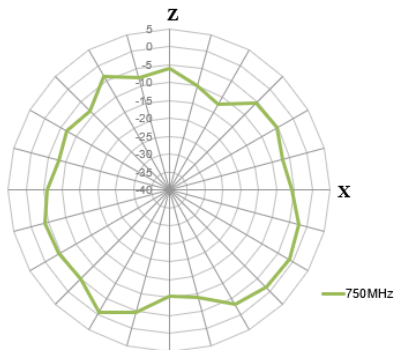
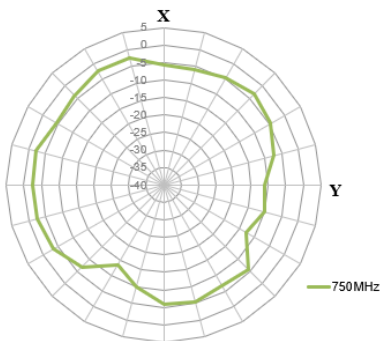

825MHz

Azimuth = 0.0
 Elevation = 0.0
 Roll = -35.0

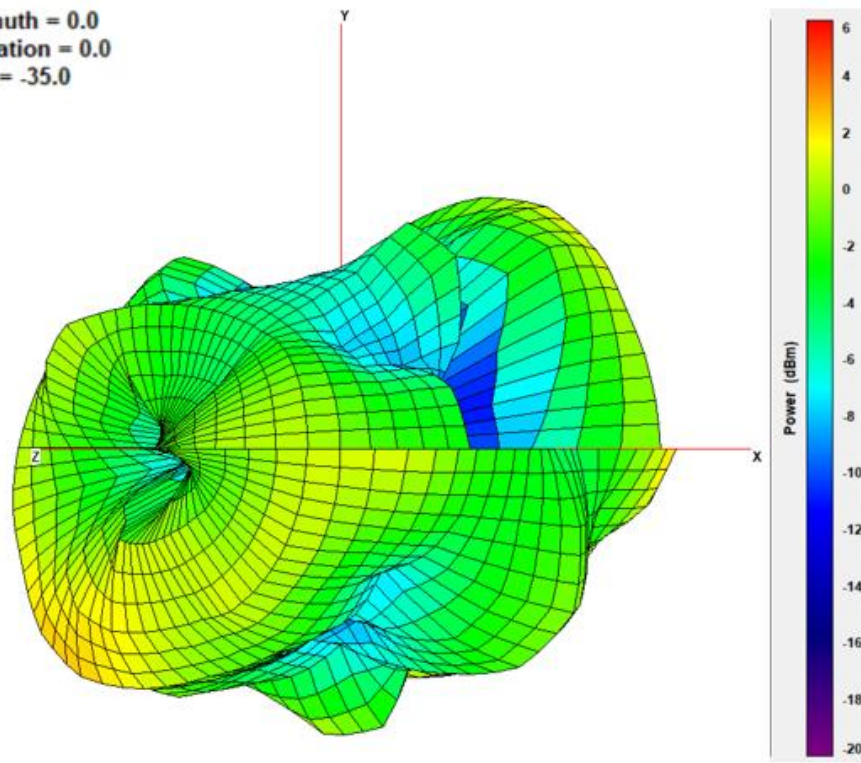

XY Plane

XZ Plane

YZ Plane

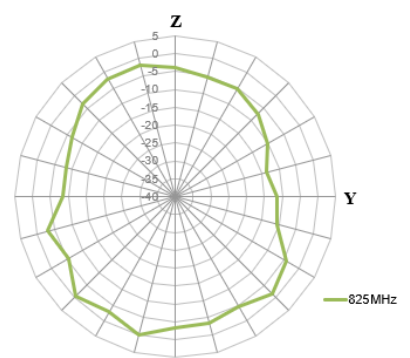
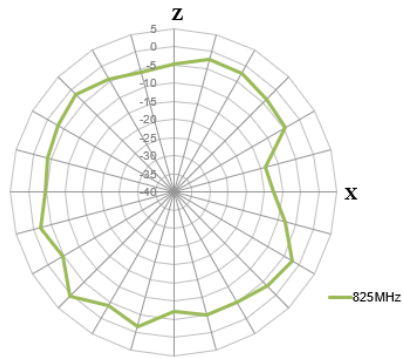
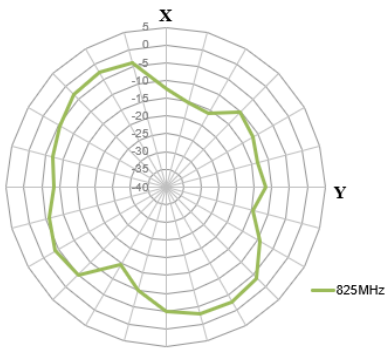

880MHz

Azimuth = 0.0
Elevation = 0.0
Roll = -35.0

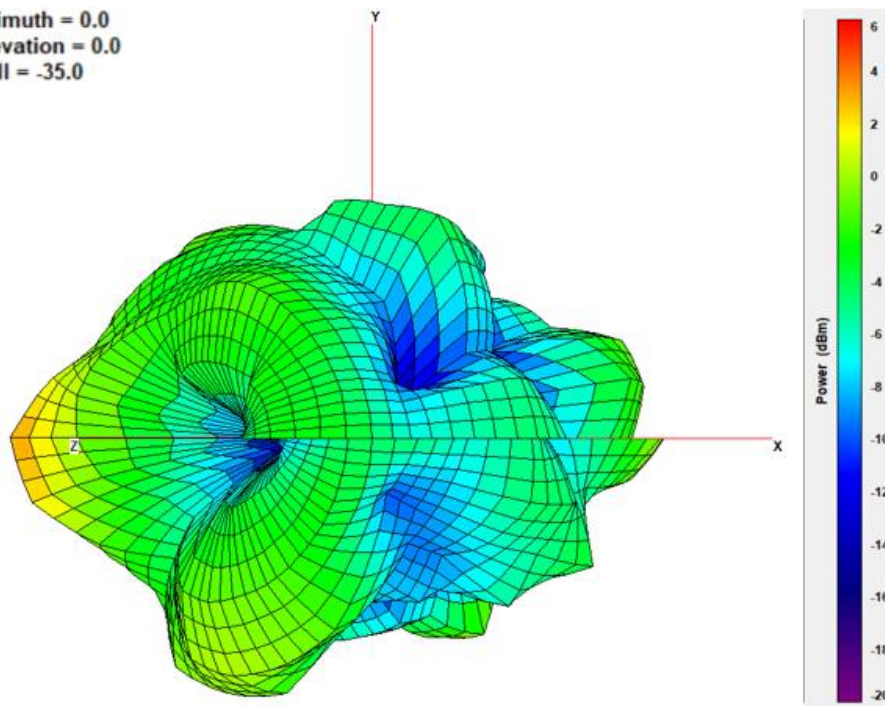

XY Plane

XZ Plane

YZ Plane

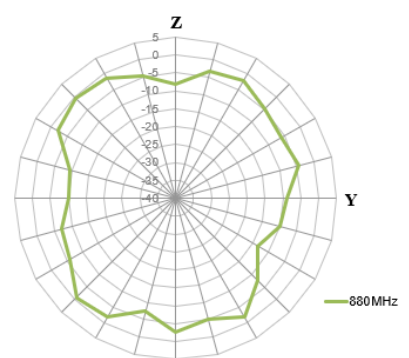
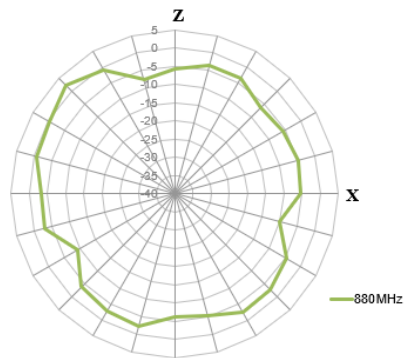
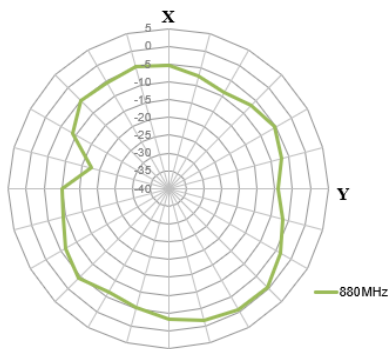

960MHz

Azimuth = 0.0
Elevation = 0.0
Roll = -35.0

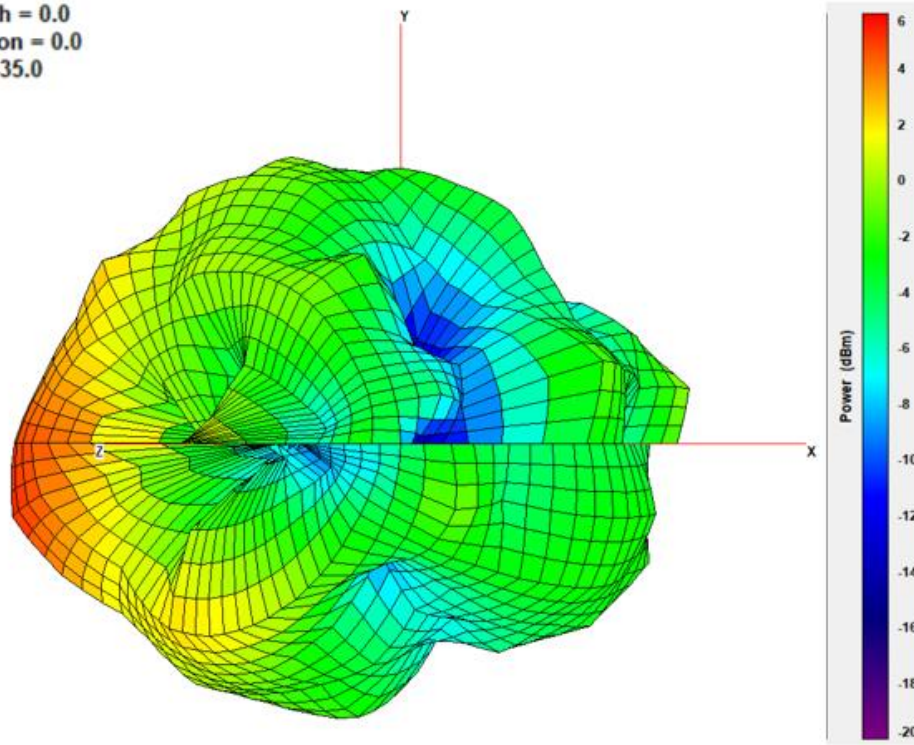

XY Plane

XZ Plane

YZ Plane

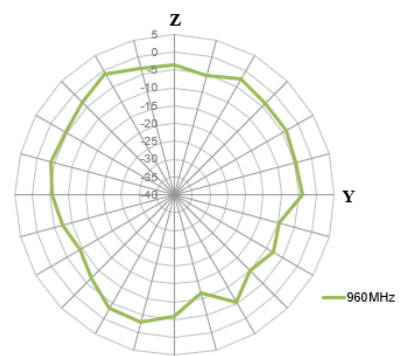
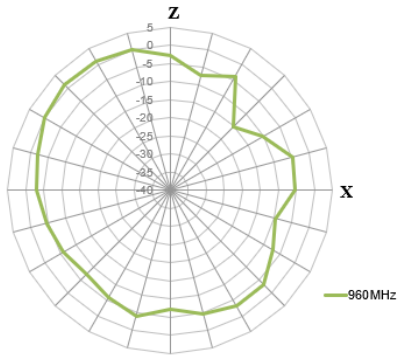
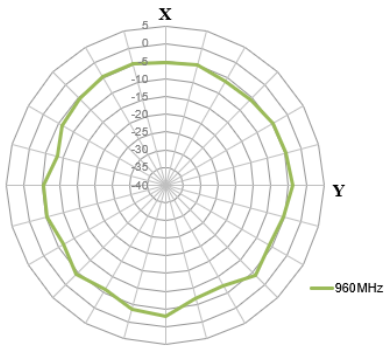

1710MHz

Azimuth = 0.0
Elevation = 0.0
Roll = -35.0

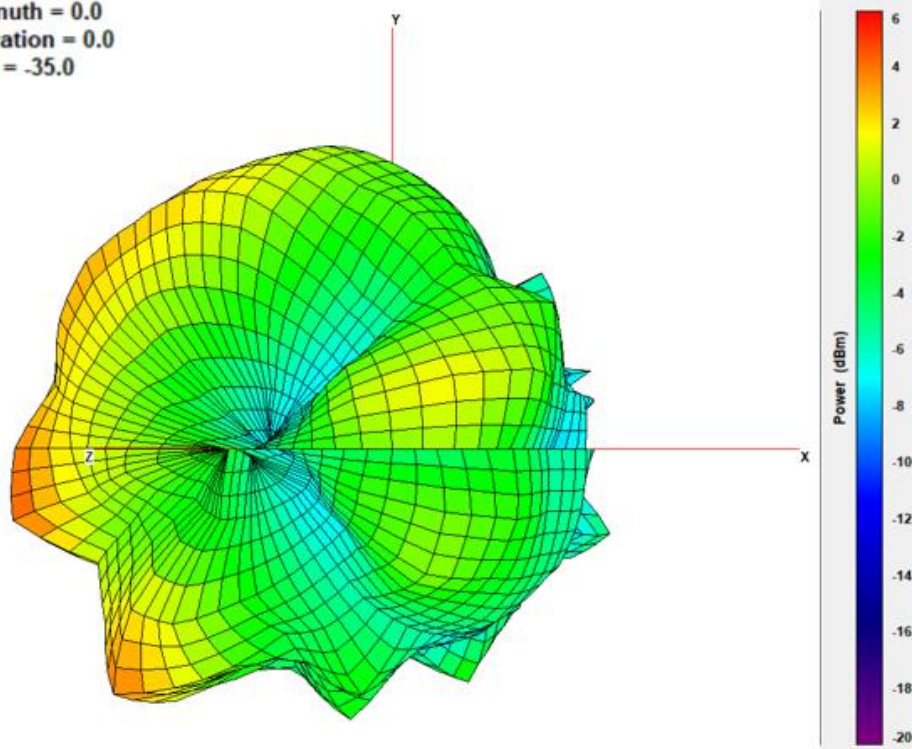

XY Plane

XZ Plane

YZ Plane

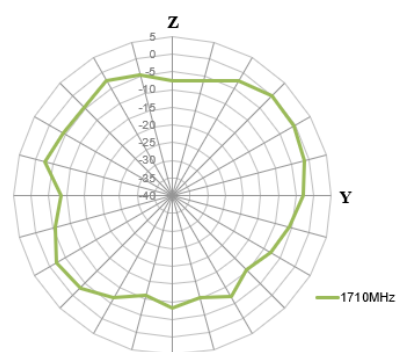
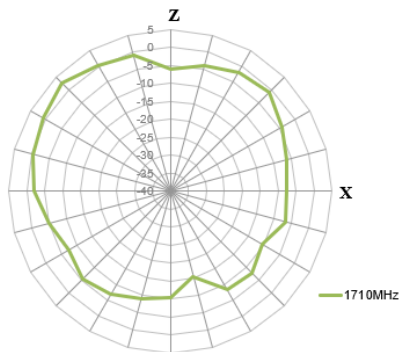
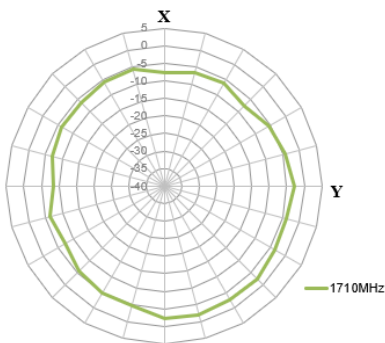

1880MHz

Azimuth = 0.0
Elevation = 0.0
Roll = -35.0

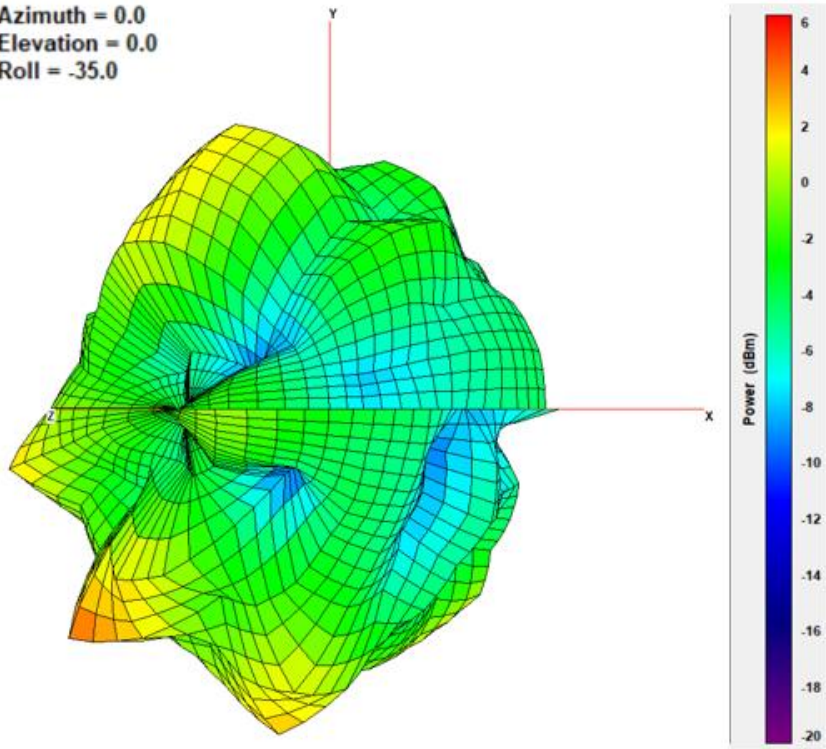

XY Plane

XZ Plane

YZ Plane

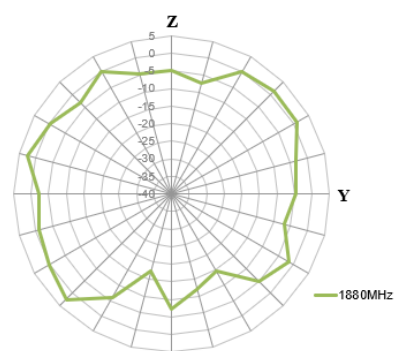
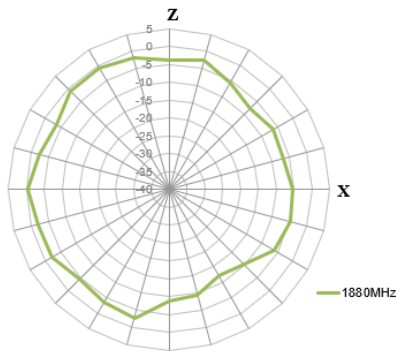
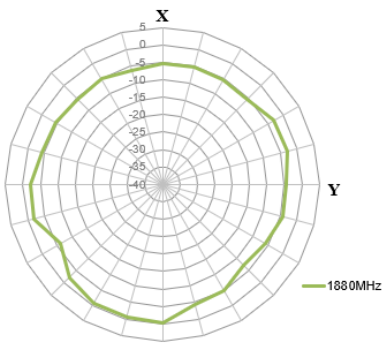

1990MHz

Azimuth = 0.0
Elevation = 0.0
Roll = -35.0

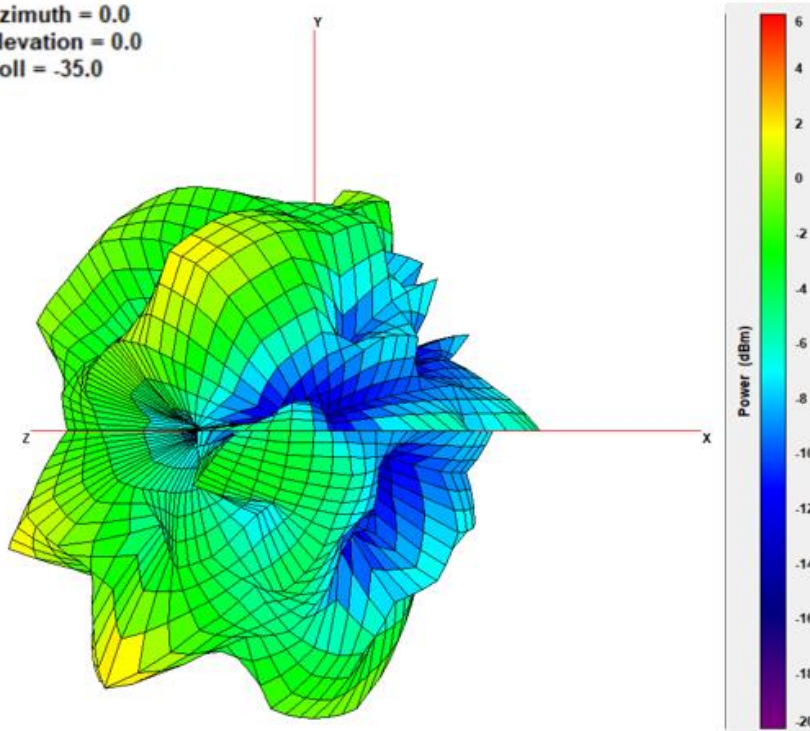

XY Plane

XZ Plane

YZ Plane

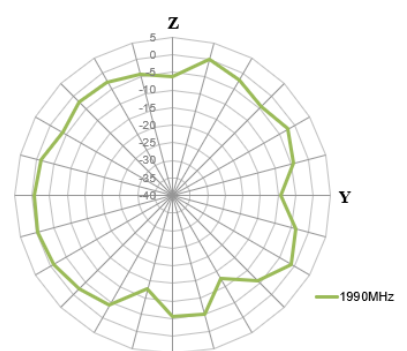
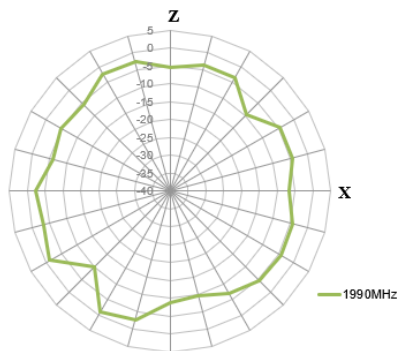
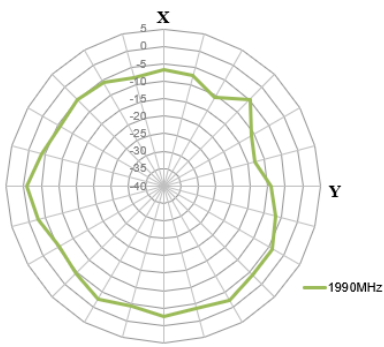

2170MHz

Azimuth = 0.0
Elevation = 0.0
Roll = -35.0

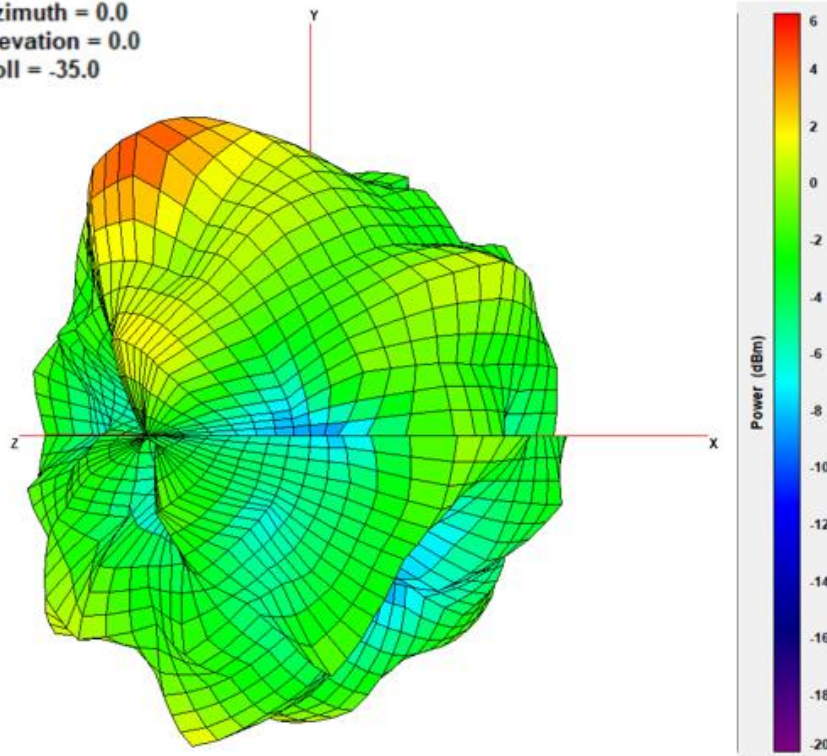

XY Plane

XZ Plane

YZ Plane

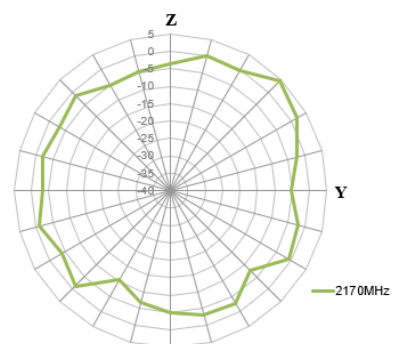
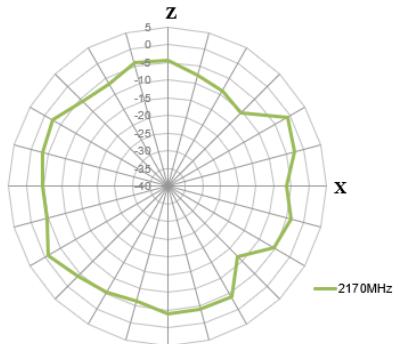
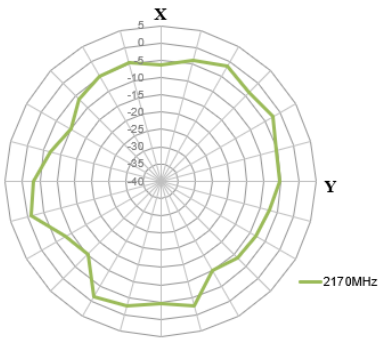

2300MHz

Azimuth = 0.0
Elevation = 0.0
Roll = -35.0

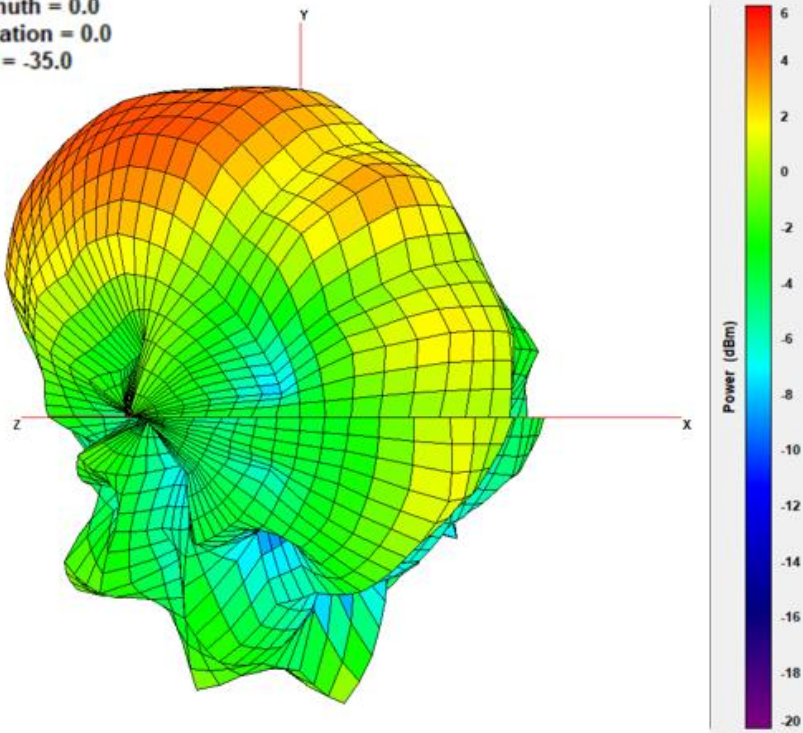

XY Plane

XZ Plane

YZ Plane

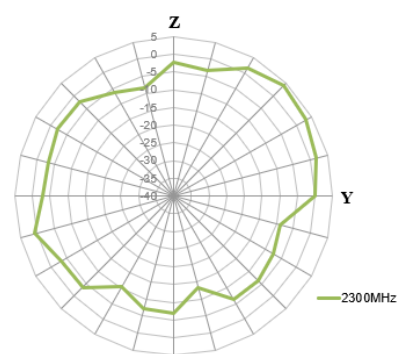
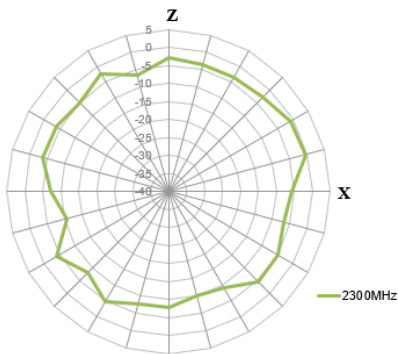
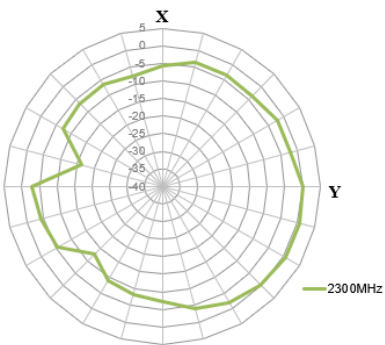

2500MHz

Azimuth = 0.0
 Elevation = 0.0
 Roll = -35.0

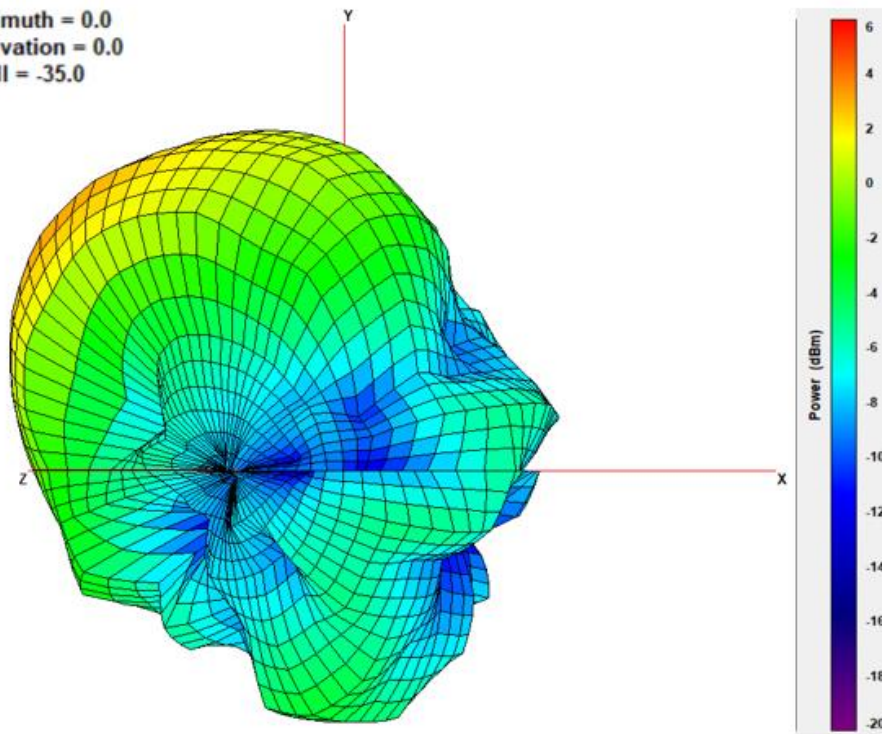

XY Plane

XZ Plane

YZ Plane

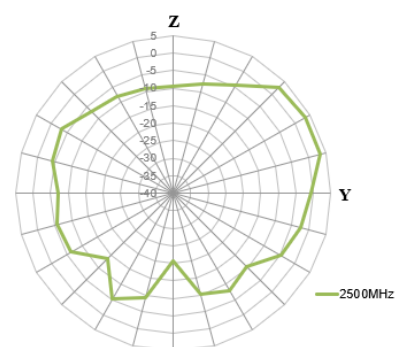
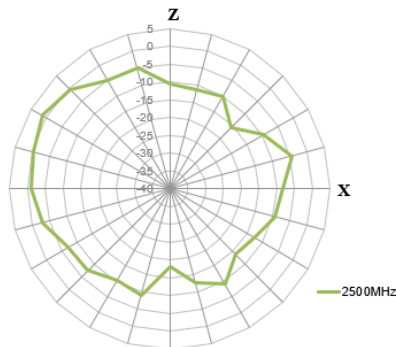
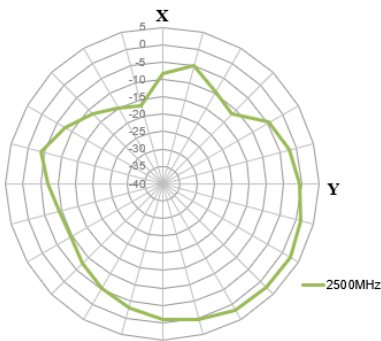

2700MHz

Azimuth = 0.0
Elevation = 0.0
Roll = -35.0

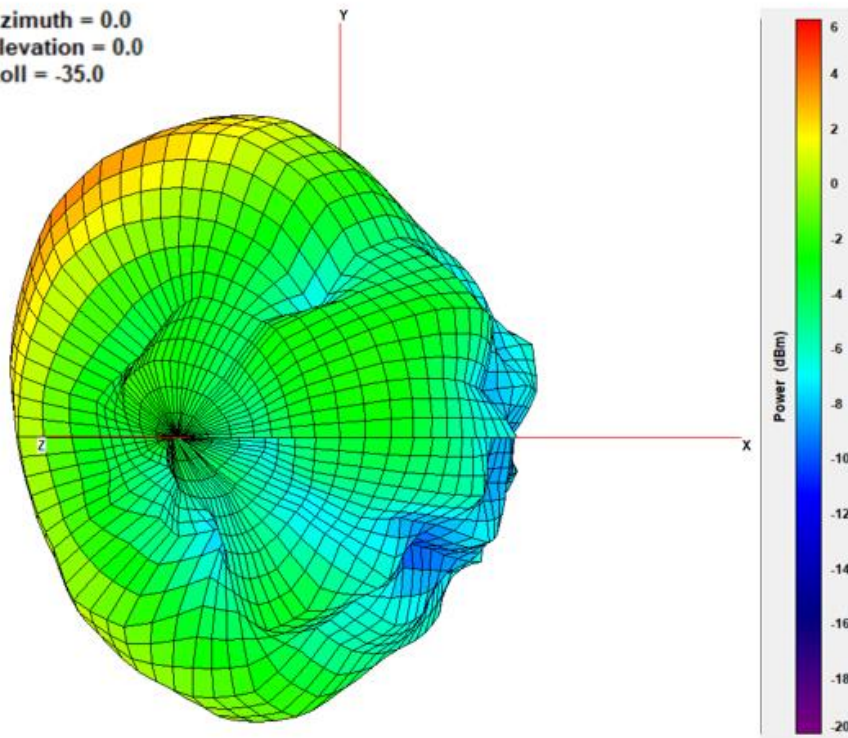

XY Plane

XZ Plane

YZ Plane

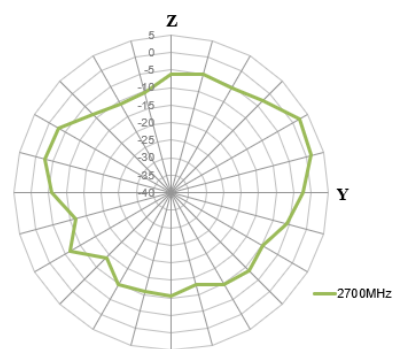
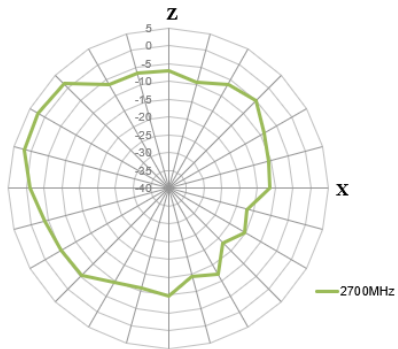
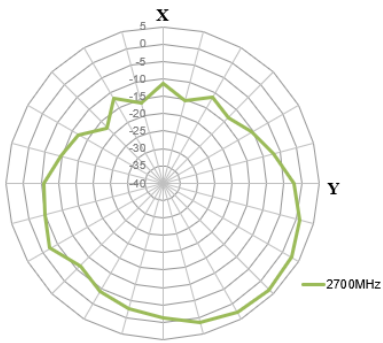

3200MHz

Azimuth = 0.0
Elevation = 0.0
Roll = -35.0

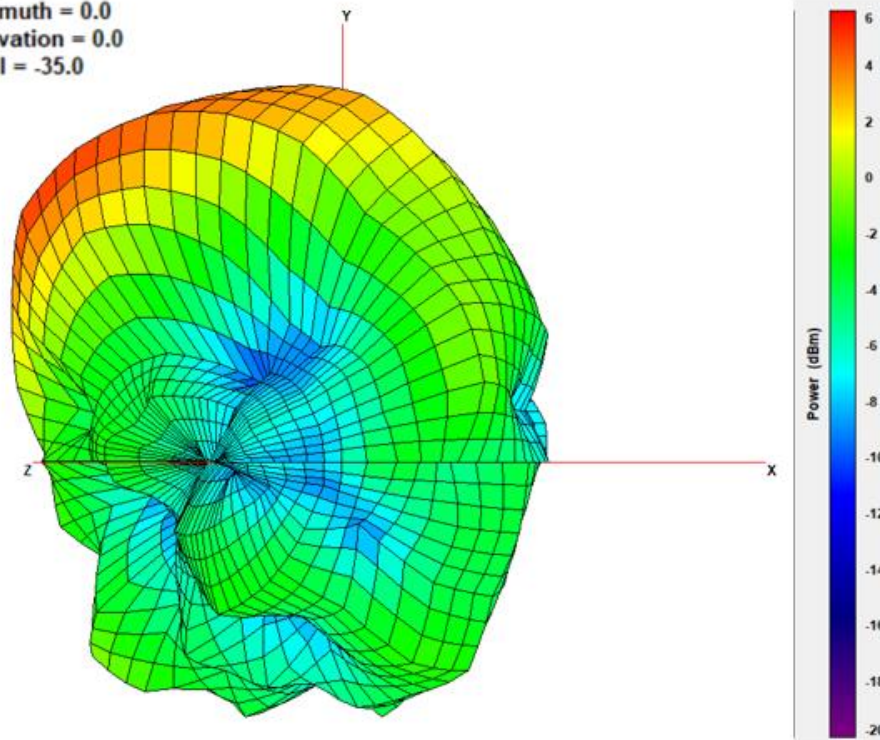

XY Plane

XZ Plane

YZ Plane

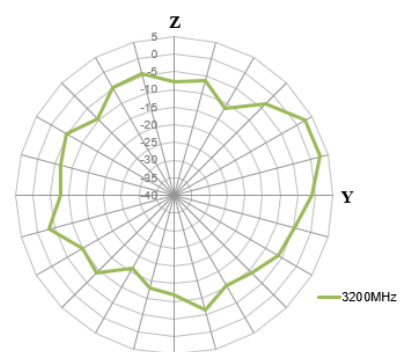
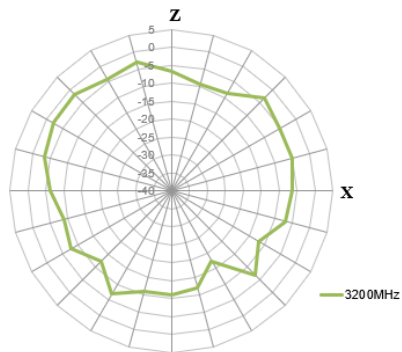
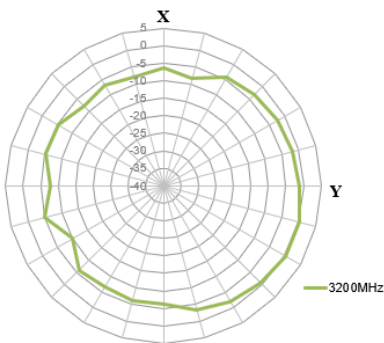

4200MHz

Azimuth = 0.0
Elevation = 0.0
Roll = -35.0

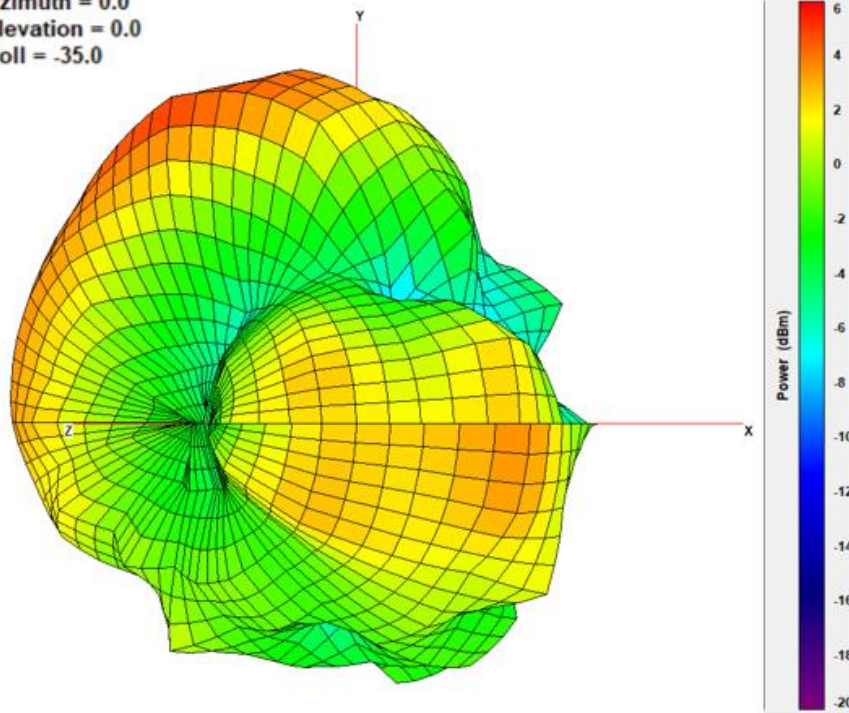

XY Plane

XZ Plane

YZ Plane

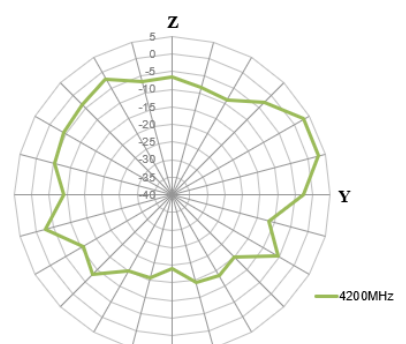
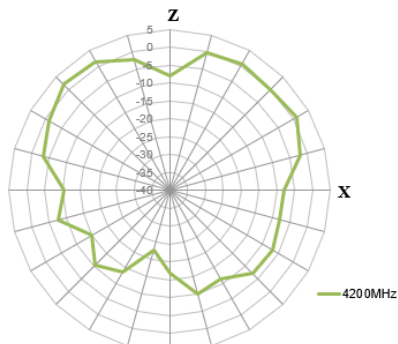
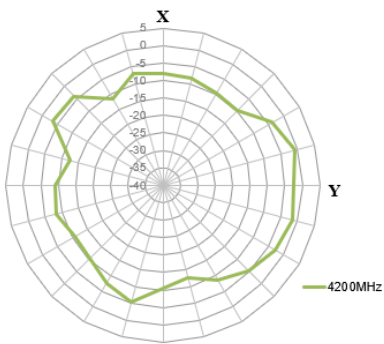

5150MHz

Azimuth = 0.0
Elevation = 0.0
Roll = -35.0

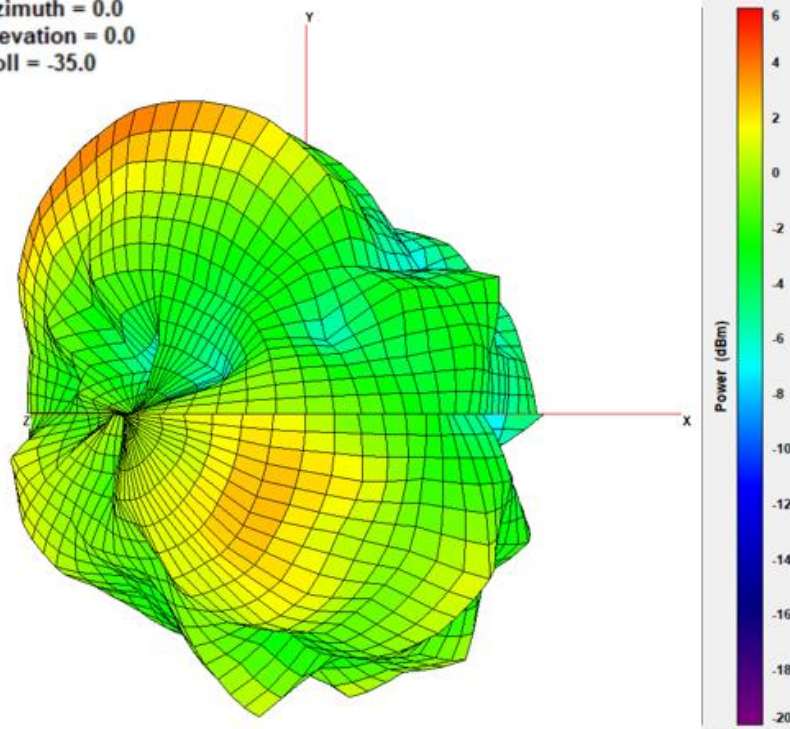

XY Plane

XZ Plane

YZ Plane

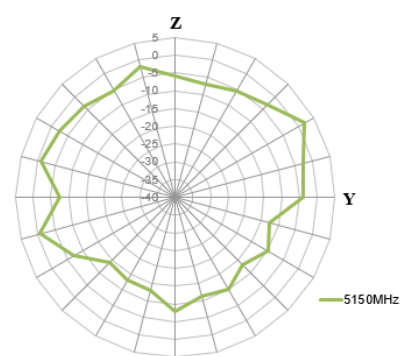
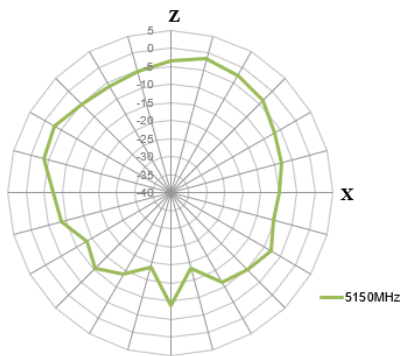
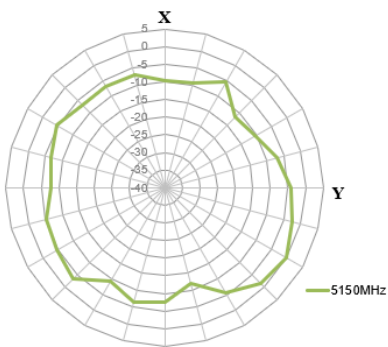

5550MHz

Azimuth = 0.0
 Elevation = 0.0
 Roll = -35.0

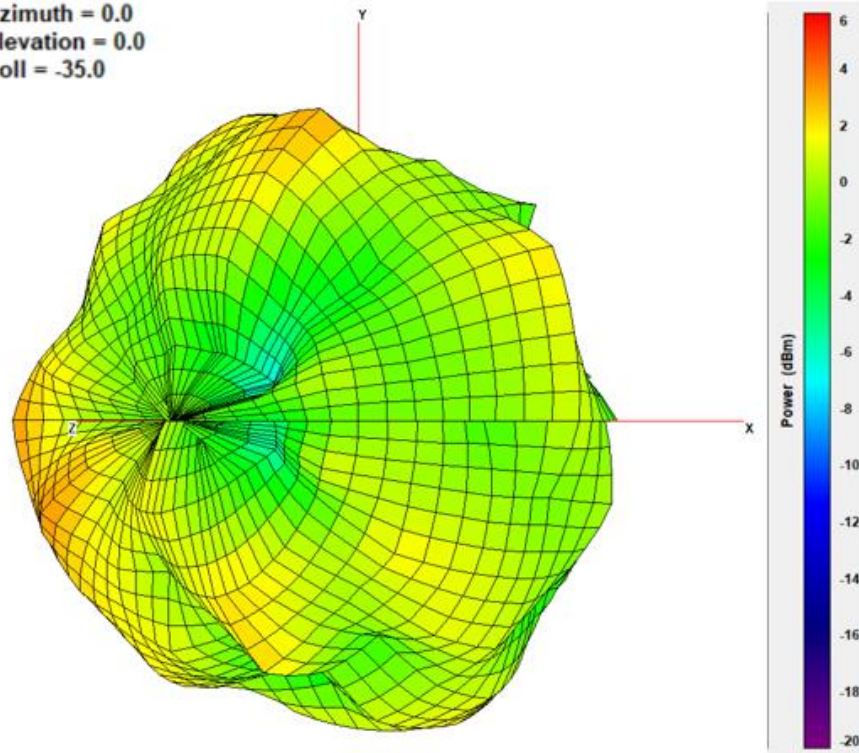

XY Plane

XZ Plane

YZ Plane

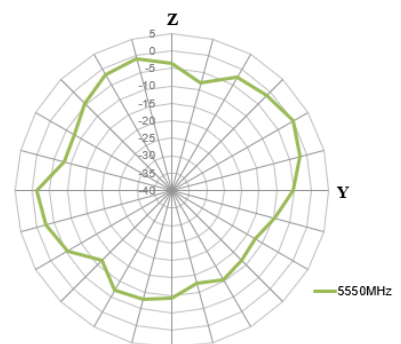
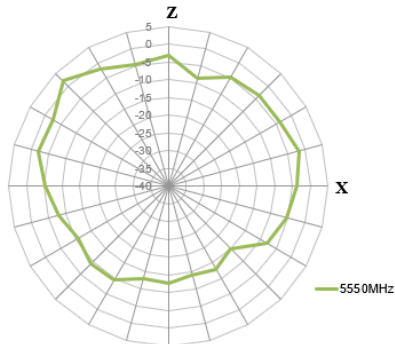
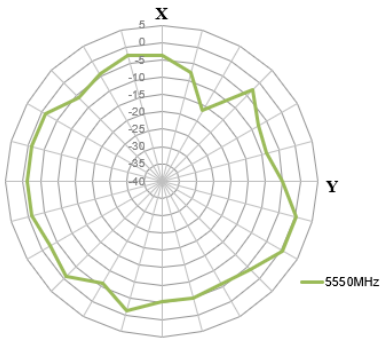

4.4 LTE2 – 705MHz 3D and 2D Radiation Patterns

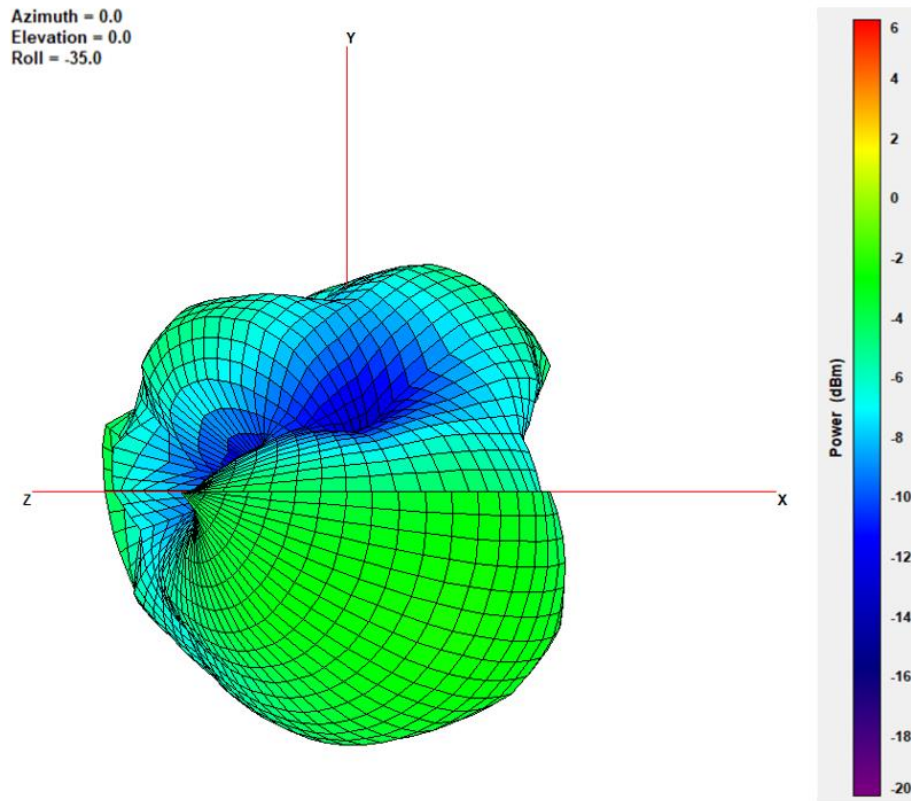

XY Plane

XZ Plane

YZ Plane

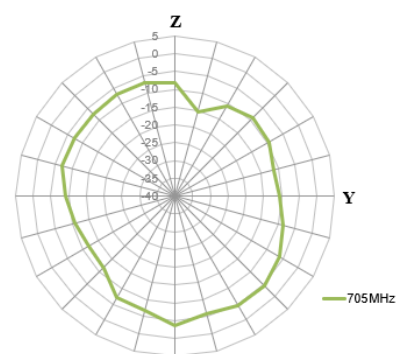
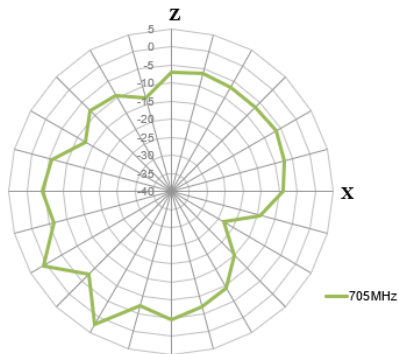
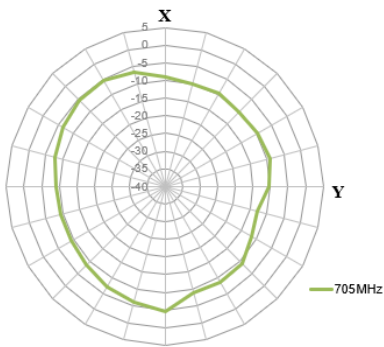

750MHz

Azimuth = 0.0
Elevation = 0.0
Roll = -35.0

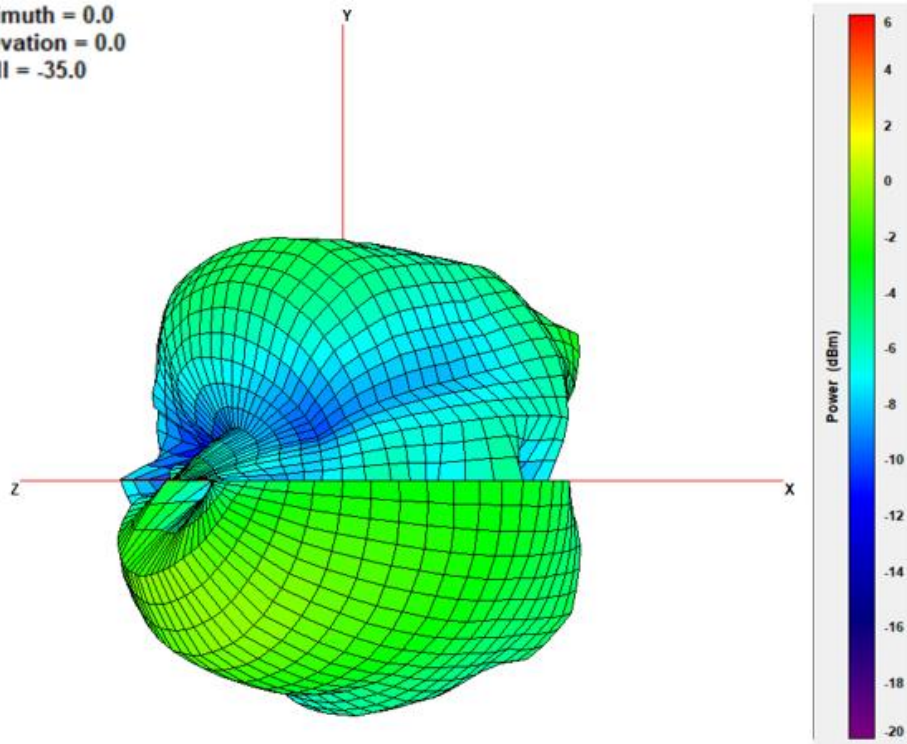

XY Plane

XZ Plane

YZ Plane

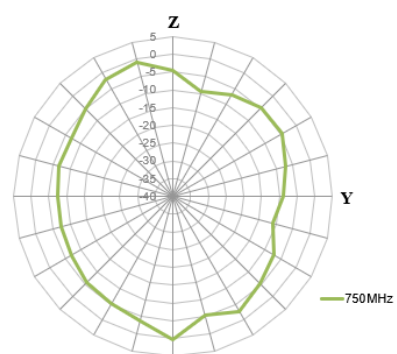
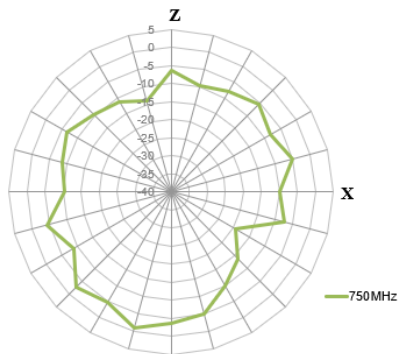
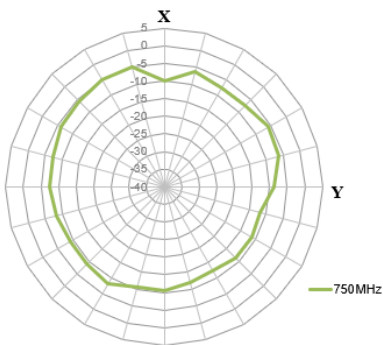

825MHz

Azimuth = 0.0
 Elevation = 0.0
 Roll = -35.0

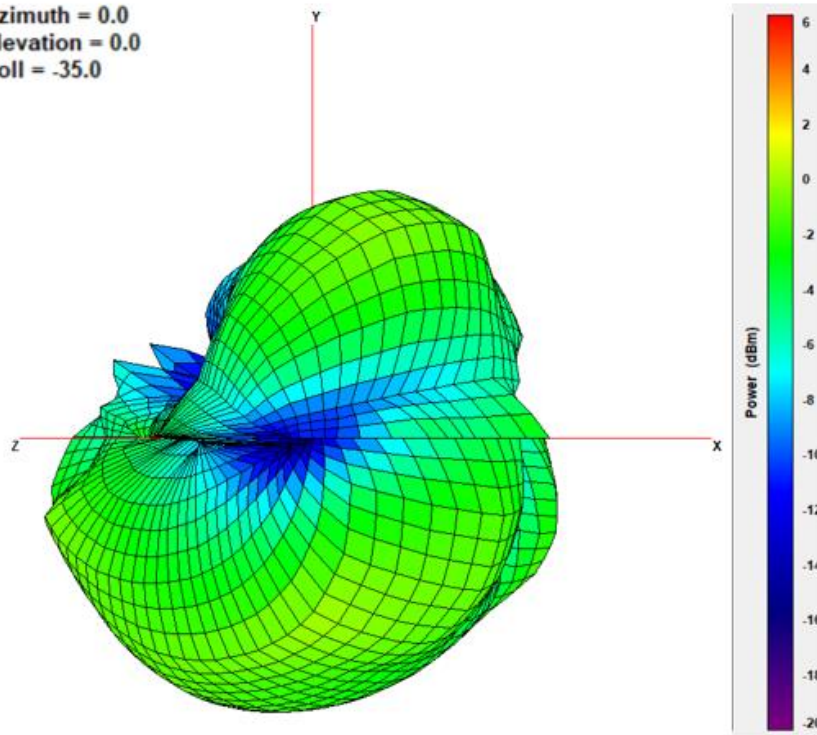

XY Plane

XZ Plane

YZ Plane

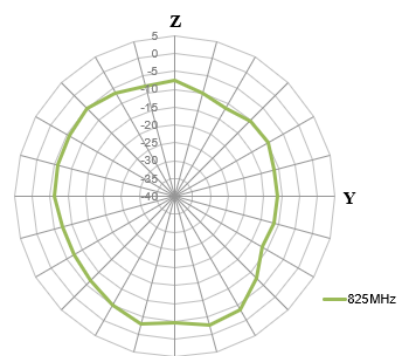
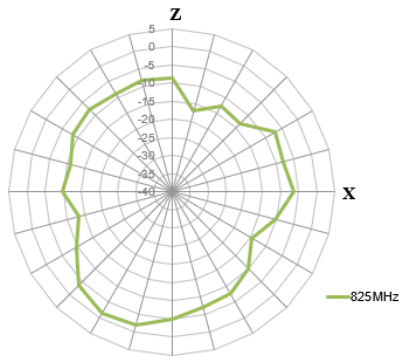
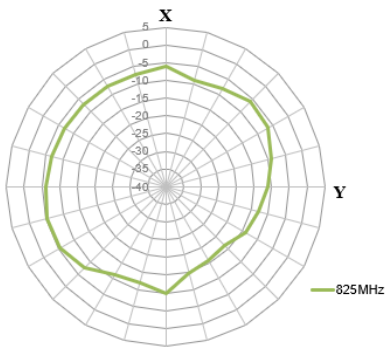

880MHz

Azimuth = 0.0
Elevation = 0.0
Roll = -35.0

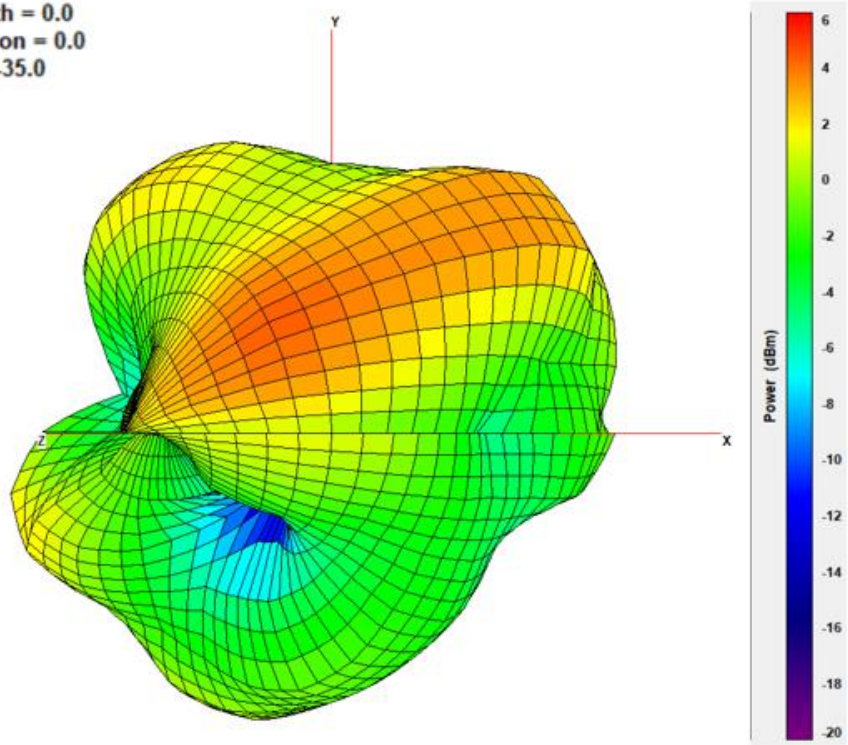

XY Plane

XZ Plane

YZ Plane

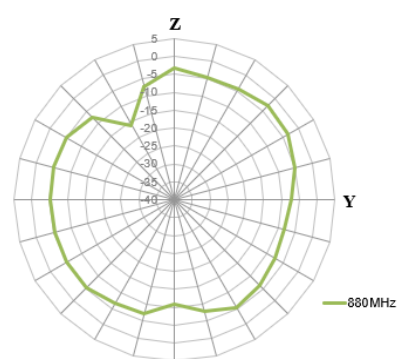
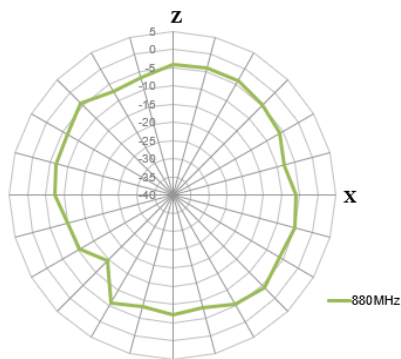
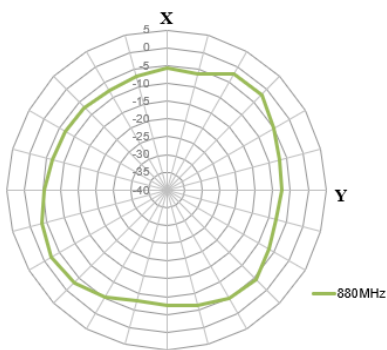

960MHz

Azimuth = 0.0
Elevation = 0.0
Roll = -35.0

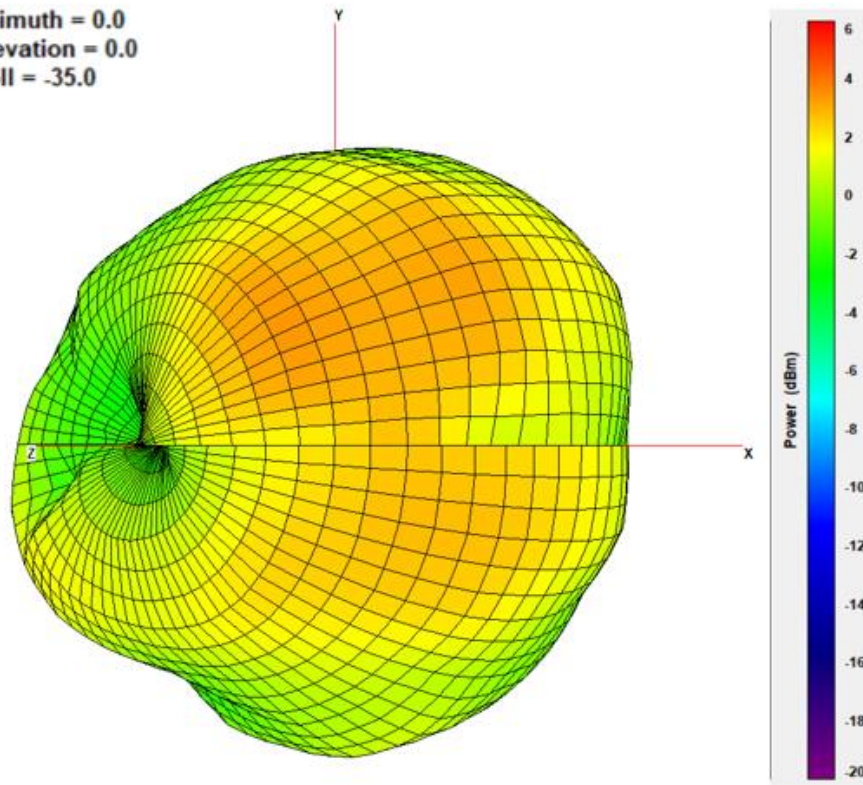

XY Plane

XZ Plane

YZ Plane

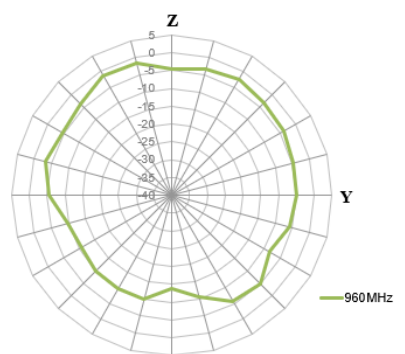
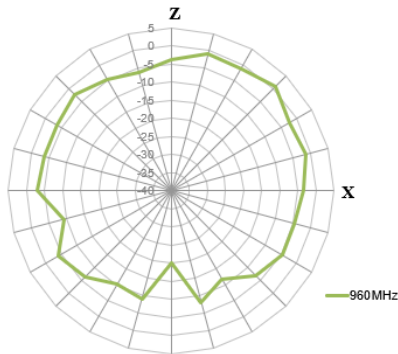
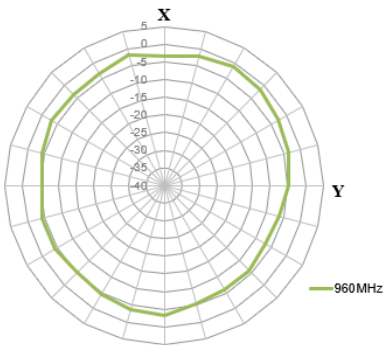

1710MHz

Azimuth = 0.0
Elevation = 0.0
Roll = -35.0

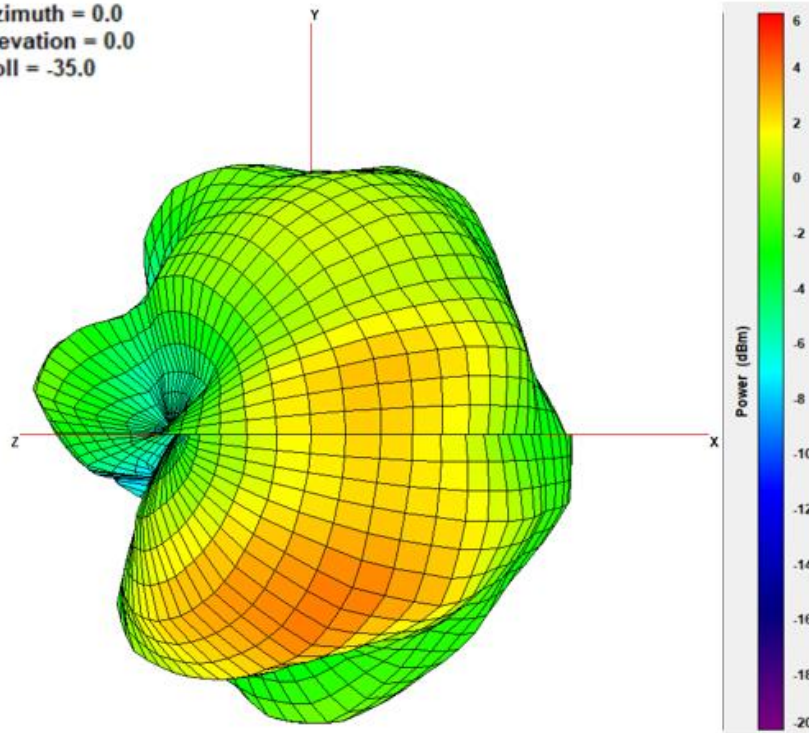

XY Plane

XZ Plane

YZ Plane

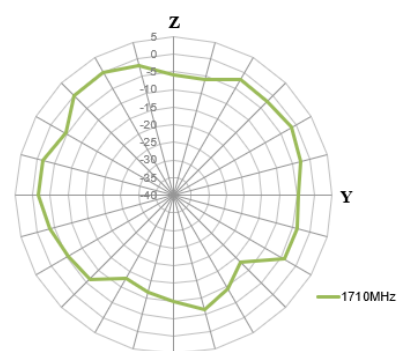
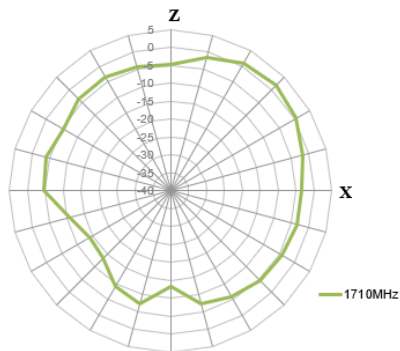
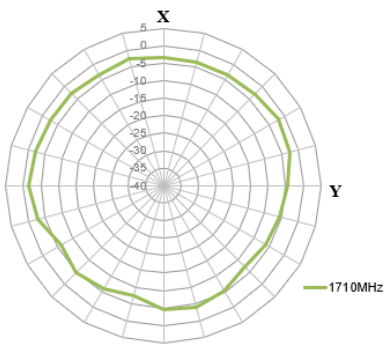

1880MHz

Azimuth = 0.0
Elevation = 0.0
Roll = -35.0

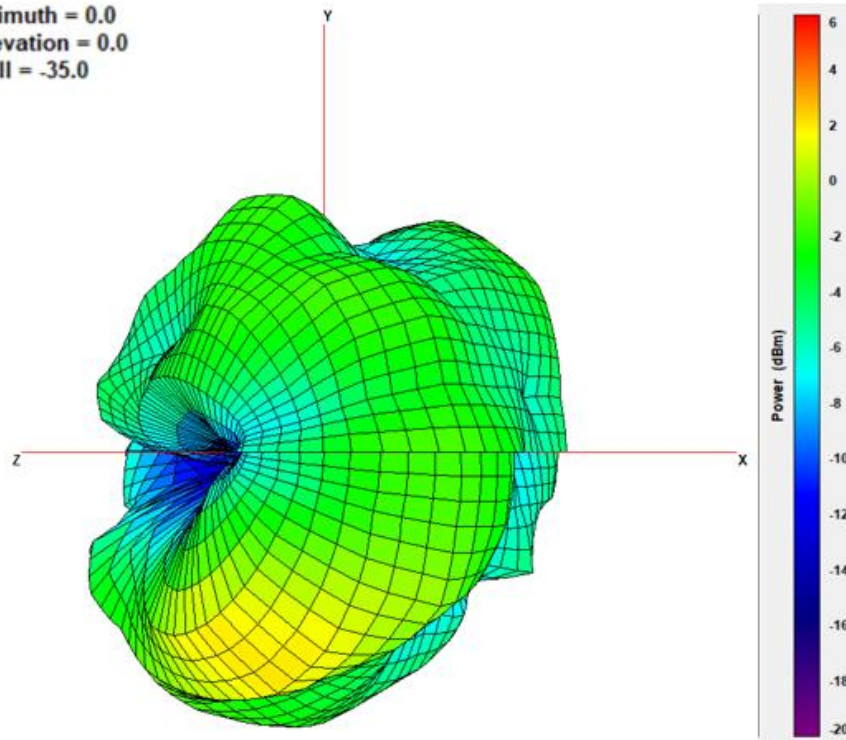

XY Plane

XZ Plane

YZ Plane

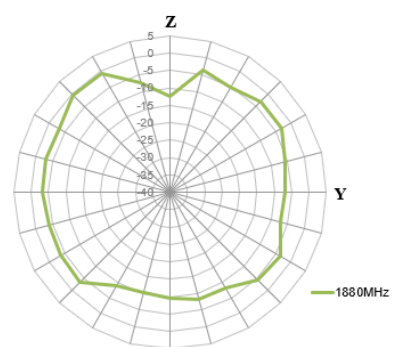
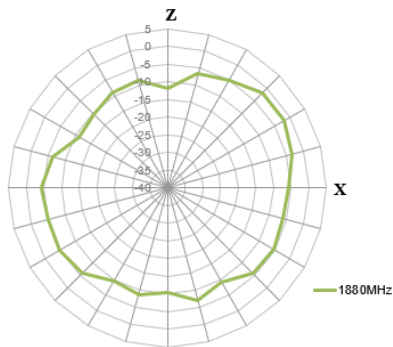
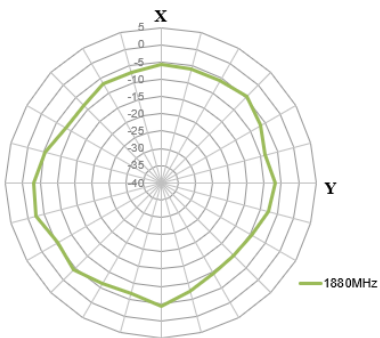

1990MHz

Azimuth = 0.0
Elevation = 0.0
Roll = -35.0

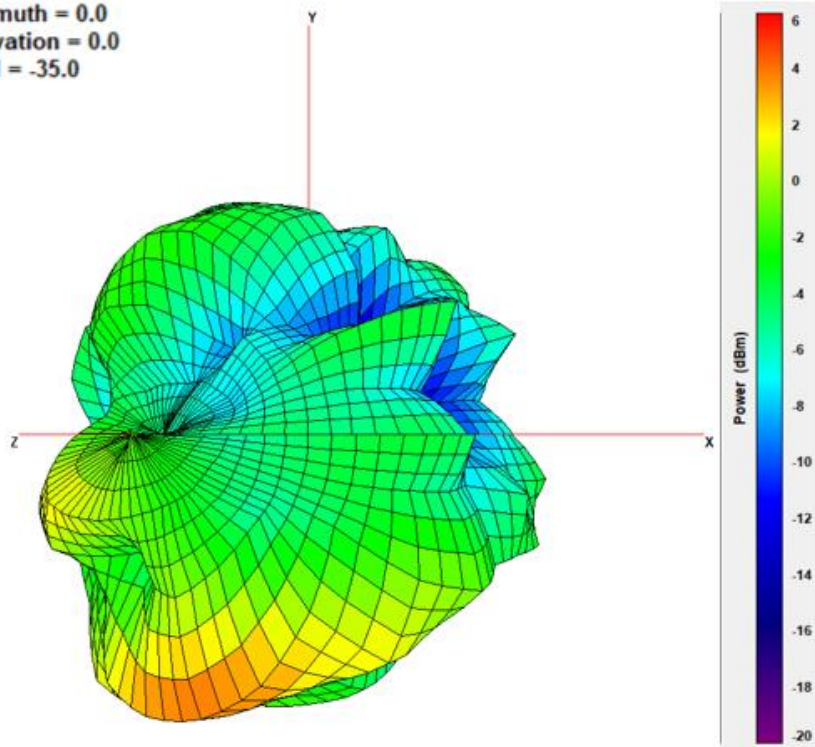

XY Plane

XZ Plane

YZ Plane

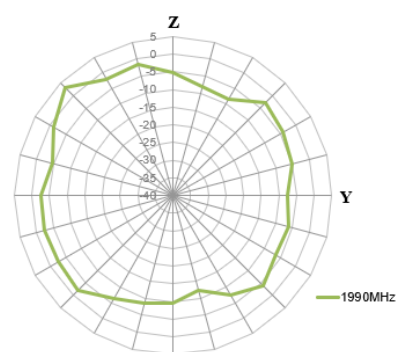
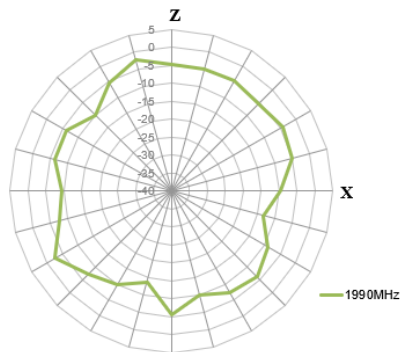
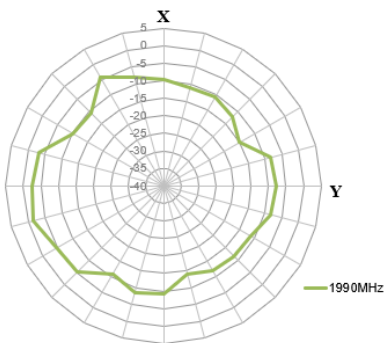

2170MHz

Azimuth = 0.0
Elevation = 0.0
Roll = -35.0

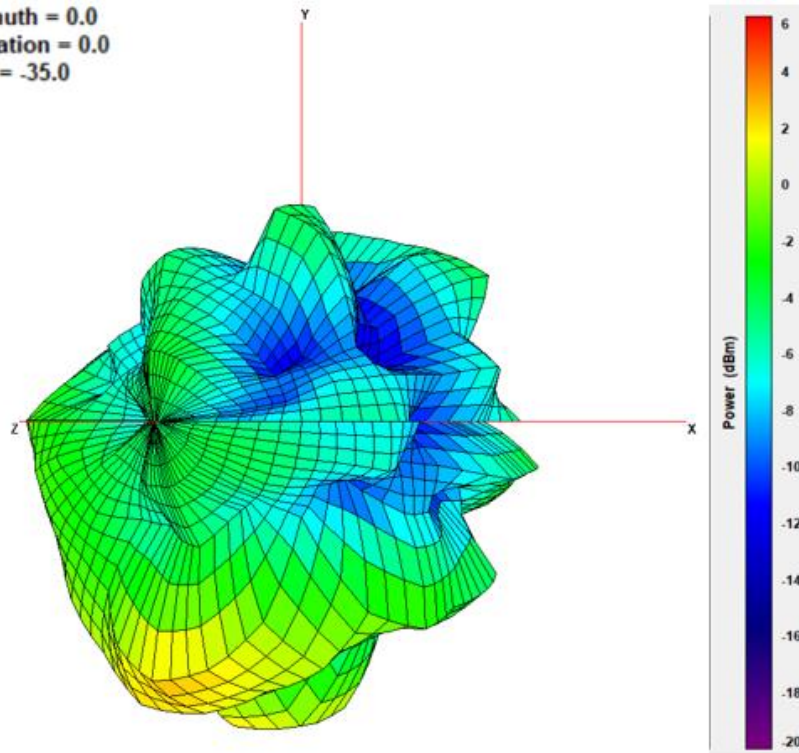

XY Plane

XZ Plane

YZ Plane

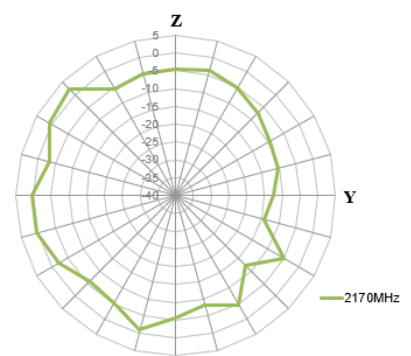
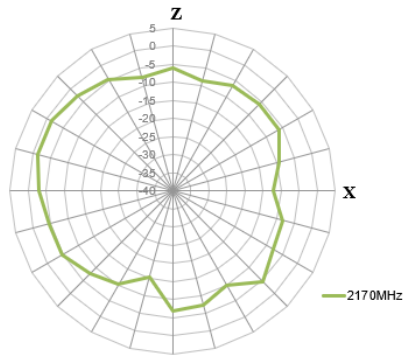
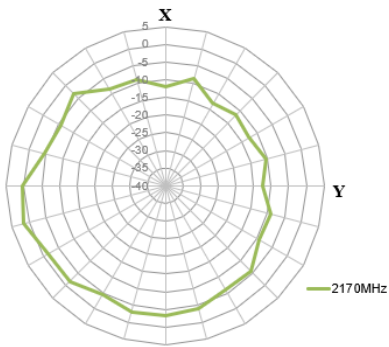

2300MHz

Azimuth = 0.0
Elevation = 0.0
Roll = -35.0

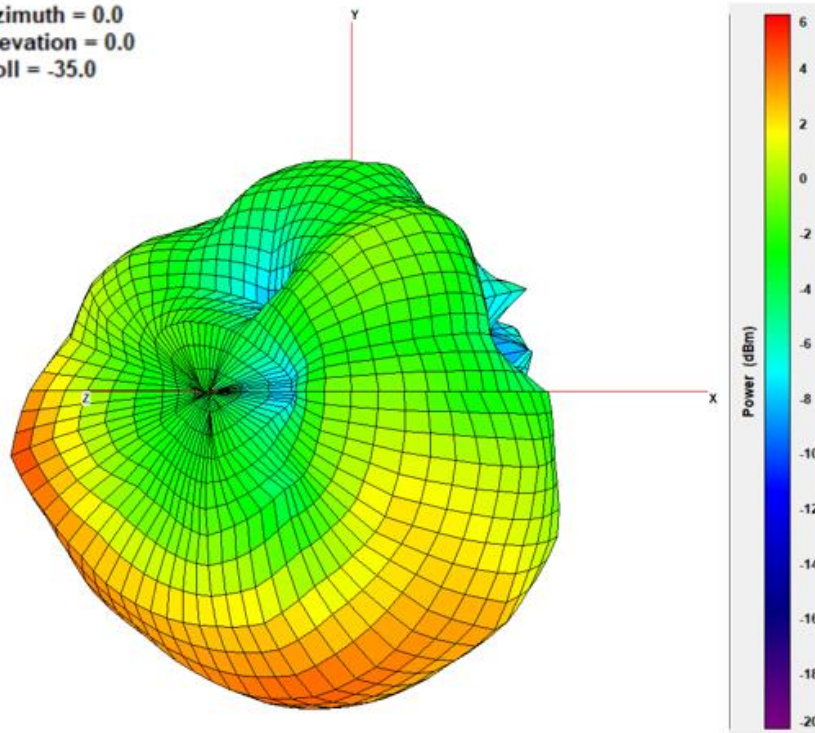

XY Plane

XZ Plane

YZ Plane

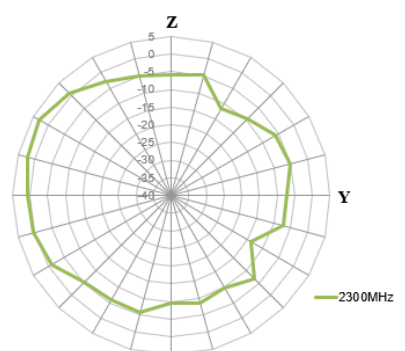
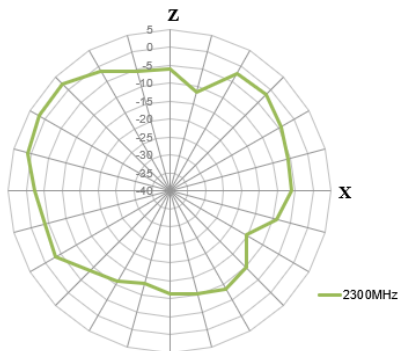
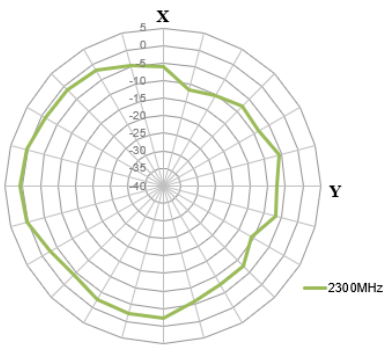

2500MHz

Azimuth = 0.0
Elevation = 0.0
Roll = -35.0

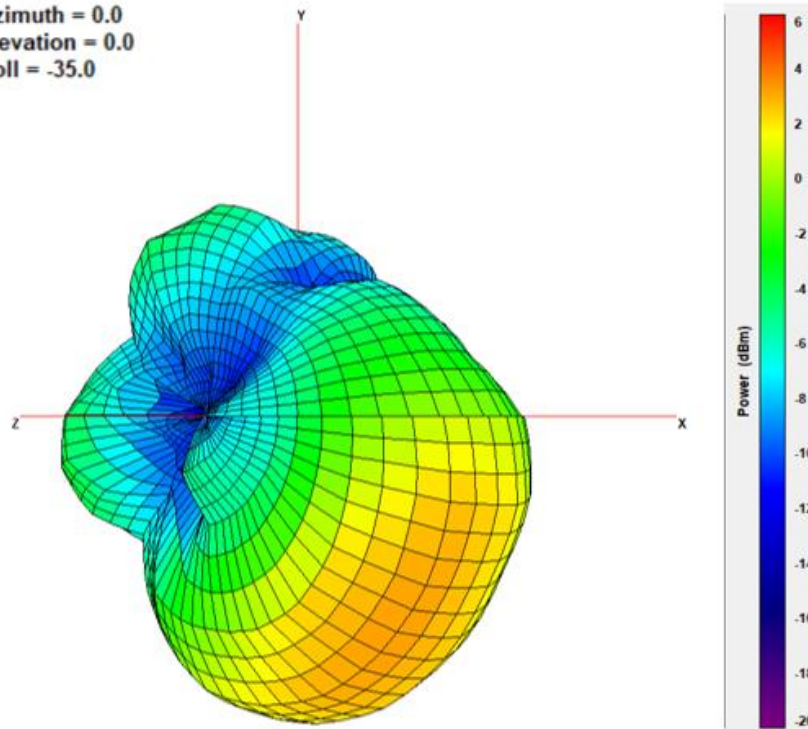

XY Plane

XZ Plane

YZ Plane

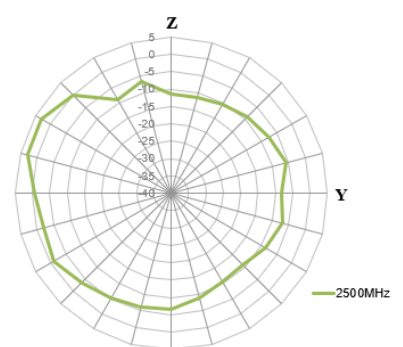
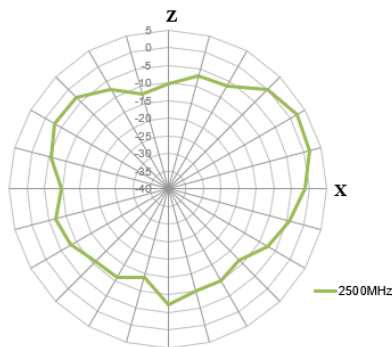
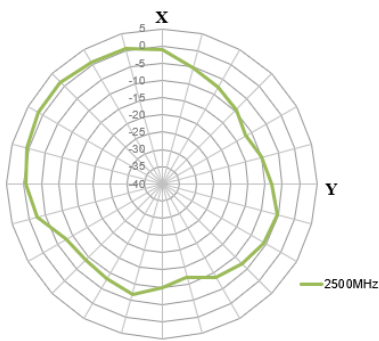

2700MHz

Azimuth = 0.0
Elevation = 0.0
Roll = -35.0

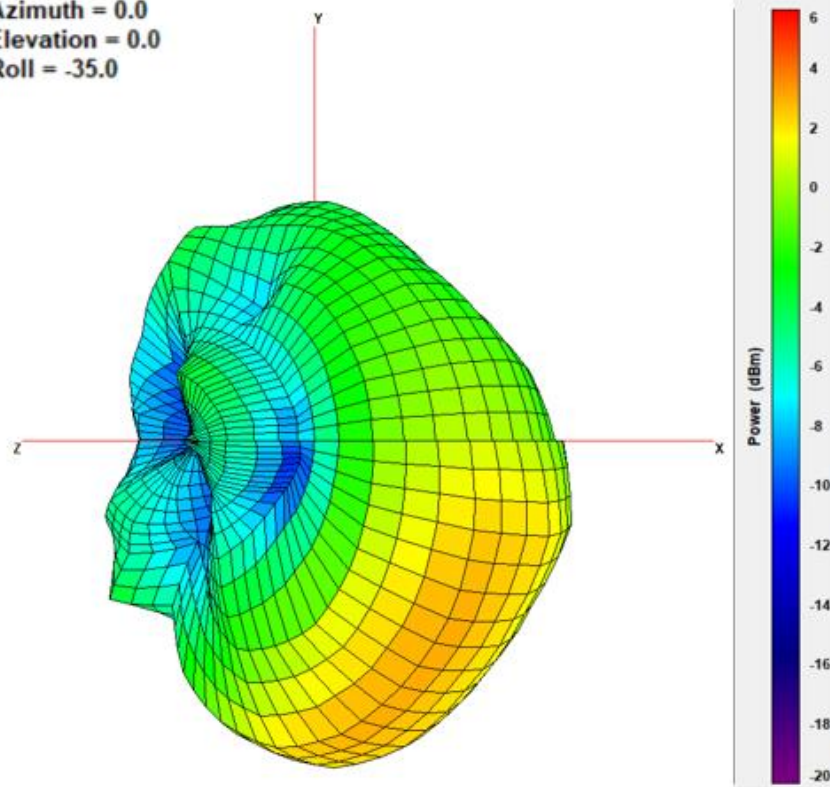

XY Plane

XZ Plane

YZ Plane

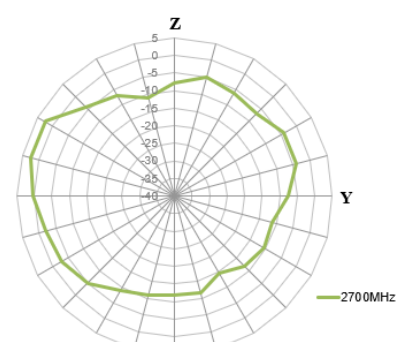
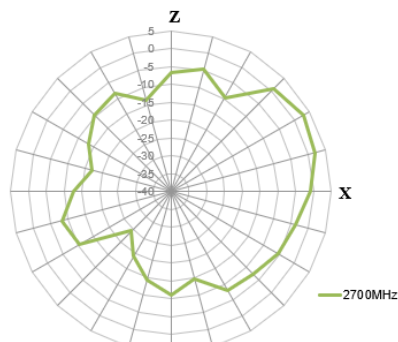
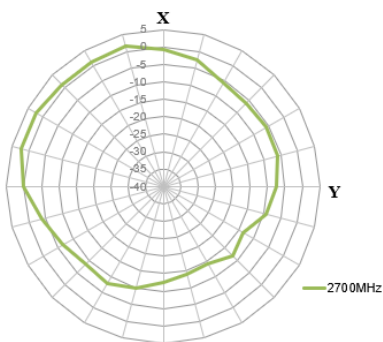

3200MHz

Azimuth = 0.0
Elevation = 0.0
Roll = -35.0

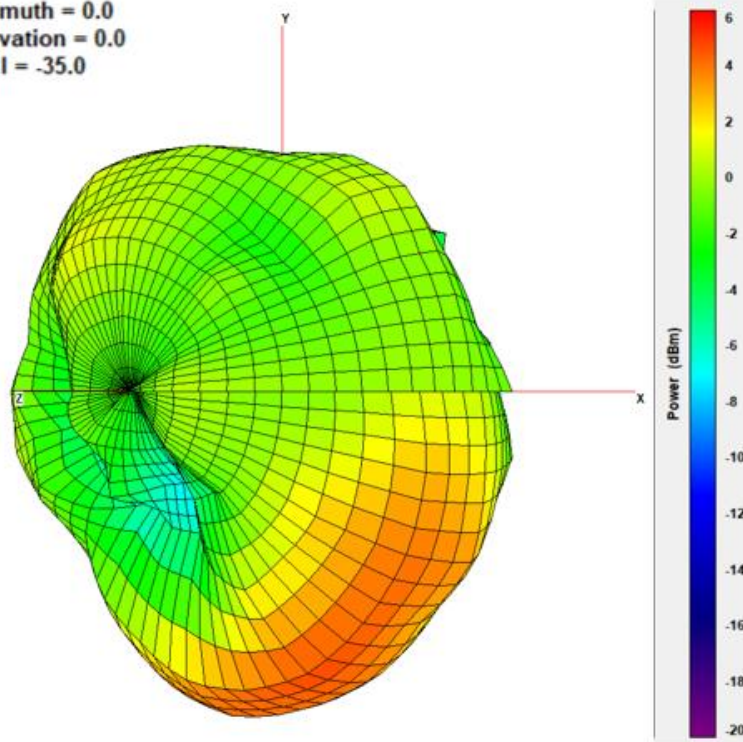

XY Plane

XZ Plane

YZ Plane

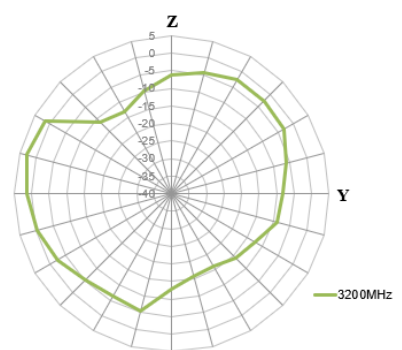
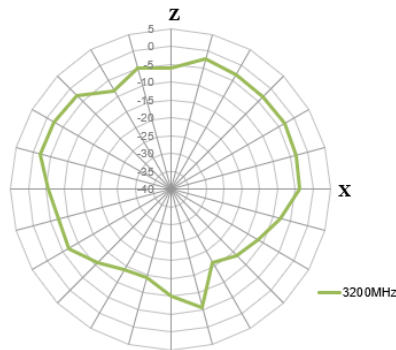
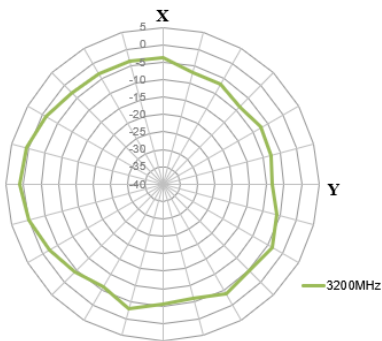

4200MHz

Azimuth = 0.0
Elevation = 0.0
Roll = -35.0

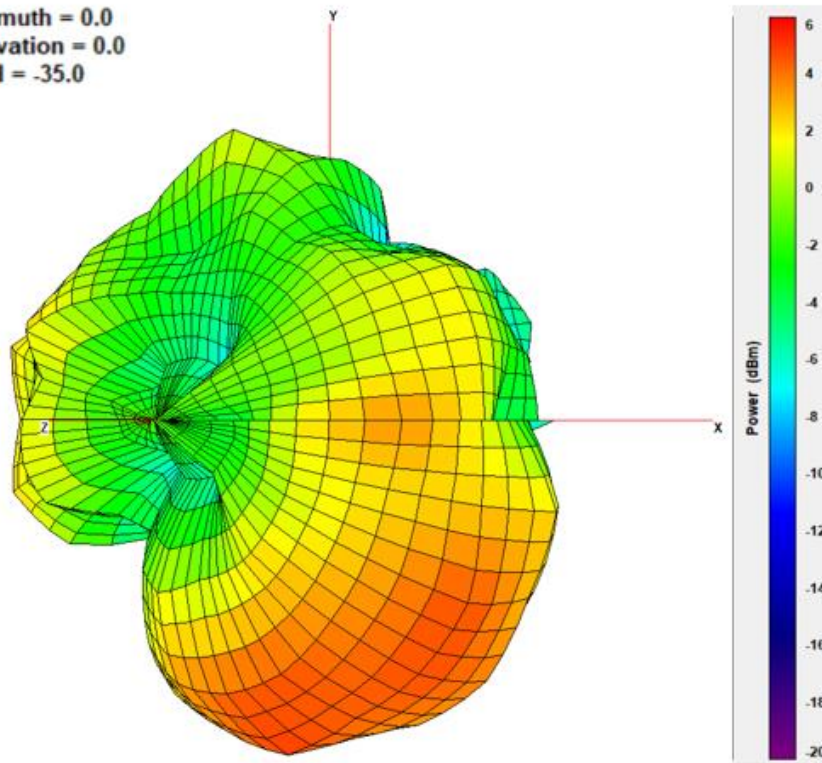

XY Plane

XZ Plane

YZ Plane

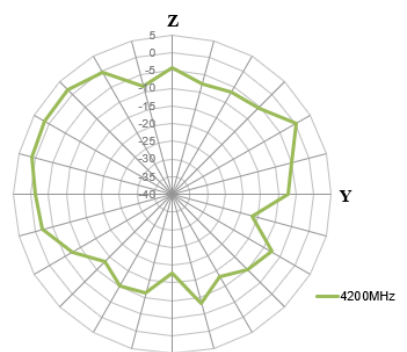
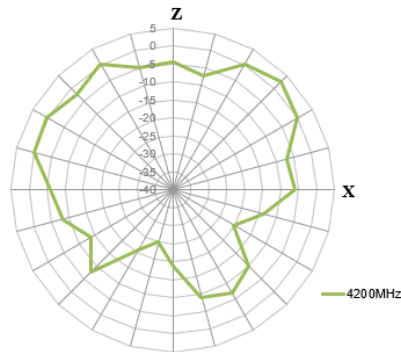
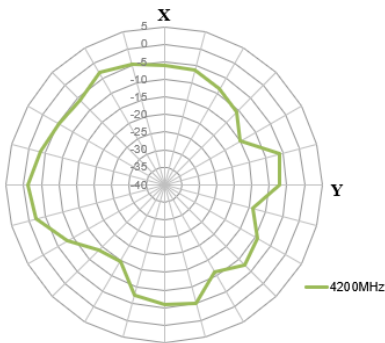

5150MHz

Azimuth = 0.0
Elevation = 0.0
Roll = -35.0

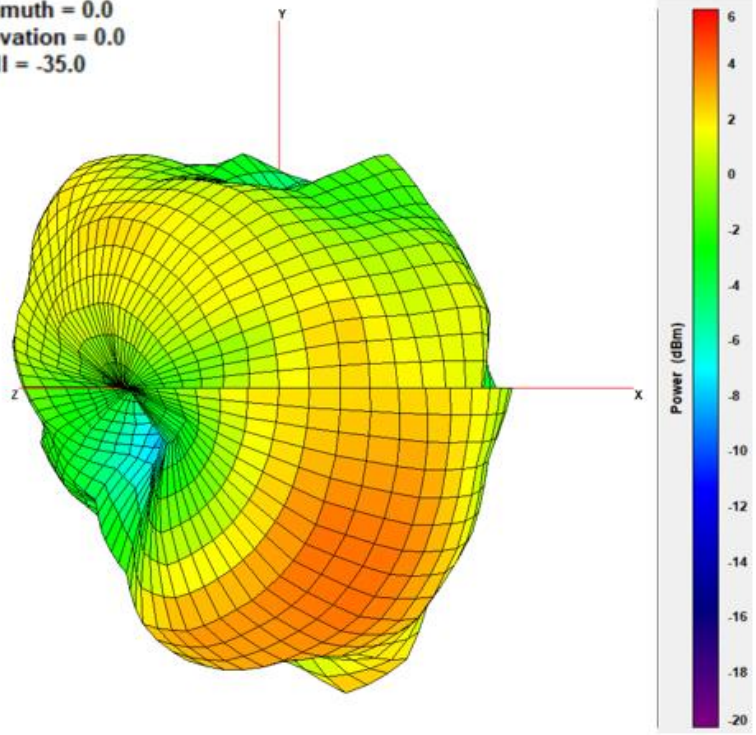

XY Plane

XZ Plane

YZ Plane

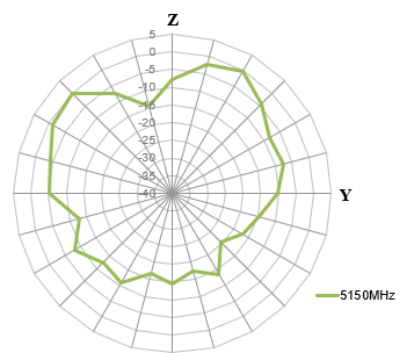
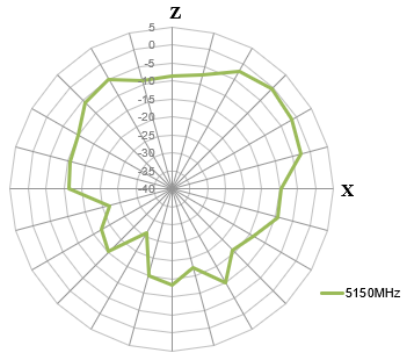
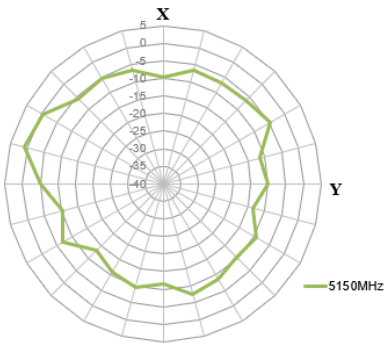

5550MHz

Azimuth = 0.0
 Elevation = 0.0
 Roll = -35.0

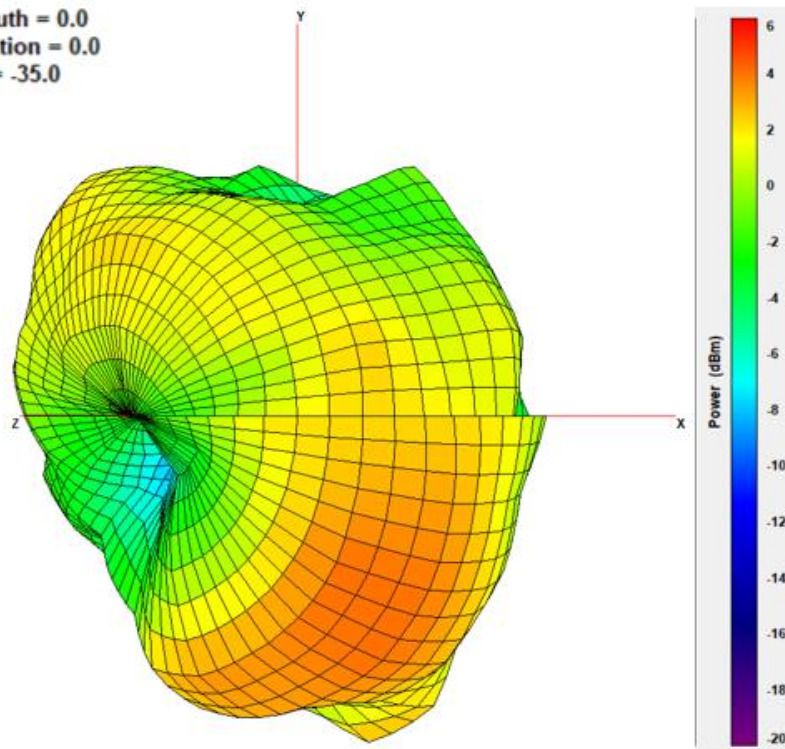

XY Plane

XZ Plane

YZ Plane

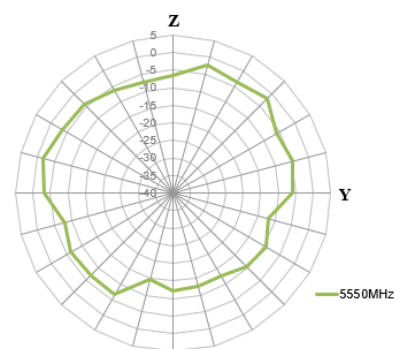
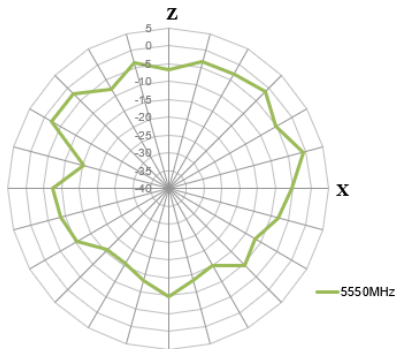
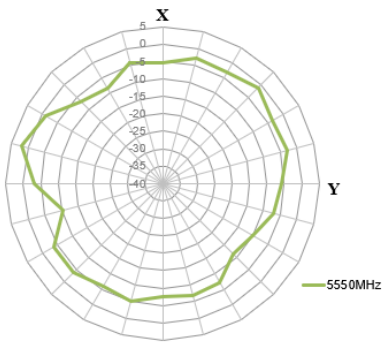

4.5 Wi-Fi1 – 2450MHz 3D and 2D Radiation Patterns

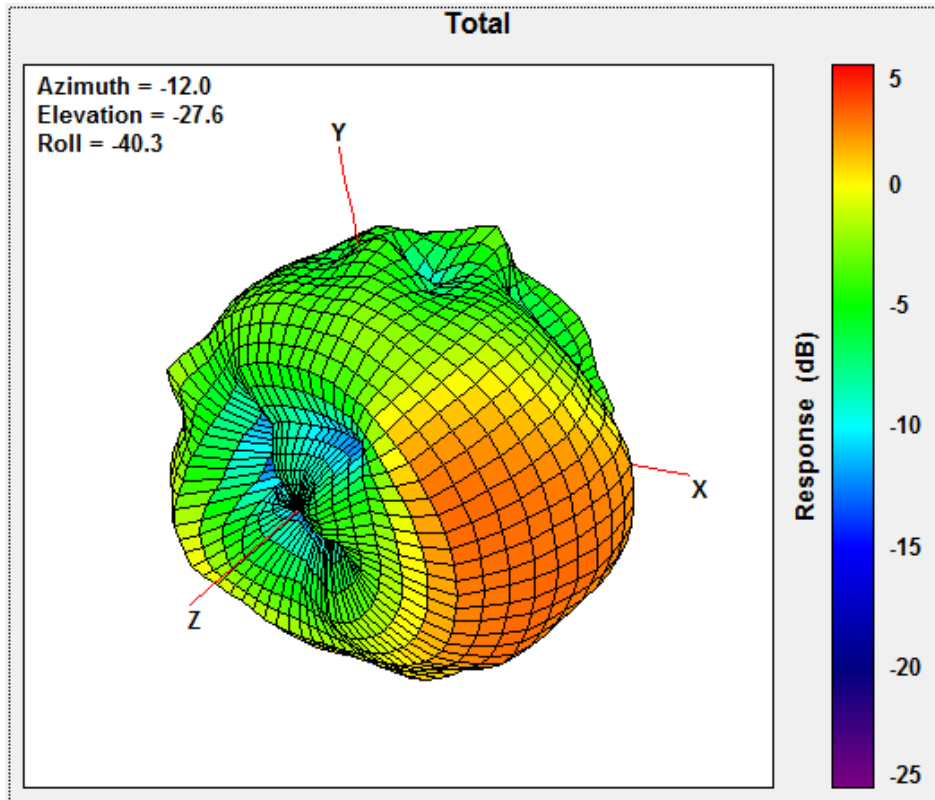

XY Plane

XZ Plane

YZ Plane

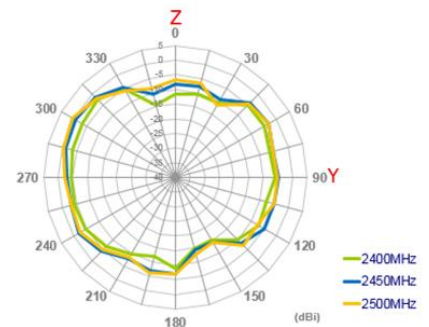
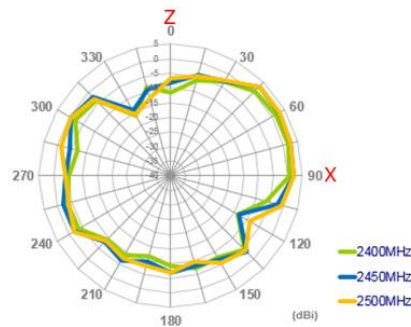
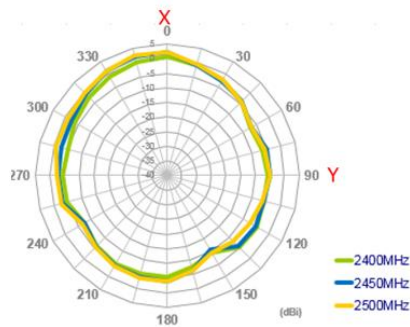

5500MHz

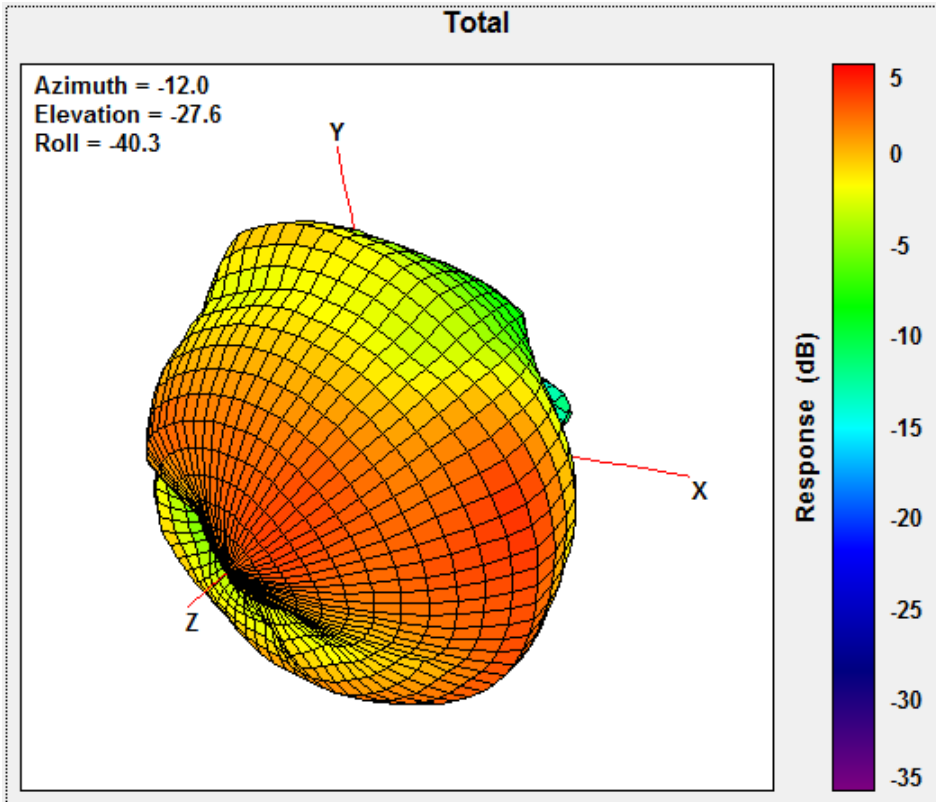

XY Plane

XZ Plane

YZ Plane

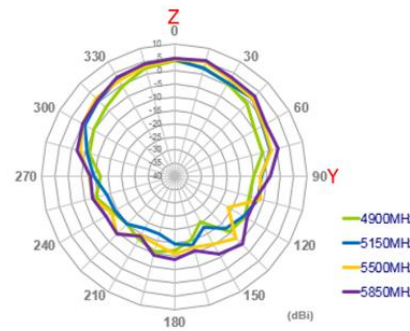
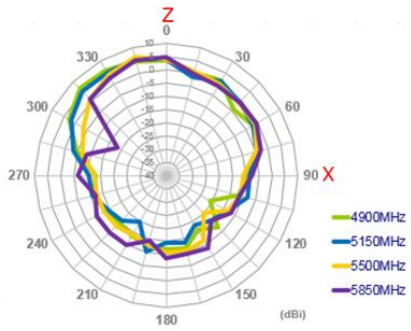
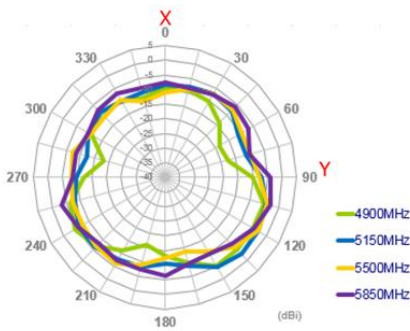

4.6 Wi-Fi2 – 2450MHz 3D and 2D Radiation Patterns

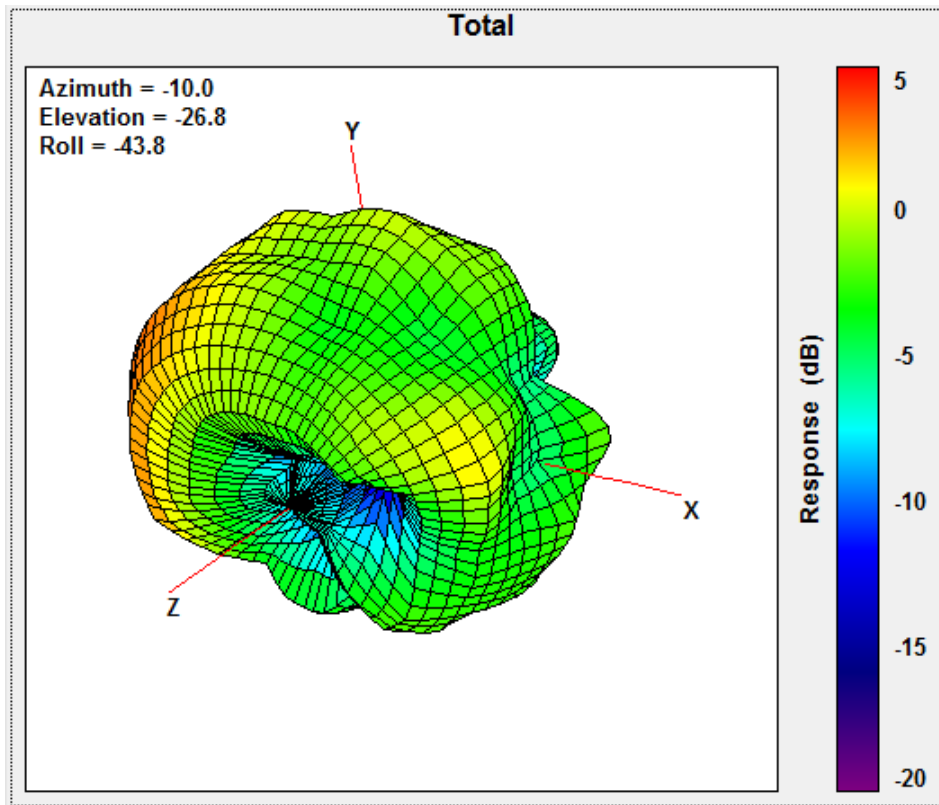

XY Plane

XZ Plane

YZ Plane

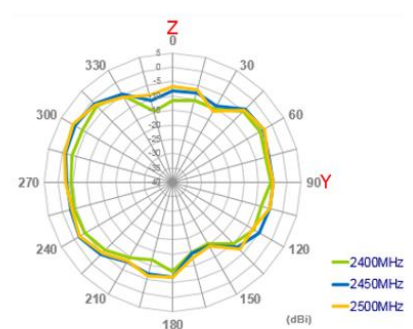
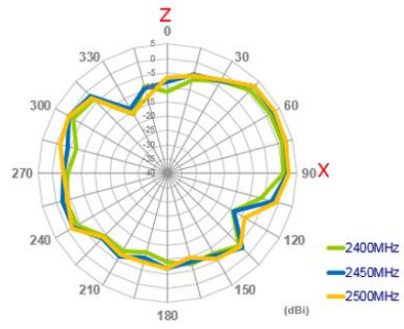
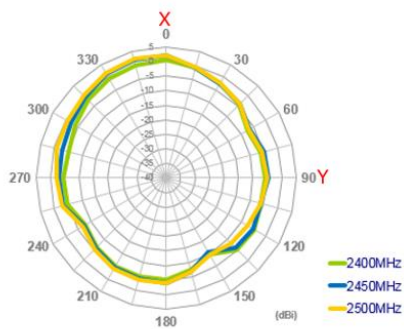

5500MHz

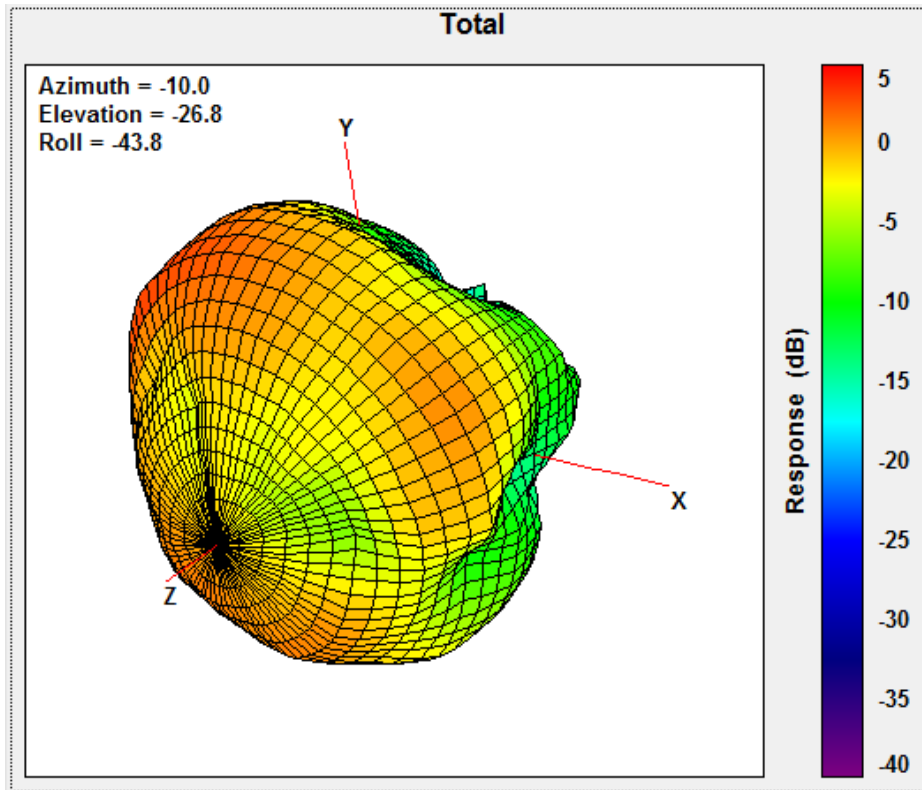

XY Plane

XZ Plane

YZ Plane

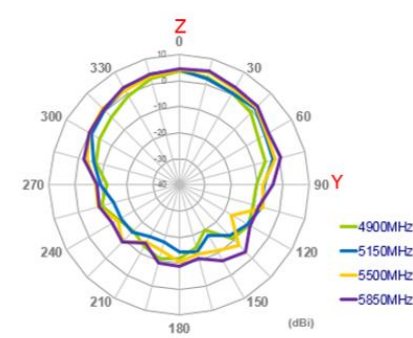
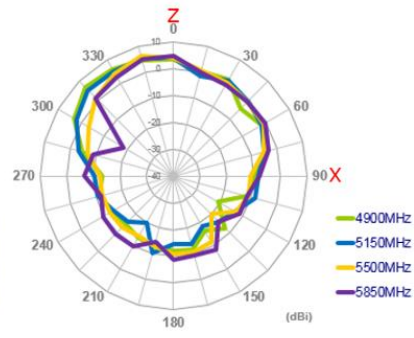
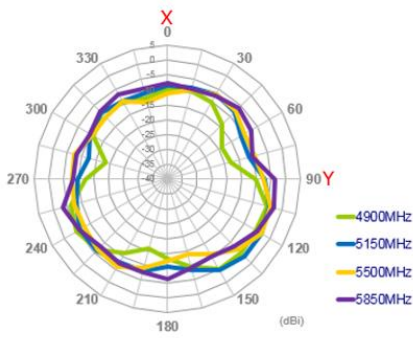

5. Mechanical Drawing (Units: mm)

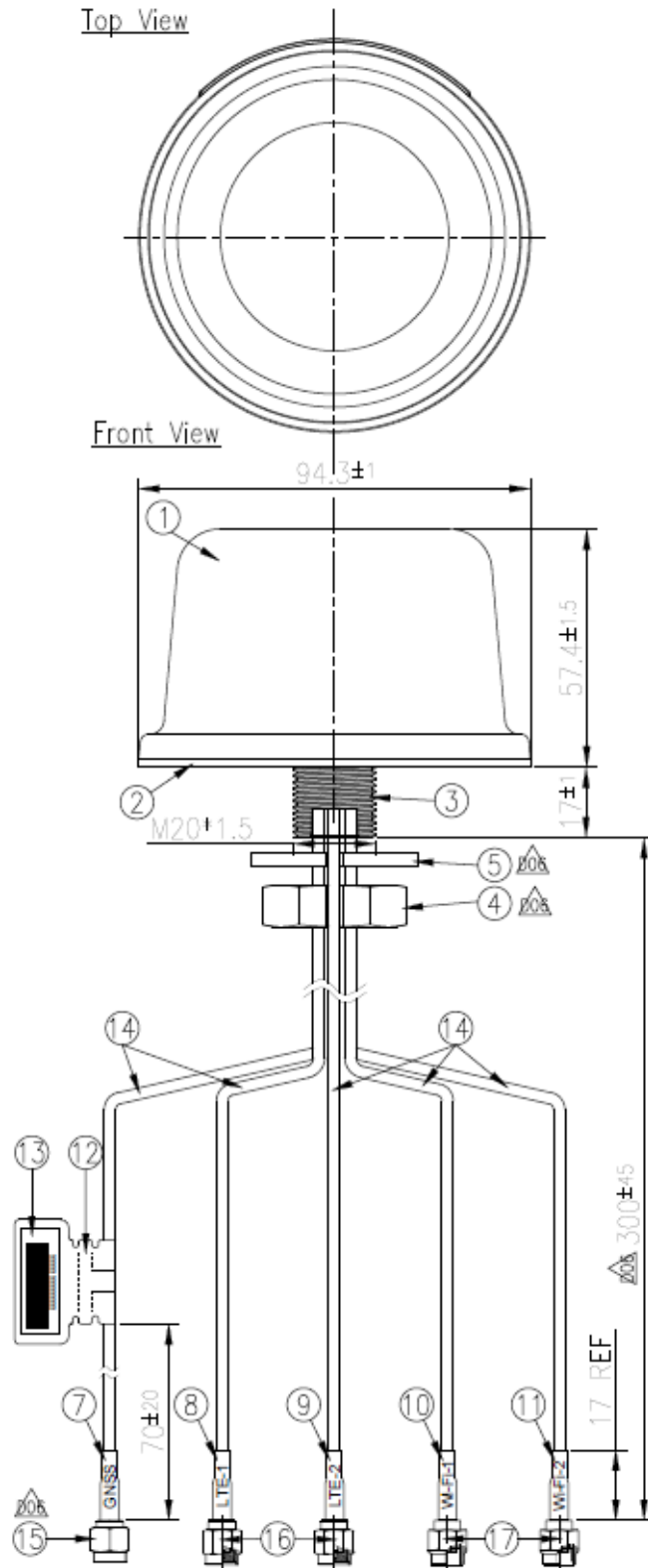

Name	P/N	Material	Finish	QTY
1 Mini ST Short Case	000114K000092A	ASA	Black	1
2 Adhesive Foam Mini ST(Black Foam)	001015C020000A	3M9448+CR 4305	White Liner	1
3 Mini ST Base	000314K000092A	Zinc Alloy	Ni Plated	1
4 Nut_M20x1.5Px9.5H Cut	000413E030061A	Steel Carbon	Zn-Ni Plated	1
5 Washer_Cut	000413E040061A	Steel Carbon	Zn-Ni Plated	1
6 Cable Rubber_ST_6IN1	000713K000064A	Silicone Rubber	Black	1
7 Heat Shrink Tube (GNSS)	001316C000000A	PE	Blue Tube/White Test	1
8 Heat Shrink Tube (LTE-1)	001316C040000A	PE	Red Tube/White Test	1
9 Heat Shrink Tube (LTE-2)	001316C050000A	PE	Red Tube/White Test	1
10 Heat Shrink Tube (Wi-Fi-1)	001316C060000A	PE	Yellow Tube/Black Test	1
11 Heat Shrink Tube (Wi-Fi-2)	001316C070000A	PE	Yellow Tube/Black Test	1
12 Empty Label	001015G000000A	PET	White	1
13 Barcode Label	001015G010000A	PET	White	1
14 RG174 Cable Type	301315C000000A	PVC	Black	5
15 SMA(M)ST	200216D000098A	Brass	Au Plated	1
16 SMA(M)ST	200212G000013A	Brass	Au Plated	2
17 RP-SMA(M)ST	200213D000013A	Brass	Au Plated	2

6. Installation Guide

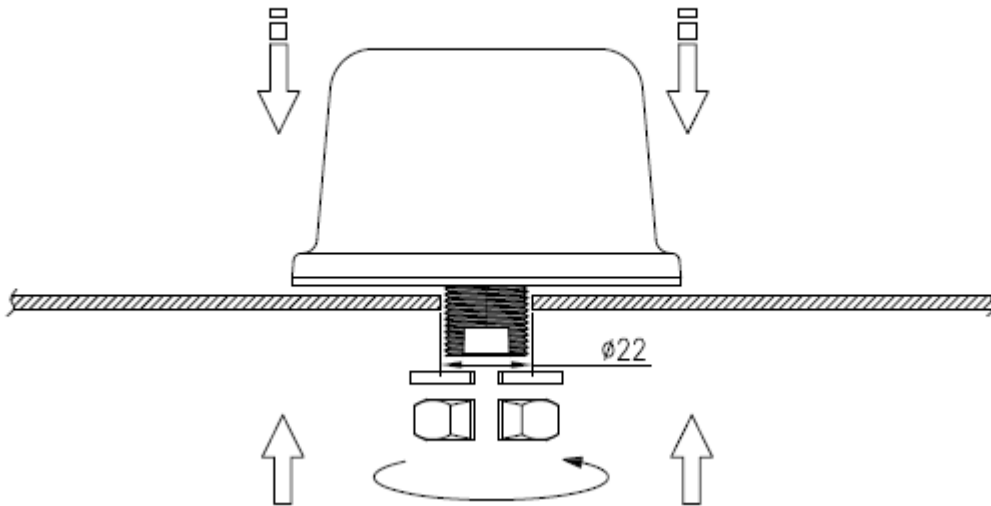

Recommended torque for mounting: 5-7Nm

(Torque value obtained with antenna mounted on 1mm thick SUS-316 bracket)

7. Packaging

Packaging Specifications

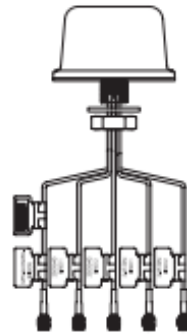

20 pcs MA850.A.LBICG.001 per layer
2 Layers per carton

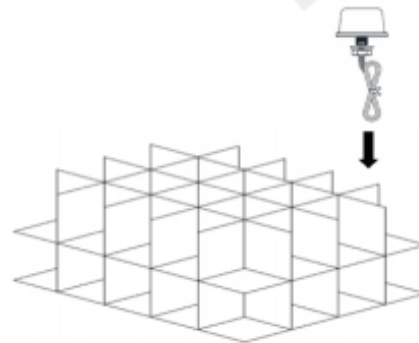

40 pcs MA850.A.LBICG.001 per carton
Carton - 532 x 429 x 200mm
Weight - 14Kg

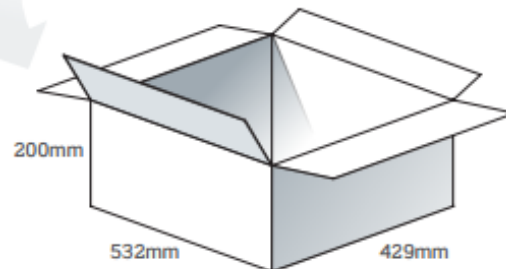

Pallet Dimensions 1200 x 1000 x 1390mm
24 Cartons per Pallet
6 Cartons per layer
4 Layers

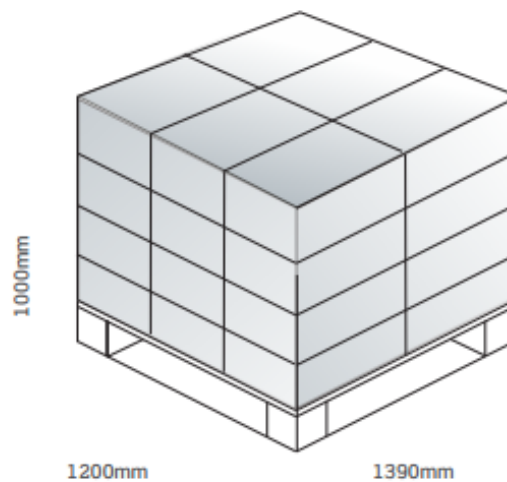

8. Application Note

The MA850 antenna performance with different cable length as shown below.

8.1 LTE 1 - Return Loss

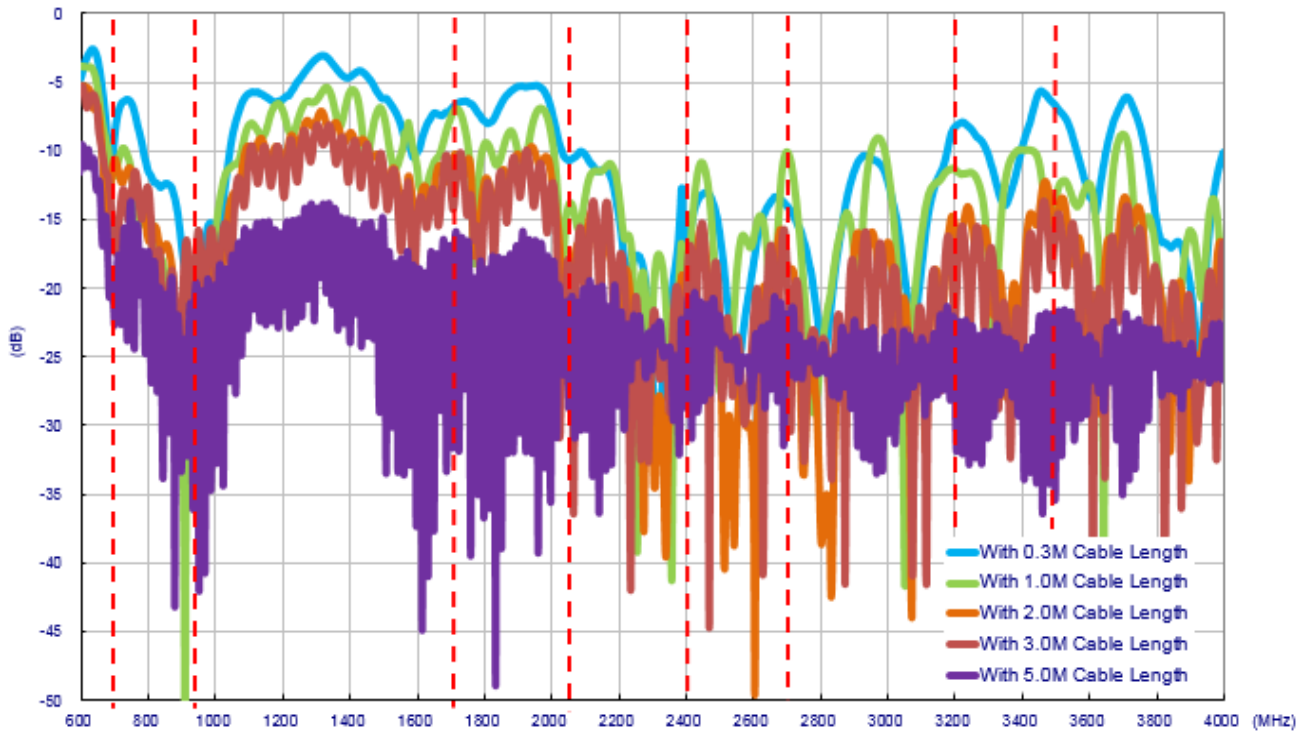

8.2 LTE 2 – Return Loss

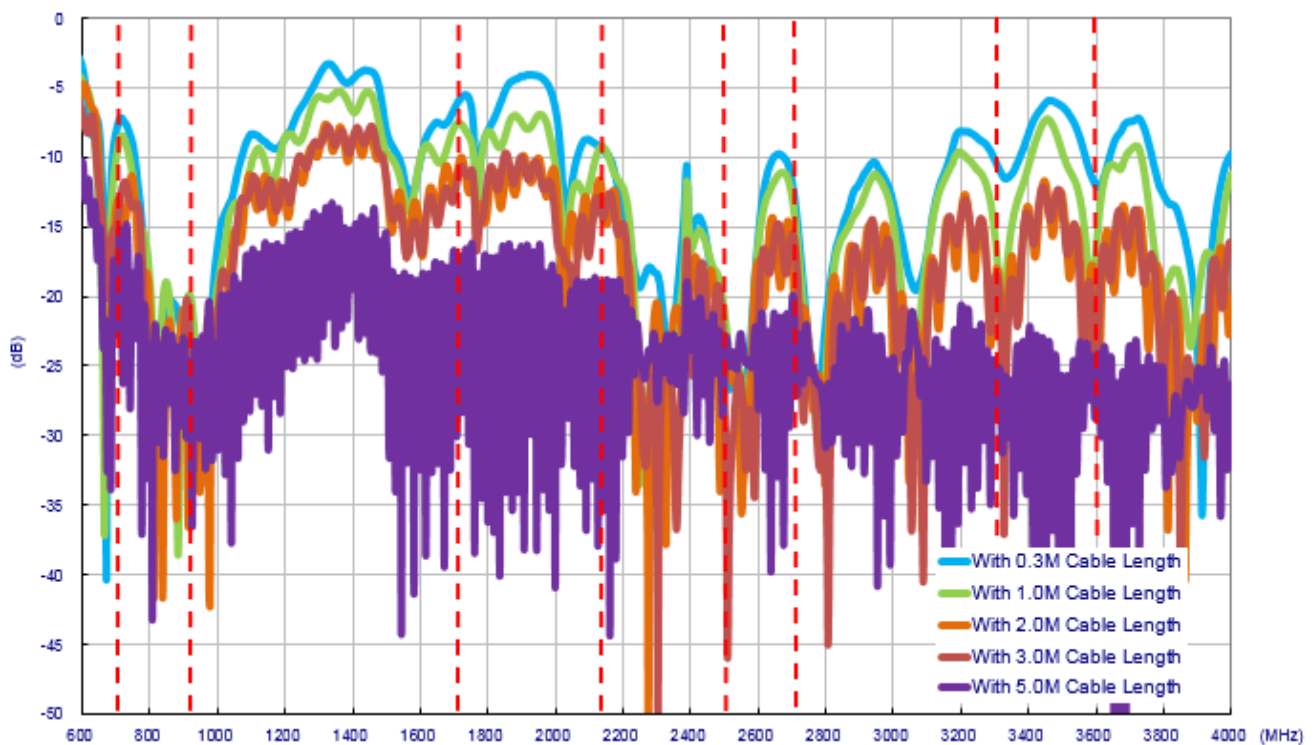

8.3 LTE - Isolation

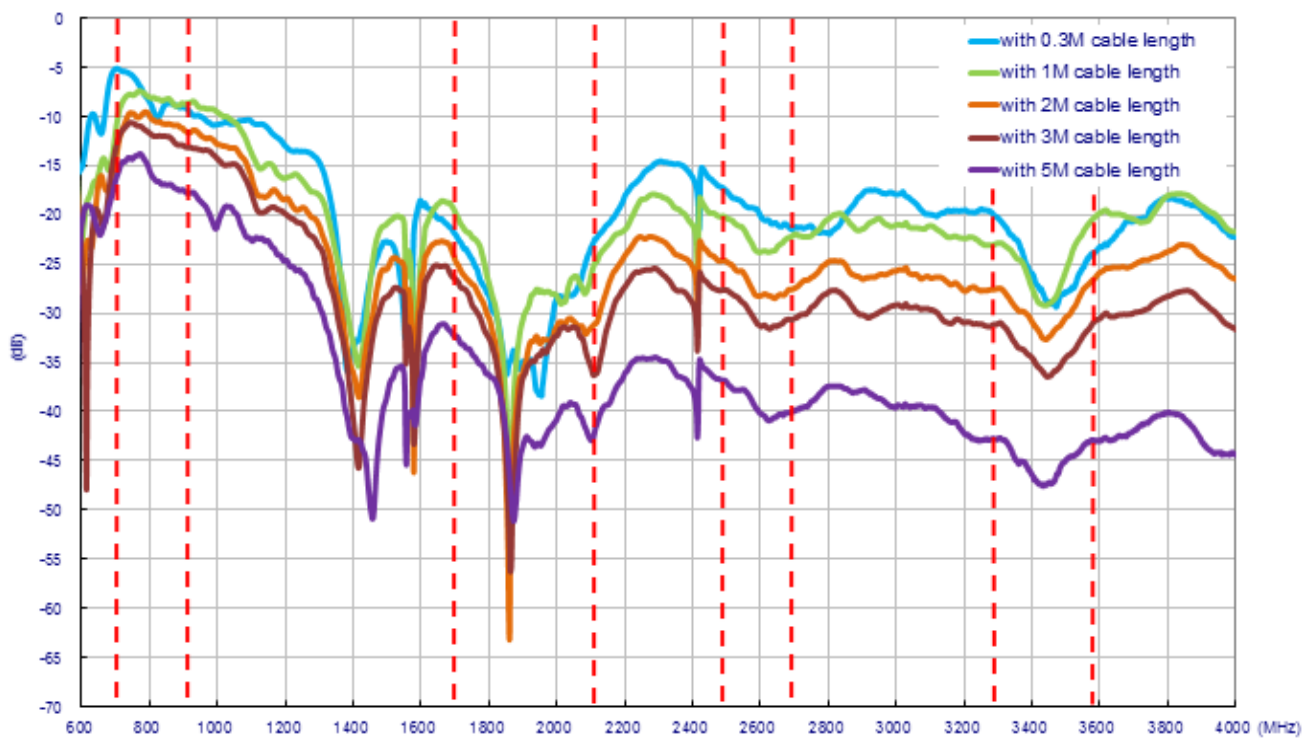

8.4 LTE 1 – Efficiency

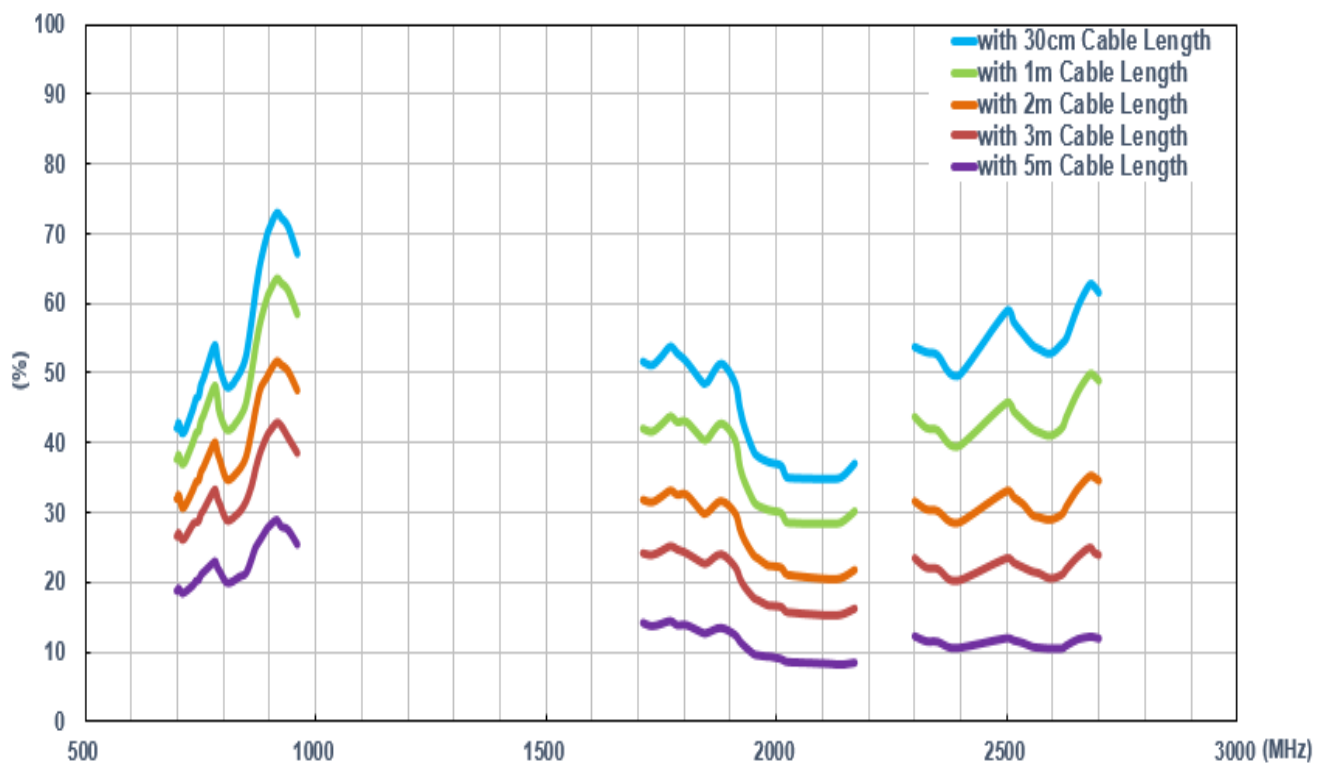

8.5 LTE 2 - Efficiency

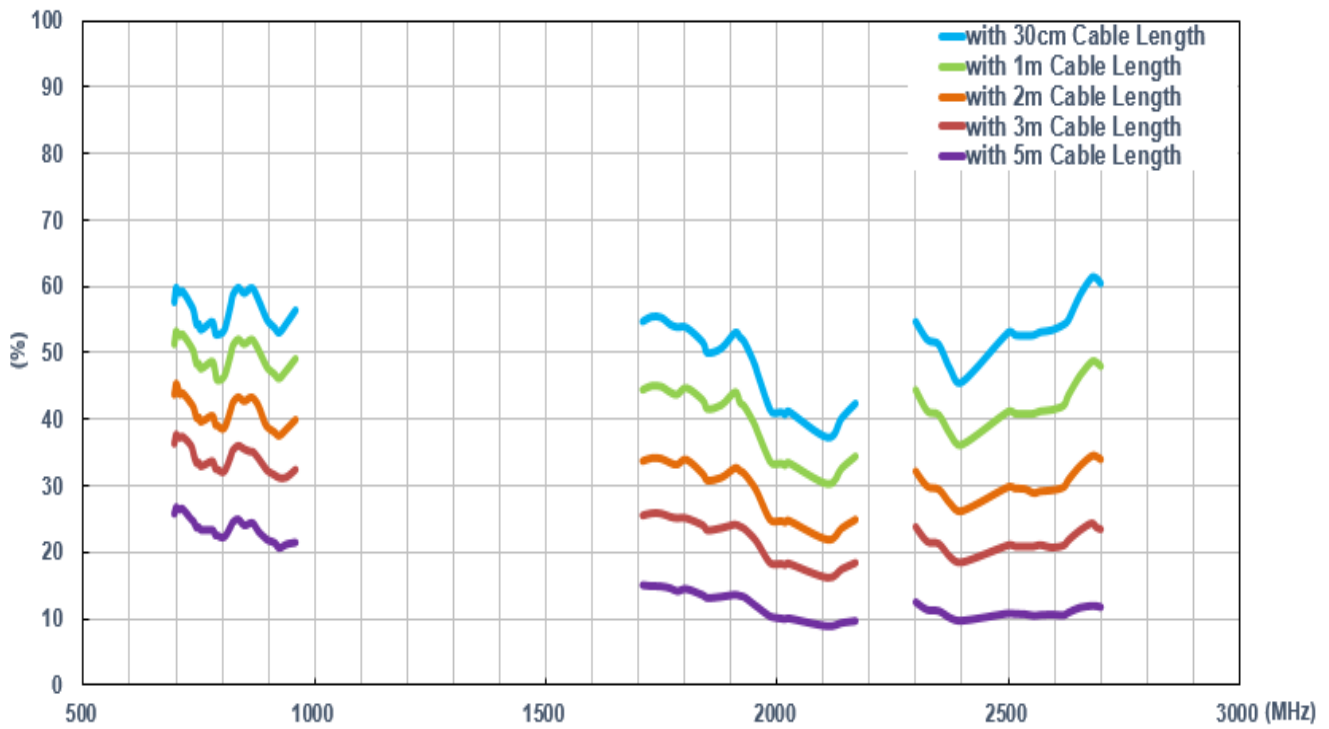

8.6 LTE 1 – Average Gain

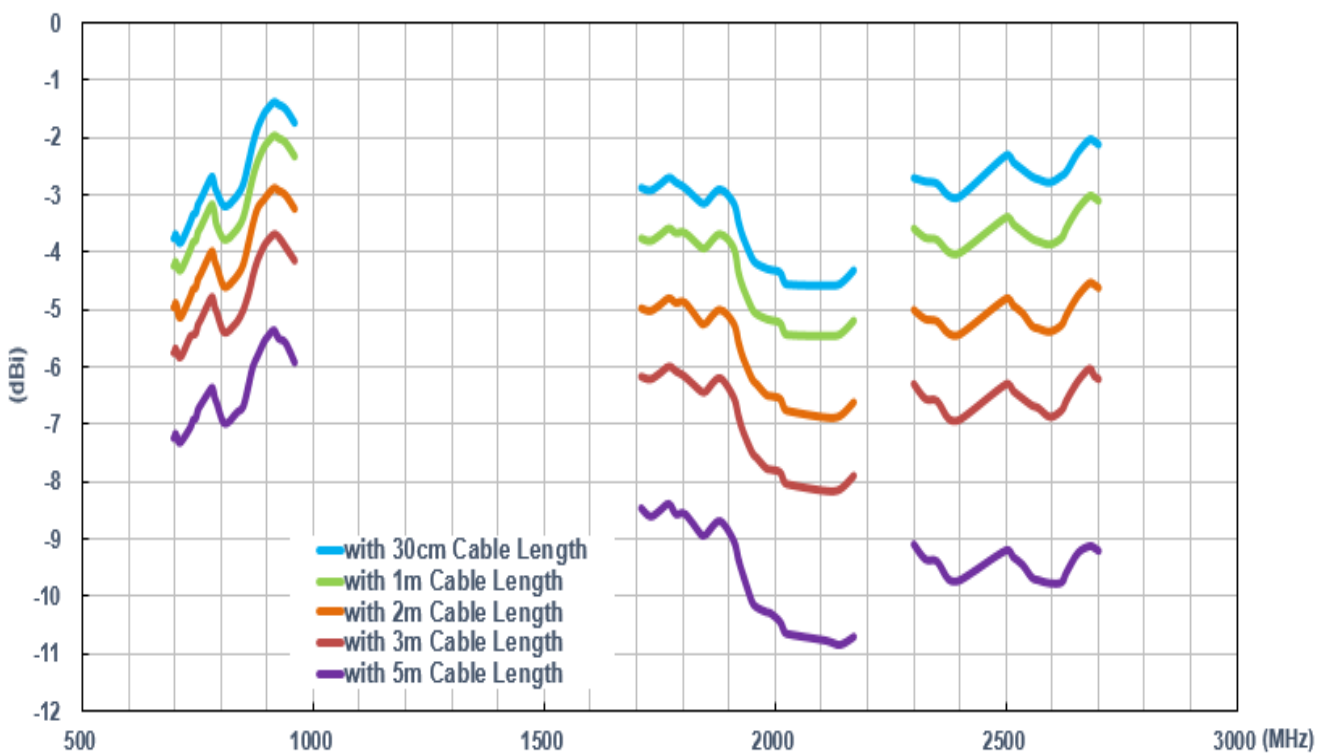

8.7 LTE 2 – Average Gain

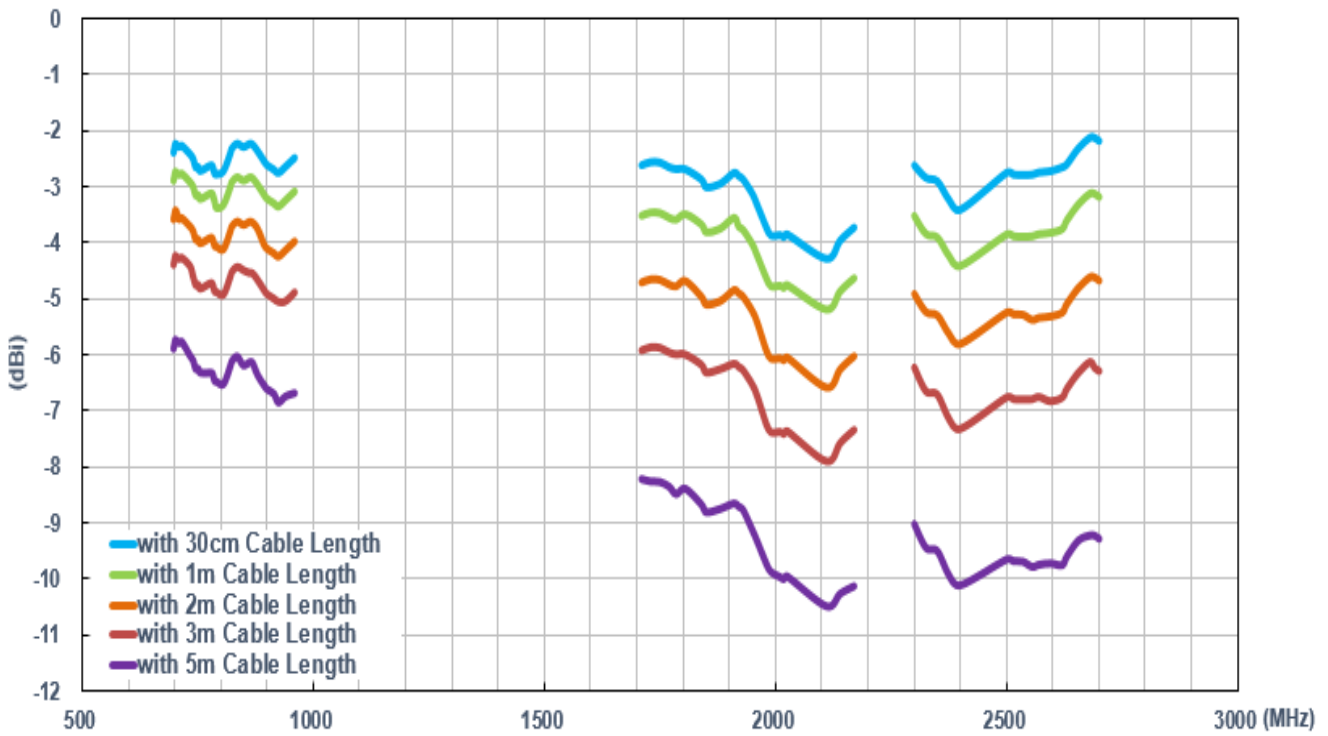

8.8 LTE 1 – Peak Gain

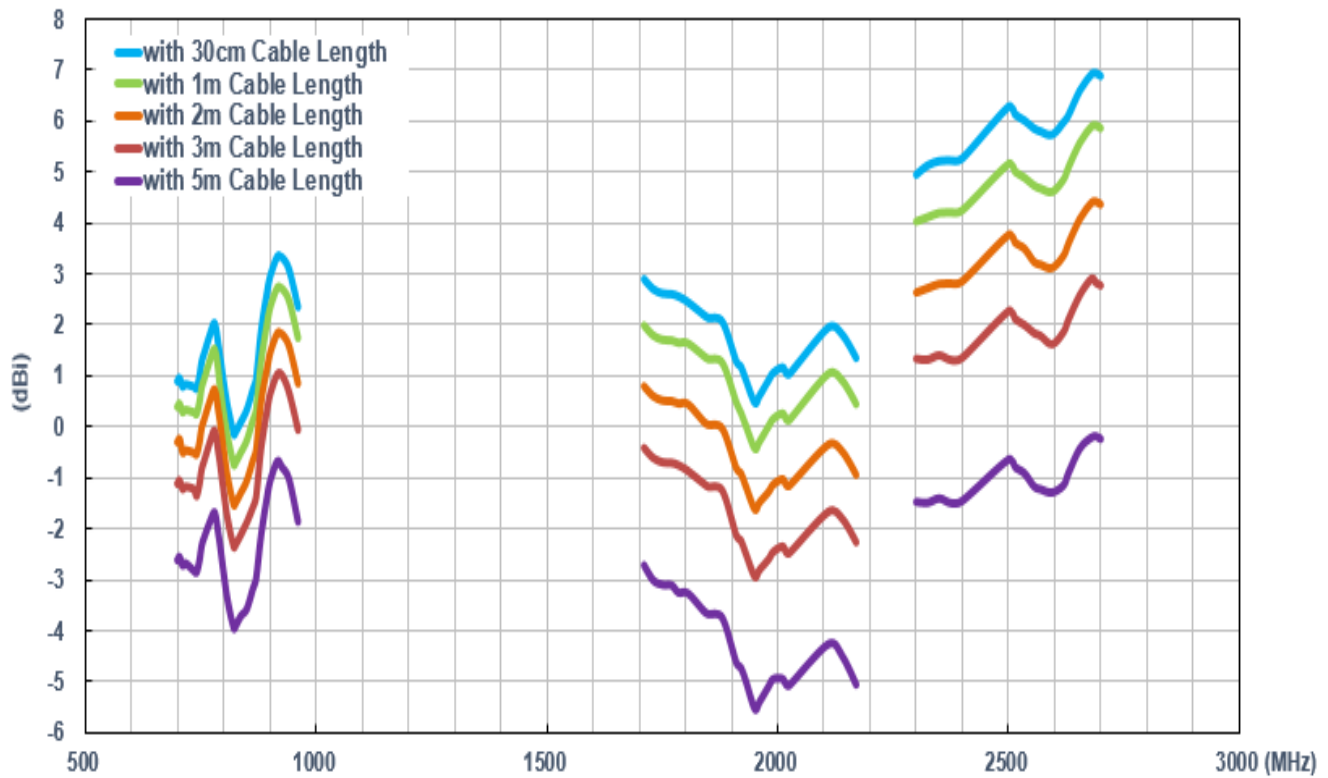

8.9 LTE 2 – Peak Gain

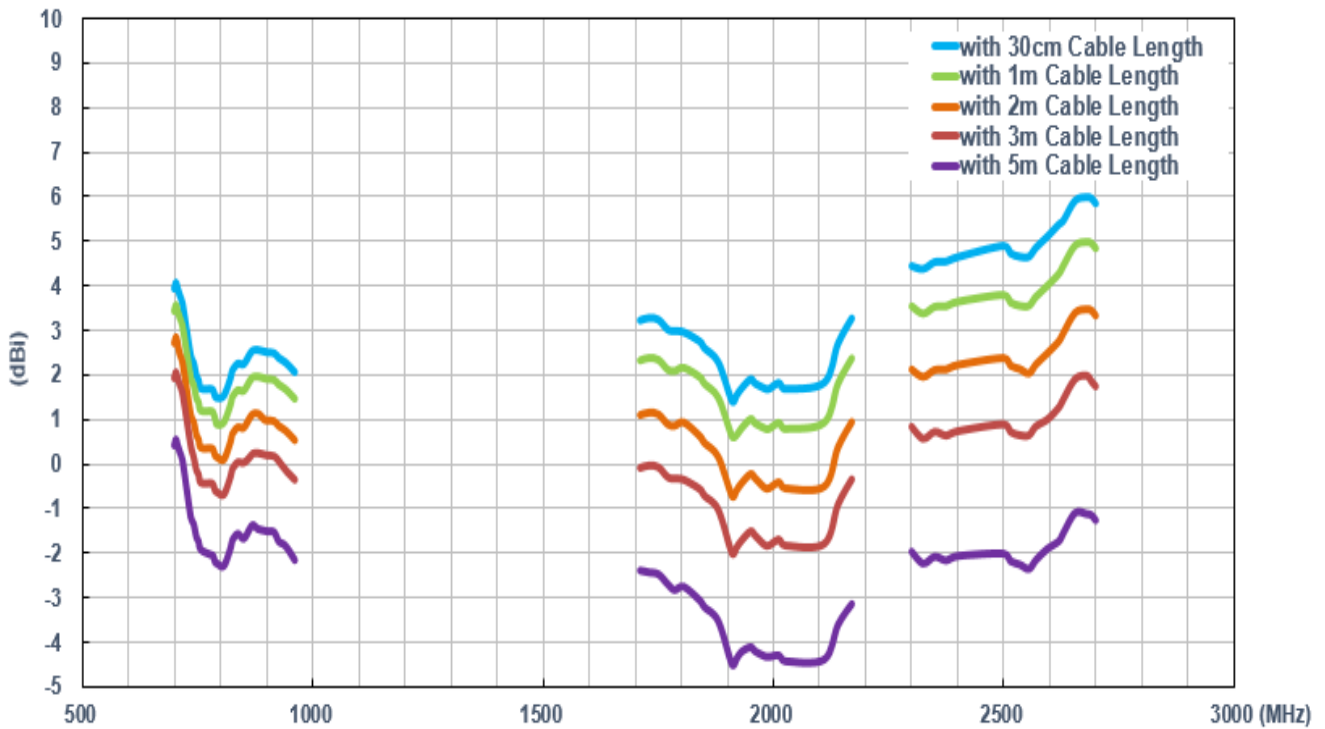

8.10 Wi-Fi 1 – Return Loss

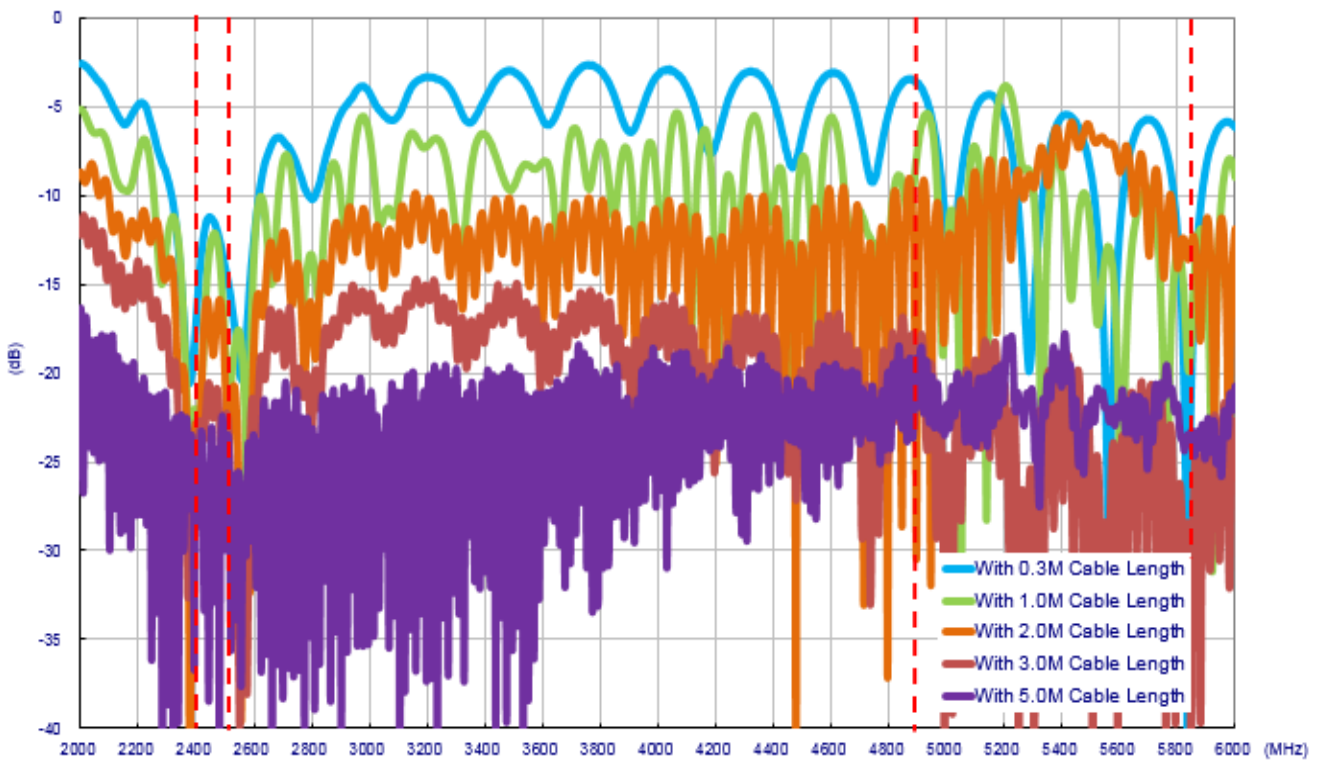

8.11 Wi-Fi 2 – Return Loss

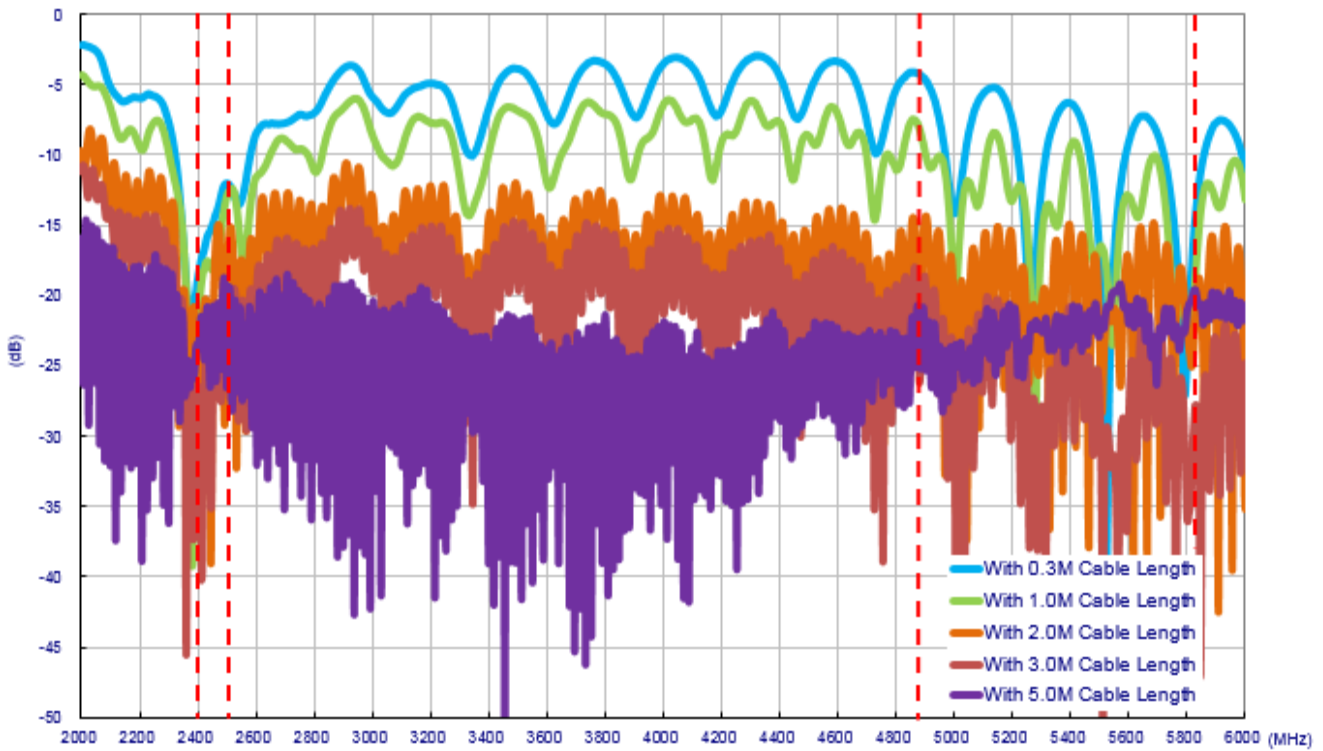

8.12 Wi-Fi - Isolation

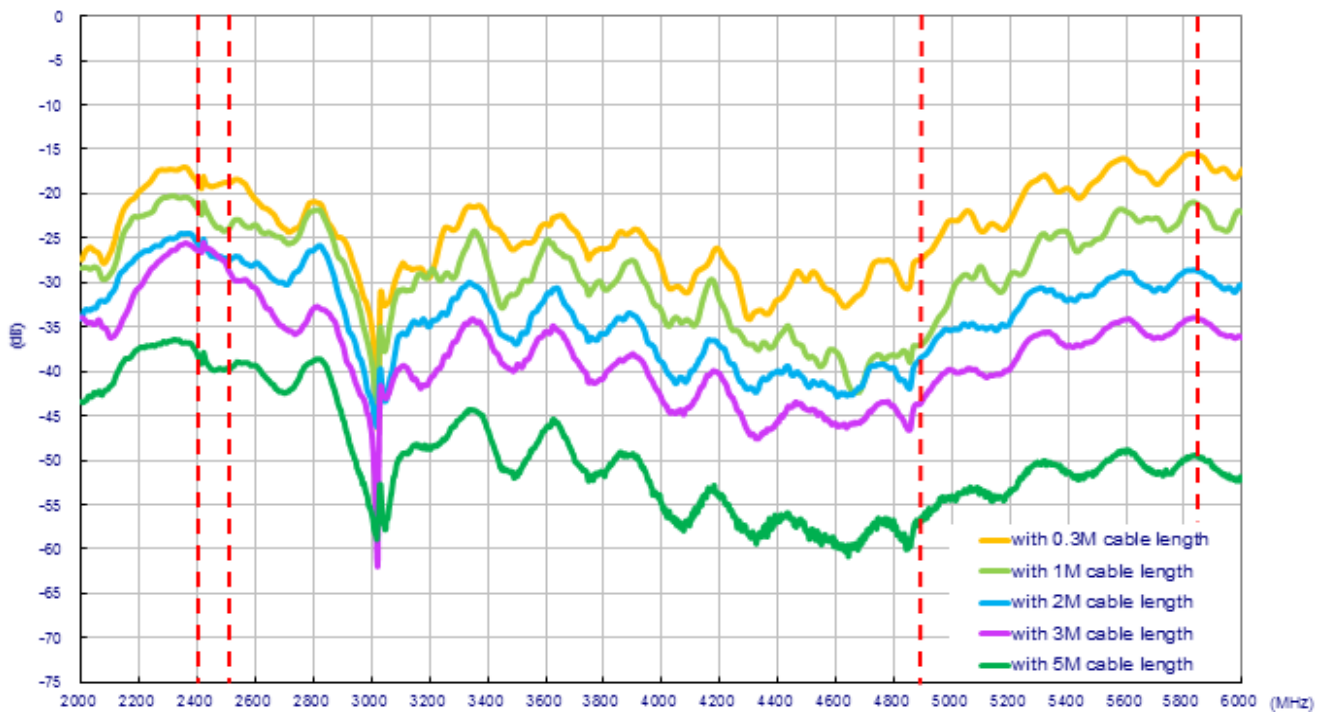

8.13 Wi-Fi 1 – Efficiency

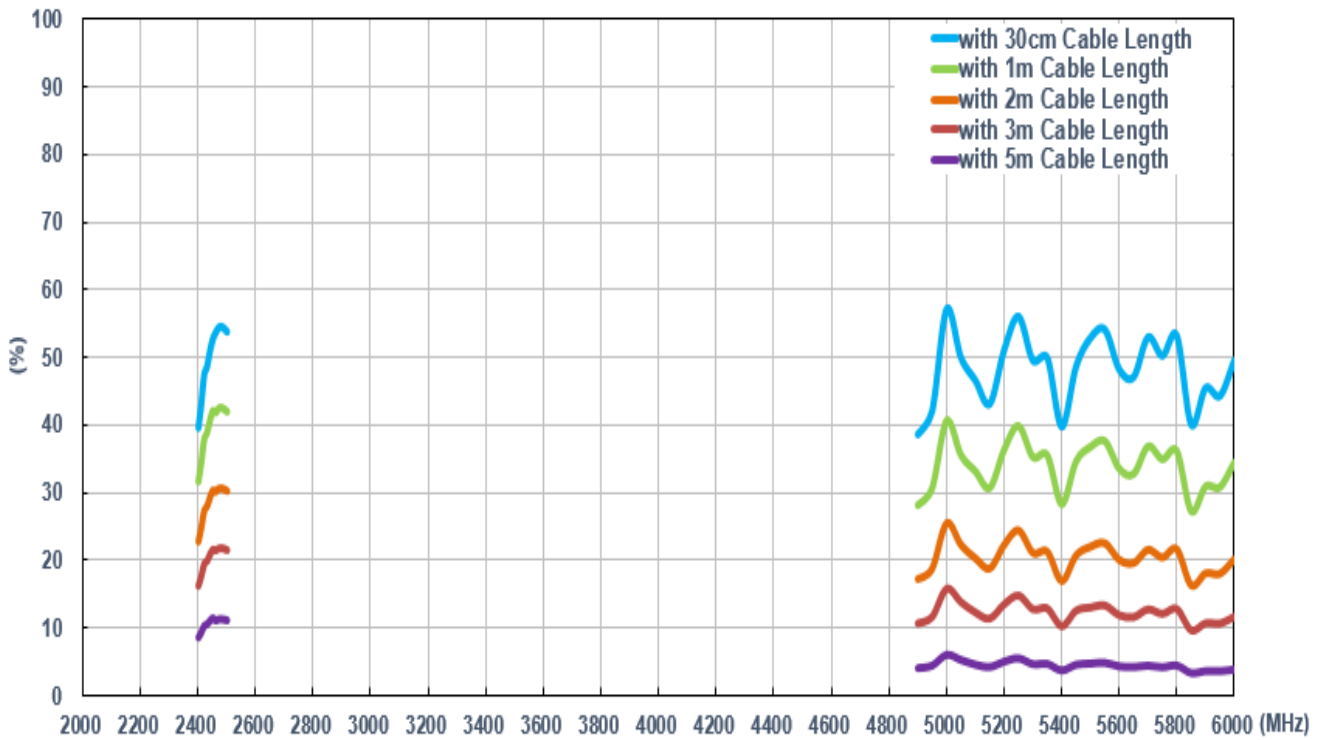

8.14 Wi-Fi 2 – Efficiency

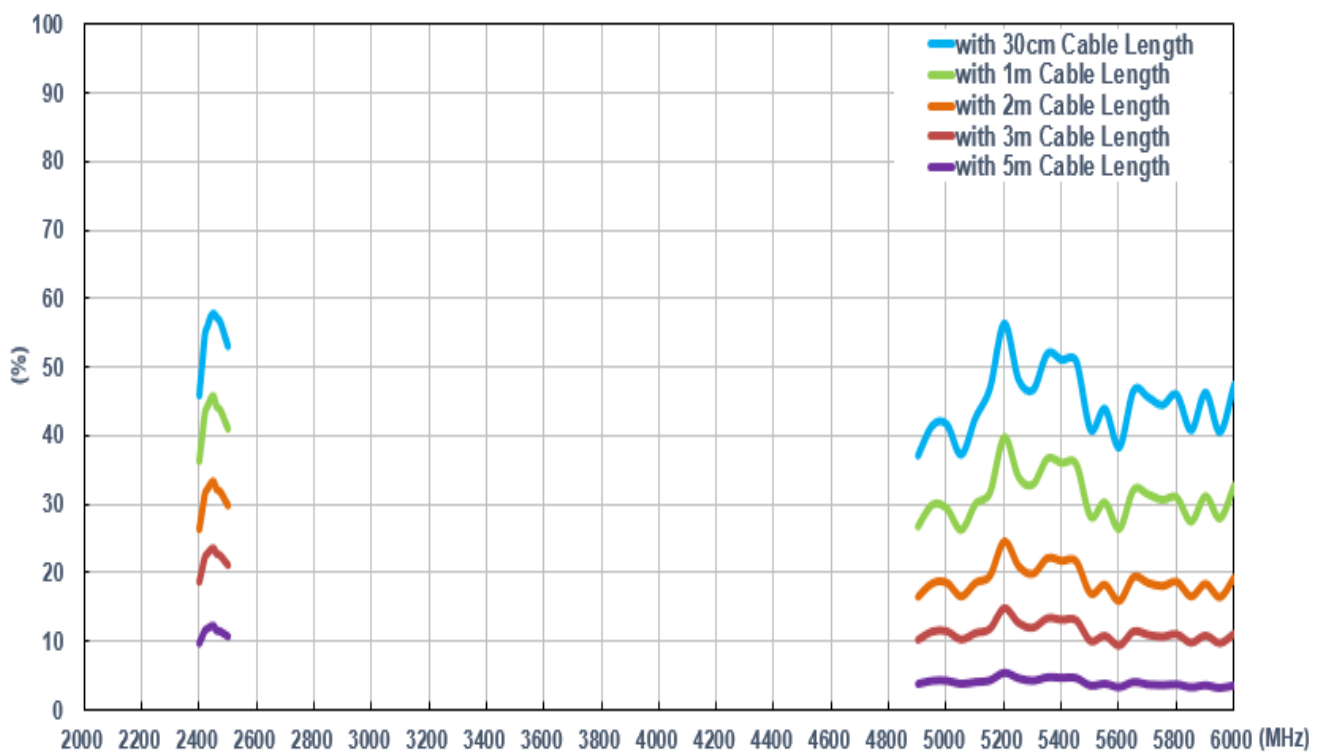

8.15 Wi-Fi 1 – Average Gain

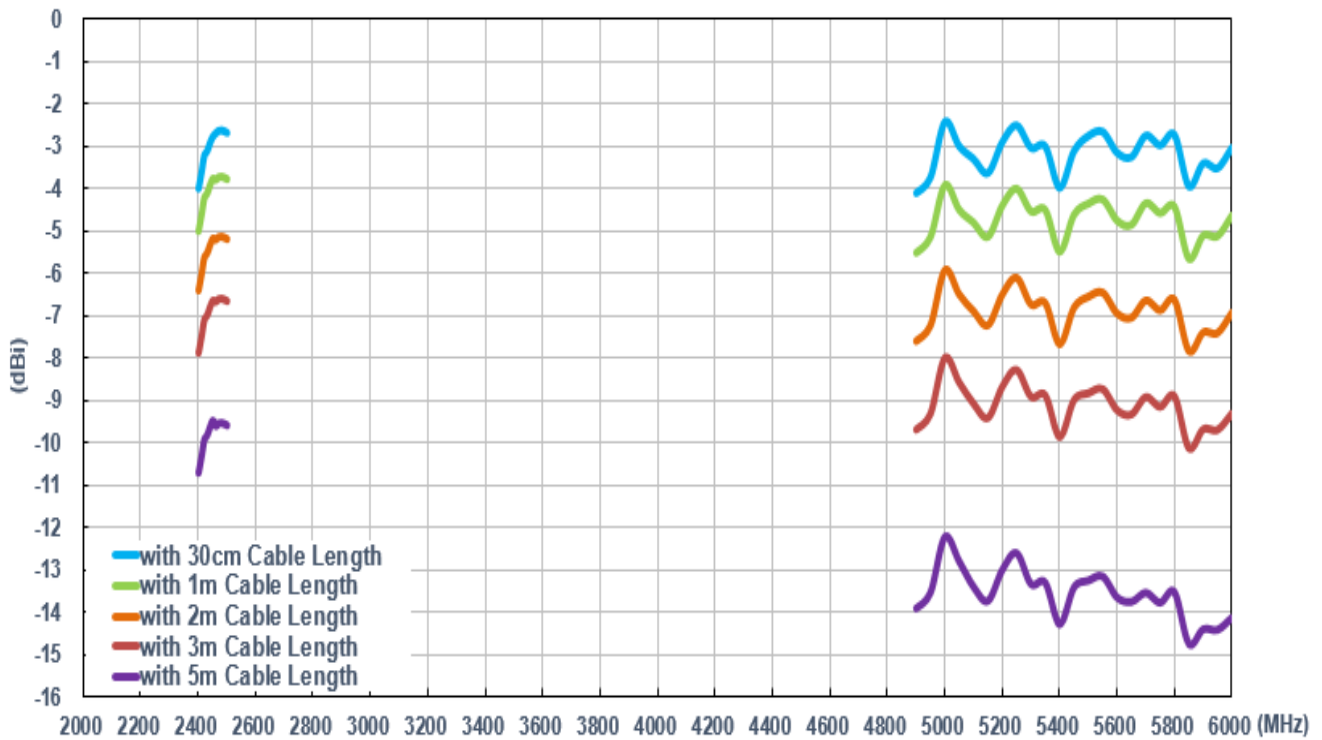

8.16 Wi-Fi 2 – Average Gain

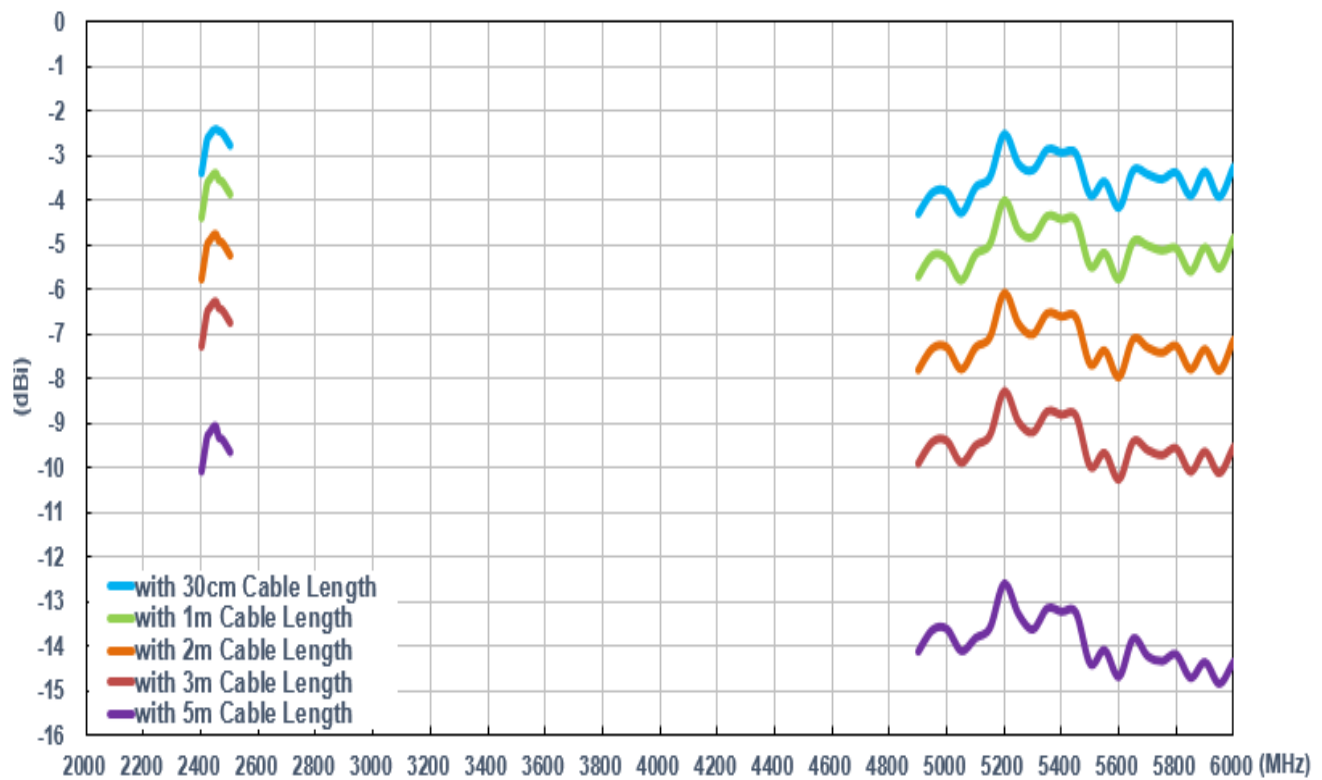

8.17 Wi-Fi 1 – Peak Gain

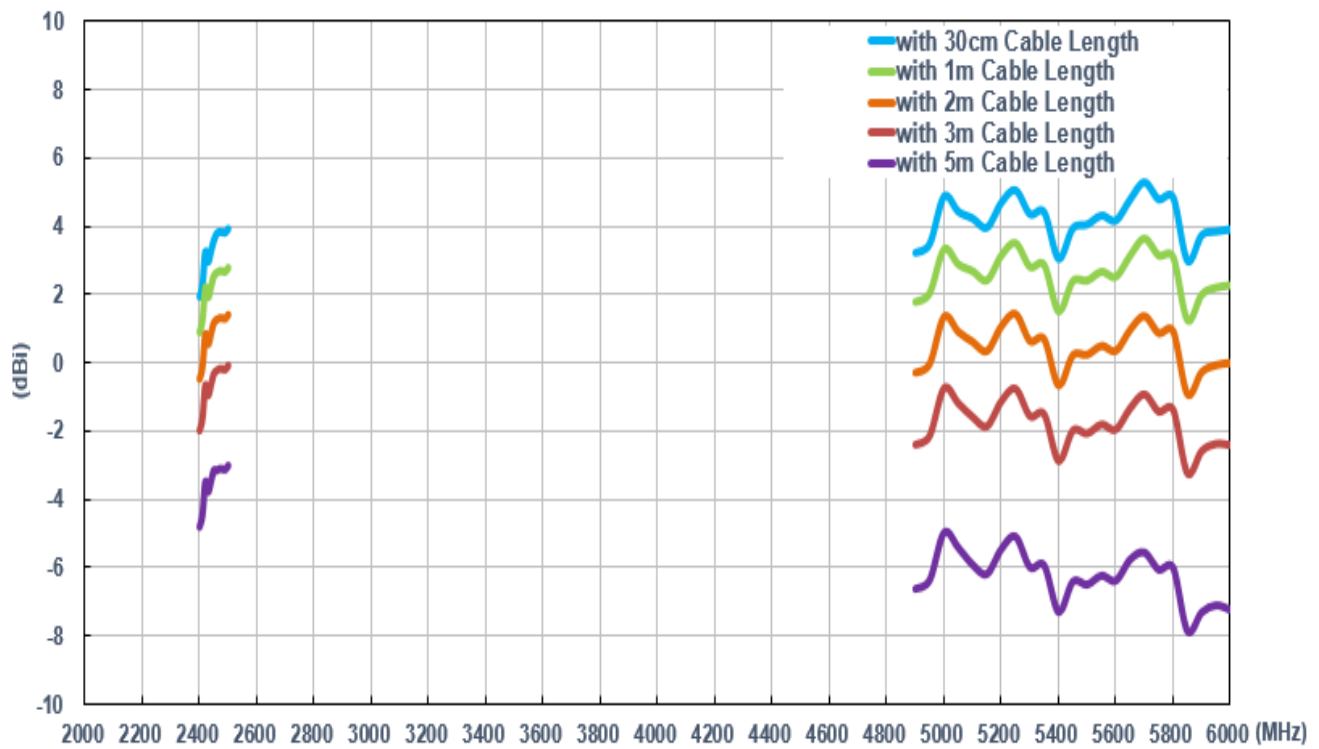

8.18 Wi-Fi 2 – Peak Gain

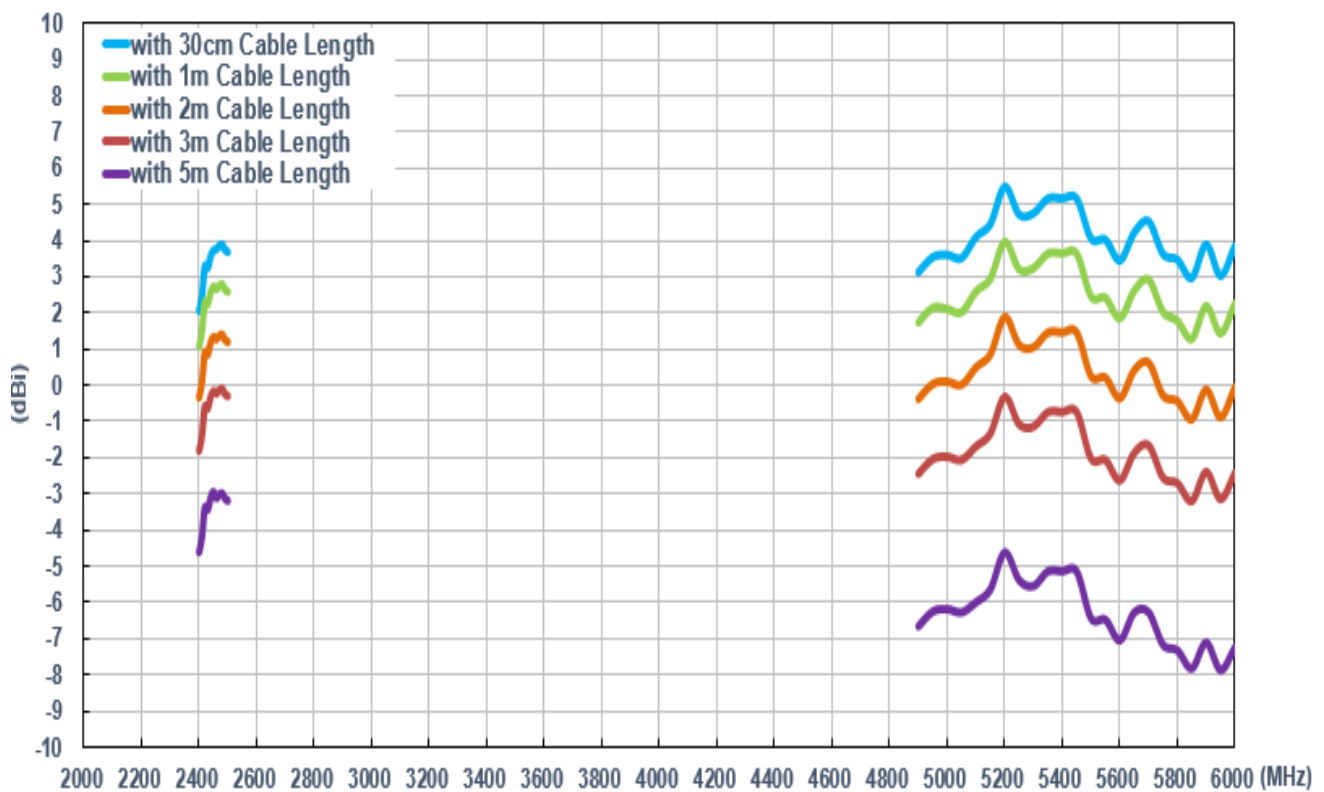

Changelog for the datasheet

SPE-16-8-053 - MA850.A.LBICG.001

Revision: D (Current Version)

Date:	2022-02-16
Changes:	Full datasheet update & new data up to 6GHz covered
Changes Made by:	Gary West

Previous Revisions

Revision: C

Date:	2018-10-12
Changes:	Updated drawing
Changes Made by:	Jack Conroy

Revision: B

Date:	2017-04-06
Changes:	Added LTE Band Table
Changes Made by:	Peter Monahan:

Revision: A (Original First Release)

Date:	2016-05-31
Notes:	
Author:	Technical Writer



TAOGLAS®

www.taoglas.com



Mouser Electronics

Authorized Distributor

Click to View Pricing, Inventory, Delivery & Lifecycle Information:

[Taoglas:](#)

[MA850.A.LBICG.001](#) [MA810.A.LBI.001](#)