



TAOGLAS®



Datasheet

Guardian 6-in-1 Antenna

Part No:
MA931.A.LBICGH.008

Description:

MA931 Guardian 6-in-1 Adhesive Mount Antenna GNSS + 5G/4G*2 + Wi-Fi*3

Features:

Low-profile Housing – Mounts flush to Wall

1* GPS-GLONASS-GALILEO-BeiDou Antenna

2* 5G/4G MIMO 600-6000MHz

3* Wi-Fi MIMO 2.4GHz/5.8GHz

Worldwide 4G Bands including 3G and 2G

IP67 Waterproof Enclosure

Dimensions: 146*134*20mm

Cables: 2m Low Loss TGC-200 for 5G/4G and Wi-Fi, 2m RG-174 for GNSS

Connectors: SMA(M) for 5G/4G and GNSS, RP-SMA(M) for Wi-Fi

Cables and Connectors Customizable

RoHS & Reach Compliant

1. Introduction	3
2. Specifications	4
3. Antenna Characteristics	10
4. 2D Radiation Patterns	19
5. Mechanical Drawing	33
6. Packaging	34
<hr/>	
Changelog	35

Taoglas makes no warranties based on the accuracy or completeness of the contents of this document and reserves the right to make changes to specifications and product descriptions at any time without notice. Taoglas reserves all rights to this document and the information contained herein.

Reproduction, use or disclosure to third parties without express permission is strictly prohibited.



1. Introduction



The MA931.A.LBICGH.008 Guardian is a next generation combination antenna. The first panel antenna worldwide designed for IoT Gateway and Router devices. It is a low profile 5in1 wall mount antenna. It is a heavy-duty, fully IP67 waterproof external M2M antenna for use by RF professionals in IoT Gateway and Routers, HD Video Streaming, Transportation and Remote Monitoring Applications.

This antenna delivers powerful MIMO antenna technology for worldwide 5G/4G bands at 600MHz - 6GHz, dual-band 2.4/5.8GHz Wi-Fi, and also can adding GPS-GLONASS-GALILEO-BeiDou for location accuracy. It enables designers to cover a wide range of technologies by installing a single antenna.

5G/4G wireless applications demand high speed data uplink and downlink. High efficiency and high gain MIMO antennas are necessary to achieve the required signal to noise ratio and throughput required to solve these challenges. Taoglas also takes care to have high isolation among these antennas to prevent self-interference. Low loss cables used to keep efficiency high over long cable lengths.

The GPS-GLONASS-GALILEO-BeiDou active antenna has been carefully designed for excellent performance across all GNSS bands, leading to higher location accuracy and stability of tracking in urban environments.

The housing is IP67 waterproof and comes with a 3M foam adhesive. The antenna can be mounted internally or externally on a vehicle. The MA931 comes with 2 meter, low loss TGC-200 coaxial cables for the 5G/4G and Wi-Fi antennas, and RG-174 coaxial cable for the GNSS antenna as standard. Customized cables and connector versions are also available, contact your regional Taoglas Customer support team for further information.

2. Specifications

GNSS Frequency Bands Covered							
GPS	L1	L2	L5				
	■	<input type="checkbox"/>	<input type="checkbox"/>				
GLONASS	G1	G2	G3				
	■	<input type="checkbox"/>	<input type="checkbox"/>				
Galileo	E1	E5a	E5b	E6			
	■	<input type="checkbox"/>	<input type="checkbox"/>	<input type="checkbox"/>			
BeiDou	B1	B2a	B2b	B3			
	■	<input type="checkbox"/>	<input type="checkbox"/>	<input type="checkbox"/>			
QZSS (Regional)	L1	L2C	L5	L6			
	■	<input type="checkbox"/>	<input type="checkbox"/>	<input type="checkbox"/>			
IRNSS (Regional)	L5						
	<input type="checkbox"/>						
SBAS	L1/E1/B1	L5/B2a/E5a	G1	G2	G3		
	■	<input type="checkbox"/>	■	<input type="checkbox"/>	<input type="checkbox"/>		

*SBAS systems: WASS(L1/L5), EGNOS(E1/E5a), SDCM(G1/G2/G3), SNAS(B1,B2a), GAGAN(L1/L5), QZSS(L1/L5), KAZZ(L1/L5).

GNSS Electrical			
Frequency (MHz)	1561	1575.42	1602
VSWR (max.)	3.0:1	3.0:1	3.0:1
Efficiency (%)	63	48	57
Peak Gain	3	2	3
Average Gain	-2	-3.1	-2.4
Axial Ratio (dB)	9.7	14	5.9
Polarization	RHCP		
Impedance	50Ω		

LNA and Filter Electrical Properties			
Frequency (MHz)	1561	1575.42	1602
VSWR (max.)	2:1	2:1	2:1
Gain@1.8V (Typ.)	28dB	28dB	28dB
Gain@3.0V (Typ.)	30dB	30dB	30dB
Gain@5.5V (Typ.)	33dB	33dB	33dB
Noise@1.8V (Typ.)	1.13dB	1.13dB	1.13dB
Noise@3.0V (Typ.)	1.13dB	1.13dB	1.13dB
Noise@5.5V (Typ.)	1.14dB	1.14dB	1.14dB
Power consumption@1.8V (Typ.)	7.9mA		
Power consumption@3.0V (Typ.)	9.0mA		
Power consumption@5.5V (Typ.)	9.9mA		
Return Loss	<10dB		
Total Specification (Through Antenna, SAW Filter and LNA)			
Frequency (MHz)	1561	1575.42	1602
Gain@3V (dBi)	28 ± 3	28 ± 3	28 ± 3
Output Impedance	50 Ω		

5G/4G 1										
Frequency (MHz)	617~698	698~806	824~894	880~960	1710~1880	1850~1990	1920~2170	2490~2690	3300~3500	5150~5925
Peak Gain (dBi)										
Free Space	3.81	3.81	3.73	4.06	4.61	3.91	3.98	4.60	4.32	4.48
With Ground plane (30x30cm)	4.31	0.67	3.59	2.70	4.42	3.67	6.76	7.75	6.71	6.25
Average Gain (dB)										
Free Space	-3.16	-3.02	-1.82	-1.18	-2.20	-3.19	-2.82	-1.56	-1.87	-2.77
With Ground plane (30x30cm)	-3.86	-5.14	-3.14	-2.88	-2.61	-3.61	-3.40	-2.02	-2.37	-3.05
Efficiency (%)										
Free Space	48.36	49.88	65.81	76.26	60.19	47.98	52.28	69.81	65.06	52.86
With Ground plane (30x30cm)	41.07	30.65	48.53	51.47	54.84	43.60	45.75	62.75	57.99	49.52
5G/4G 2										
Frequency (MHz)	617~698	698~806	824~894	880~960	1710~1880	1850~1990	1920~2170	2490~2690	3300~3500	5150~5925
Peak Gain (dBi)										
Free Space	3.49	2.50	3.55	3.97	4.06	4.43	5.14	5.58	3.93	4.70
With Ground plane (30x30cm)	2.93	1.76	3.40	3.40	4.42	3.67	6.76	7.75	6.71	6.24
Average Gain (dB)										
Free Space	-2.79	-2.94	-2.12	-1.40	-2.13	-3.01	-2.43	-1.44	-1.62	-3.09
With Ground plane (30x30cm)	-3.27	-4.21	-3.60	-3.27	-2.61	-3.61	-3.40	-2.02	-2.37	-2.87
Efficiency (%)										
Free Space	52.60	50.82	61.43	72.48	61.25	50.02	57.18	71.76	68.79	49.52
With Ground plane (30x30cm)	47.11	37.91	43.70	47.09	54.84	43.60	45.75	62.75	57.99	51.67
Impedance	50Ω									
Polarization	Linear									
Radiation Pattern	Omni									
Input Power	50 W									

Wi-Fi 1		
Frequency (MHz)	2400~2500	5150~5850
Peak Gain (dBi)		
Free Space	4.25	5.57
With Ground plane(30x30cm)	7.08	8.14
Average Gain (dB)		
Free Space	-1.63	-1.88
With Ground plane(30x30cm)	-1.94	-2.36
Efficiency (%)		
Free Space	68.68	64.93
With Ground plane(30x30cm)	63.91	58.11
Wi-Fi 2		
Frequency (MHz)	2400~2500	5150~5850
Peak Gain (dBi)		
Free Space	5.12	6.41
With Ground plane(30x30cm)	8.80	7.45
Average Gain (dB)		
Free Space	-1.59	-2.17
With Ground plane(30x30cm)	-2.08	-2.53
Efficiency (%)		
Free Space	69.42	60.69
With Ground plane(30x30cm)	61.94	55.85
Wi-Fi 3		
Frequency (MHz)	2400~2500	5150~5850
Peak Gain (dBi)		
Free Space	4.77	5.04
With Ground plane(30x30cm)	6.71	7.89
Average Gain (dB)		
Free Space	-1.60	-1.95
With Ground plane(30x30cm)	-1.87	-2.37
Efficiency (%)		
Free Space	69.18	63.79
With Ground plane(30x30cm)	64.99	57.89
Impedance	50Ω	
Polarization	Linear	
Radiation Pattern	Omni	
Input Power	50 W	

Mechanical	
Height	20 ±2 mm
Base Diameter	146*134mm
Casing	ASA
Connector	RP-SMA Male
Environmental	
Temperature Range	-40°C to 85°C
Humidity	Non-condensing 65°C 95% RH

5G/4G Bands			
Band Number	5G NR / FR1 / LTE / LTE-Advanced / WCDMA / HSPA / HSPA+ / TD-SCDMA		
	Uplink	Downlink	Covered
1	UL: 1920 to 1980	DL: 2110 to 2170	✓
2	UL: 1850 to 1910	DL: 1930 to 1990	✓
3	UL: 1710 to 1785	DL: 1805 to 1880	✓
4	UL: 1710 to 1755	DL: 2110 to 2155	✓
5	UL: 824 to 849	DL: 869 to 894	✓
7	UL: 2500 to 2570	DL: 2620 to 2690	✓
8	UL: 880 to 915	DL: 925 to 960	✓
9	UL: 1749.9 to 1784.9	DL: 1844.9 to 1879.9	✓
11	UL: 1427.9 to 1447.9	DL: 1475.9 to 1495.9	✓
12	UL: 699 to 716	DL: 729 to 746	✓
13	UL: 777 to 787	DL: 746 to 756	✓
14	UL: 788 to 798	DL: 758 to 768	✓
17	UL: 704 to 716	DL: 734 to 746	✓
18	UL: 815 to 830	DL: 860 to 875	✓
19	UL: 830 to 845	DL: 875 to 890	✓
20	UL: 832 to 862	DL: 791 to 821	✓
21	UL: 1447.9 to 1462.9	DL: 1495.9 to 1510.9	✓
22	UL: 3410 to 3490	DL: 3510 to 3590	✓
23	UL: 2000 to 2020	DL: 2180 to 2200	✓
24	UL: 1625.5 to 1660.5	DL: 1525 to 1559	✓
25	UL: 1850 to 1915	DL: 1930 to 1995	✓
26	UL: 814 to 849	DL: 859 to 894	✓
27	UL: 807 to 824	DL: 852 to 869	✓
28	UL: 703 to 748	DL: 758 to 803	✓
29	UL: -	DL: 717 to 728	✓
30	UL: 2305 to 2315	DL: 2350 to 2360	✓
31	UL: 452.5 to 457.5	DL: 462.5 to 467.5	✗
32	UL: -	DL: 1452 - 1496	✓
35		1850 to 1910	✓
38		2570 to 2620	✓
39		1880 to 1920	✓
40		2300 to 2400	✓
41		2496 to 2690	✓
42		3400 to 3600	✓
43		3600 to 3800	✓
48		3550 to 3700	✓
66	UL: 1710-1780	DL: 2110-2200	✓
71		617 to 698	✓
74/75/76		1427 to 1518	✓
78		3300 to 3800	✓
79		4400 to 5000	✓

3. Antenna Characteristics

3.1 VSWR

5G/4G

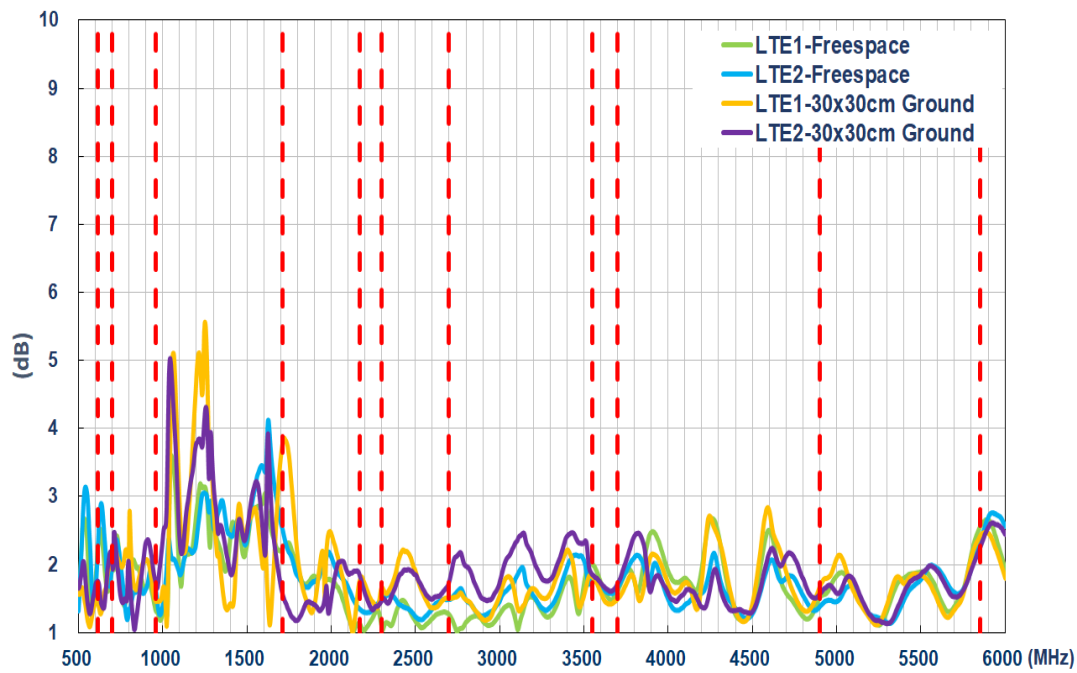

Wi-Fi

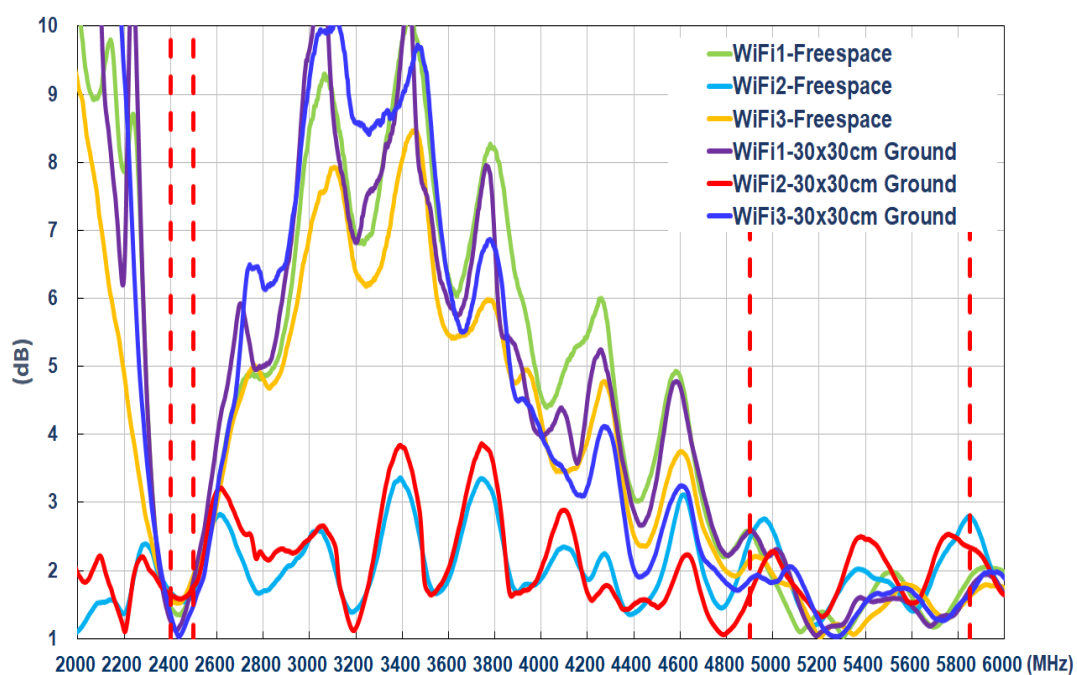

3.2 Isolation

5G/4G

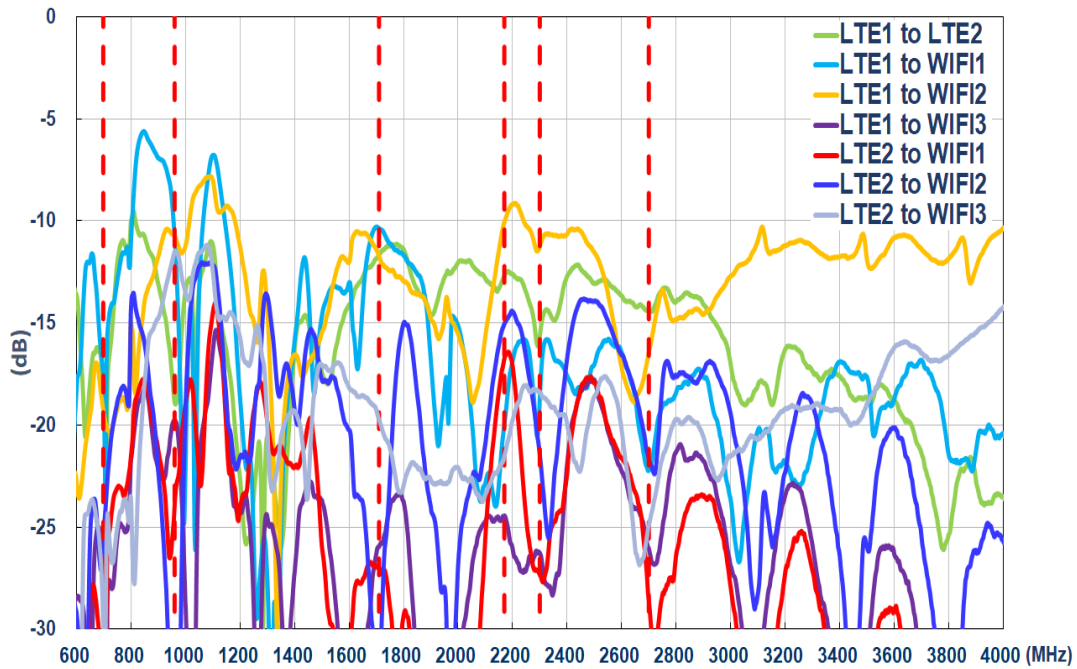

Wi-Fi

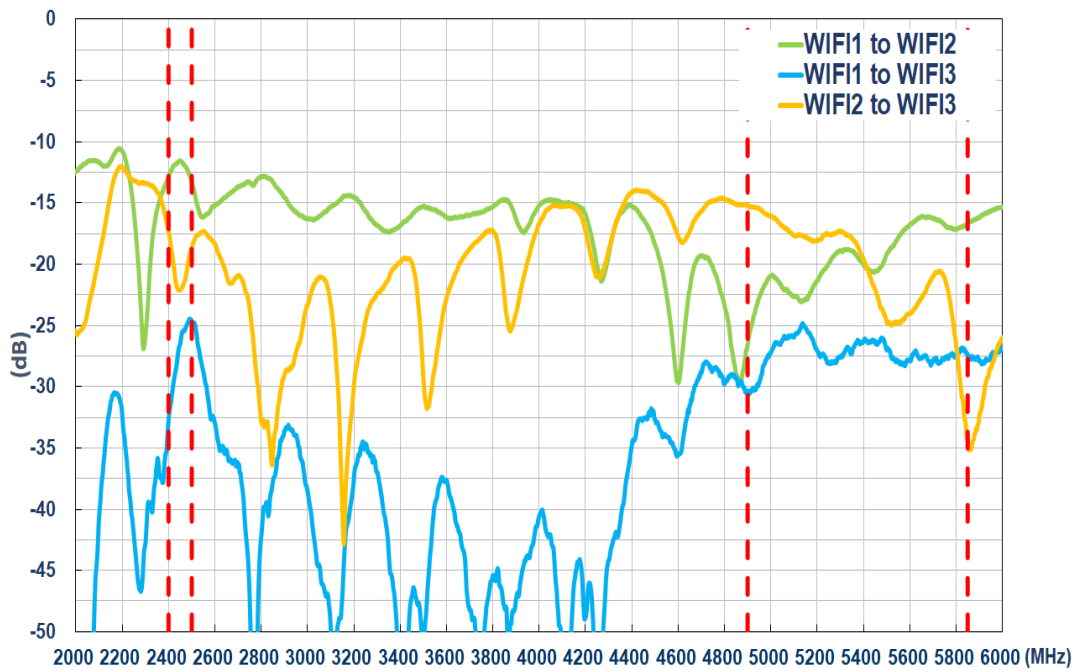

3.3 Efficiency

5G/4G

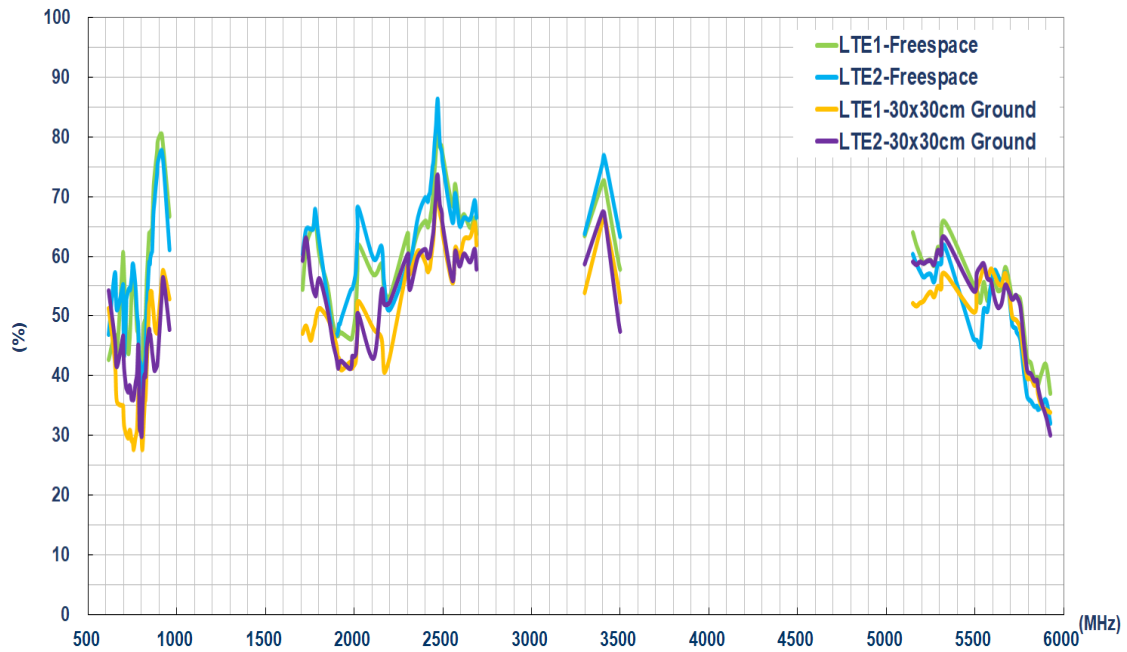

Wi-Fi

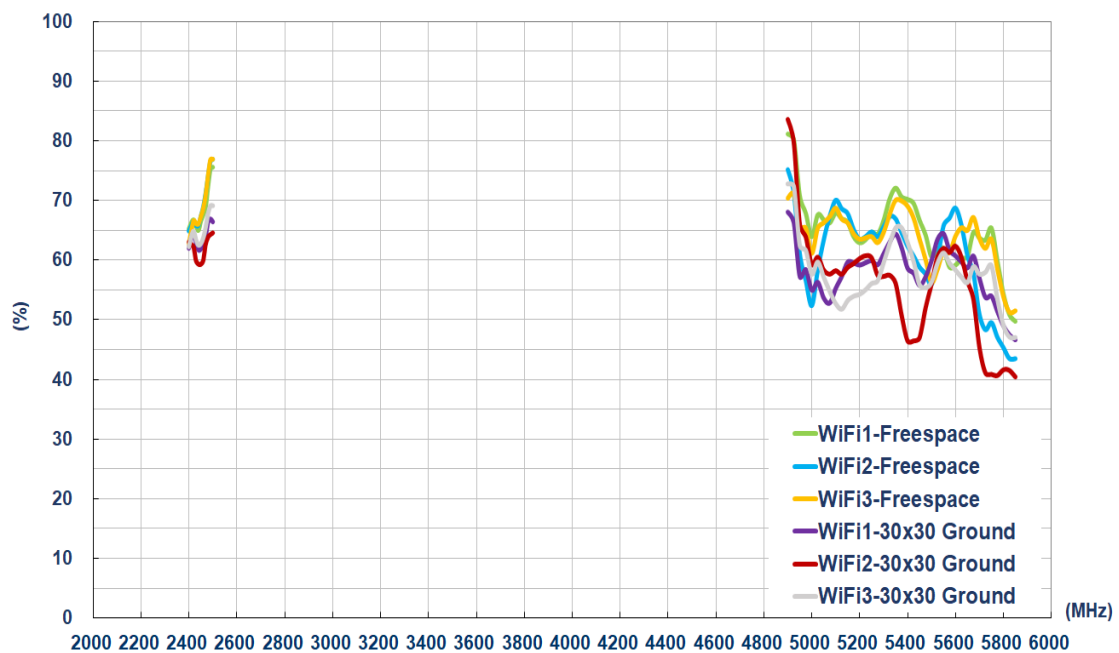

GNSS

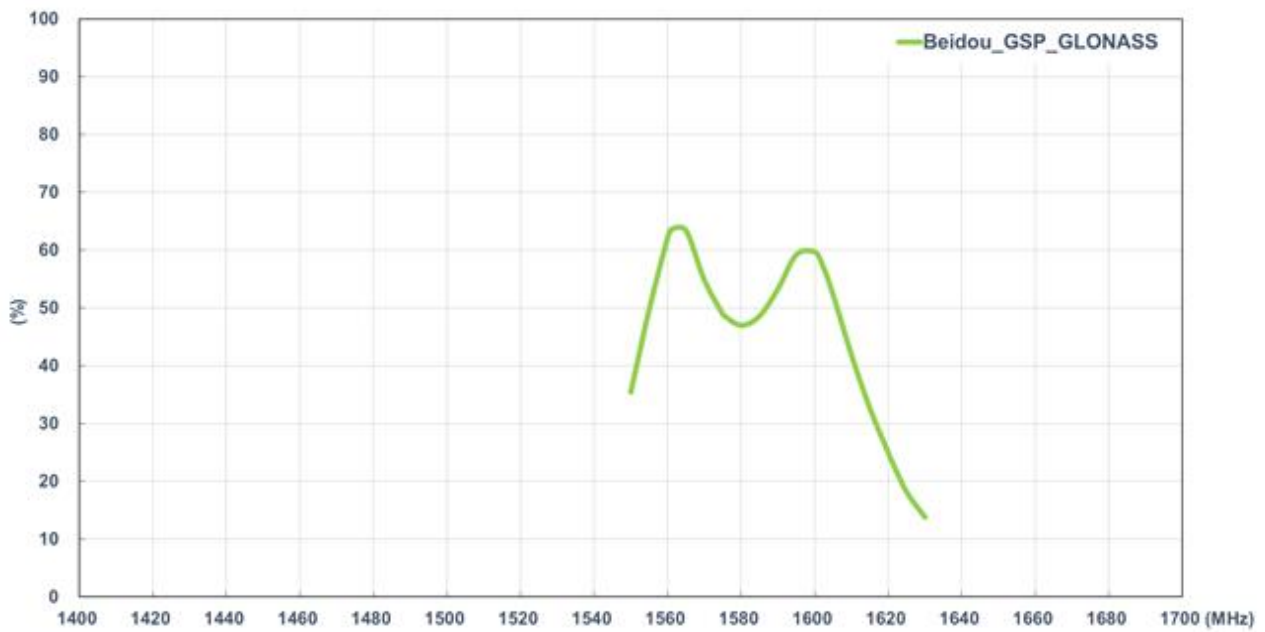

3.4 Average Gain

5G/4G

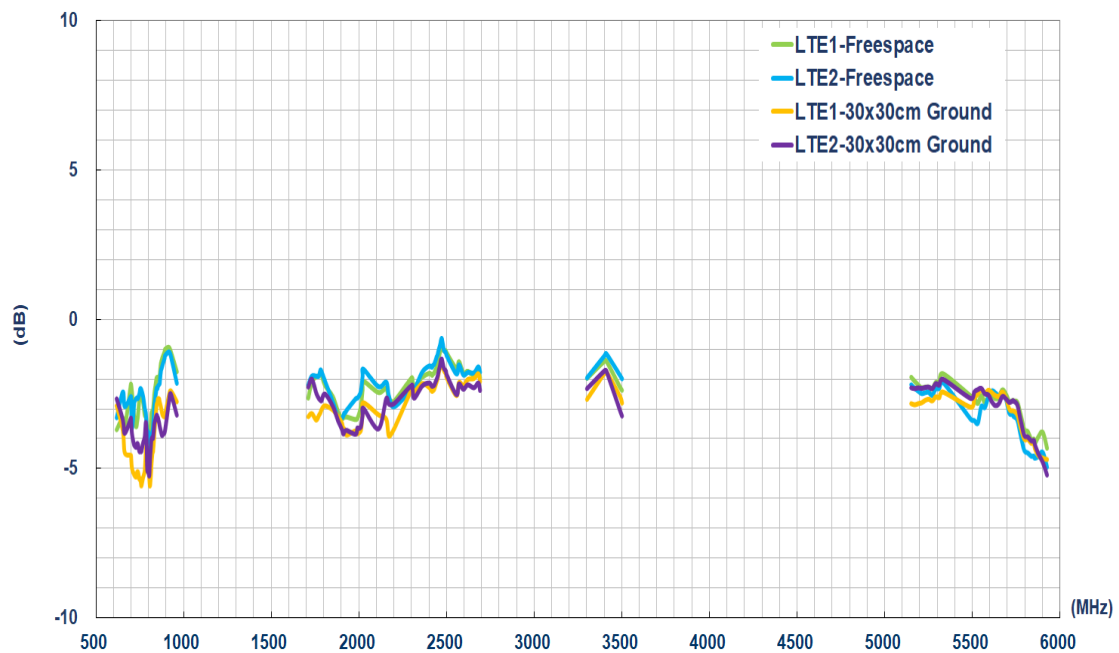

Wi-Fi

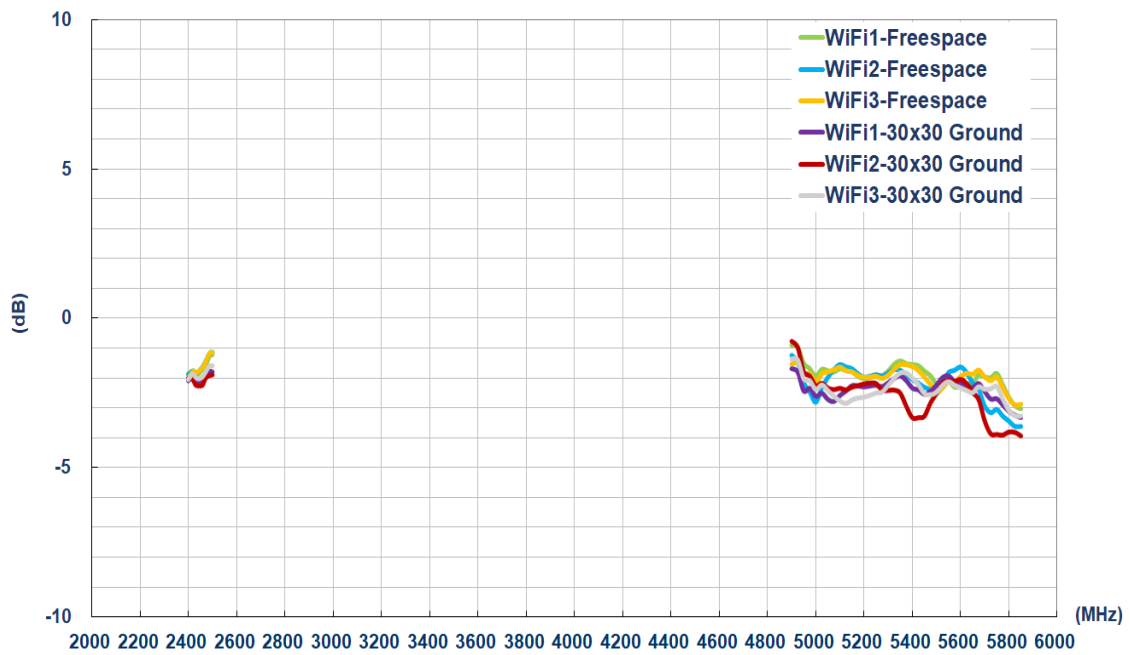

GNSS

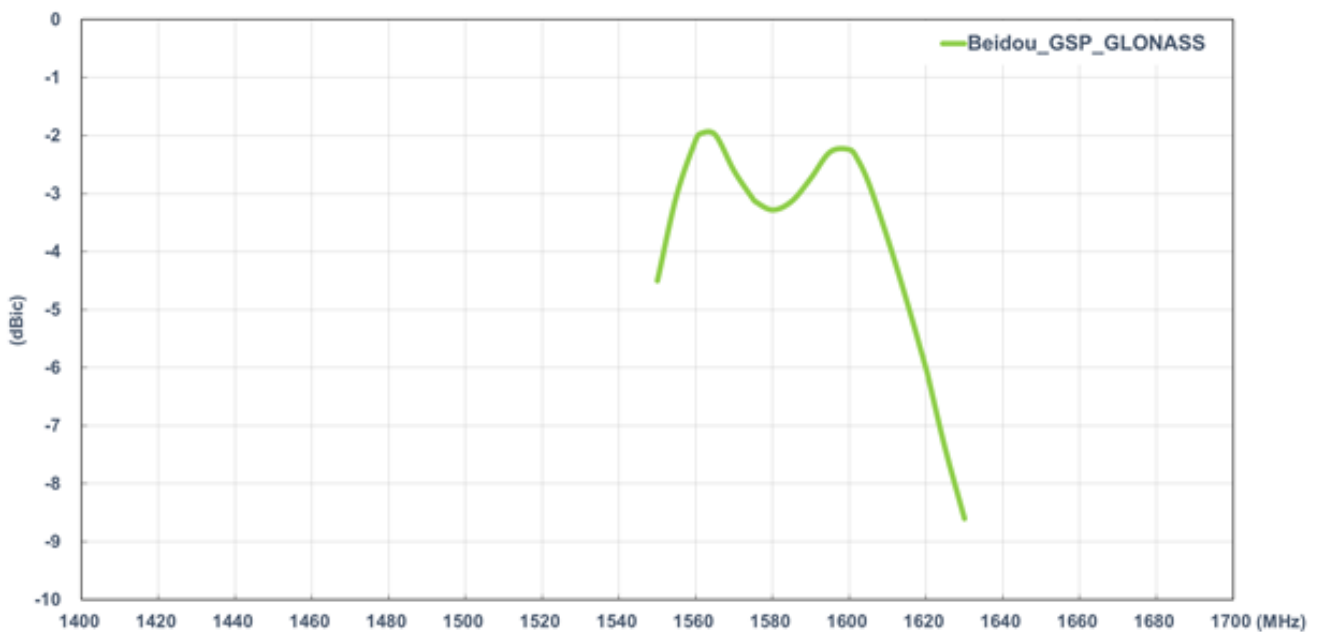

3.5 Peak Gain

5G/4G

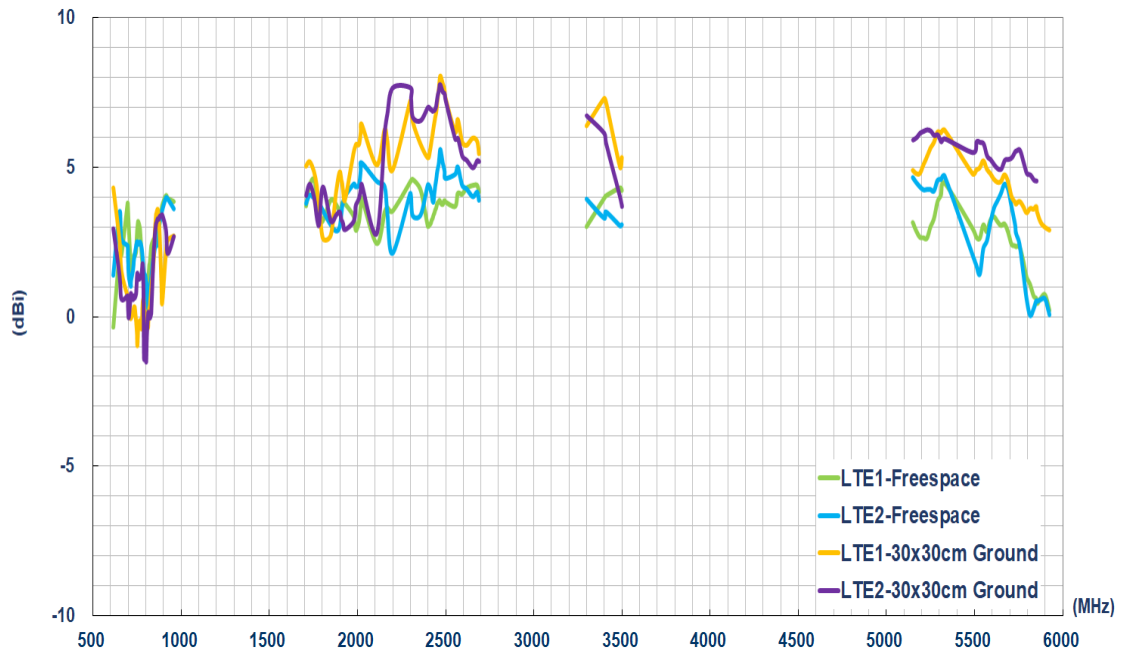

Wi-Fi

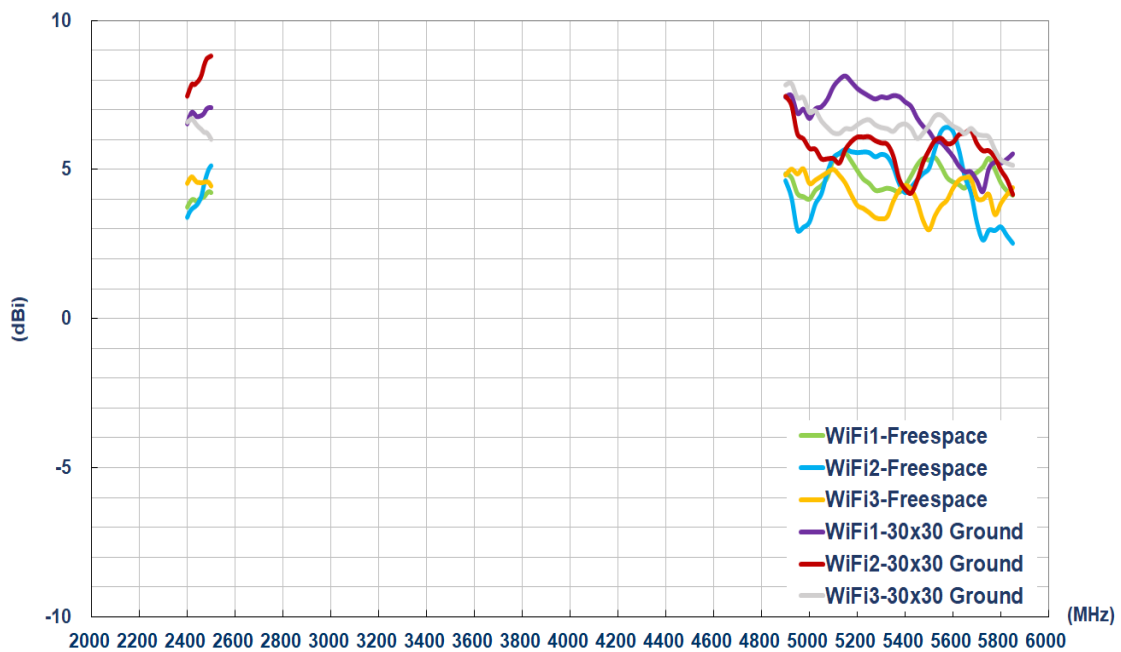

GNSS

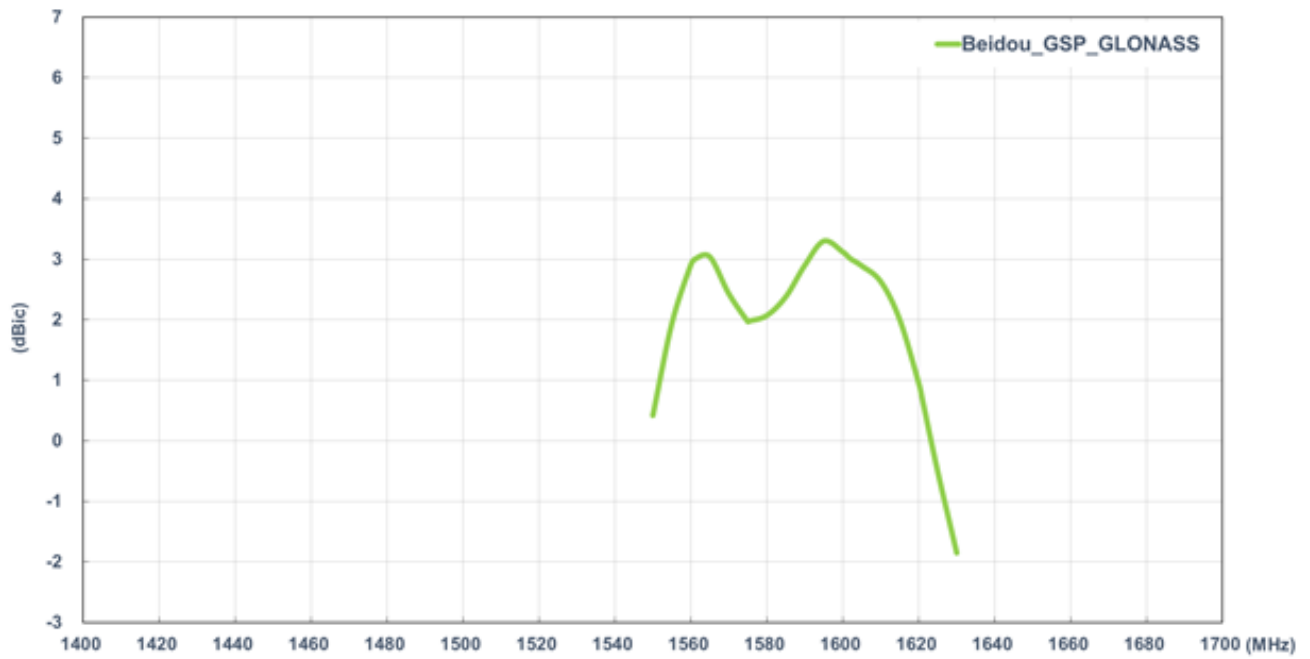

3.6 Axial Ratio

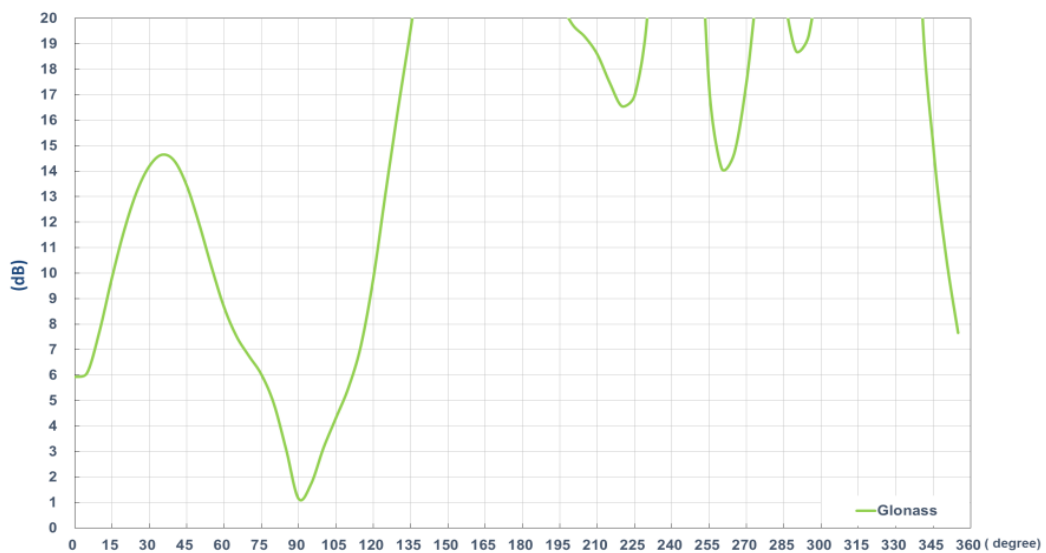
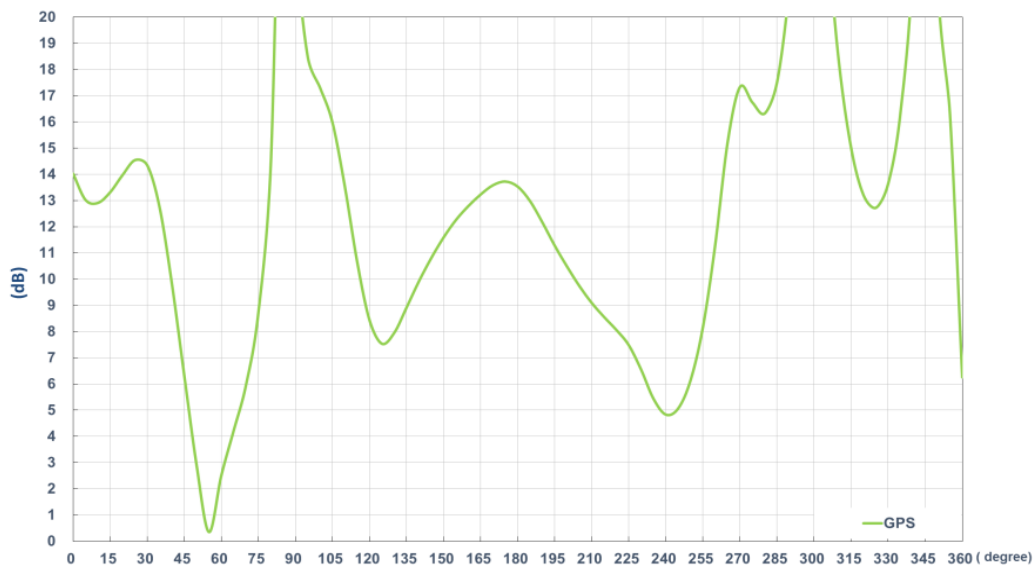
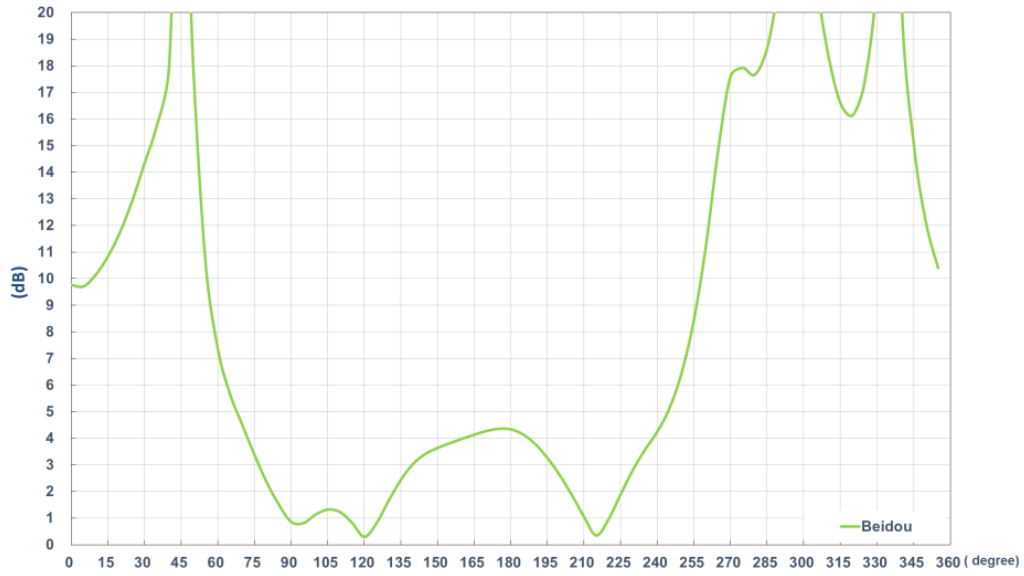

3.7 LNA Gain @3.0V

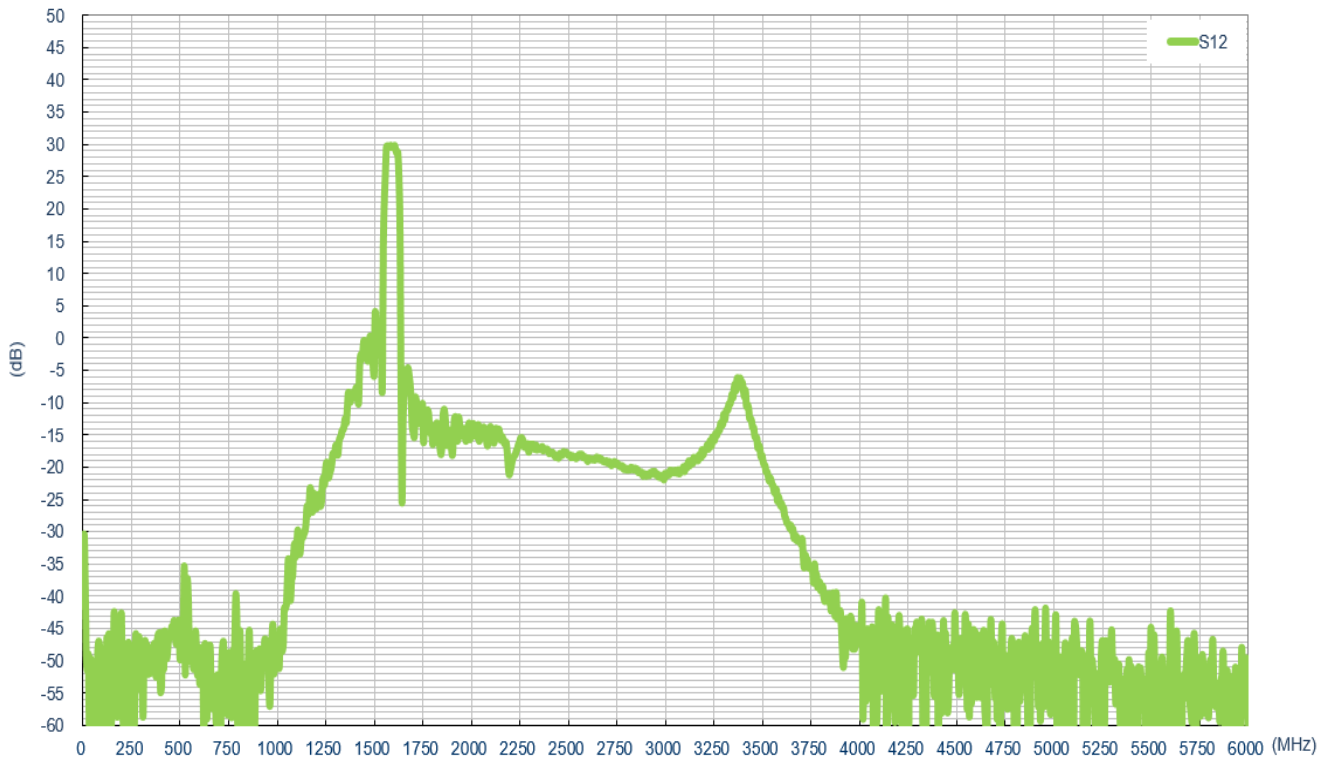

3.8 LNA Noise

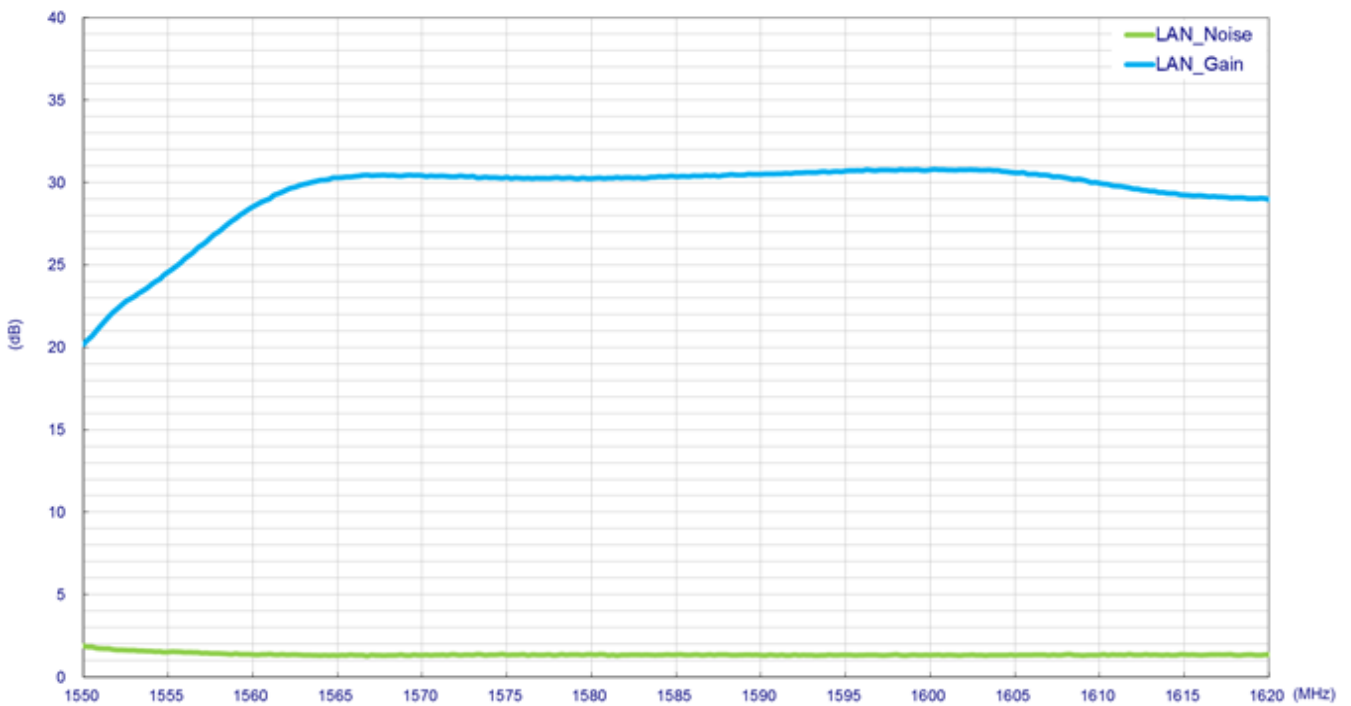

4. 2D Radiation Patterns(With 30cm cable length)

4.1 Test Setup



Free space



30x30cm ground

4.2 2D Radiation Patterns

4.2.1 5G/4G 1 Antenna-Free space

XY Plane

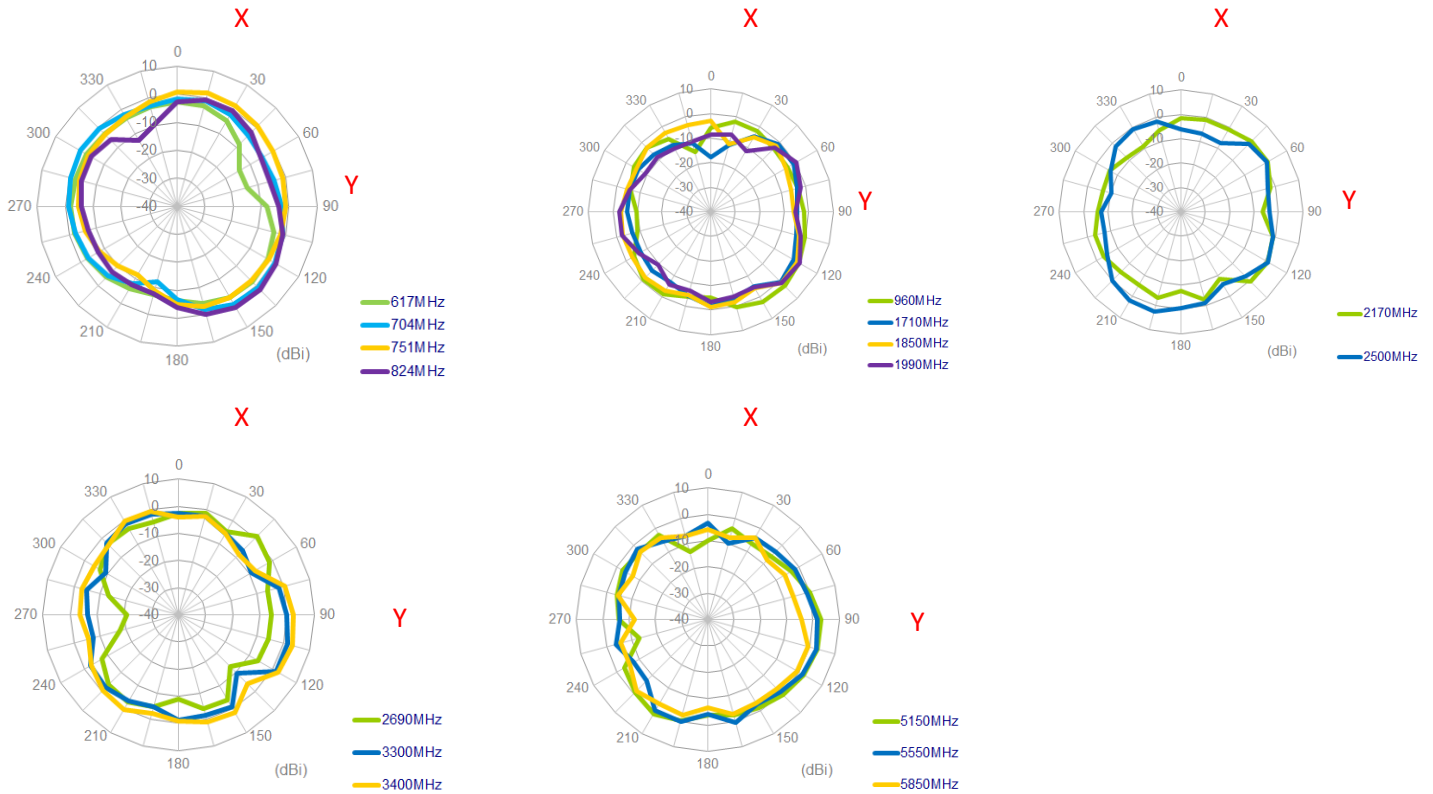

XZ Plane

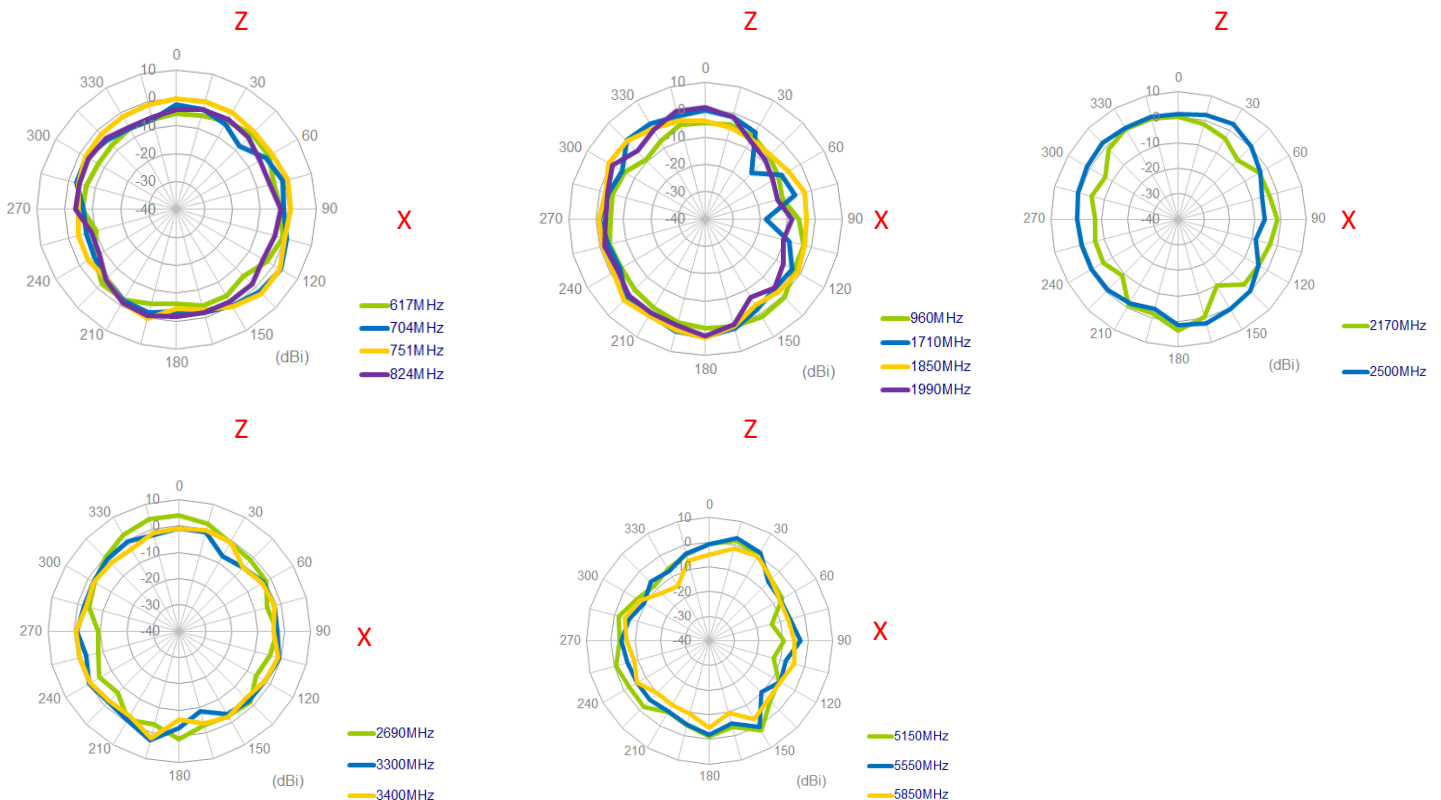

YZ Plane

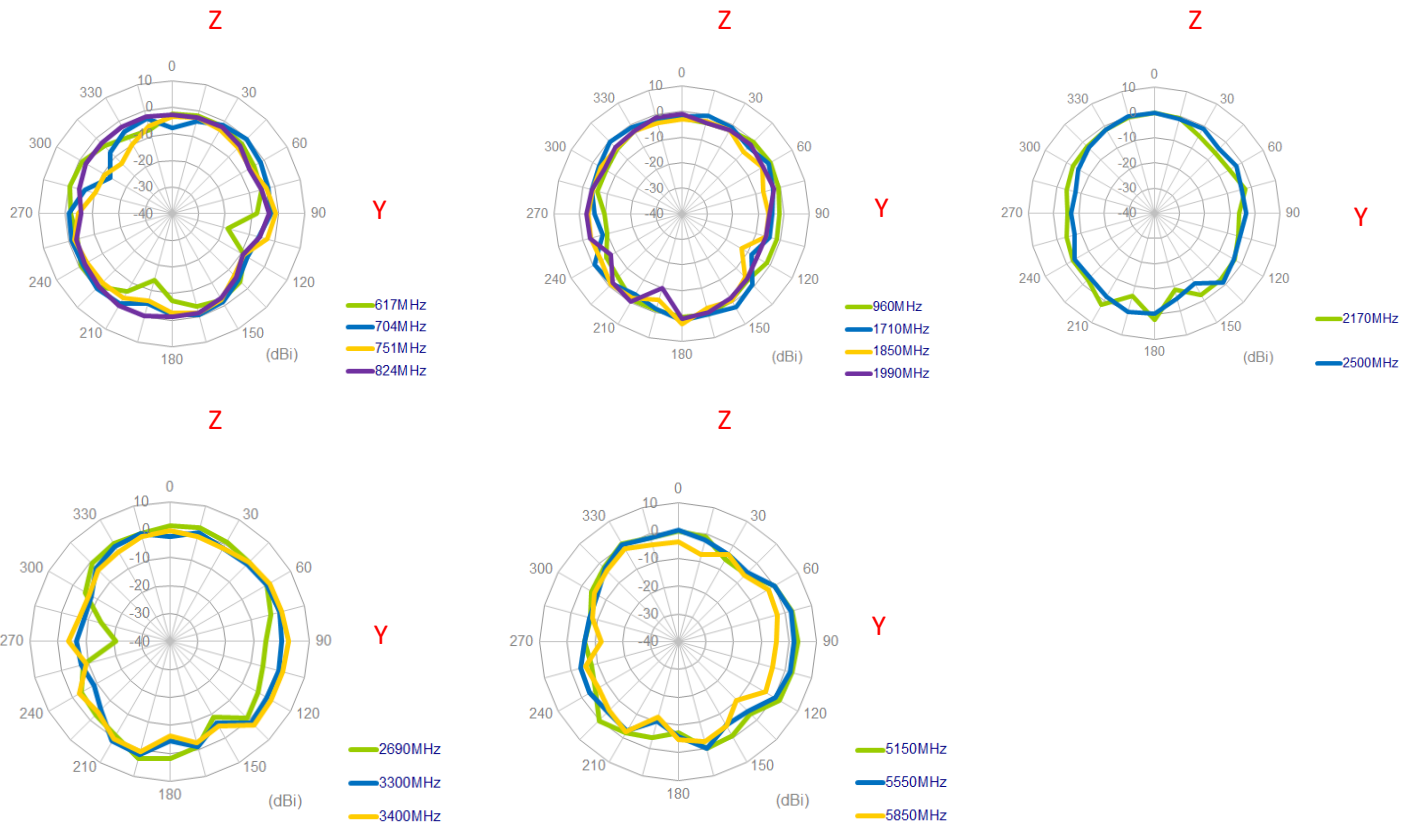

4.2.2 5G/4G 2 Antenna-Free space

XY Plane

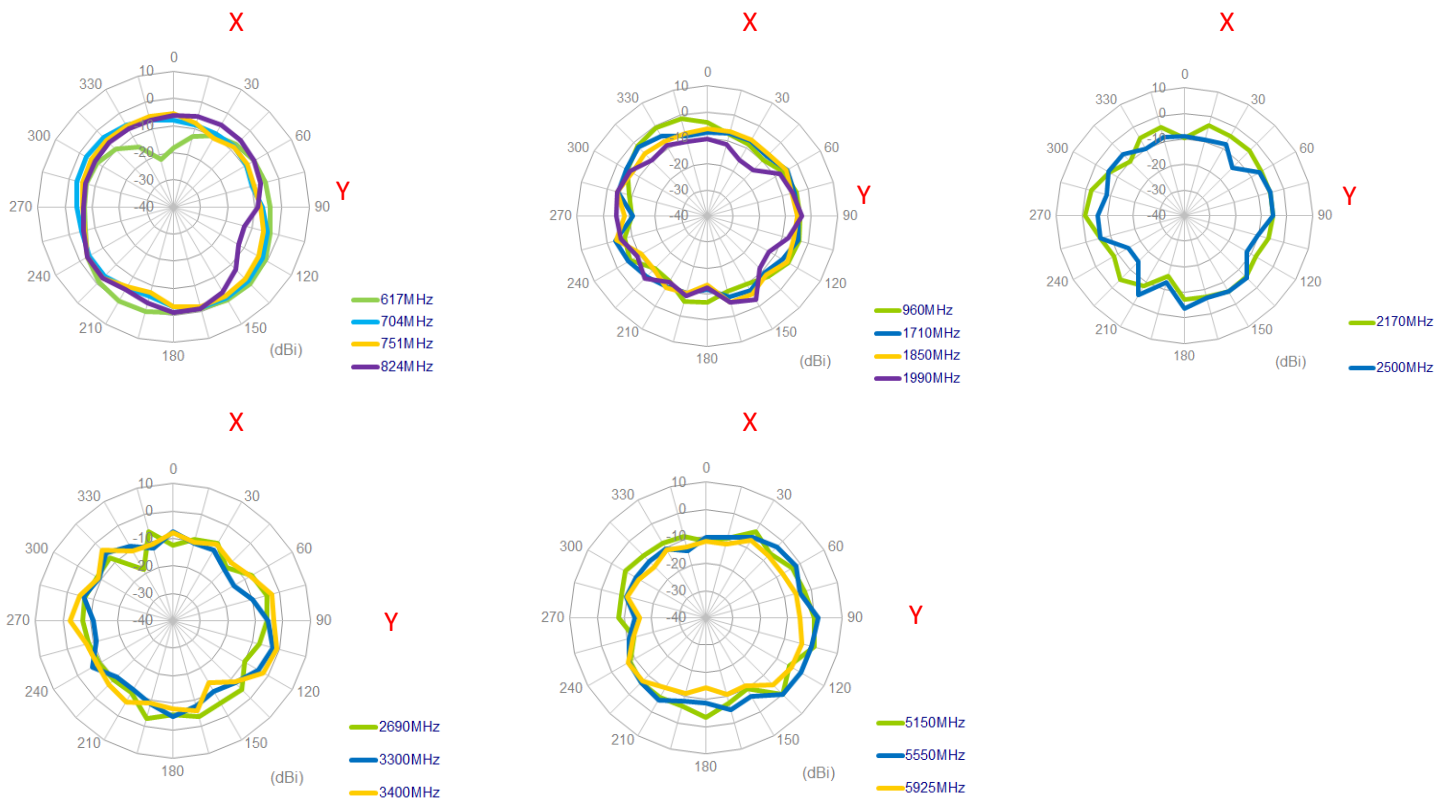

XZ Plane

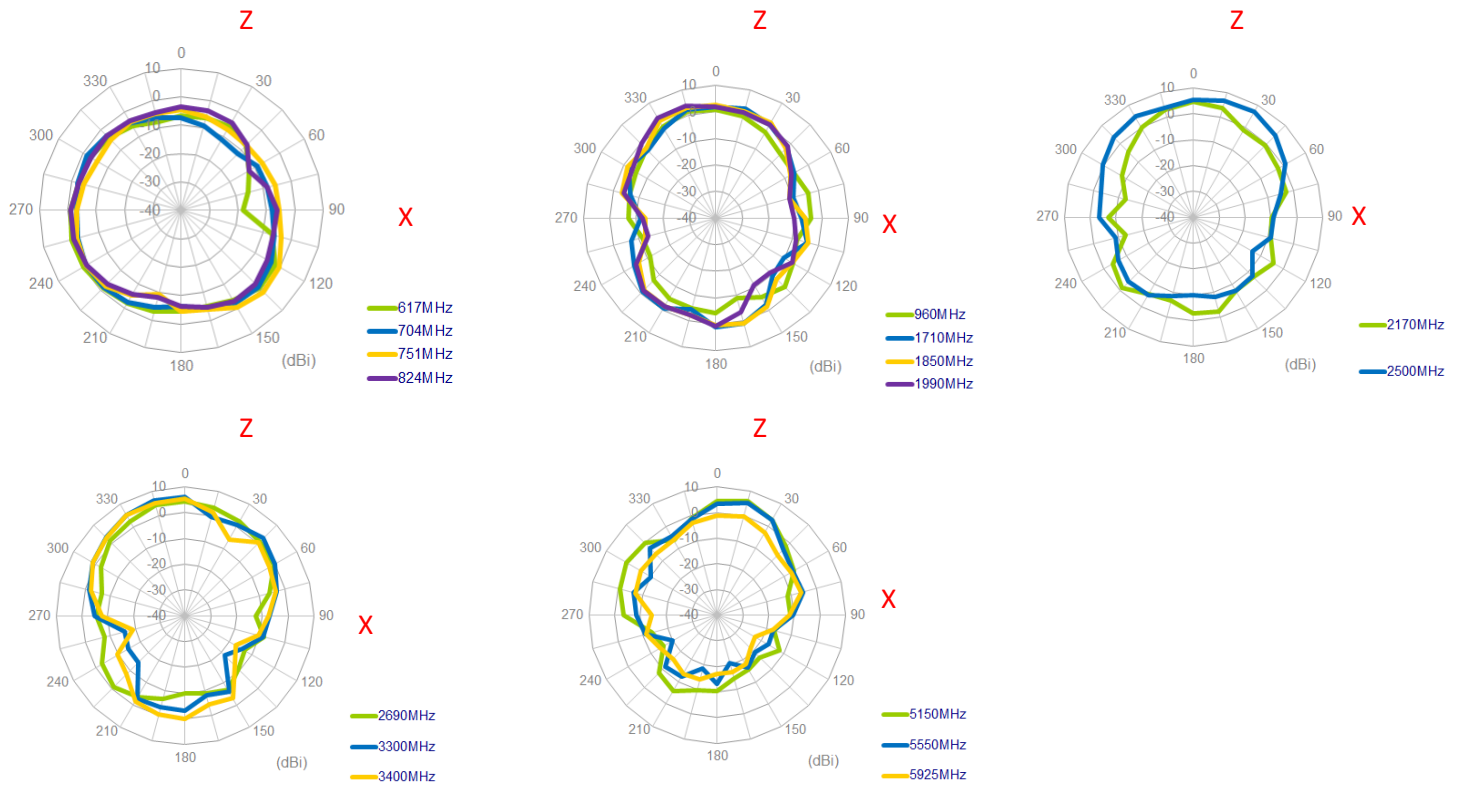

YZ Plane

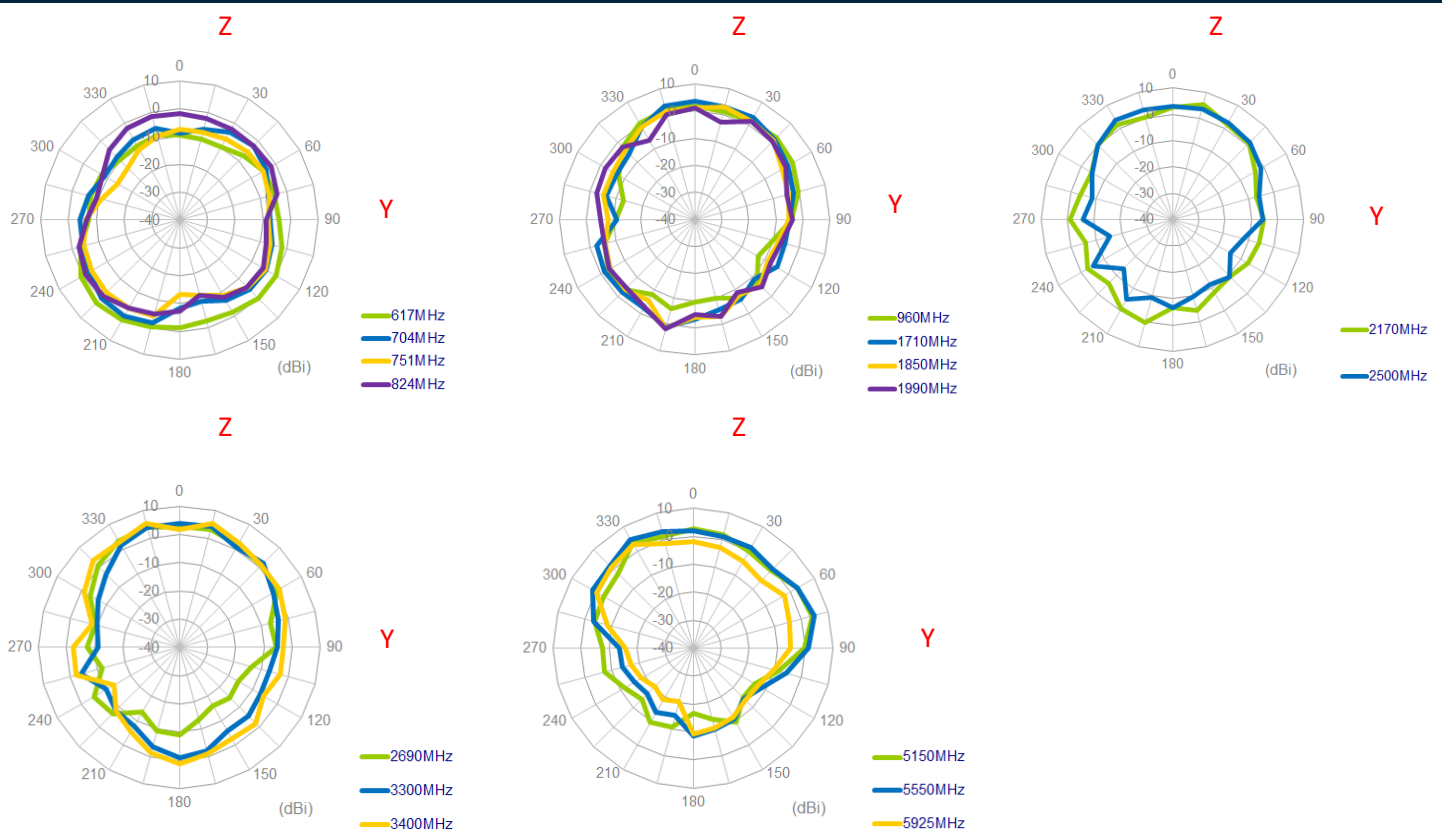

4.2.3 Wi-Fi 1 Antenna-Free space

XY Plane

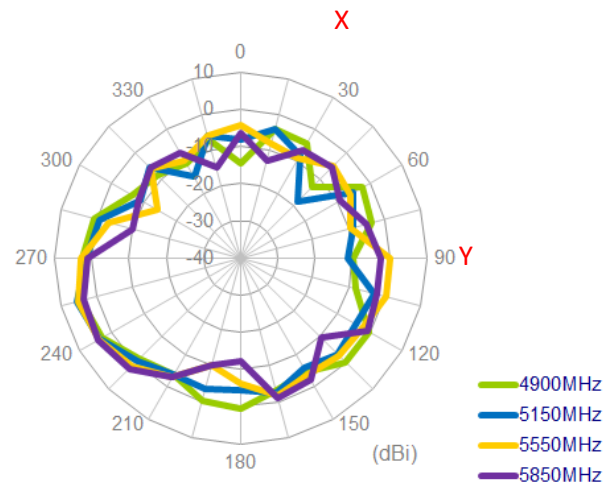
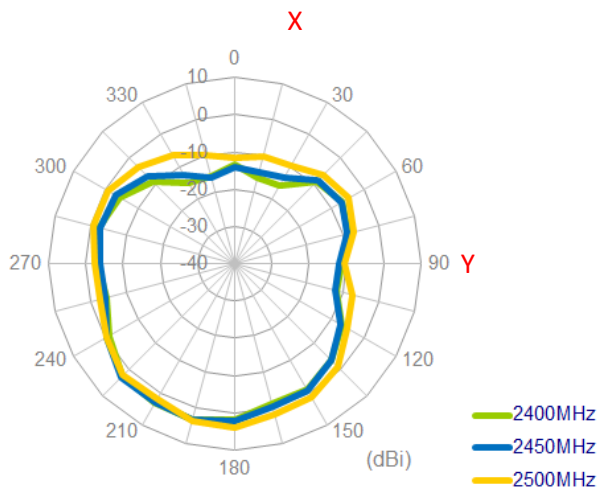

XZ Plane

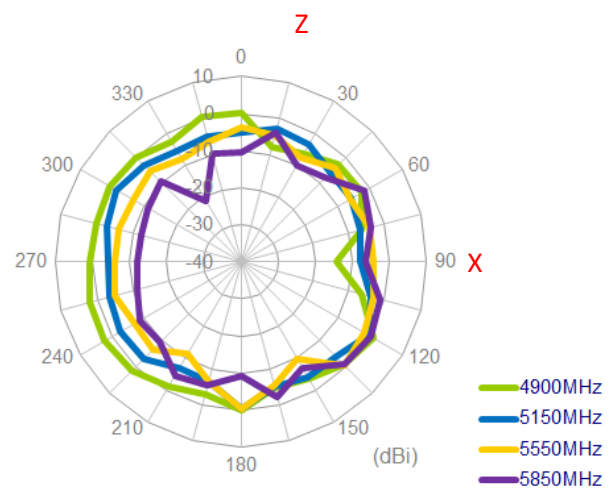
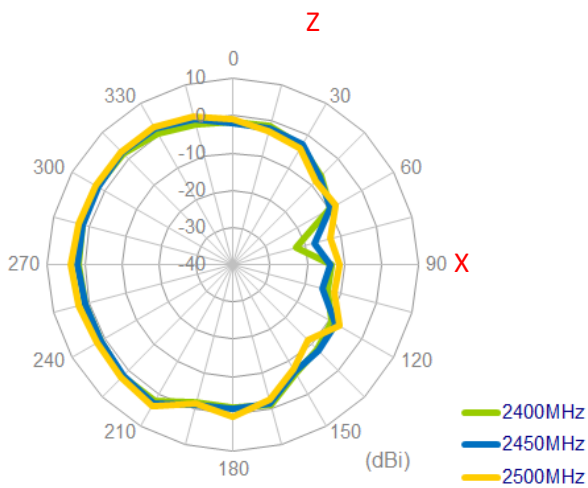

YZ Plane

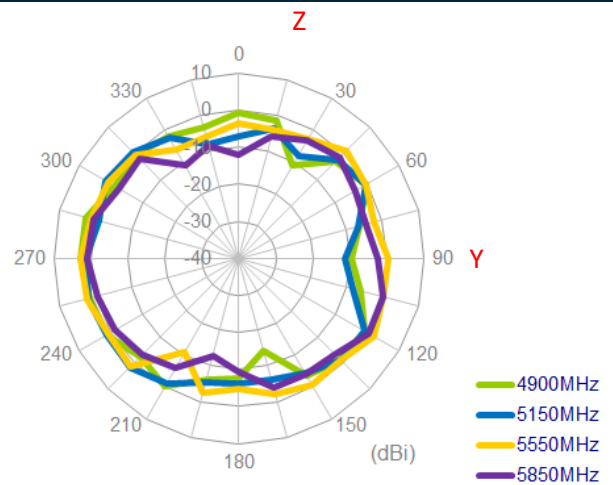
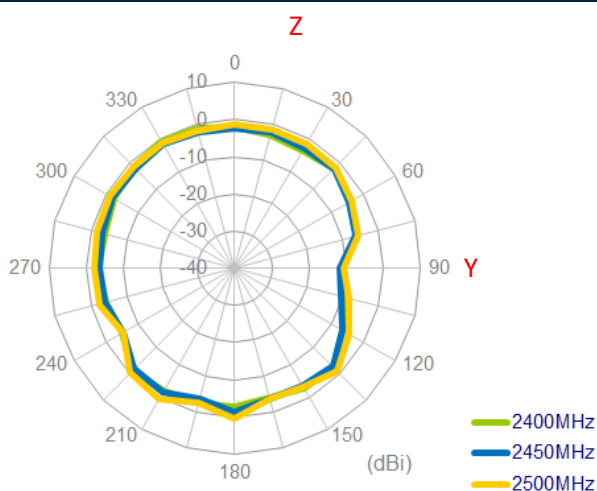

4.2.4 Wi-Fi 2 Antenna-Free space

XY Plane

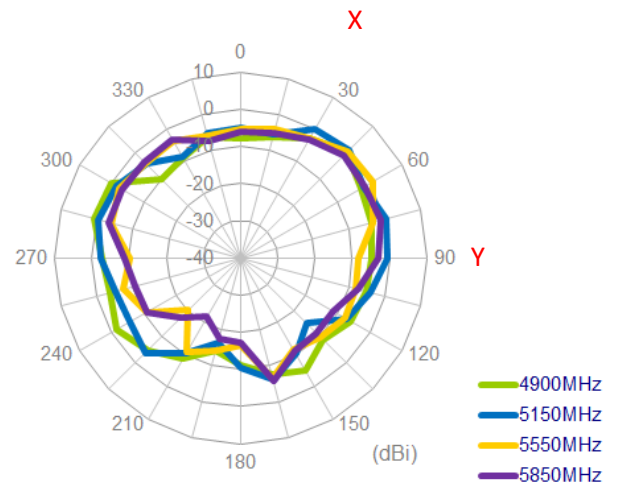
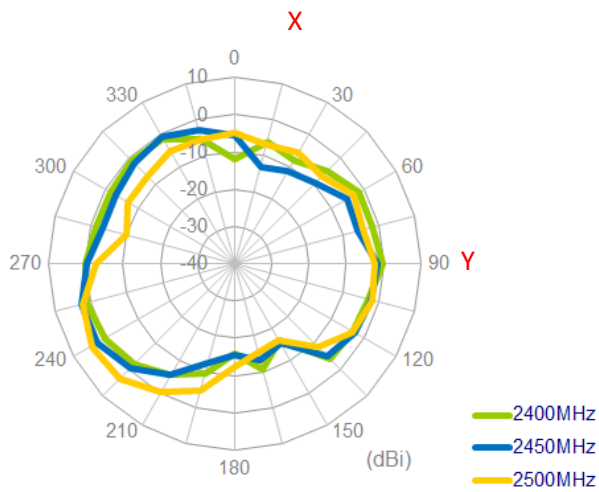

XZ Plane

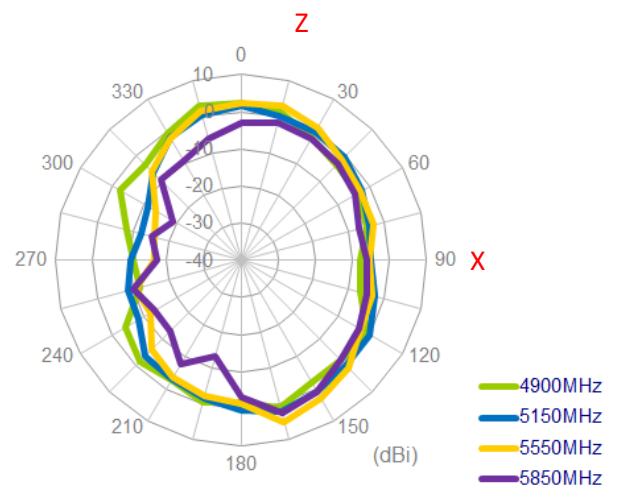
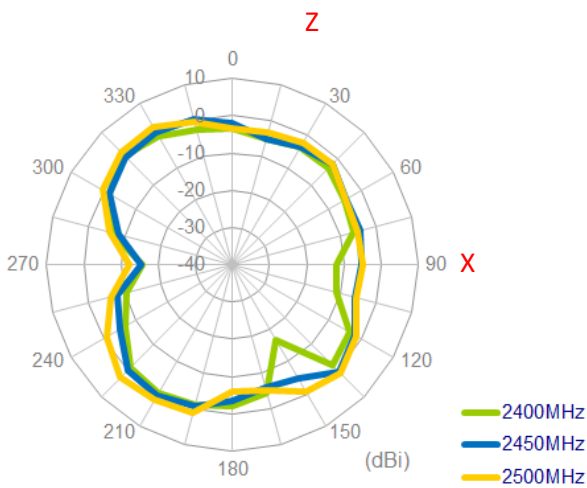

YZ Plane

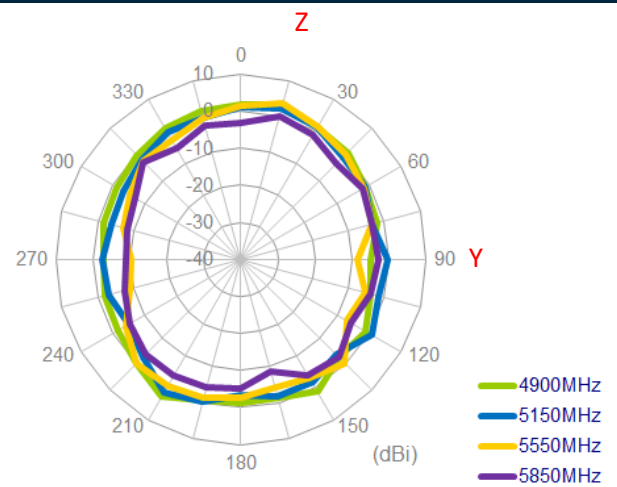
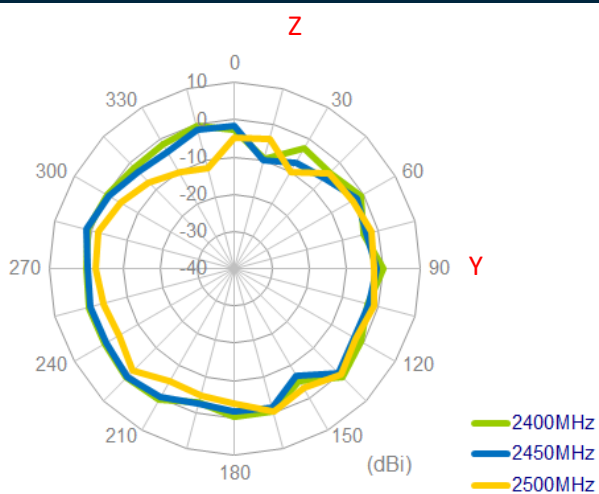

4.2.5 Wi-Fi 3 Antenna-Free space

XY Plane

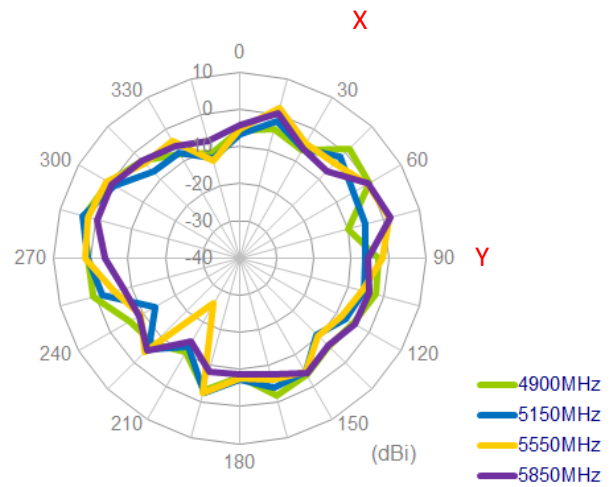
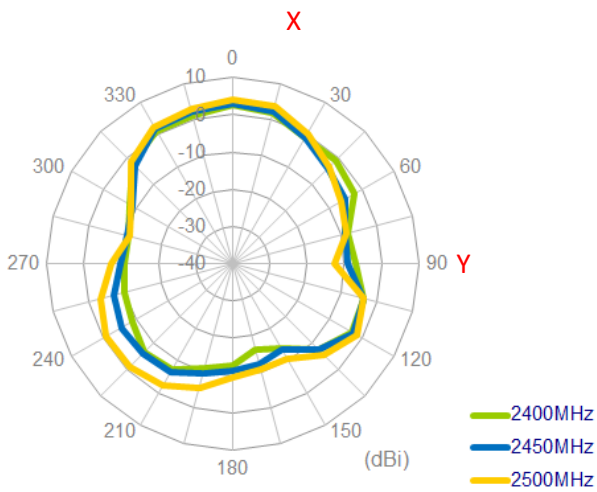

XZ Plane

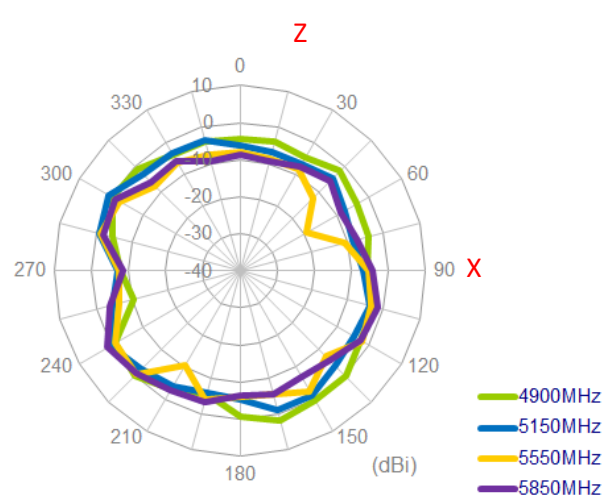
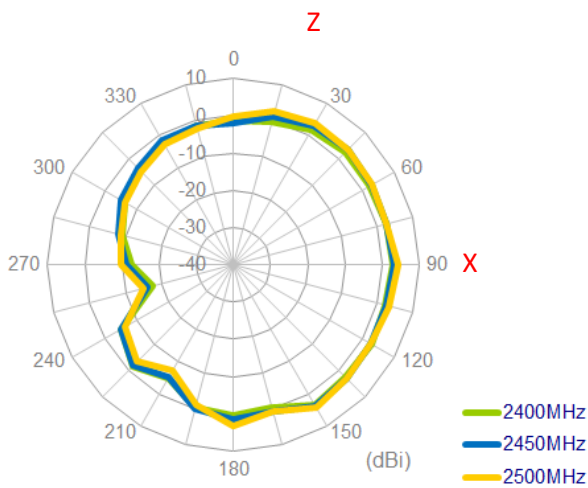

YZ Plane

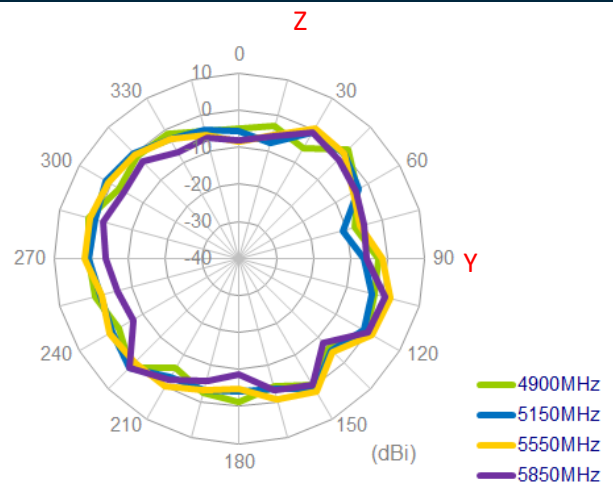
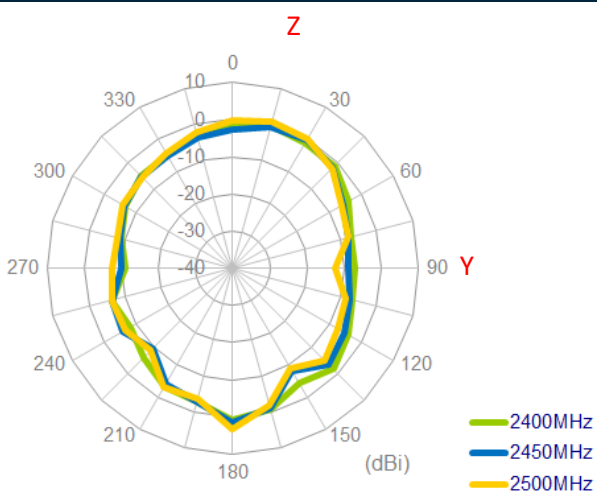

4.2.6 5G/4G 1 Antenna-30x30cm Ground

XY Plane

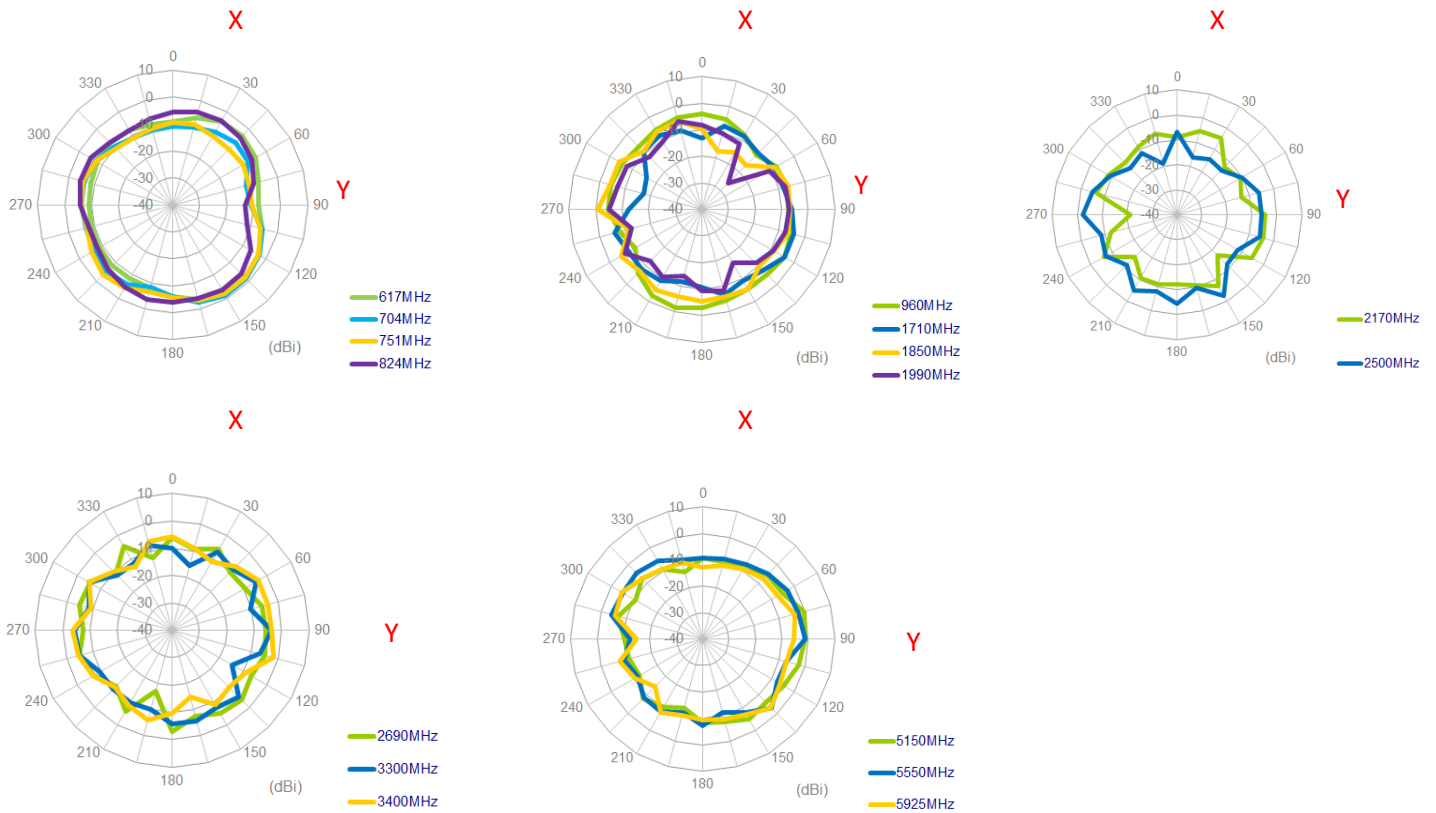

XZ Plane

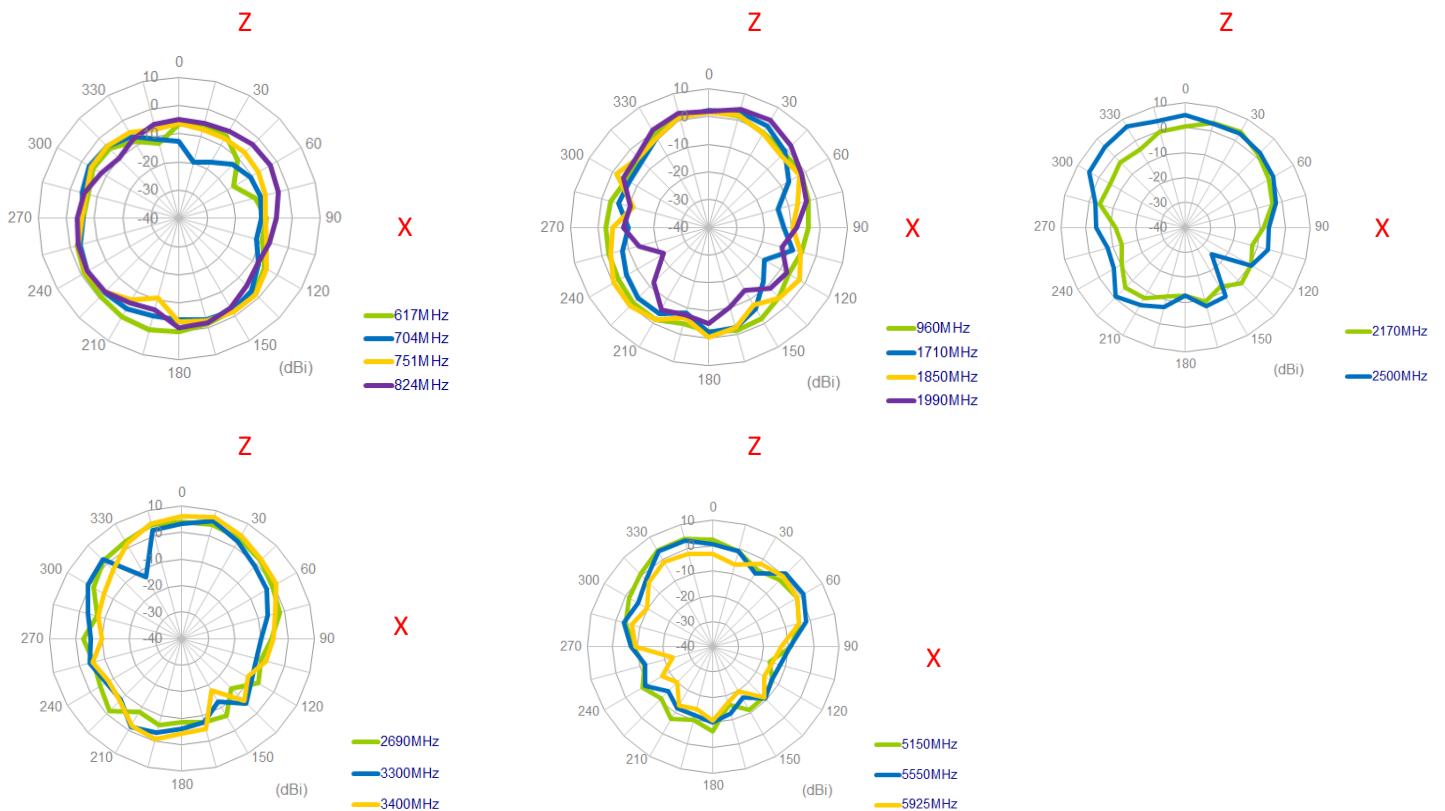

YZ Plane

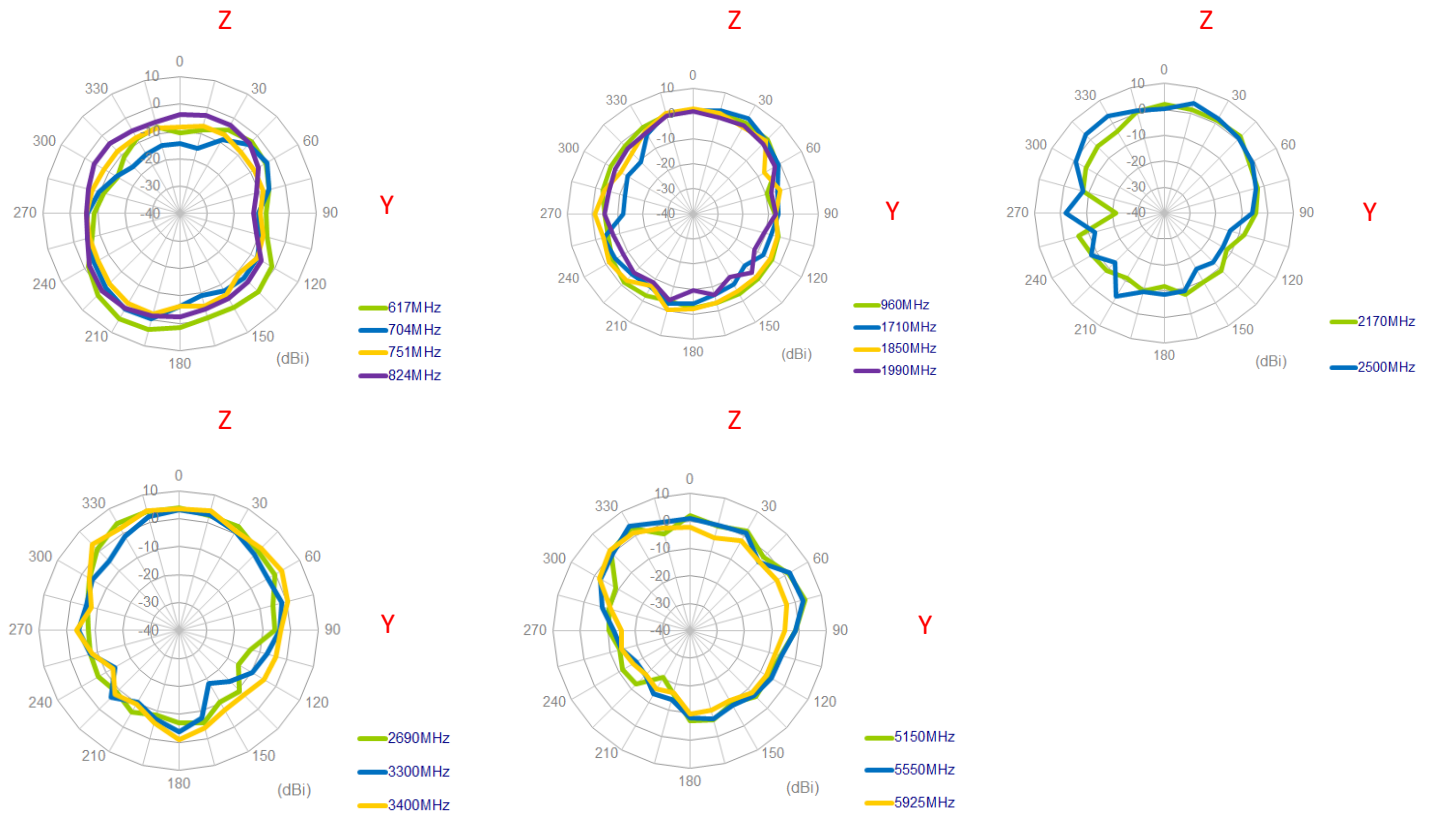

4.2.7 5G/4G 2 Antenna-30x30cm Ground

XY Plane

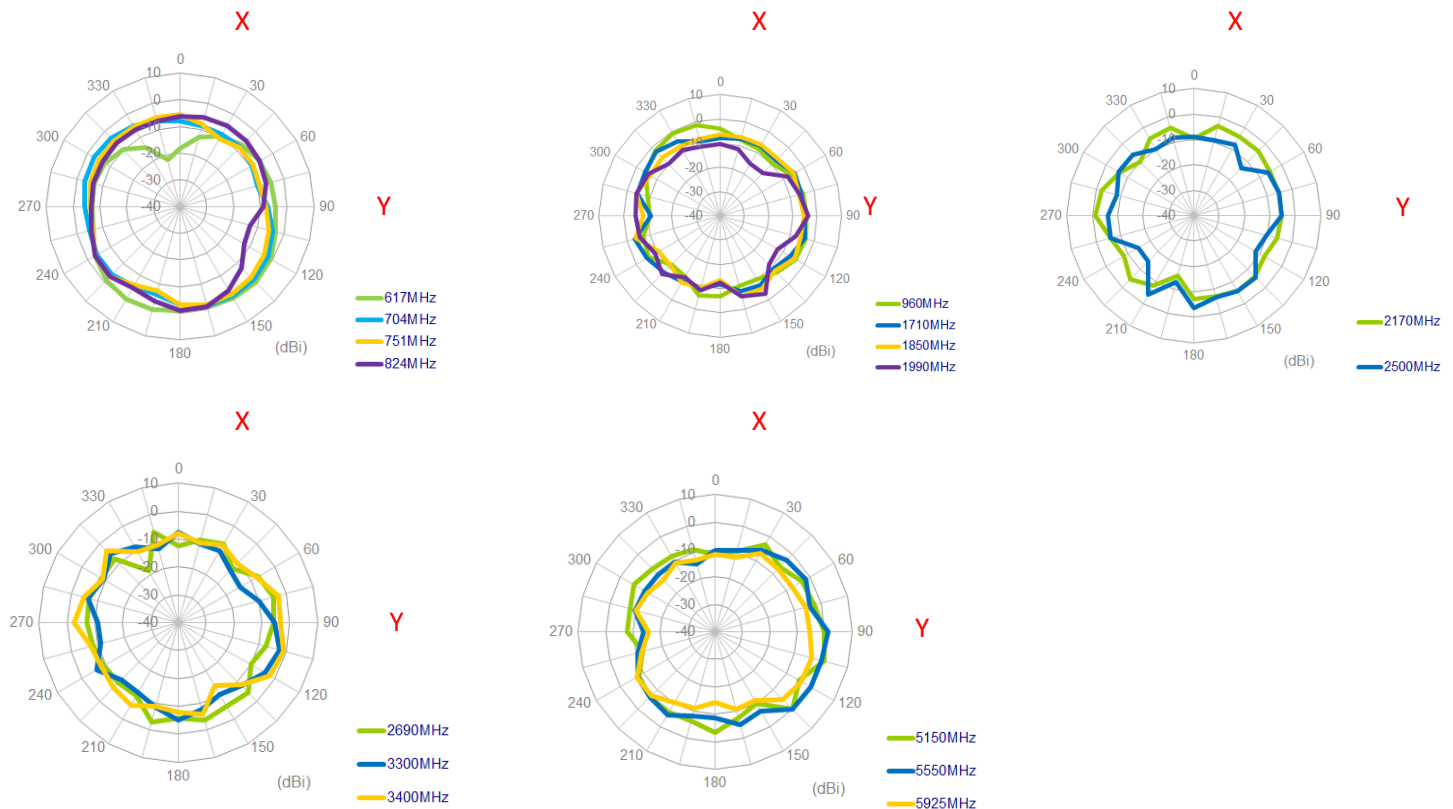

XZ Plane

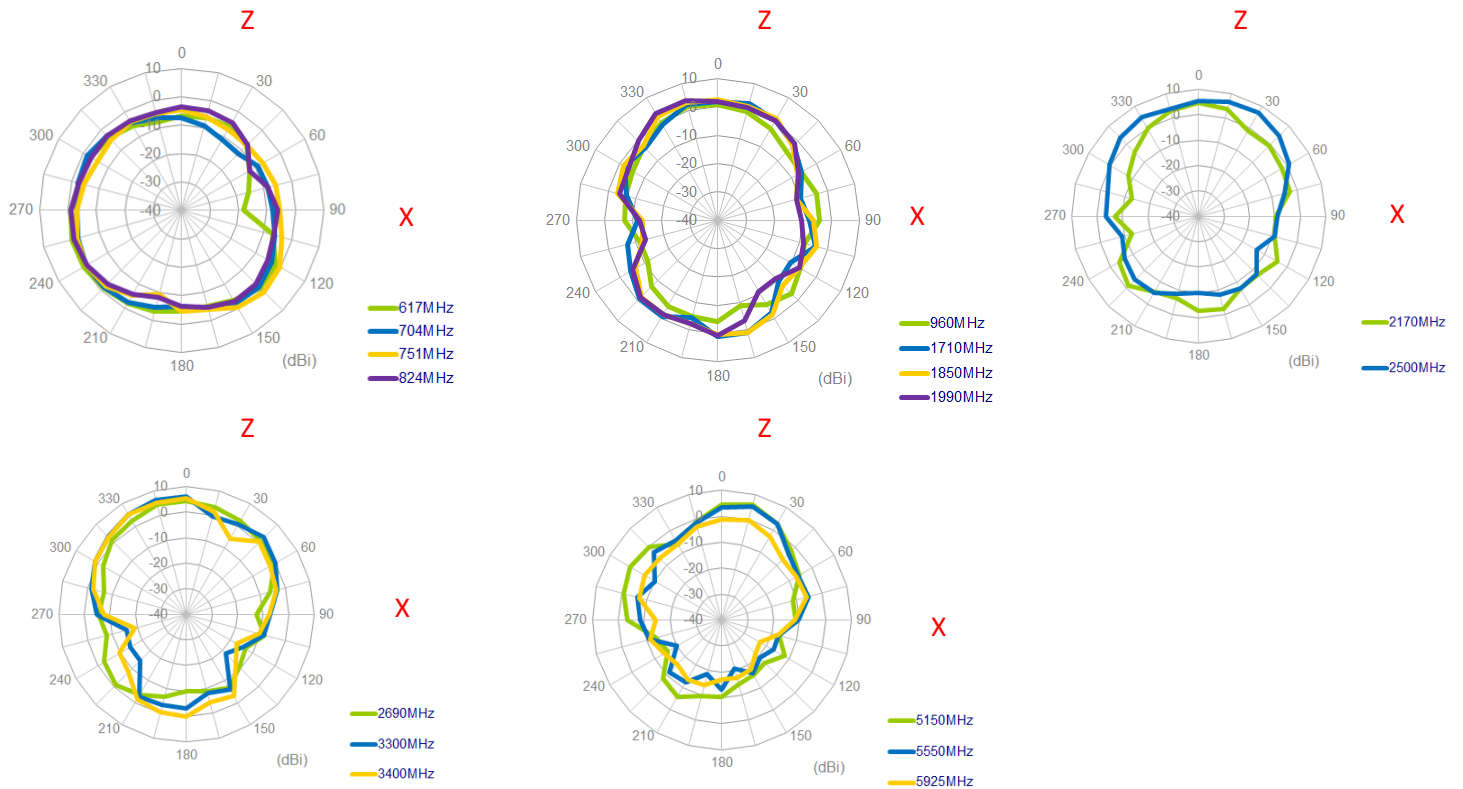

YZ Plane

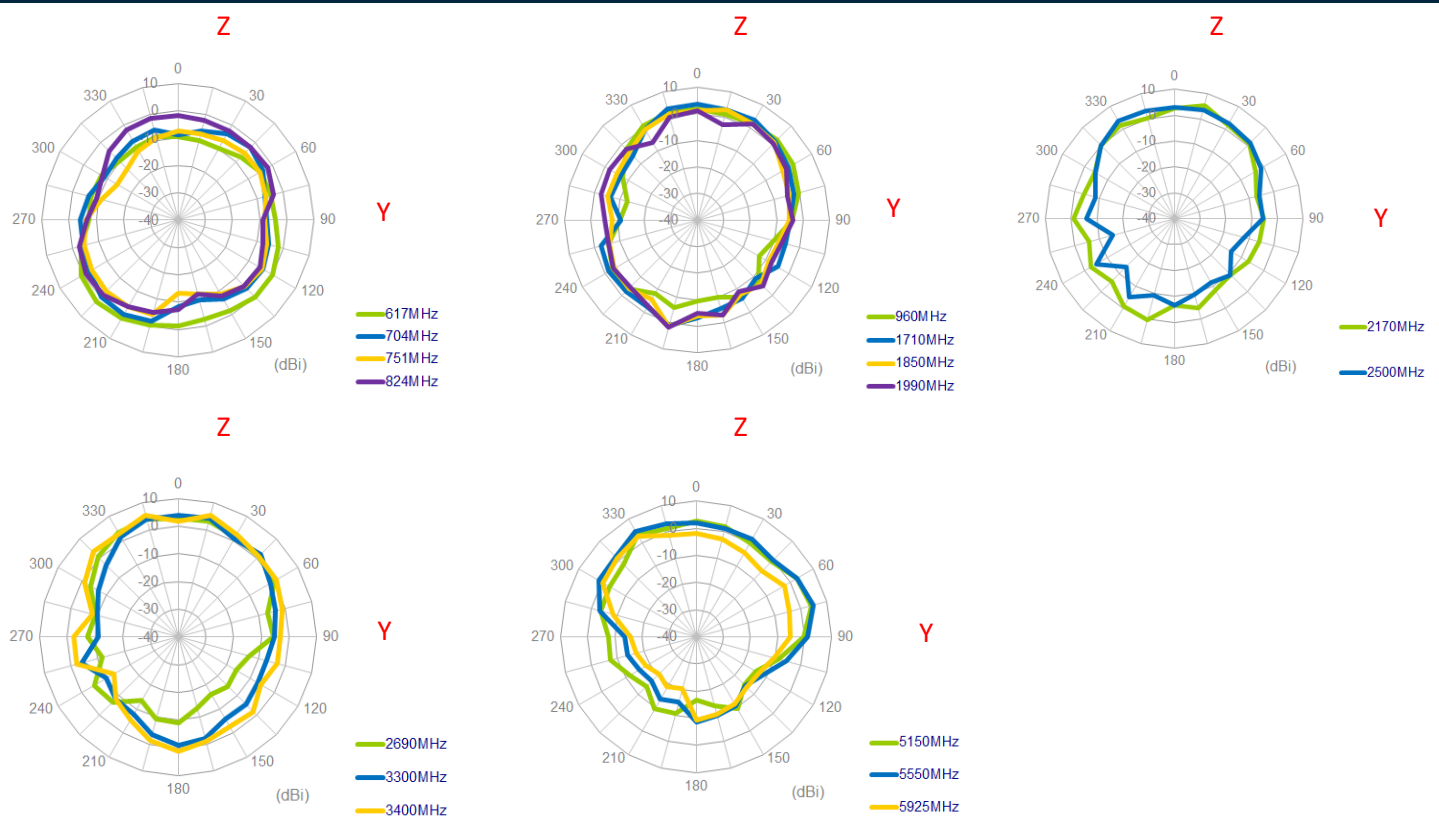

4.2.8 Wi-Fi 1 Antenna-30x30cm Ground

XY Plane

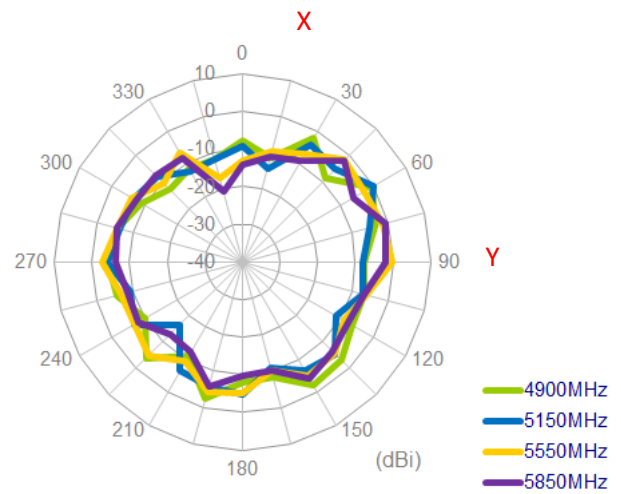
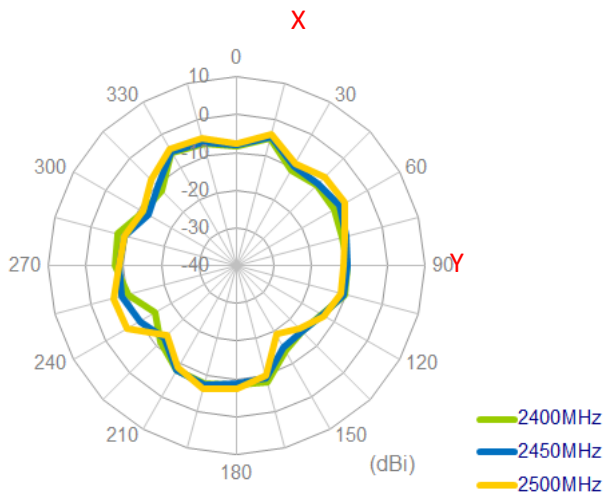

XZ Plane

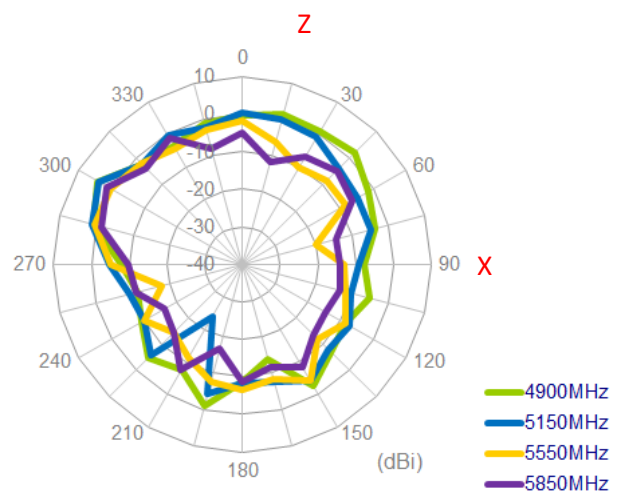
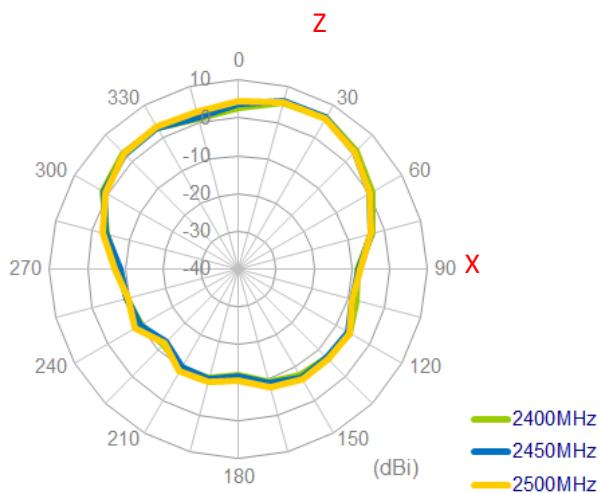

YZ Plane

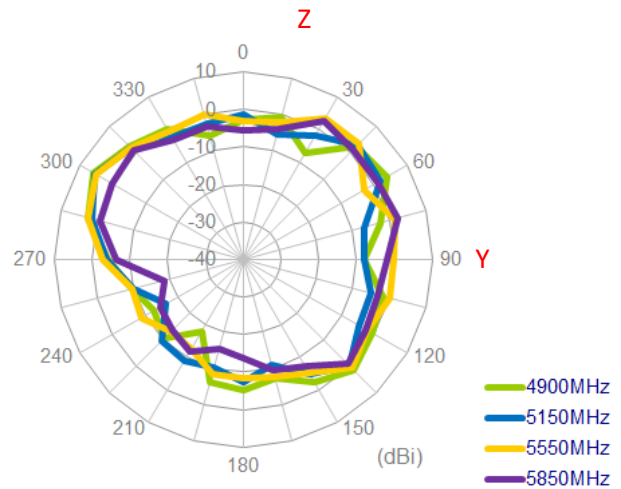
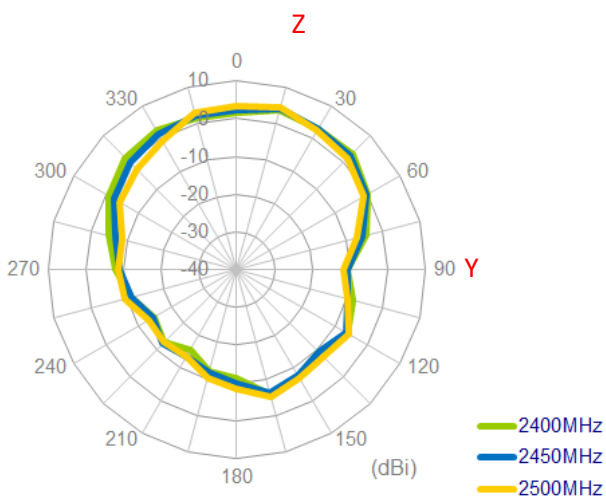

4.2.9 Wi-Fi 2 Antenna-30x30cm Ground

XY Plane

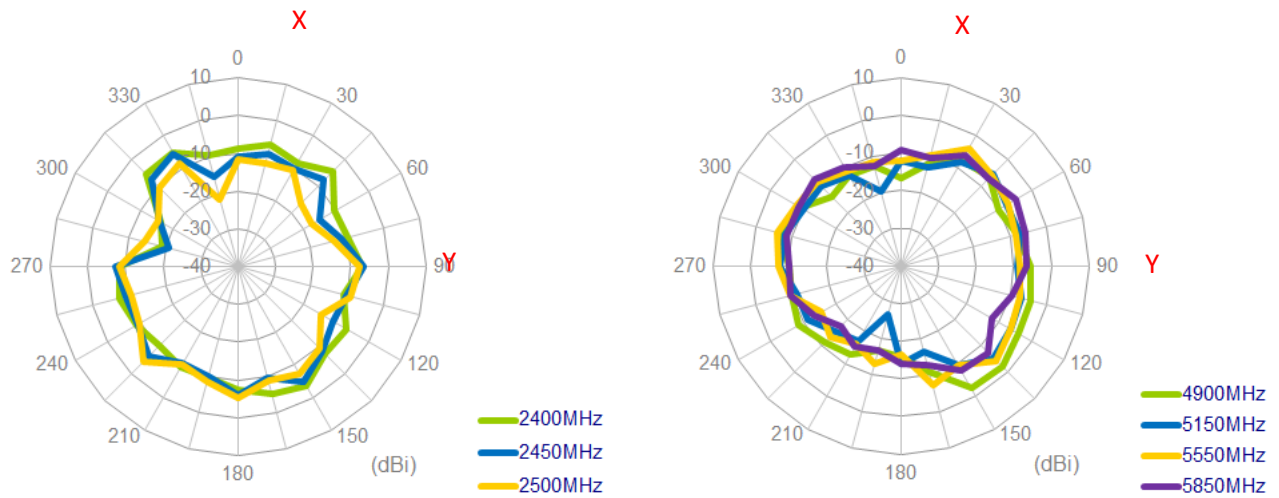

XZ Plane

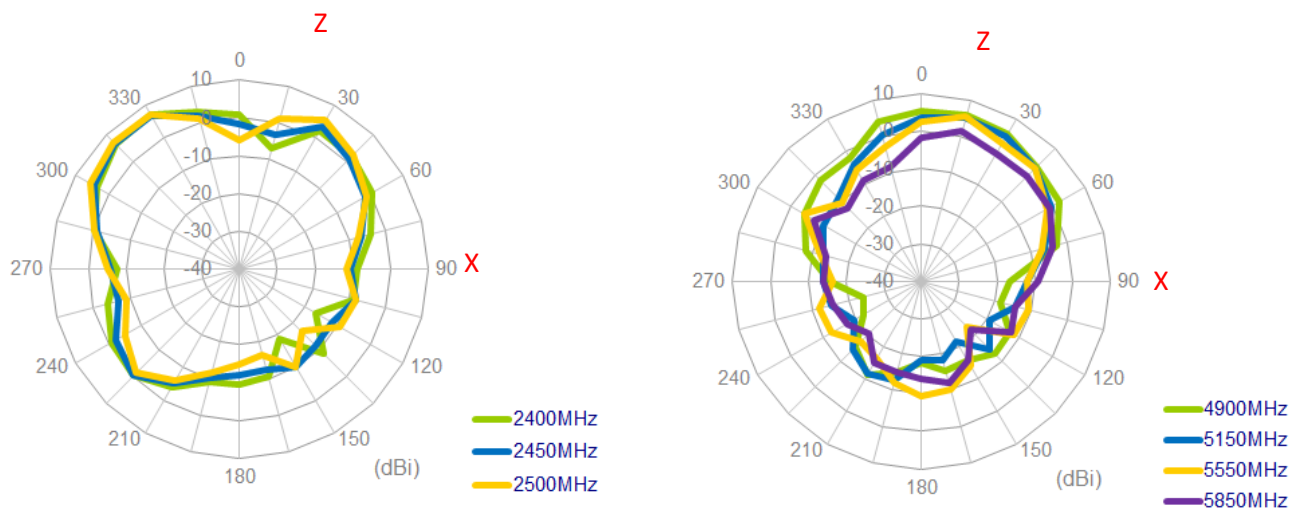

YZ Plane

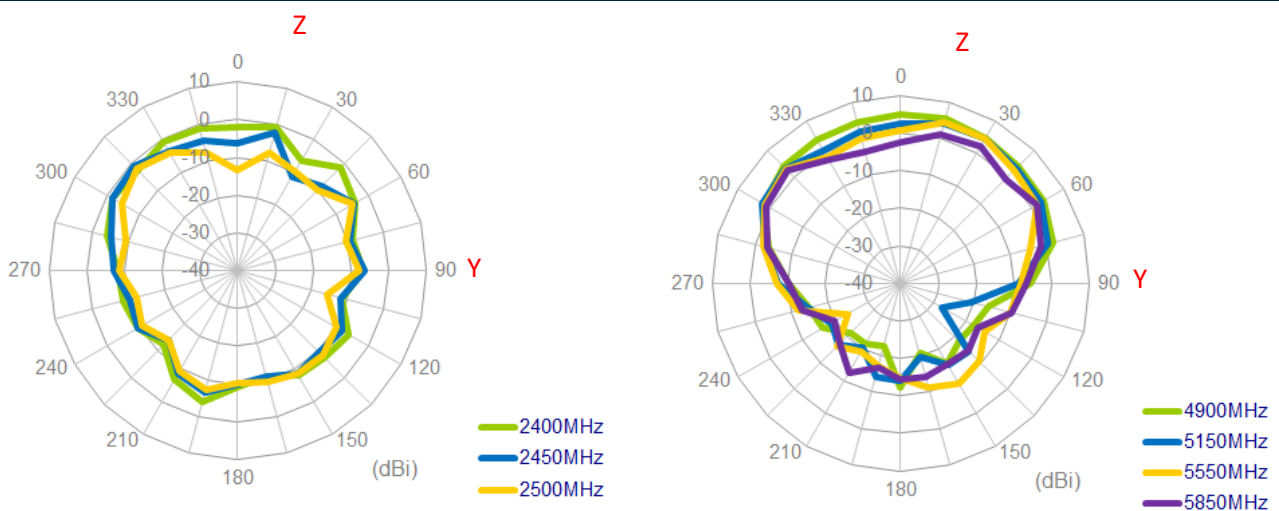

4.2.10 WiFi3 Antenna-30x30cm Ground

XY Plane

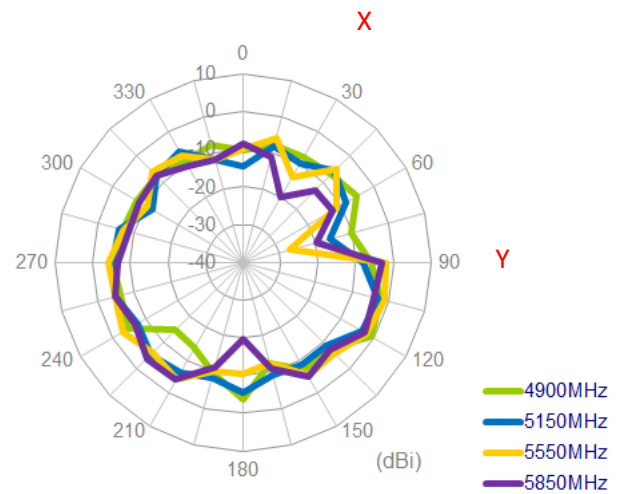
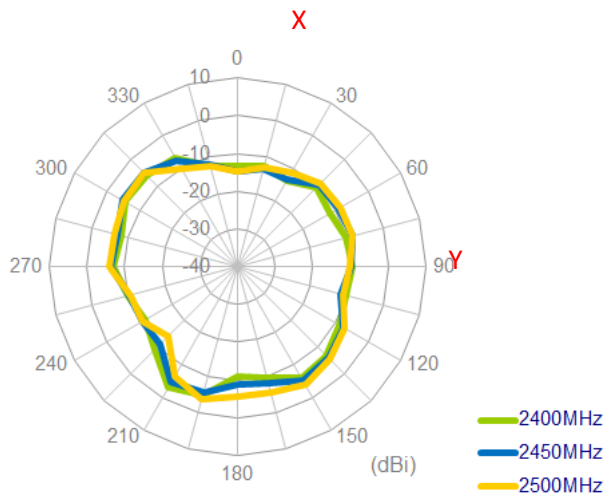

XZ Plane

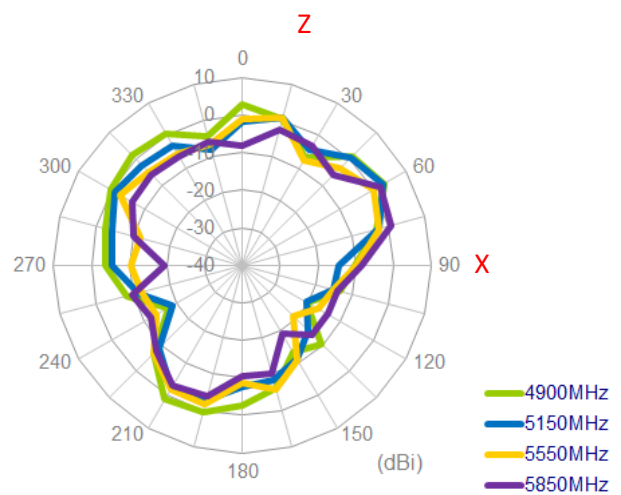
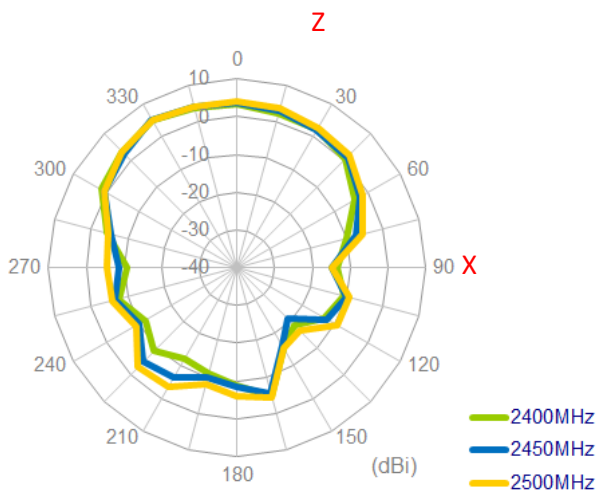

YZ Plane

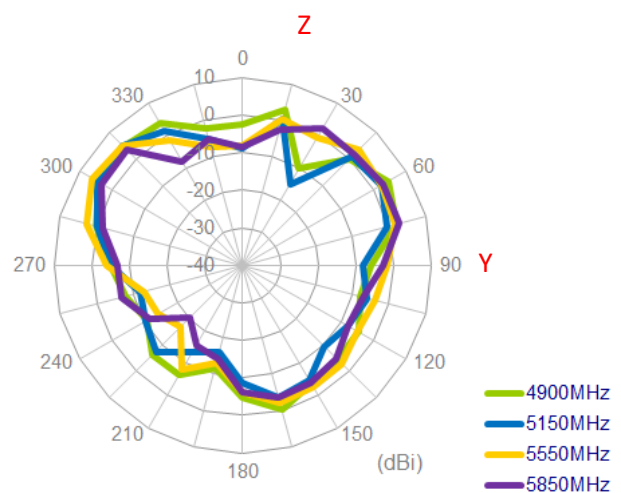
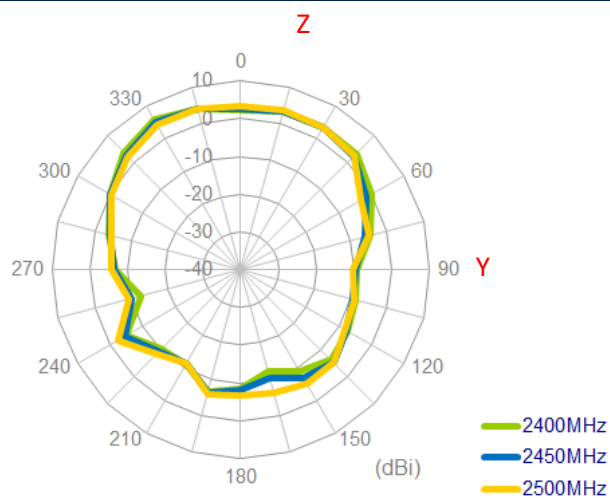

GNSS Antenna

XY Plane

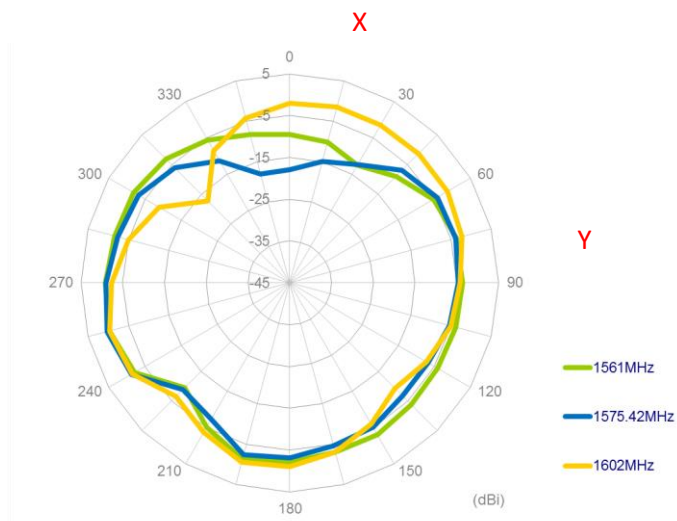

XZ Plane

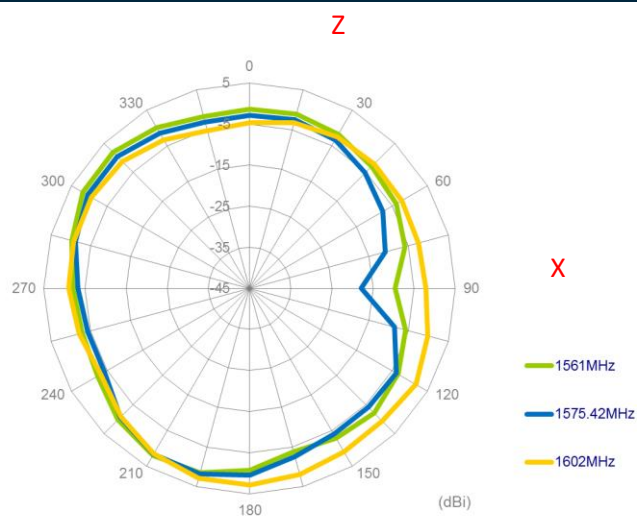

YZ Plane

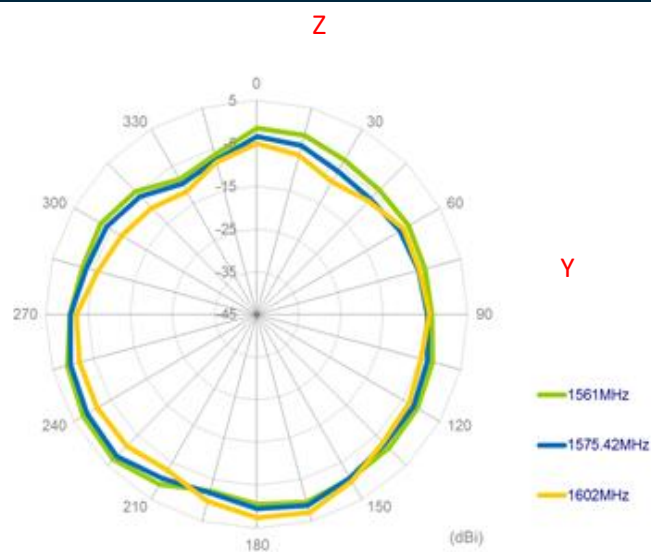

5. Mechanical Drawing (Units: mm)

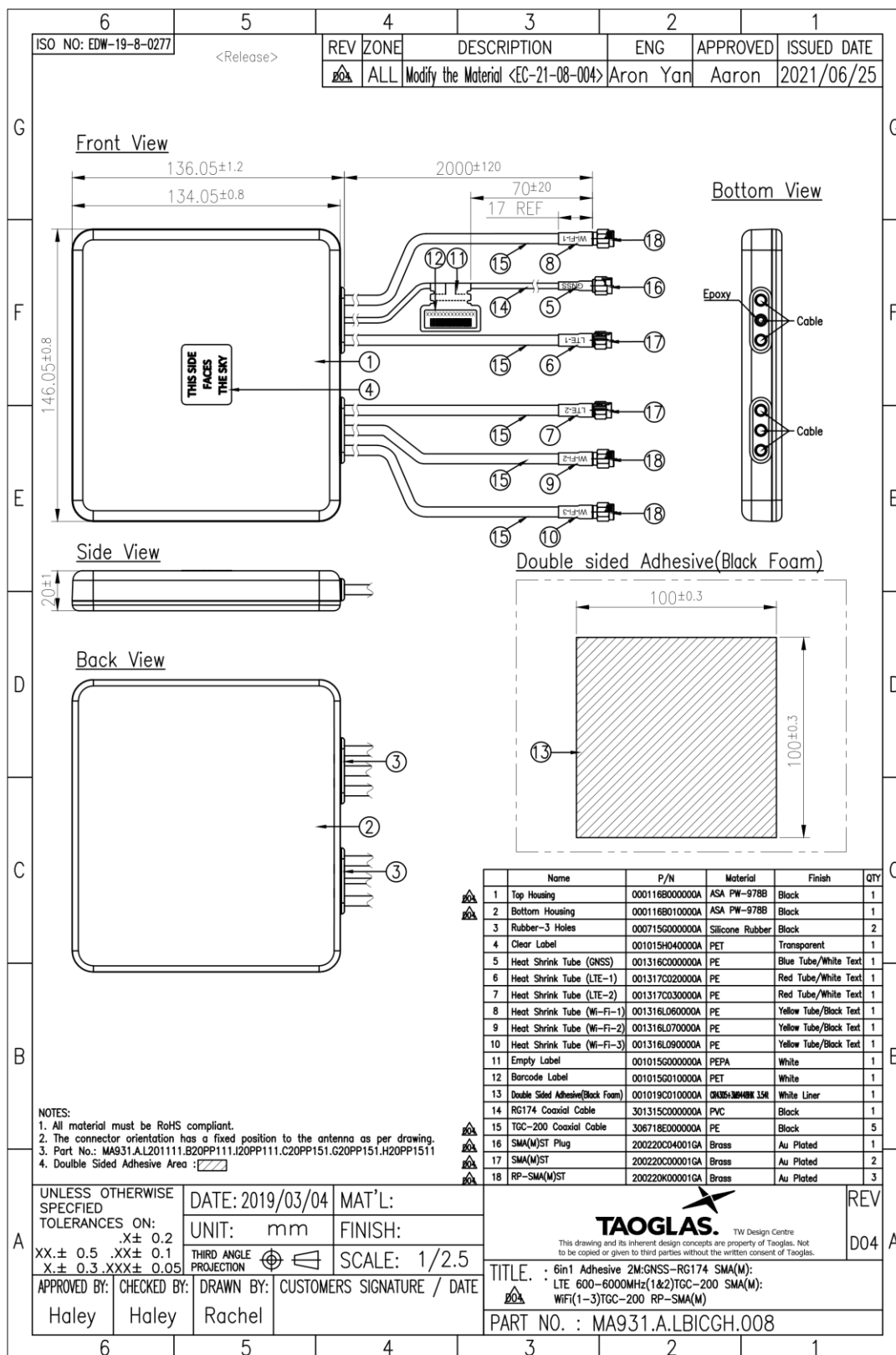

6. Packaging

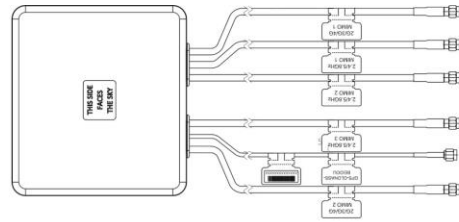

1 No. MA931.A.LBICGH.008 per small box
 Box Dimensions - 260*235*105mm
 Weight - 1.16Kg

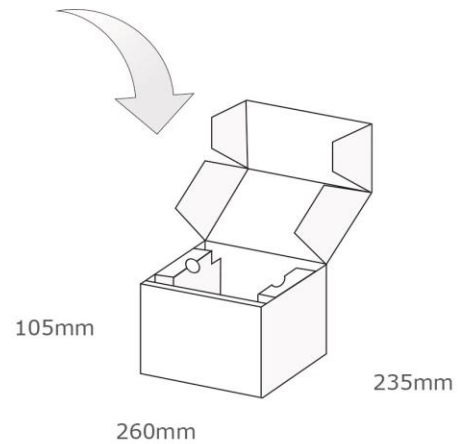

1 Outer Carton
 Carton Dimensions - 540*490*240mm
 8 pcs MA931.A.LBICGH.008 per carton
 Weight - 9.9Kg

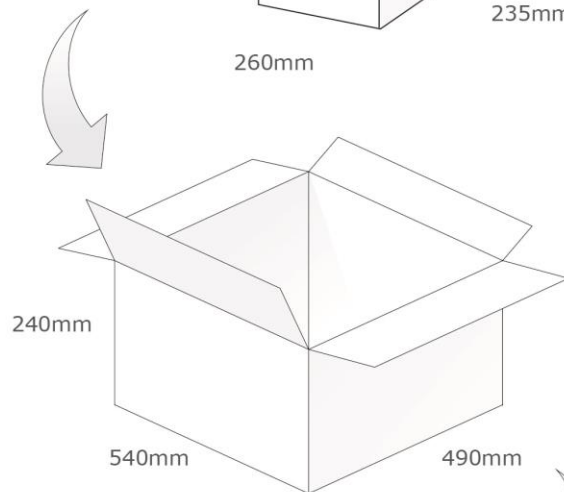

Pallet Dimensions 1200*1000*1400mm
 20 Cartons per Pallet
 4 Cartons per layer
 5 Layers

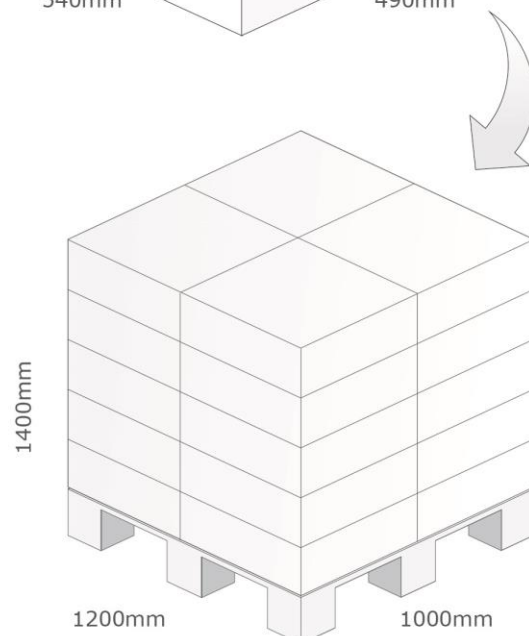

Changelog for the datasheet

SPE-19-8-055 – MA931.A.LBICGH.008

Revision: D	
Date:	2022-07-04
Changes:	Updated Drawing
Changes Made by:	Cesar Sousa

Previous Revisions

Revision: C (Current Version)	
Date:	2020-05-15
Changes:	Updated GNSS Data
Changes Made by:	Jack Conroy

Revision: B	
Date:	2019-11-20
Changes:	Updated Drawing
Changes Made by:	Yu Kai Yeung

Revision: A (Original First Release)	
Date:	2019-04-19
Notes:	
Author:	Jack Conroy



TAOGLAS®

www.taoglas.com

