



TAOGLAS®



Datasheet

Guardian 5in1 Wall Mount Antenna

Part No:
MA950.A.LBICG.005.wm

Description:
Guardian 5in1 Wall Mount Antenna, LTE*2+Wi-Fi*2+GNSS

Features:

- Low-profile Housing – Mounts flush to Surface
- 2* 4G/LTE MIMO 698-4000MHz
- 2* Wi-Fi MIMO 2.4GHz/5.8GHz
- 1* Active GPS-GLONASS-GALILEO-BeiDou Antenna
- Worldwide 4G Bands including 3G and 2G
- IP67 Waterproof Enclosure
- Dims: 146*134*20mm
- 1M Low Loss TGC-200 and RG174 with SMA(M)/RP-SMA(M) connectors
- Cables and Connectors Customizable
- RoHS & REACH Compliant
- Also available in white

1.	Introduction	3
2.	Specifications	4
3.	Antenna Characteristics	10
4.	Mechanical Drawing	93
5.	Packaging	94
6.	Application Note	95
7.	Installation Instructions	141
	Changelog	

Taoglas makes no warranties based on the accuracy or completeness of the contents of this document and reserves the right to make changes to specifications and product descriptions at any time without notice. Taoglas reserves all rights to this document and the information contained herein.

Reproduction, use or disclosure to third parties without express permission is strictly prohibited.



1. Introduction



The MA950 Guardian is a next generation combination antenna. The first panel antenna worldwide designed for IoT Gateway and Router devices. It is a low profile 5in1 wall and adhesive mount antenna. This heavy-duty, fully IP67 waterproof external M2M antenna can be used by RF professionals in IoT Gateway and Routers, HD Video Streaming, Transportation and Remote Monitoring Applications.

This antenna delivers powerful MIMO antenna technology for worldwide 4G LTE bands at 698-4000MHz bands, dual-band 2.4/5.8GHz Wi-Fi, plus GPS-GLONASS-GALILEO-BeiDou for location accuracy. It enables designers to cover a wide range of technologies by installing a single antenna.

4G wireless applications demand high-speed data uplink and downlink. High efficiency and high gain MIMO antennas are necessary to achieve the required signal to noise ratio and throughput required to solve these challenges. Taoglas also takes care to have high isolation among these antennas to prevent self-interference. Low loss cables used to keep efficiency high over long cable lengths. The GPS-GLONASS-GALILEO-BeiDou active antenna has been carefully designed for excellent performance across all GNSS bands, leading to higher location accuracy and stability of tracking in urban environments.

The housing is IP67 waterproof, and the adhesive mount version comes with wall mount bracket. The antenna can be mounted internally or externally on a vehicle. The MA950 comes with 1m, low loss TGC-200 coaxial cables for the LTE and Wi-Fi antennas, and RG174 coaxial cable for the GNSS antenna as standard. Customized cables and connector versions are also available. Contact your regional Taoglas customer support for more information on how to integrate the MA950 or sales support.

2. Specifications

GPS-GLONASS-GALILEO-BeiDou				
Center Frequency	GPS/GALILEO:1575.42±1.023MHz BeiDou:1561.098±2.046MHz GLONASS:1602±5MHz			
Passive Antenna Efficiency (without cable loss)	GPS/GALILEO: 48% GLONASS: 57% BeiDou: 63%			
Passive Antenna Average Gain (without cable loss)	GPS/GALILEO: -3.13dBi GLONASS: -2.39dBi BeiDou: -1.97dBi			
Passive Antenna Peak Gain (without cable loss)	GPS/GALILEO: 1.98dBi GLONASS: 3.01dBi BeiDou: 3dBi			
VSWR	3:1 Max			
Impedance	50Ω			
Axial Ratio	GPS/GALILEO:<14.02 GLONASS:<5.9 BeiDou:<9.7			
Polarization	RHCP			
Cable	1 meter RG174 standard, fully customizable			
Connector	SMA(M) standard, fully customizable			
LNA and Filter Electrical Properties				
Center Frequency	GPS/GALILEO:1575.42±1.023MHz GLONASS:1602±5MHz BeiDou: 1561.098±2.046MHz			
Output Impedance	50Ω			
VSWR	< 2:1			
Return Loss	10dB Min.			
LNA Gain, Current Draw, and Noise Figure@GPS	Voltage	LNA Gain(Typ)	Current Draw(mA) Typ	Noise Figure(Typ)
	Min 1.8V	28dB	7.9mA	1.13dB
	Typ 3.0V	30dB	9.0mA	1.13dB
	Max 5.5V	33dB	9.9mA	1.14dB
Total Specification (Through Antenna, SAW Filter, and LNA)				
Frequency	1561.098±2.046MHz	1575.42±1.023MHz	1602±5MHz	
Gain@3V	1561MHz:28±3dBi	1575.42MHz:28±3dBi	1602MHz:28±3dBi	
Output Impedance	50Ω			

4G/3G/2G LTE Antenna									
Frequency (MHz)	LTE700	GSM850	GSM900	DCS	PCS	UMTS1	LTE2600	LTE3500	
	698~803	824~894	880~960	1710 ~1880	1850 ~1990	1920 ~2170	2490 ~2690	3300 ~3600	
Efficiency (%)									
MIMO_1	Free space	50.82	55.85	41.29	66.47	70.19	71.51	49.20	50.92
	ABS	68.31	69.61	61.27	66.31	70.86	70.00	50.61	51.88
	Glass	67.99	67.37	62.94	66.89	71.80	69.58	51.00	52.83
	Metal	42.12	51.55	58.33	39.49	47.20	47.71	44.36	44.85
	Wall	67.97	70.42	66.80	63.91	64.94	63.35	50.37	51.49
MIMO_2	Free space	54.13	58.97	48.65	61.54	68.31	68.39	54.62	52.55
	ABS	71.74	66.05	58.58	63.18	69.29	69.23	53.95	54.95
	Glass	64.53	55.70	45.22	64.94	67.87	65.86	50.05	51.77
	Metal	55.62	63.13	56.59	32.14	40.89	43.97	54.22	52.90
	Wall	61.91	48.38	52.88	58.00	56.47	56.36	54.68	48.72
Average Gain (dBi)									
MIMO_1	Free space	-2.96	-2.62	-3.85	-1.78	-1.54	-1.46	-3.12	-2.96
	ABS	-1.68	-1.59	-2.13	-1.79	-1.50	-1.55	-3.00	-2.87
	Glass	-1.73	-1.73	-2.02	-1.75	-1.44	-1.58	-2.96	-2.79
	Metal	-3.94	-2.88	-2.37	-4.07	-3.27	-3.23	-3.57	-3.51
	Wall	-1.70	-1.53	-1.76	-1.95	-1.88	-1.99	-3.00	-2.89
MIMO_2	Free space	-2.72	-2.32	-3.17	-2.11	-1.66	-1.66	-2.65	-2.83
	ABS	-1.47	-1.81	-2.33	-2.00	-1.59	-1.60	-2.71	-2.63
	Glass	-1.93	-2.56	-3.46	-1.88	-1.68	-1.82	-3.04	-2.87
	Metal	-2.61	-2.00	-2.50	-4.95	-3.90	-3.59	-2.67	-2.77
	Wall	-2.09	-3.15	-2.79	-2.37	-2.48	-2.50	-2.63	-3.15
Peak Gain (dBi)									
MIMO_1	Free space	3.18	3.60	2.14	3.98	4.37	4.37	3.70	4.49
	ABS	4.65	4.00	3.45	5.24	6.05	6.05	4.69	3.18
	Glass	3.71	3.92	4.35	5.28	6.16	7.67	5.34	3.87
	Metal	5.09	3.10	4.73	4.50	4.96	5.69	6.02	4.96
	Wall	4.74	4.97	3.67	5.44	4.84	4.84	5.08	3.75
MIMO_2	Free space	5.83	3.66	2.57	3.78	4.01	4.01	3.87	3.97
	ABS	4.33	4.52	4.41	4.34	4.73	5.69	5.64	5.42
	Glass	3.02	3.14	1.36	4.99	5.89	6.02	6.18	4.42
	Metal	3.54	3.11	3.33	3.12	4.36	5.02	7.16	4.95
	Wall	3.21	1.77	2.15	5.49	5.49	7.20	6.10	4.74
Impedance			50Ω						
Polarization			Linear						
VSWR			< 3						
Cable			1 meter TGC-200 standard, fully customizable						
Connector			SMA(M) standard, fully customizable						

2.4GHz/5.8GHz Wi-Fi Antenna			
Frequency (MHz)		2400~2500	4900~5850
Efficiency (%)			
MIMO_1	Free space	57.73	48.06
	ABS	53.59	49.42
	Glass	53.98	47.16
	Metal	51.80	46.70
	Wall	61.02	46.29
MIMO_2	Free space	44.09	47.04
	ABS	46.34	46.79
	Glass	40.79	46.88
	Metal	45.58	45.59
	Wall	50.62	43.60
Average Gain (dBi)			
MIMO_1	Free space	-2.39	-3.25
	ABS	-2.71	-3.13
	Glass	-2.68	-3.36
	Metal	-2.86	-3.44
	Wall	-2.15	-3.42
MIMO_2	Free space	-3.57	-3.33
	ABS	-3.37	-3.36
	Glass	-3.91	-3.35
	Metal	-3.45	-3.52
	Wall	-2.96	-3.67
Peak Gain (dBi)			
MIMO_1	Free space	4.35	4.84
	ABS	5.34	5.18
	Glass	2.99	5.03
	Metal	5.22	5.98
	Wall	5.47	5.77
MIMO_2	Free space	2.94	5.70
	ABS	2.18	5.43
	Glass	3.75	7.07
	Metal	6.02	6.76
	Wall	3.23	5.97
Impedance	50Ω		
Polarization	Linear		
VSWR	< 3		
Cable	1 meter TGC-200 standard, fully customizable		
Connector	RP-SMA(M) standard, fully customizable		

MECHANICAL	
Antenna Dimensions	146*134*20mm
Casing	ASA
Weight (including cable)	640g
Ingress Protection Rating	IP67
ENVIRONMENTAL	
Operation Temperature	-40°C to 85°C
Storage Temperature	-40°C to 90°C
Humidity	Non-condensing 65°C 95% RH

2.1. LTE Bands Covered while on metal Ground Plane

LTE Bands				
Band Number	LTE / LTE-Advanced / WCDMA / HSPA / HSPA+ / TD-SCDMA			
	Uplink	Downlink	MIMO 1	MIMO 2
1	UL: 1920 to 1980	DL: 2110 to 2170	✓	✓
2	UL: 1850 to 1910	DL: 1930 to 1990	✓	✓
3	UL: 1710 to 1785	DL: 1805 to 1880	✓	✓
4	UL: 1710 to 1755	DL: 2110 to 2155	✓	✓
5	UL: 824 to 849	DL: 869 to 894	✓	✓
7	UL: 2500 to 2570	DL: 2620 to 2690	✓	✓
8	UL: 880 to 915	DL: 925 to 960	✓	✓
9	UL: 1749.9 to 1784.9	DL: 1844.9 to 1879.9	✓	✓
11	UL: 1427.9 to 1447.9	DL: 1475.9 to 1495.9	✗	✗
12	UL: 699 to 716	DL: 729 to 746	✓	✓
13	UL: 777 to 787	DL: 746 to 756	✓	✓
14	UL: 788 to 798	DL: 758 to 768	✓	✓
17	UL: 704 to 716	DL: 734 to 746 (LTE only)	✓	✓
18	UL: 815 to 830	DL: 860 to 875 (LTE only)	✓	✓
19	UL: 830 to 845	DL: 875 to 890	✓	✓
20	UL: 832 to 862	DL: 791 to 821	✓	✓
21	UL: 1447.9 to 1462.9	DL: 1495.9 to 1510.9	✗	✗
22	UL: 3410 to 3490	DL: 3510 to 3590	✓	✓
23	UL: 2000 to 2020	DL: 2180 to 2200 (LTE only)	✓	✓
24	UL: 1625.5 to 1660.5	DL: 1525 to 1559 (LTE only)	✓	✗
25	UL: 1850 to 1915	DL: 1930 to 1995	✓	✓
26	UL: 814 to 849	DL: 859 to 894	✓	✓
27	UL: 807 to 824	DL: 852 to 869 (LTE only)	✓	✓
28	UL: 703 to 748	DL: 758 to 803 (LTE only)	✓	✓
29	UL: -	DL: 717 to 728 (LTE only)	✓	✓
30	UL: 2305 to 2315	DL: 2350 to 2360 (LTE only)	✓	✓
31	UL: 452.5 to 457.5	DL: 462.5 to 467.5 (LTE only)	✗	✗
32	UL: -	DL: 1452 - 1496	✗	✗
35		1850 to 1910	✓	✓
38		2570 to 2620	✓	✓
39		1880 to 1920	✓	✓
40		2300 to 2400	✓	✓
41		2496 to 2690	✓	✓
42		3400 to 3600	✓	✓
43		3600 to 3800	✓	✓

*Covered bands represent greater than 20% efficiency

2.2. LTE Bands Covered in Free Space

LTE Bands				
Band Number	LTE / LTE-Advanced / WCDMA / HSPA / HSPA+ / TD-SCDMA			
	Uplink	Downlink	MIMO 1	MIMO 2
1	UL: 1920 to 1980	DL: 2110 to 2170	✓	✓
2	UL: 1850 to 1910	DL: 1930 to 1990	✓	✓
3	UL: 1710 to 1785	DL: 1805 to 1880	✓	✓
4	UL: 1710 to 1755	DL: 2110 to 2155	✓	✓
5	UL: 824 to 849	DL: 869 to 894	✓	✓
7	UL: 2500 to 2570	DL: 2620 to 2690	✓	✓
8	UL: 880 to 915	DL: 925 to 960	✓	✓
9	UL: 1749.9 to 1784.9	DL: 1844.9 to 1879.9	✓	✓
11	UL: 1427.9 to 1447.9	DL: 1475.9 to 1495.9	✗	✗
12	UL: 699 to 716	DL: 729 to 746	✓	✓
13	UL: 777 to 787	DL: 746 to 756	✓	✓
14	UL: 788 to 798	DL: 758 to 768	✓	✓
17	UL: 704 to 716	DL: 734 to 746 (LTE only)	✓	✓
18	UL: 815 to 830	DL: 860 to 875 (LTE only)	✓	✓
19	UL: 830 to 845	DL: 875 to 890	✓	✓
20	UL: 832 to 862	DL: 791 to 821	✓	✓
21	UL: 1447.9 to 1462.9	DL: 1495.9 to 1510.9	✗	✗
22	UL: 3410 to 3490	DL: 3510 to 3590	✓	✓
23	UL: 2000 to 2020	DL: 2180 to 2200 (LTE only)	✓	✓
24	UL: 1625.5 to 1660.5	DL: 1525 to 1559 (LTE only)	✓	✓
25	UL: 1850 to 1915	DL: 1930 to 1995	✓	✓
26	UL: 814 to 849	DL: 859 to 894	✓	✓
27	UL: 807 to 824	DL: 852 to 869 (LTE only)	✓	✓
28	UL: 703 to 748	DL: 758 to 803 (LTE only)	✓	✓
29	UL: -	DL: 717 to 728 (LTE only)	✓	✓
30	UL: 2305 to 2315	DL: 2350 to 2360 (LTE only)	✓	✓
31	UL: 452.5 to 457.5	DL: 462.5 to 467.5 (LTE only)	✗	✗
32	UL: -	DL: 1452 - 1496	✓	✓
35		1850 to 1910	✓	✓
38		2570 to 2620	✓	✓
39		1880 to 1920	✓	✓
40		2300 to 2400	✓	✓
41		2496 to 2690	✓	✓
42		3400 to 3600	✓	✓
43		3600 to 3800	✓	✓

*Covered bands represent an efficiency greater than 20%

3. Antenna Characteristics

3.1 GPS-GLONASS-GALILEOBeiDou

3.1.1 Block Diagram (Active antenna)

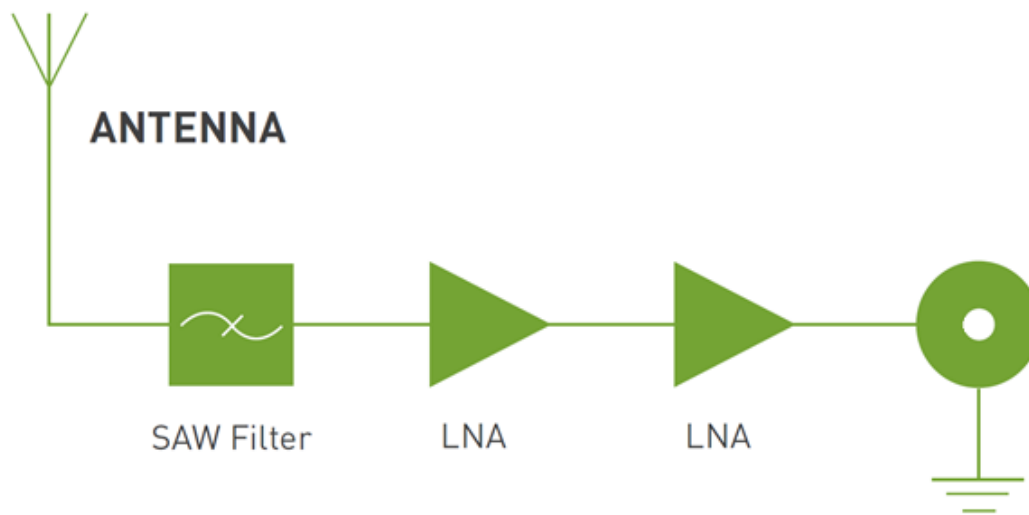

3.1.2 Test Setup



3.1.3 GPS-GLONASS-GALILEO-BeiDou Return Loss (Passive antenna)

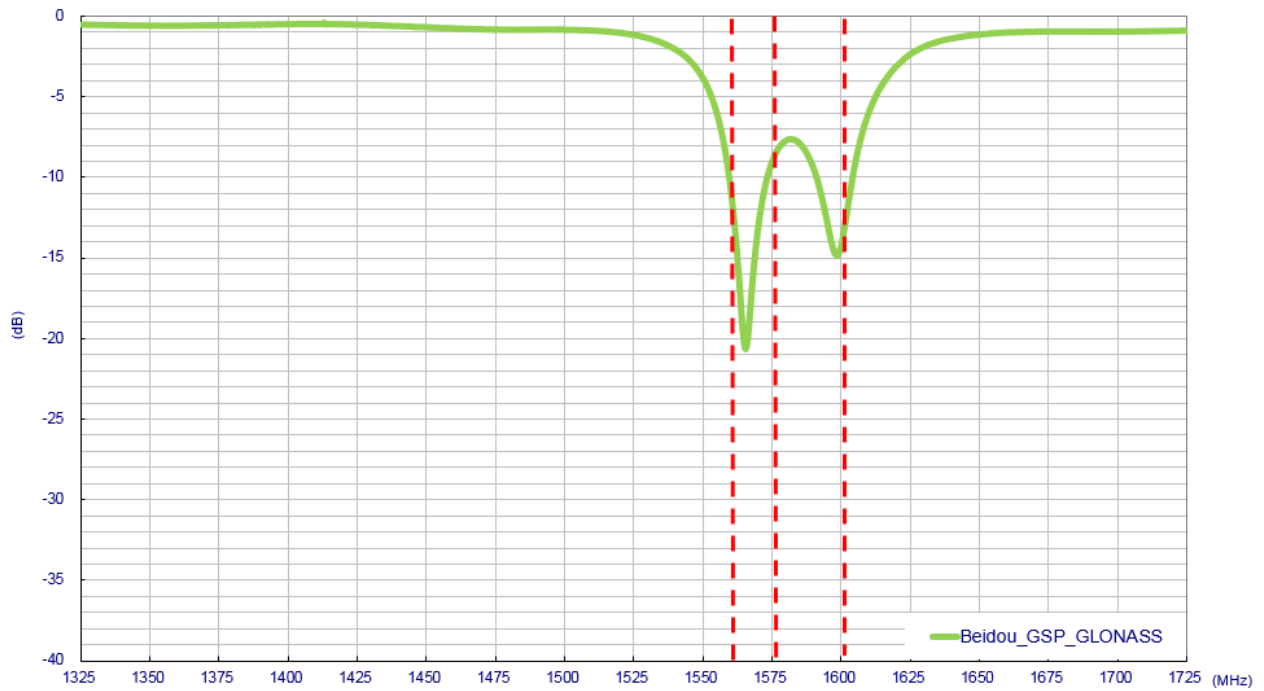

3.1.4 GPS-GLONASS-GALILEO-BeiDou Smith Chart (Passive antenna)

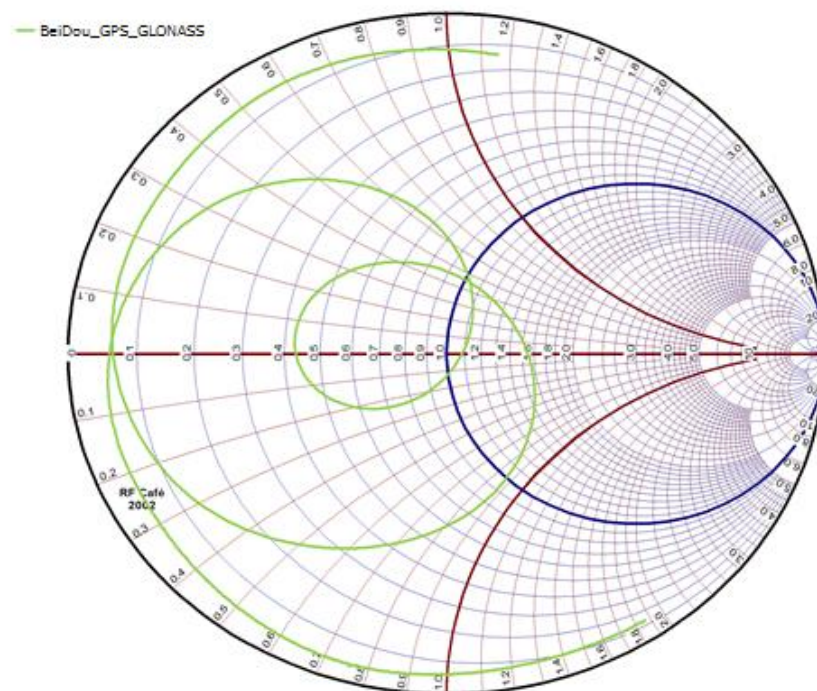

3.1.5 GPS-GLONASS-GALILEO-BeiDou Efficiency (Passive antenna)

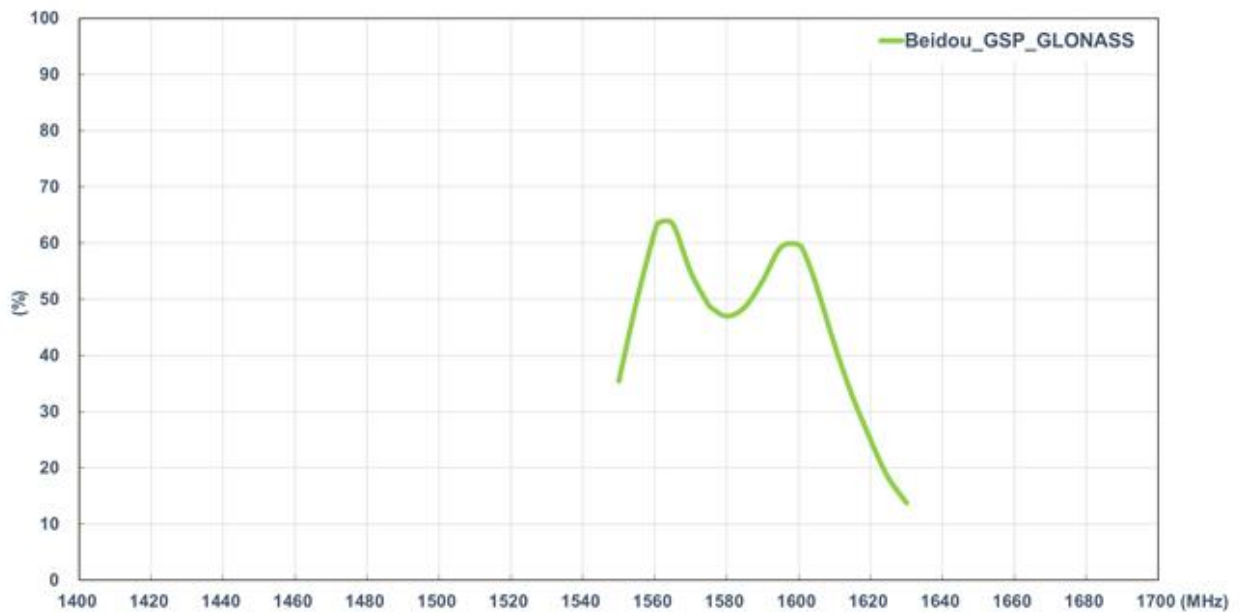

3.1.6 GLONASS-GALILEO-BeiDou Peak Gain (Passive antenna)

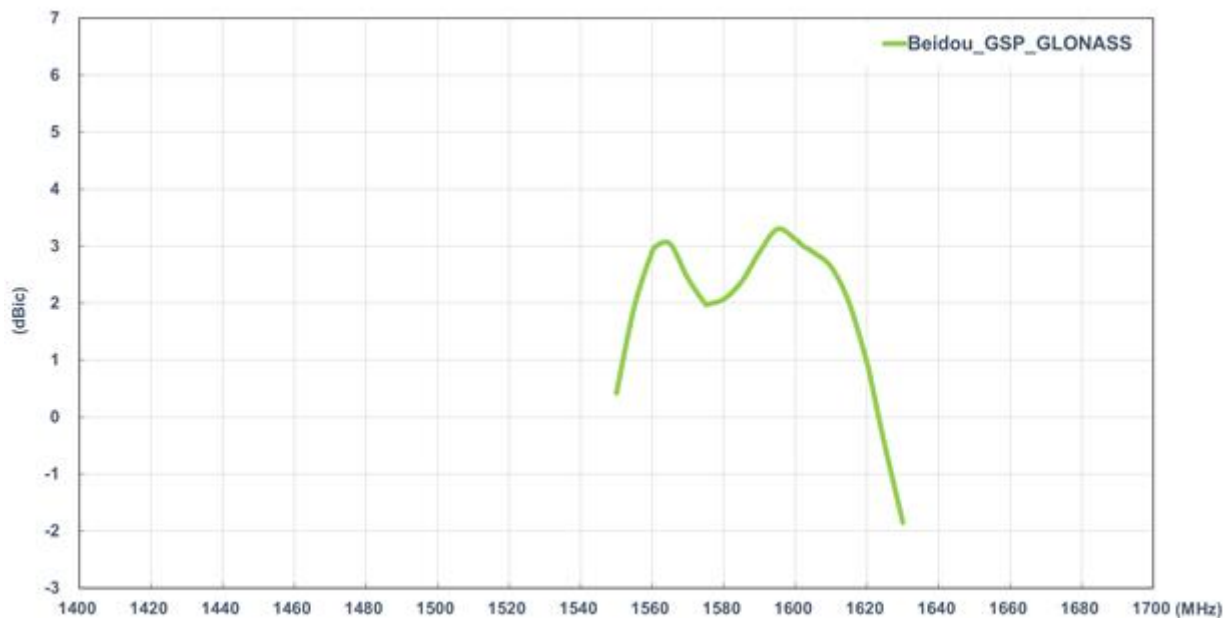

3.1.7 GPS-GLONASS-GAILEO-BeiDou Average Gain (Passive antenna)

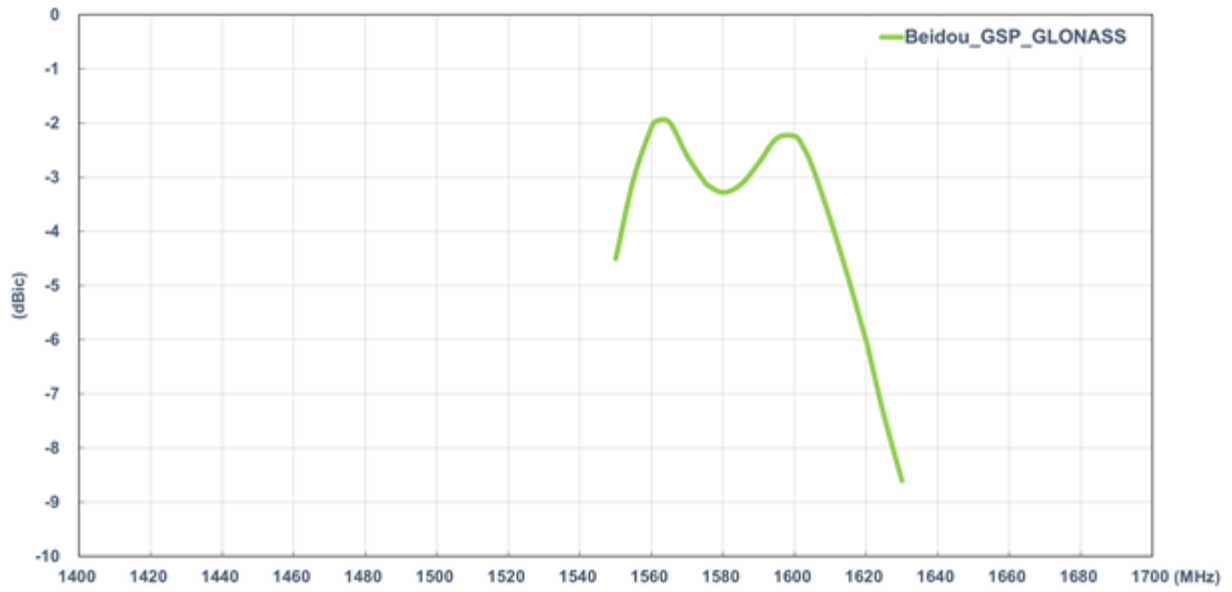

3.1.8 GLONASS-GALILEO-BeiDou Radiation Pattern (Passive antenna)

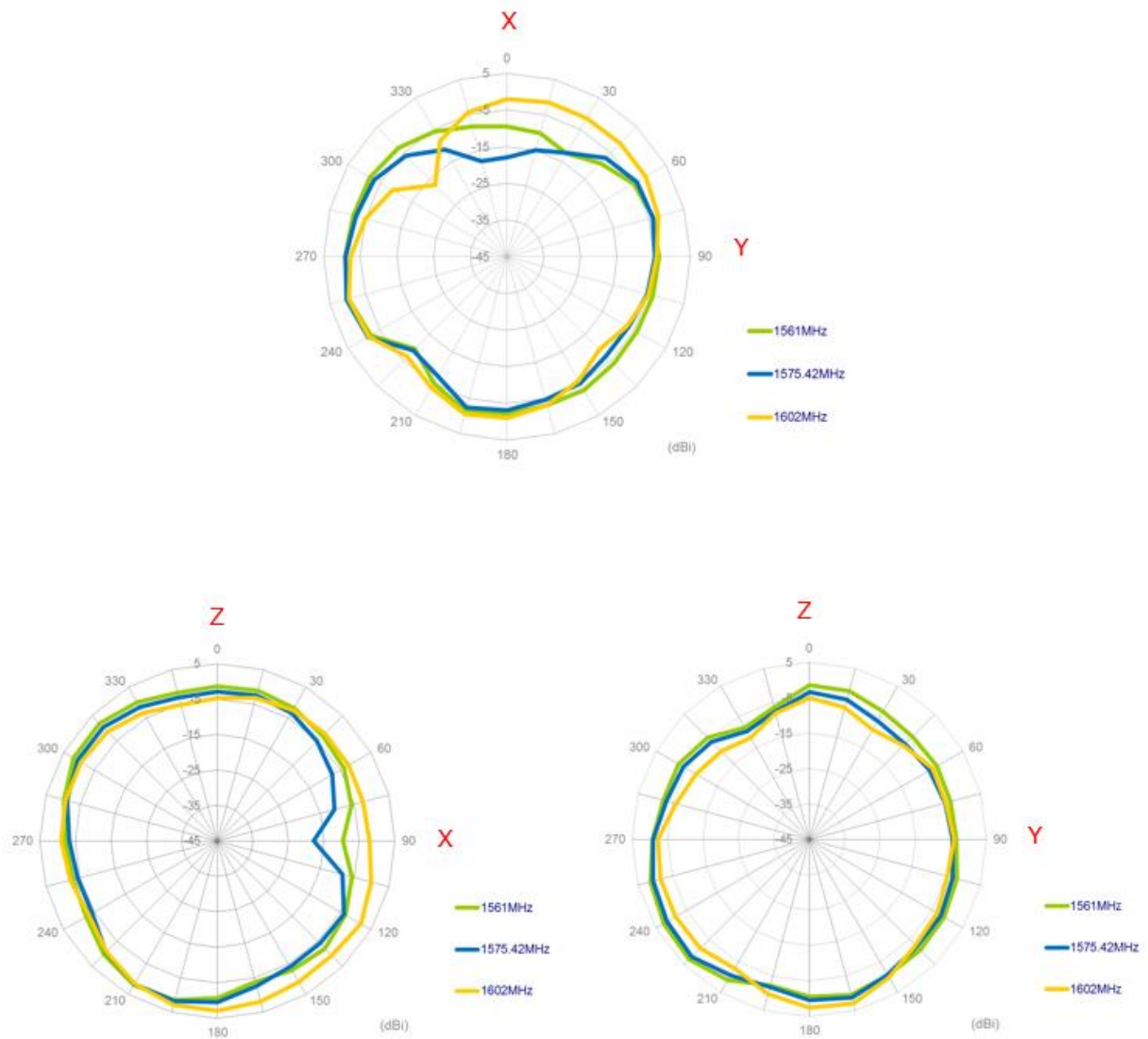

3.1.9 3D Radiation Pattern (Passive antenna)

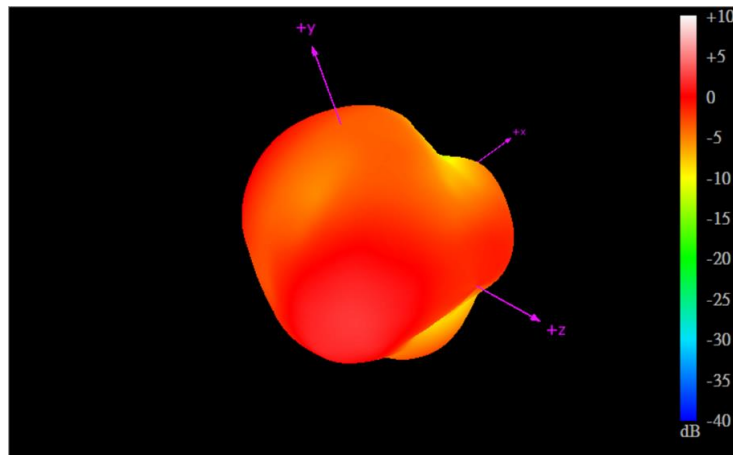

1561MHz

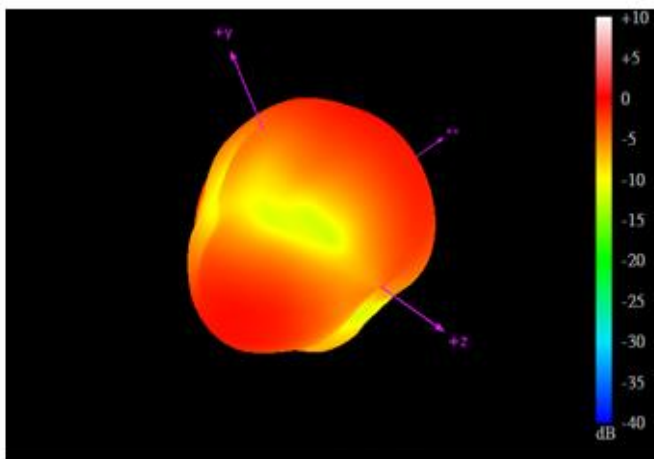

1575.42MHz

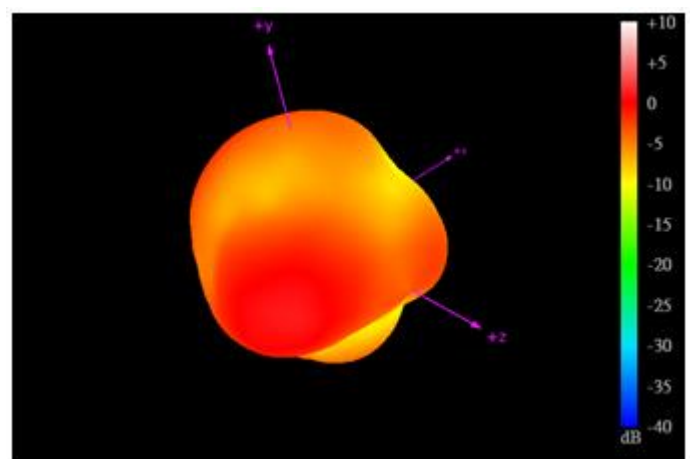

1602MHz

3.1.10 Axial Ratio (Passive antenna)

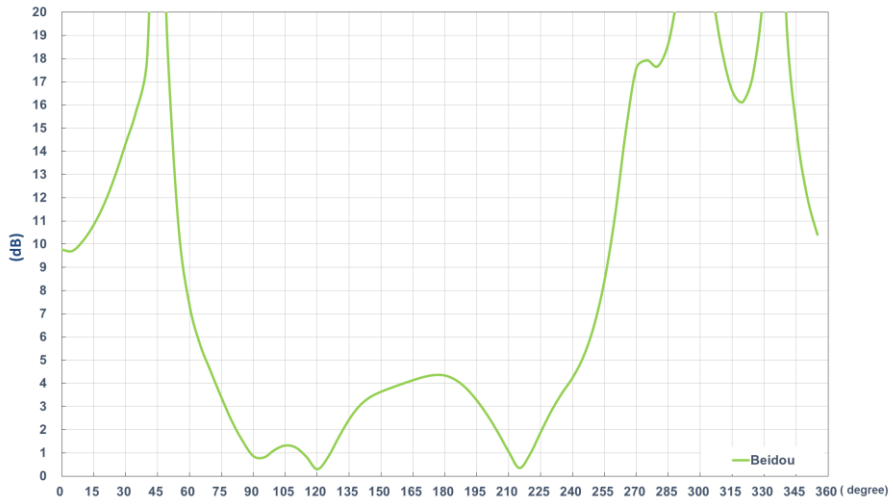

1561MHz

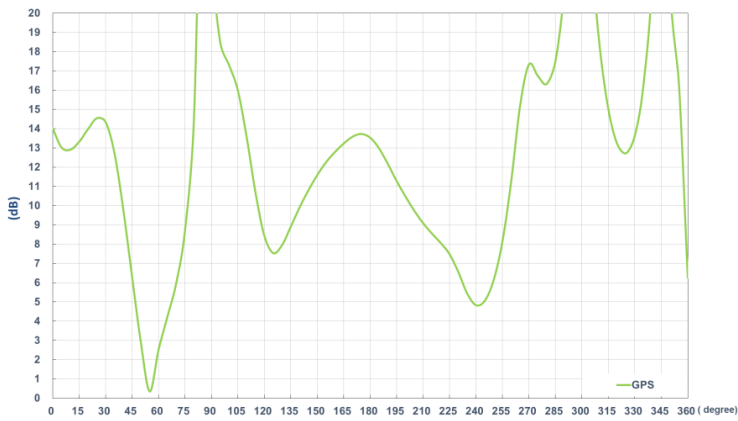

1575.42MHz

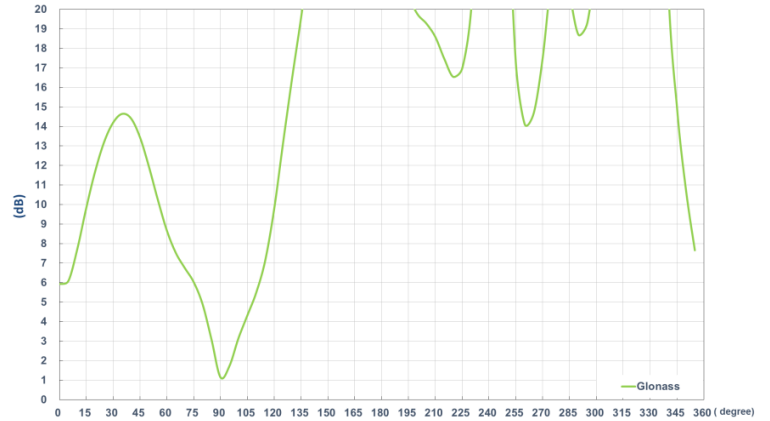

1602MHz

3.1.11 GPS-GLONASS-GALILEO-BeiDou LNA Gain and Noise Figure (Active)

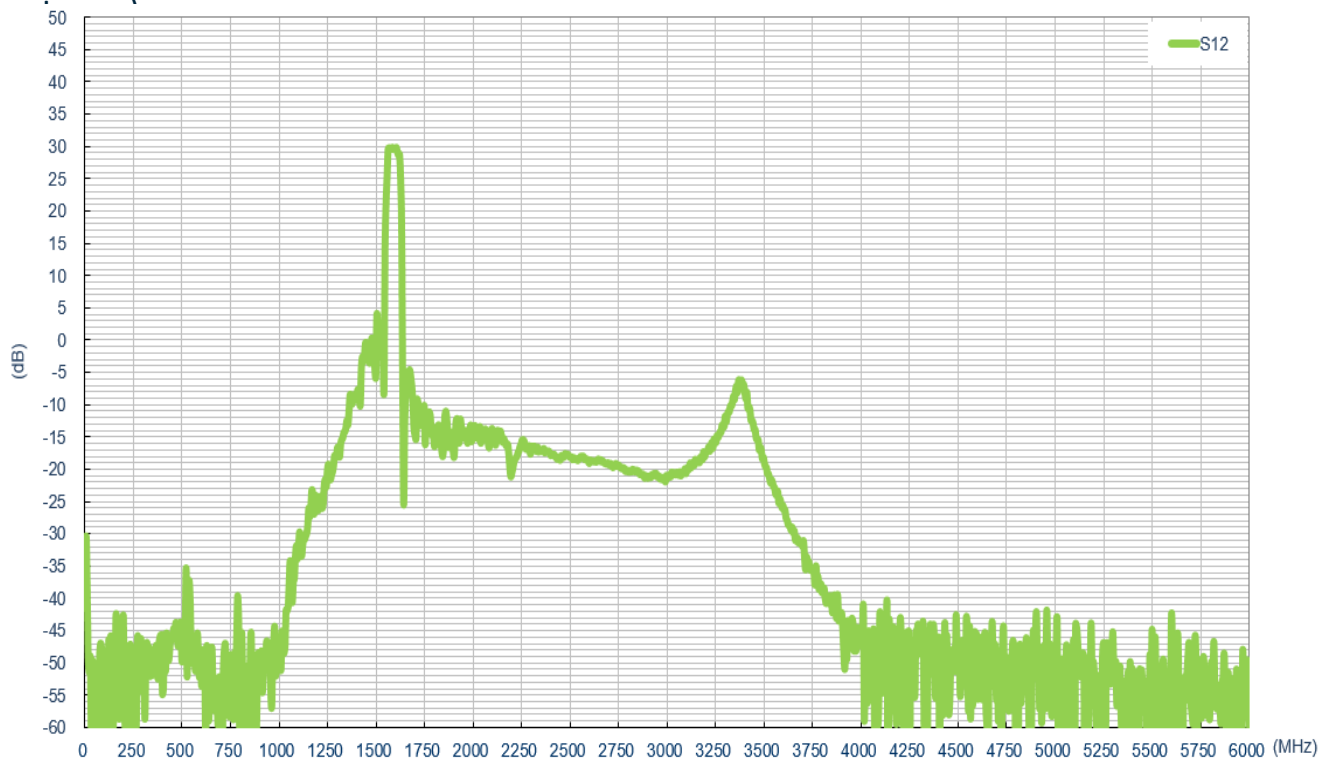

LNA Gain@3.0V

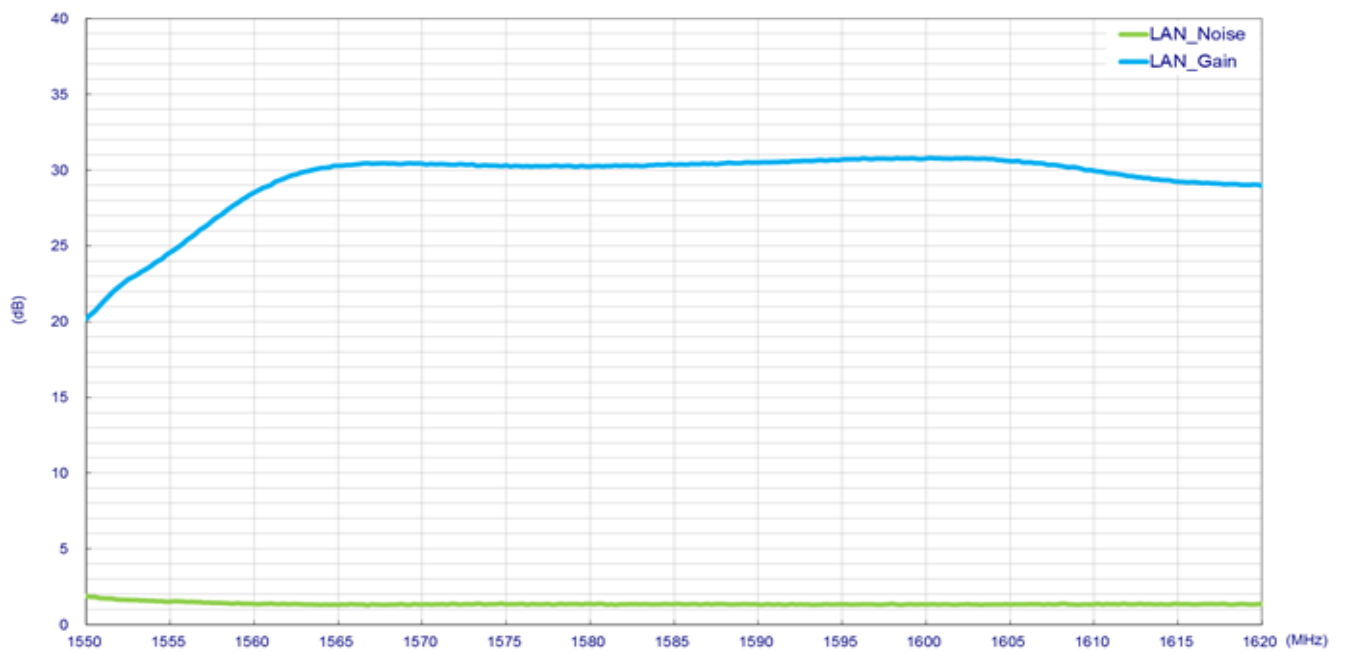

LNA Noise Figure @3.0V

3.2 LTE_MIMO/Wi-Fi_MIMO Antenna

3.2.1 Test Setup

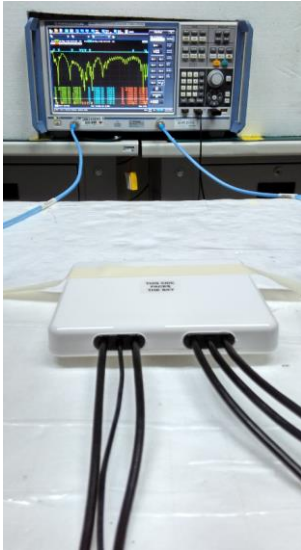

Free space



ABS

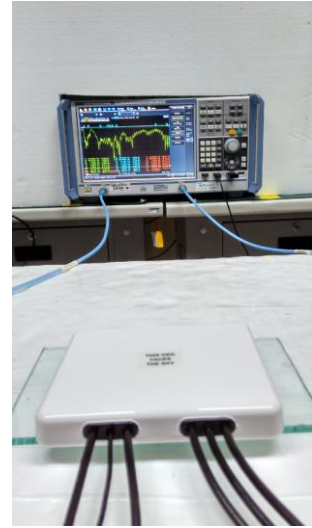

Glass

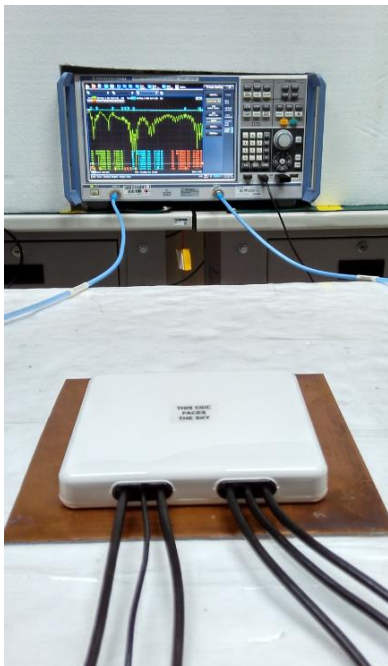

Metal

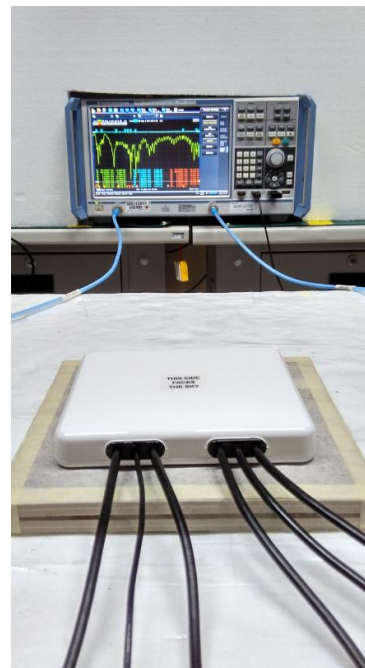

Wall

3.2.2 LTE_1 Antenna Return Loss

Performance in different environments with 1 meter cable length

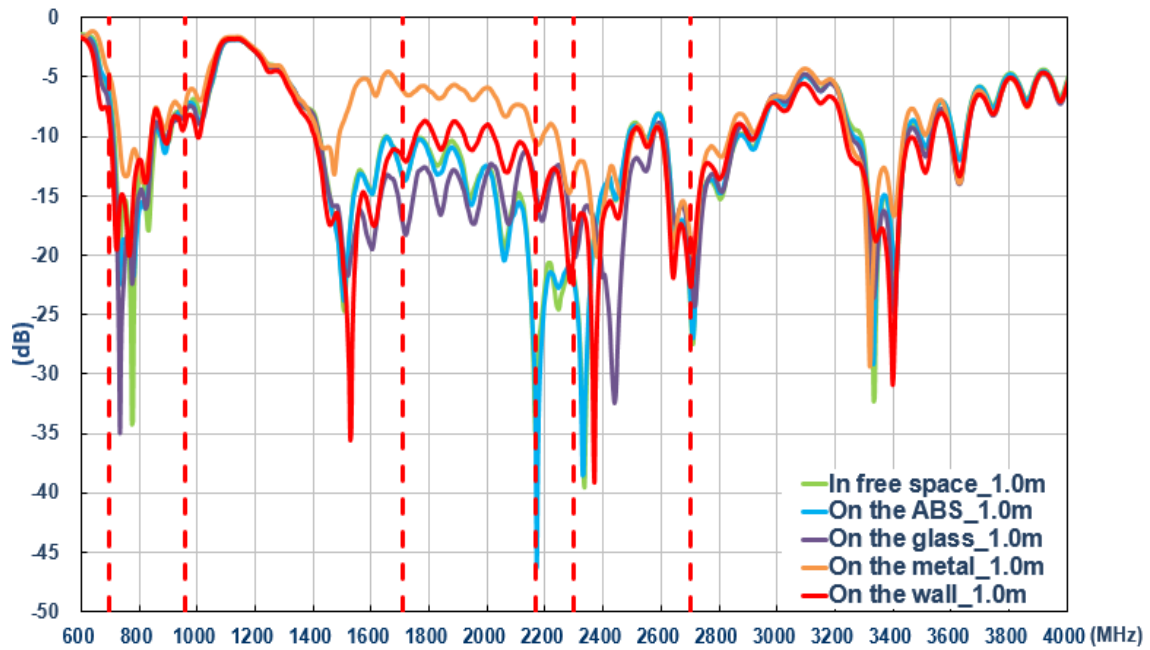

3.2.3 LTE_2 Antenna Return Loss

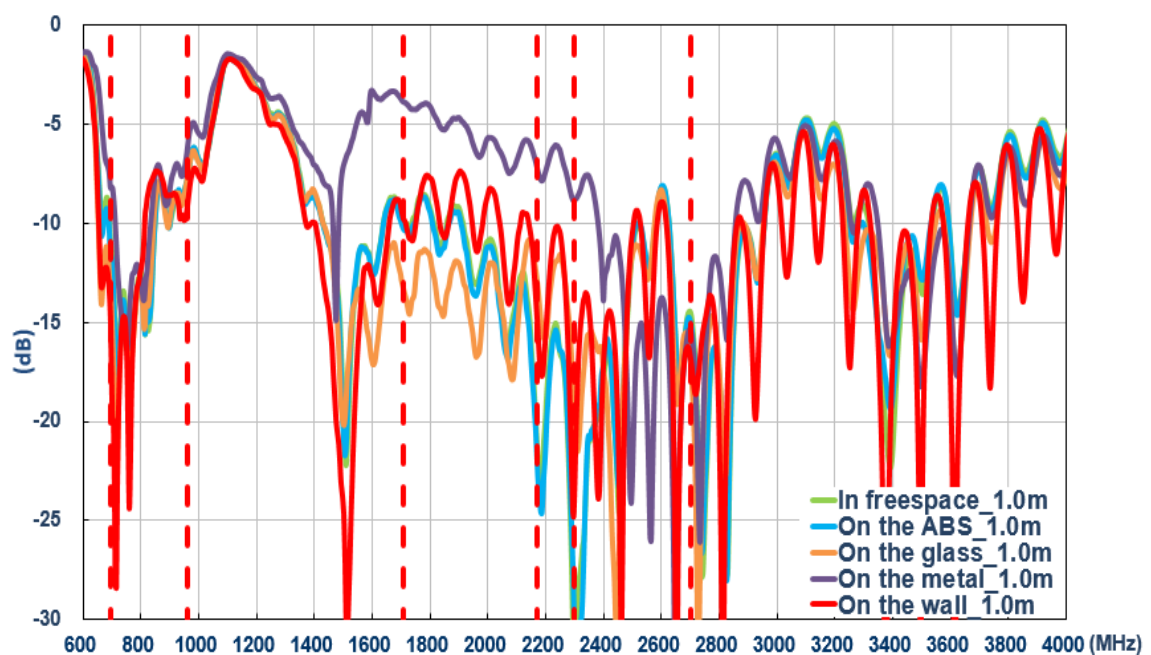

3.2.4 LTE Envelope Correlation Coefficient

Performance in different environments with 1 meter cable length

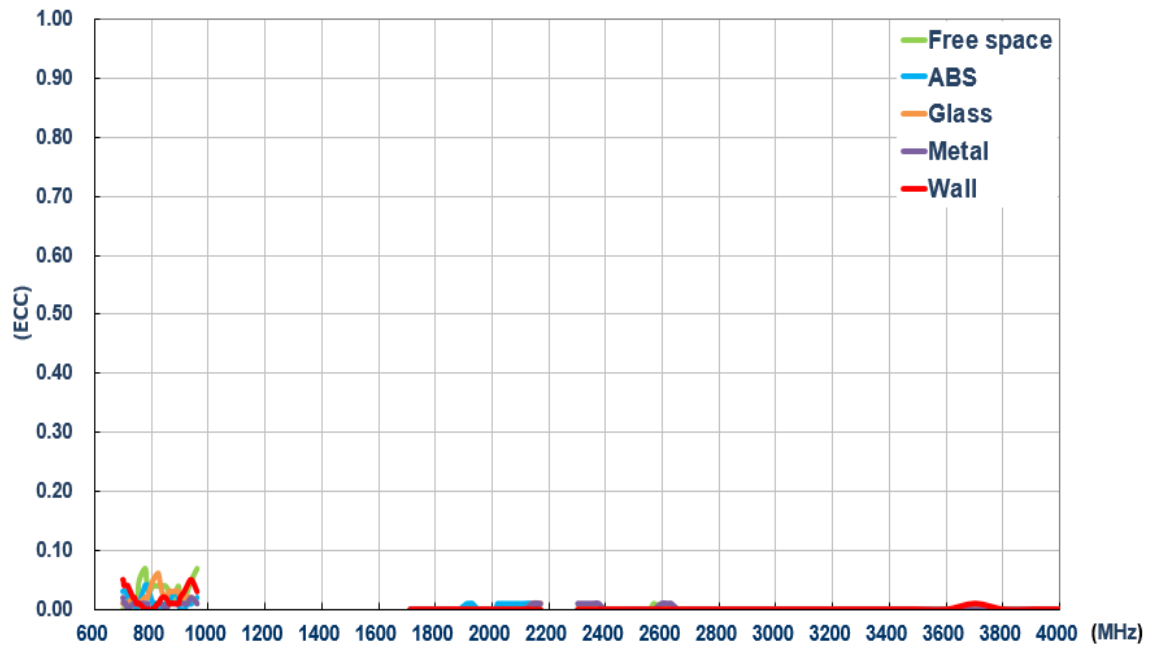

3.2.5 LTE_1 Antenna Efficiency

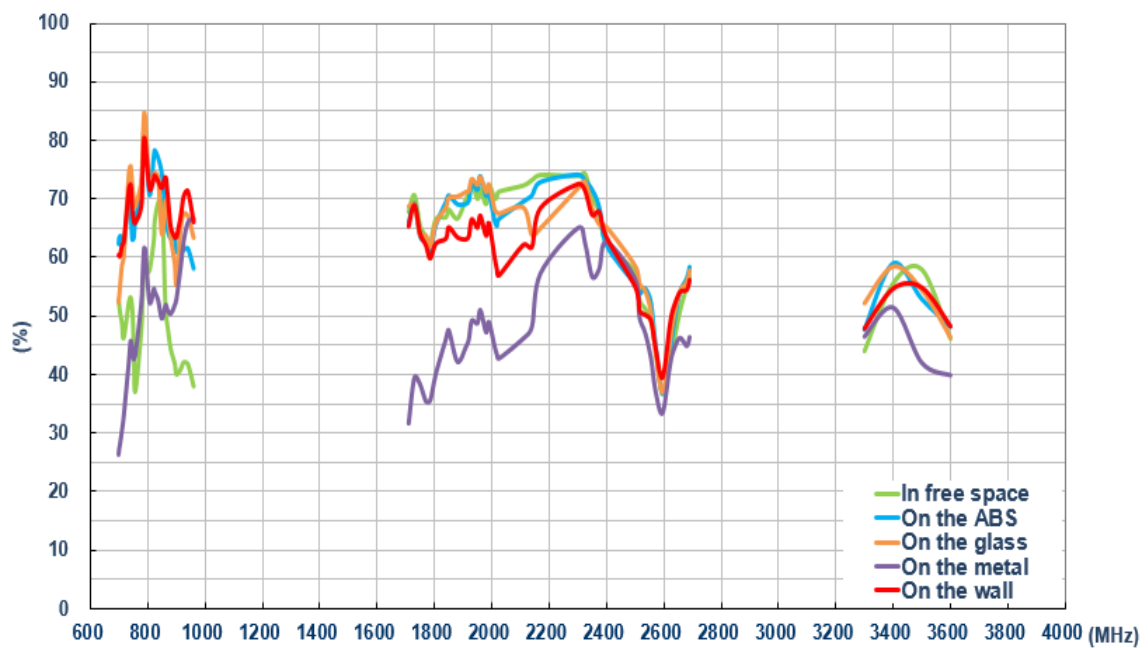

3.2.6 LTE_2 Antenna Efficiency

Performance in different environments with 1 meter cable length

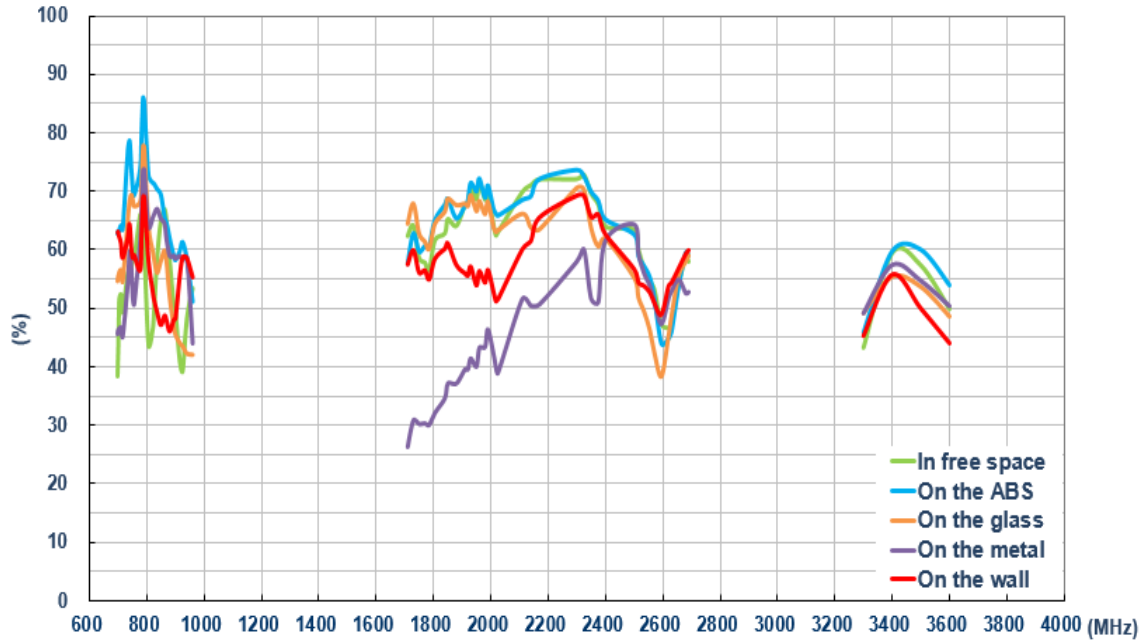

3.2.7 LTE_1 Antenna Average Gain (dBi)

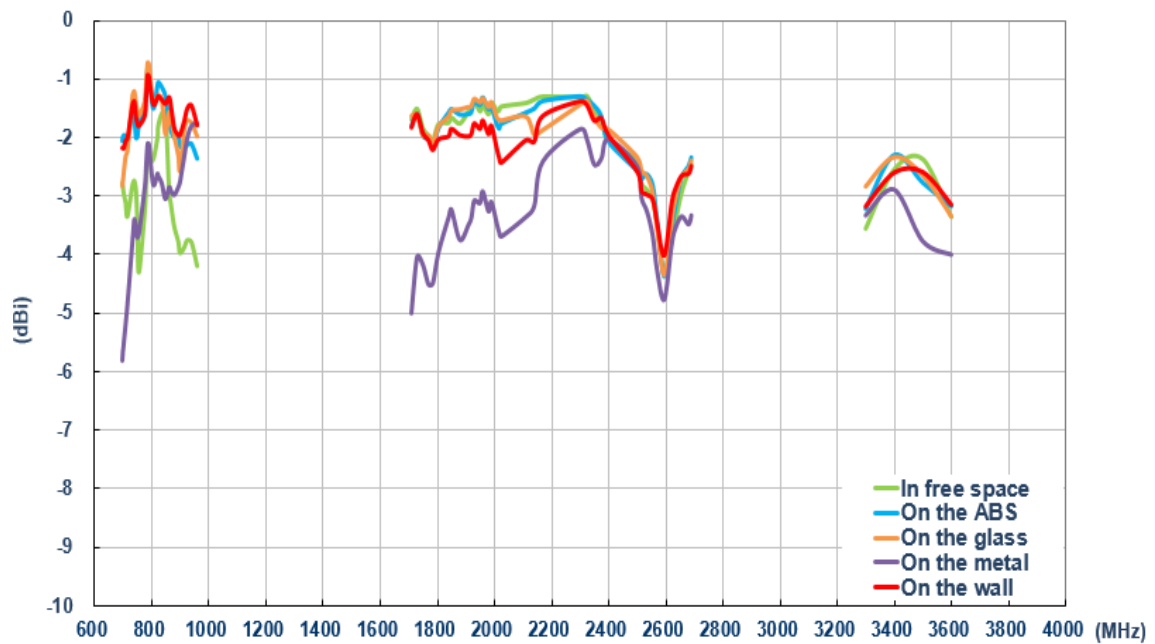

3.2.8 LTE_2 Antenna Average Gain

Performance in different environments with 1 meter cable length

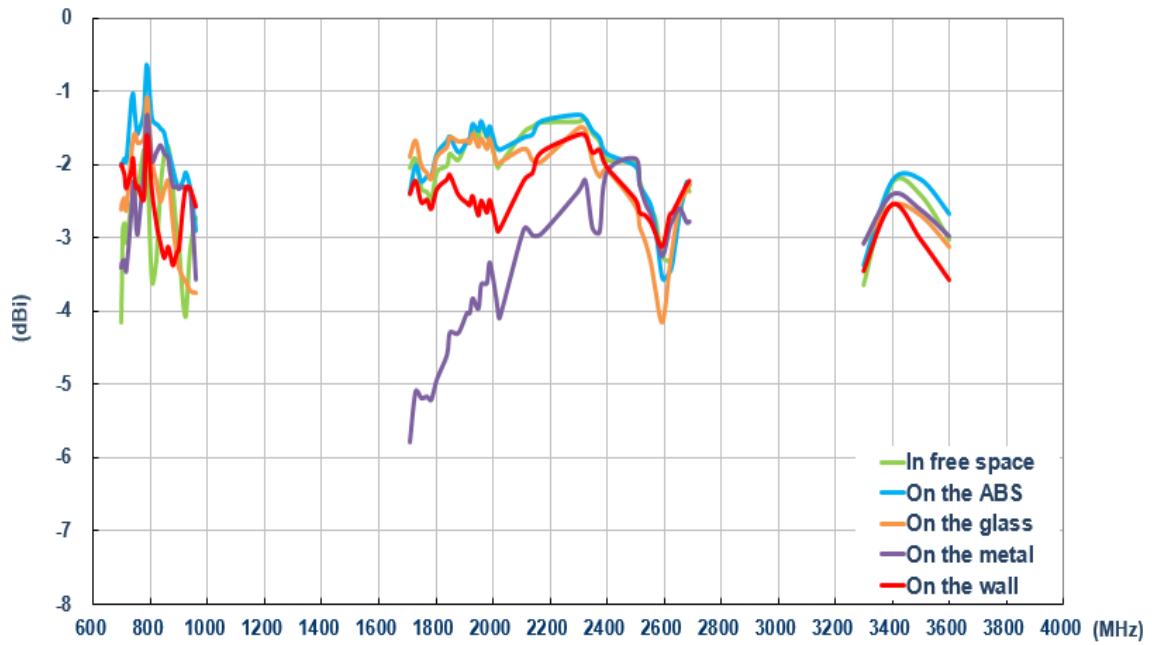

3.2.9 LTE_1 Antenna Peak Gain

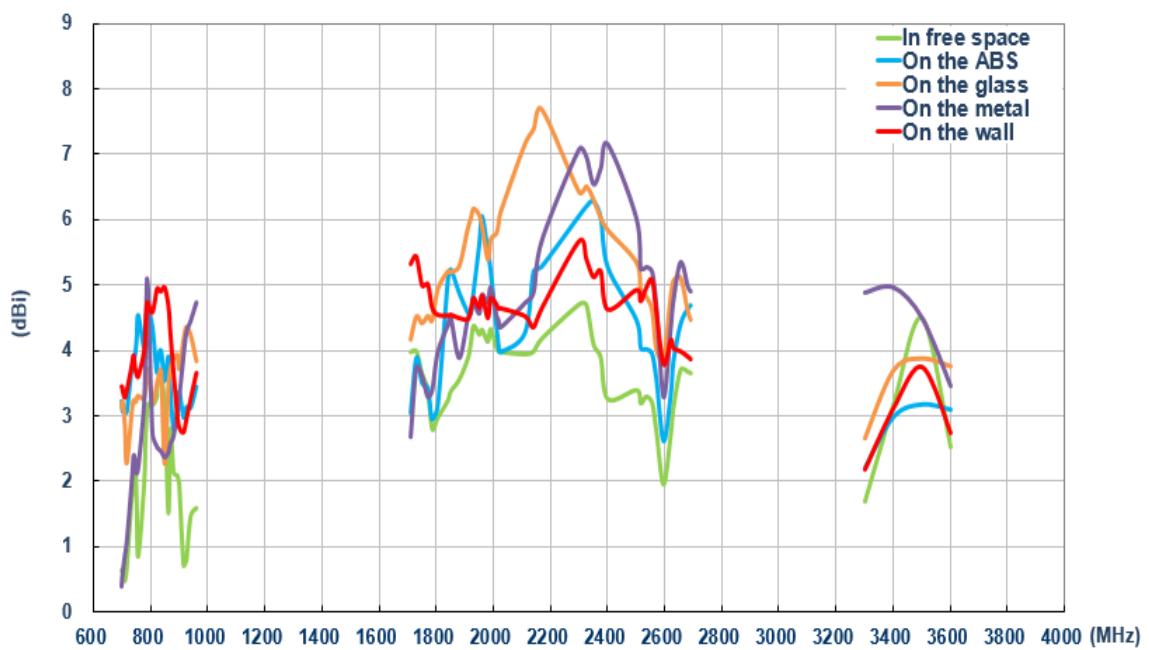

3.2.10 LTE_2 Antenna Peak Gain

Performance in different environments with 1 meter cable length

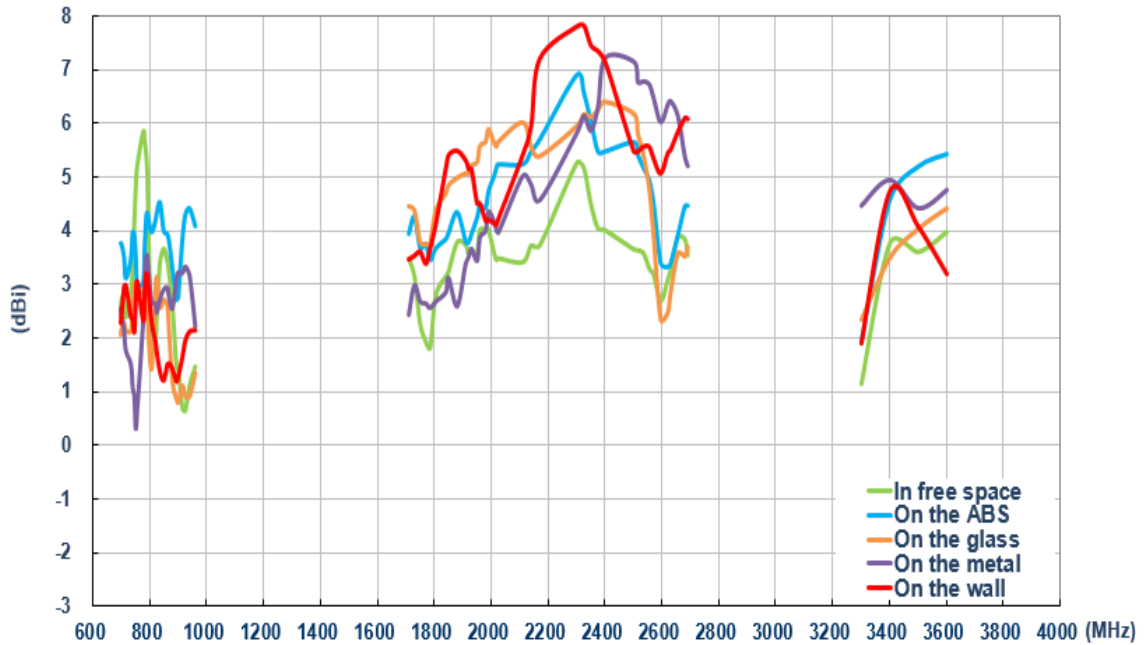

3.2.11 Wi-Fi_1 Antenna Return Loss

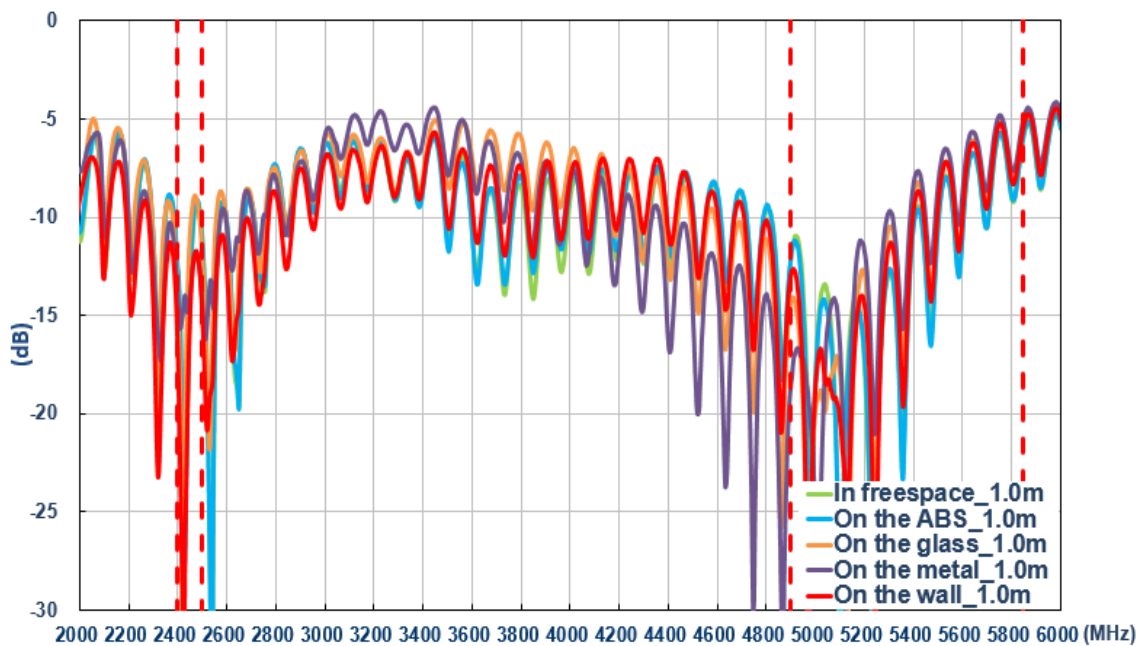

3.2.12 Wi-Fi_2 Antenna Return Loss

Performance in different environments with 1 meter cable length

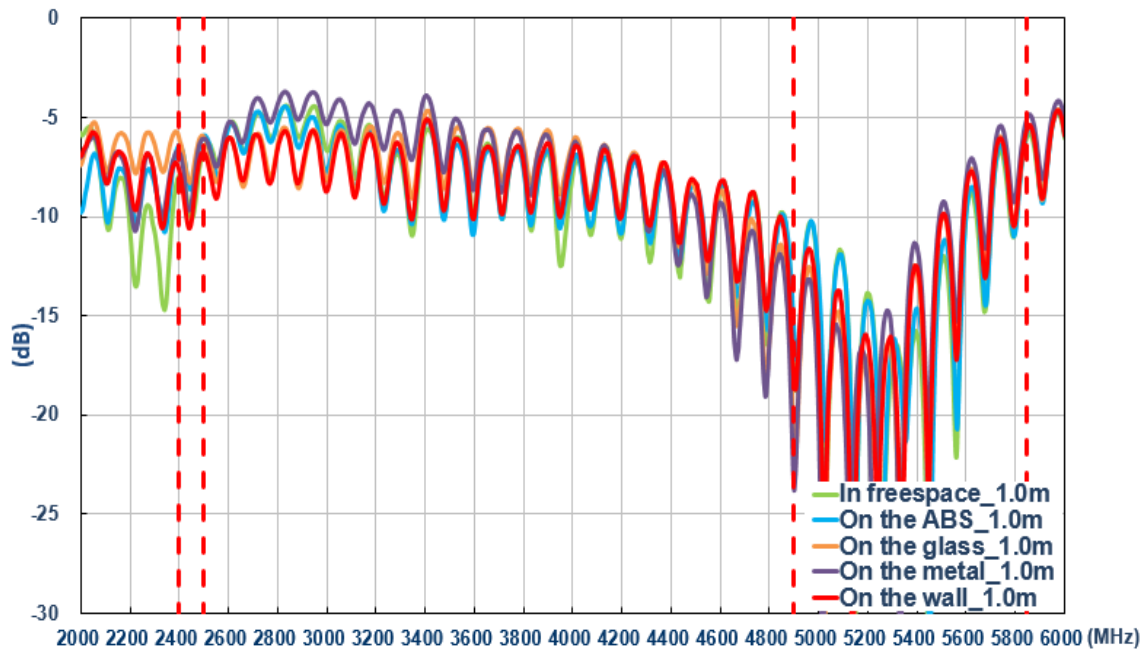

3.2.13 Wi-Fi Envelope Correlation Coefficient

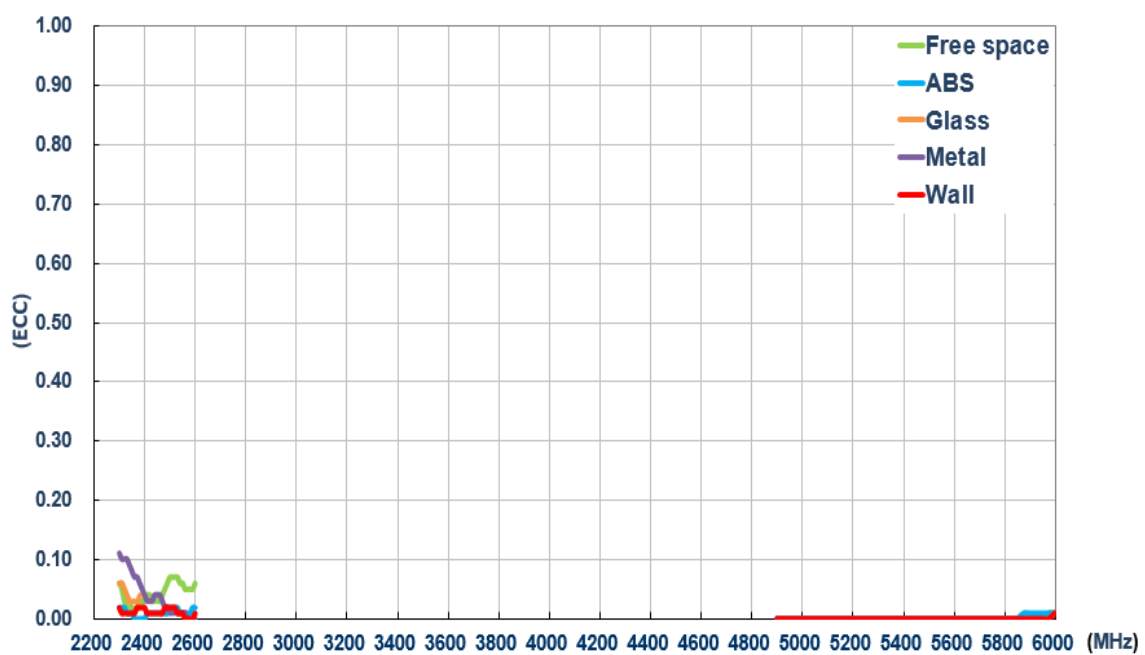

3.2.14 Wi-Fi_1 Antenna Efficiency

Performance in different environments with 1 meter cable length

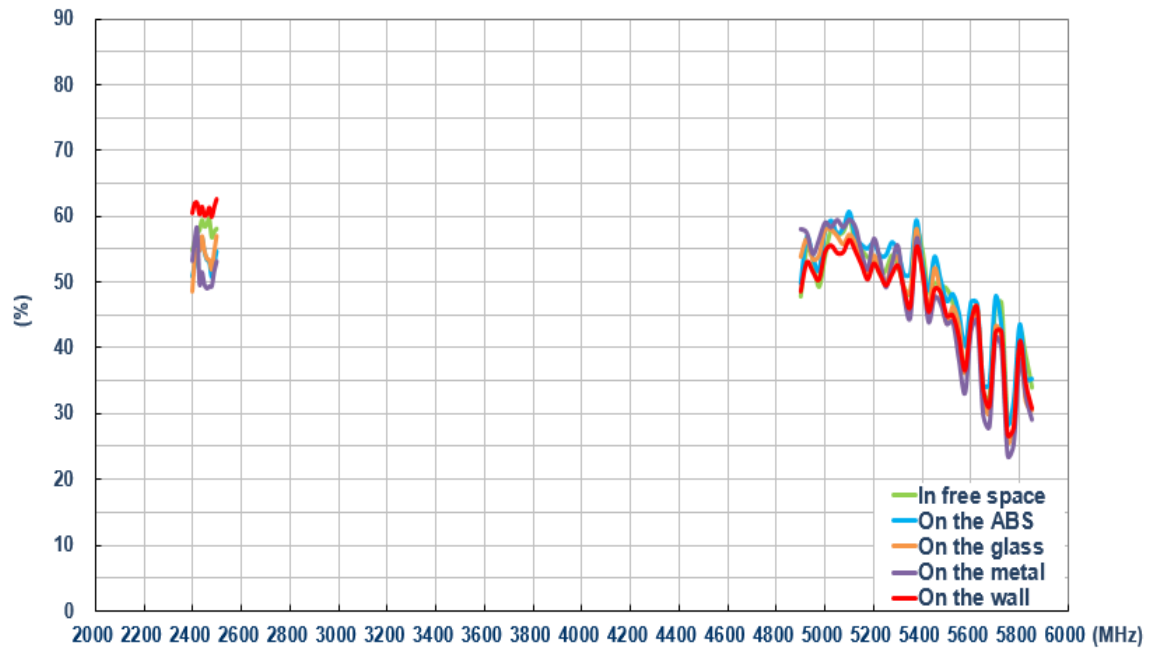

3.2.15 Wi-Fi_2 Antenna Efficiency

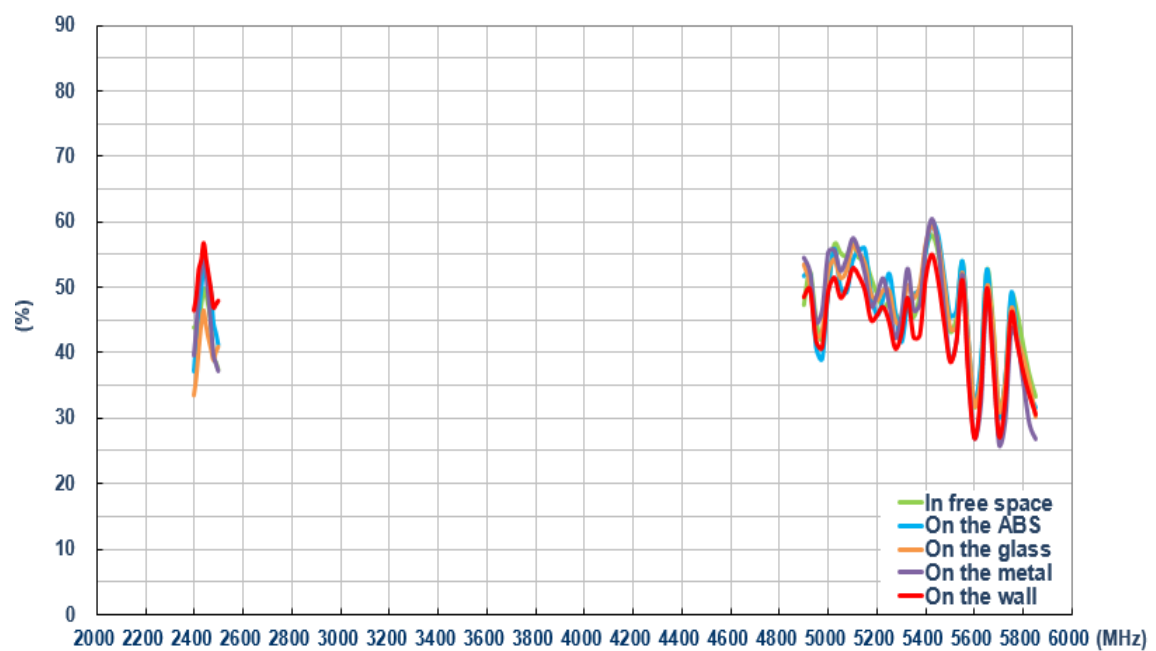

3.2.16 Wi-Fi_1 Antenna Average Gain

Performance in different environments with 1 meter cable length

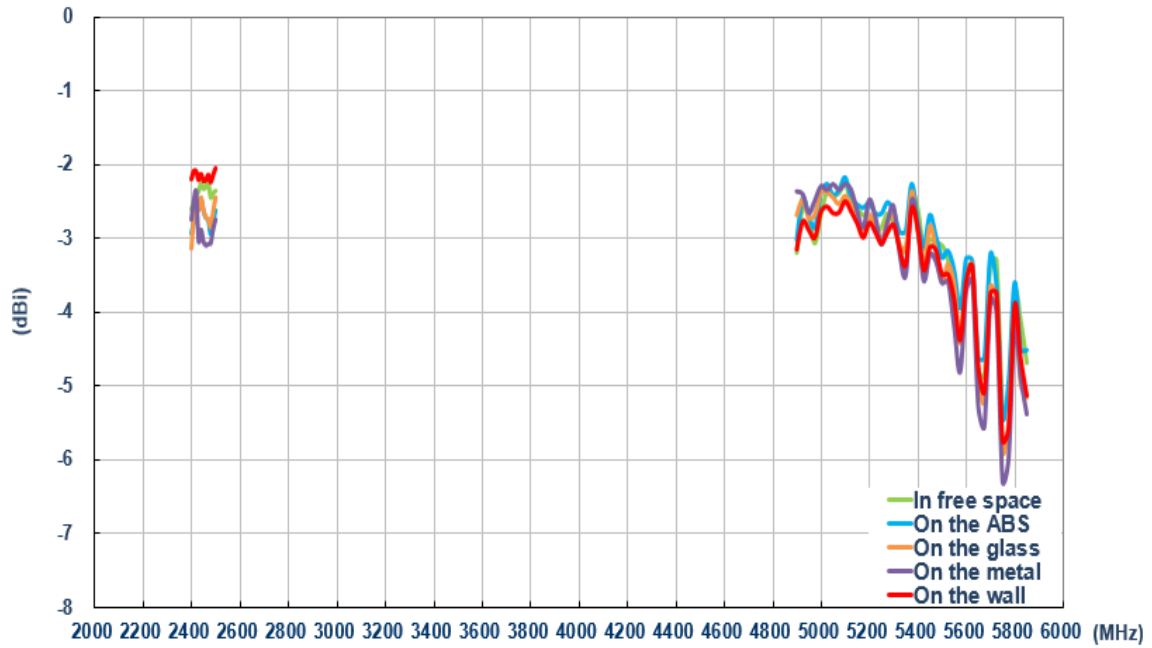

3.2.17 Wi-Fi_2 Antenna Average Gain

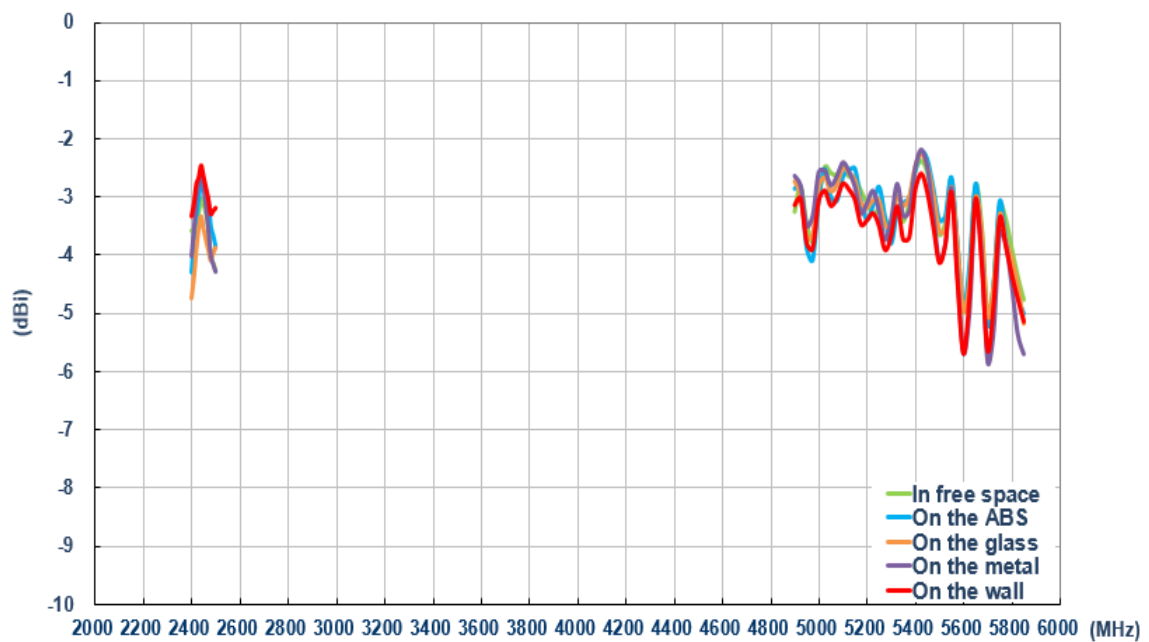

3.2.18 Wi-Fi_1 Antenna Peak Gain

Performance in different environments with 1 meter cable length

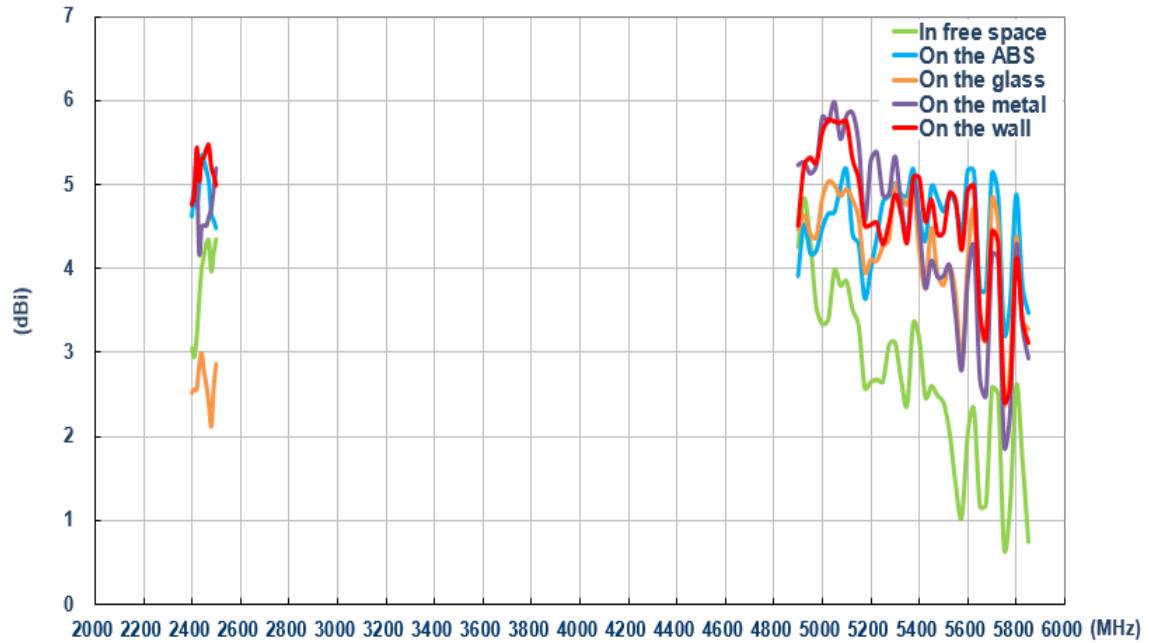

3.2.19 Wi-Fi_2 Antenna Peak Gain

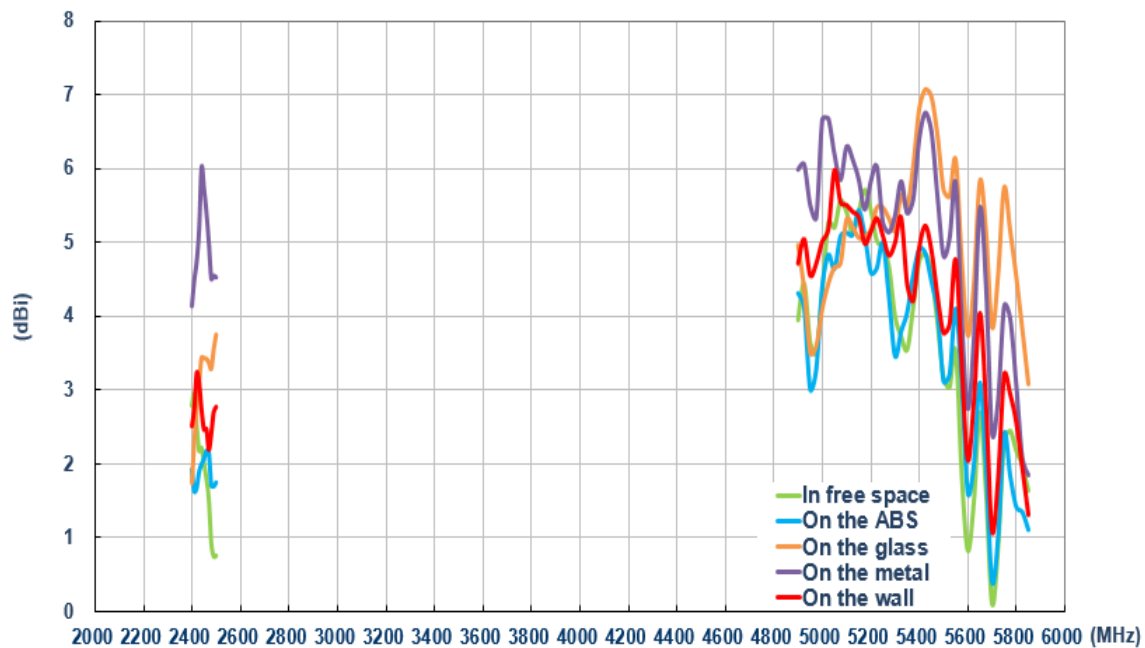

3.2.20 Test Setup for Antenna Radiation Pattern

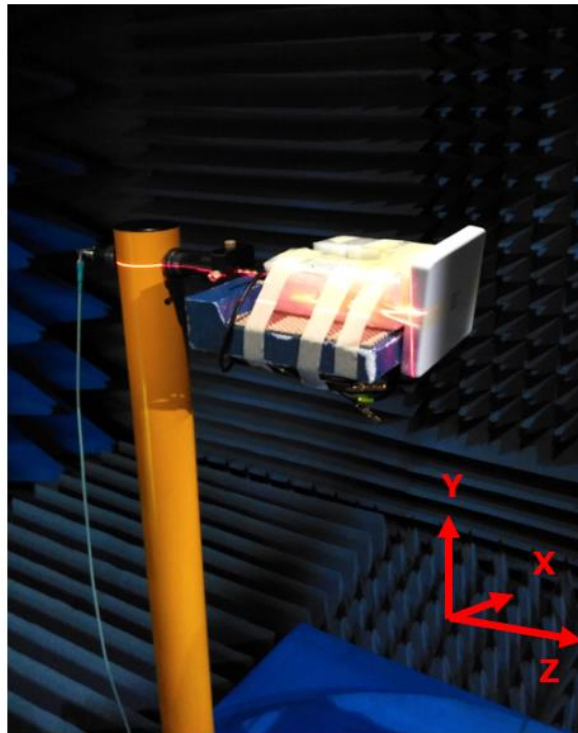

Free space

3.2.21 2D Radiation Patterns (LTE_MIMO1 with 1M cable length in free space)

XY Plane

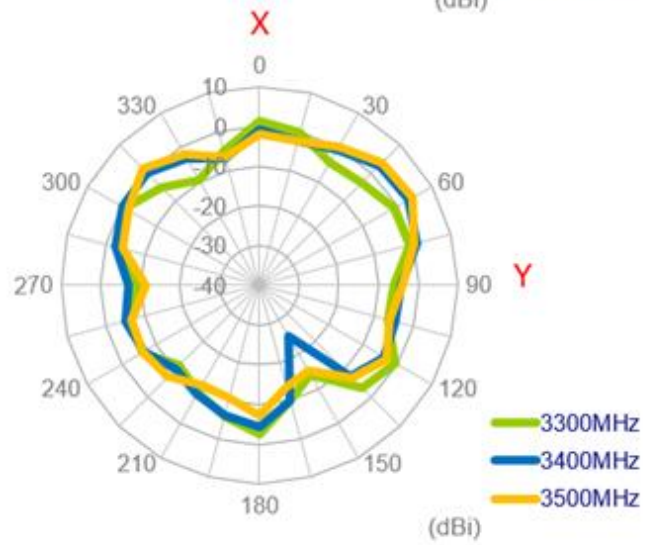
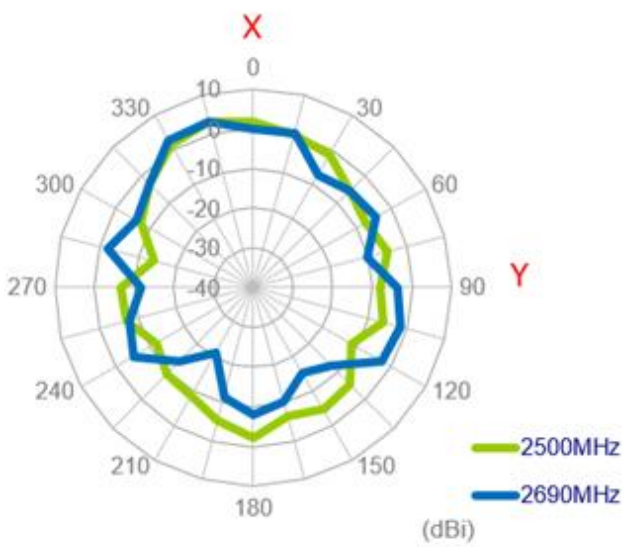
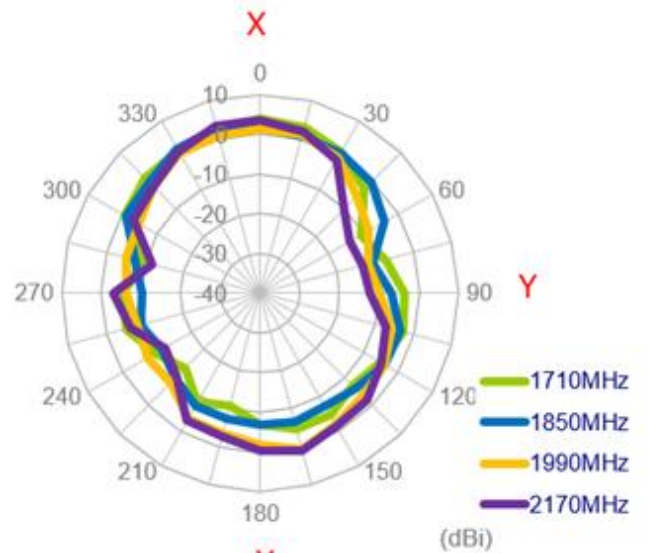
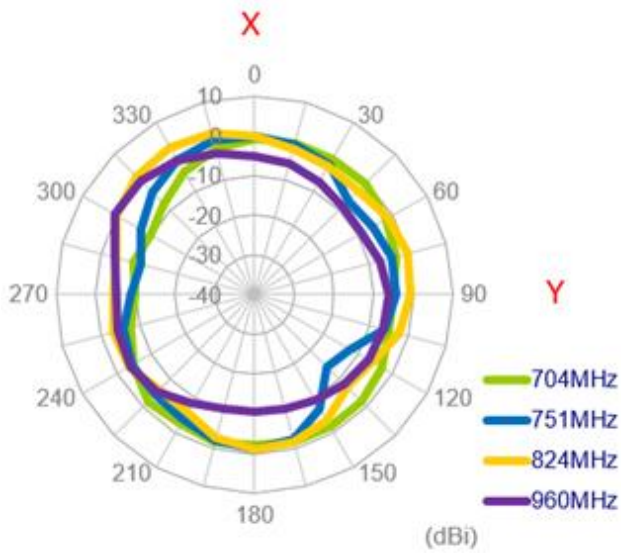

XZ Plane

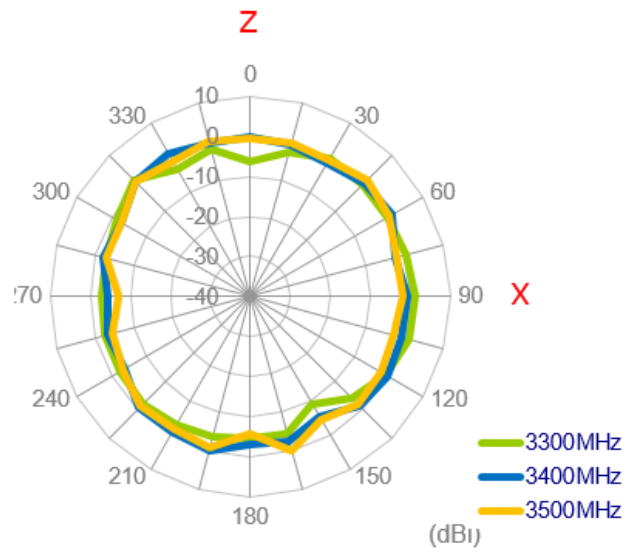
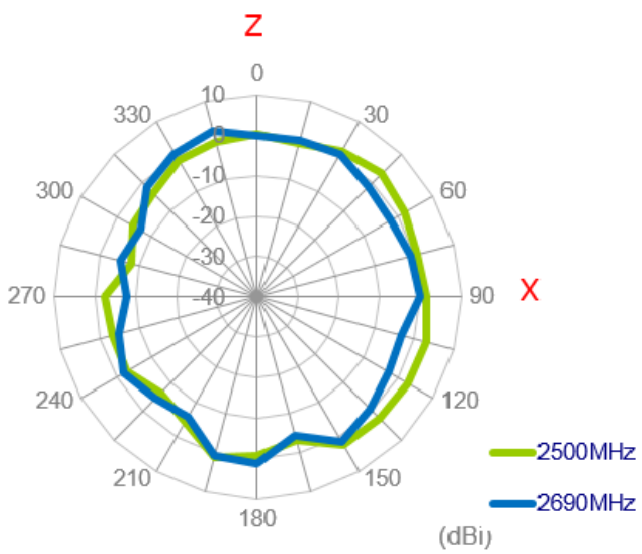
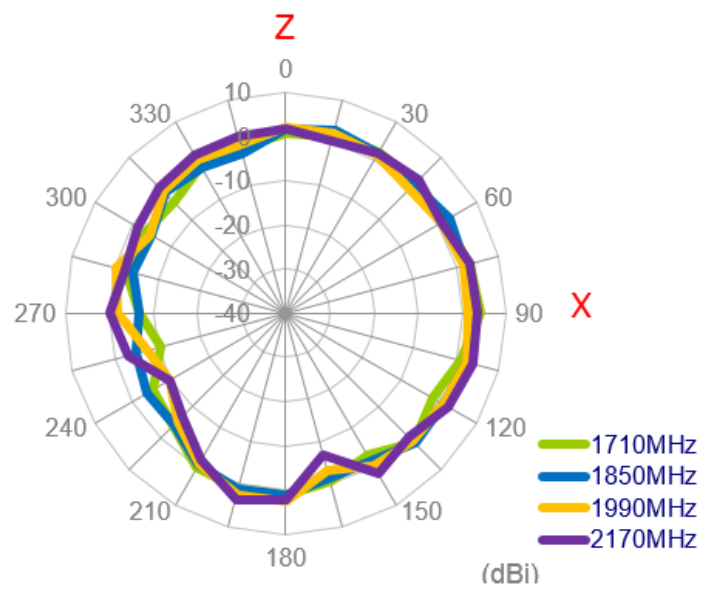
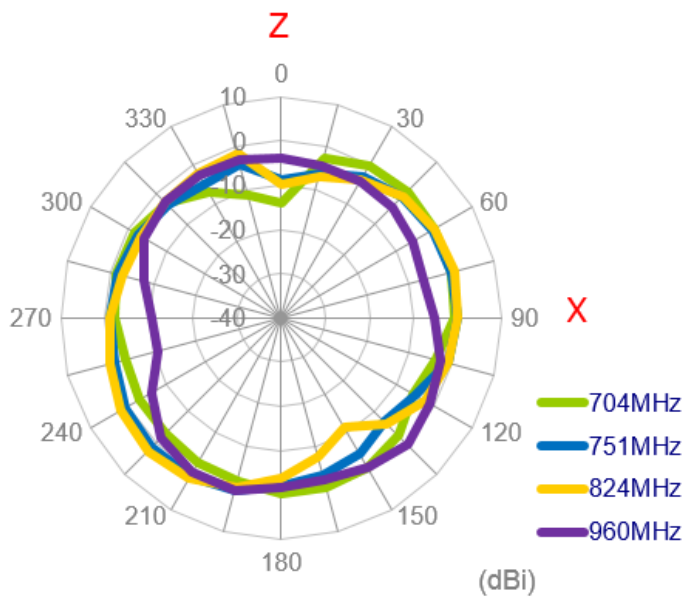

YZ Plane

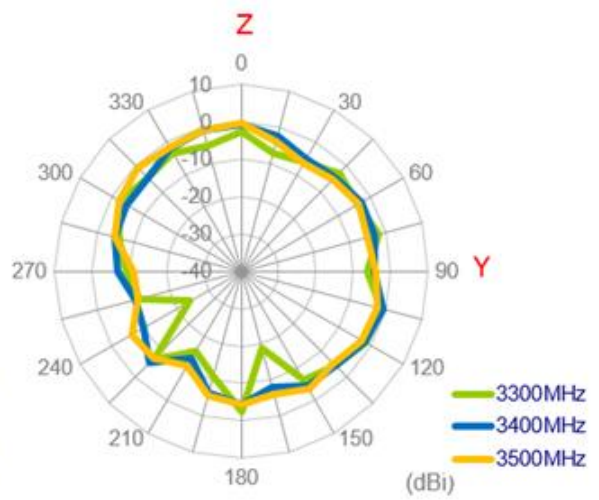
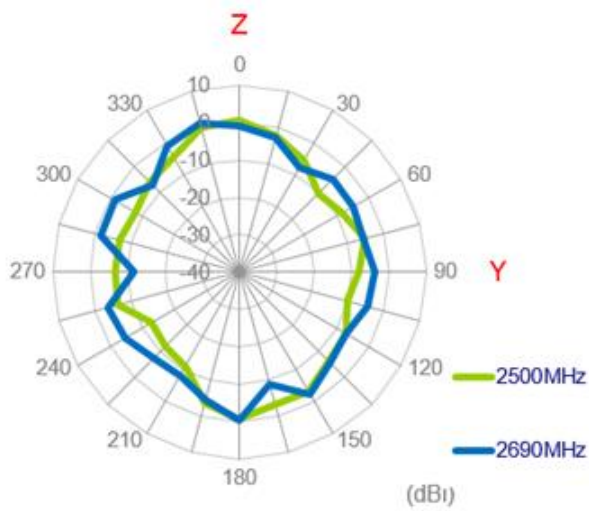
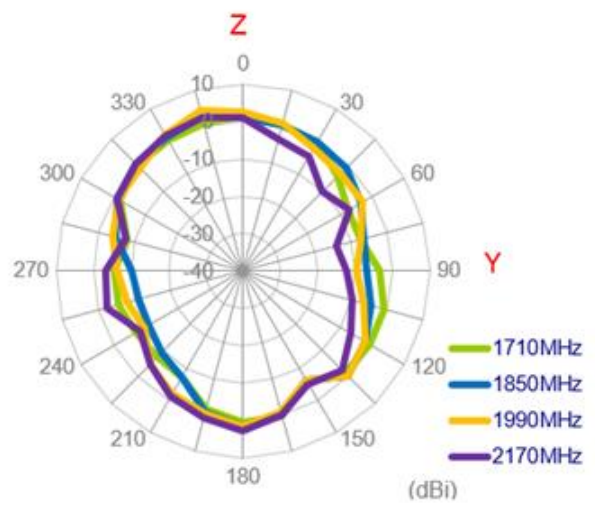
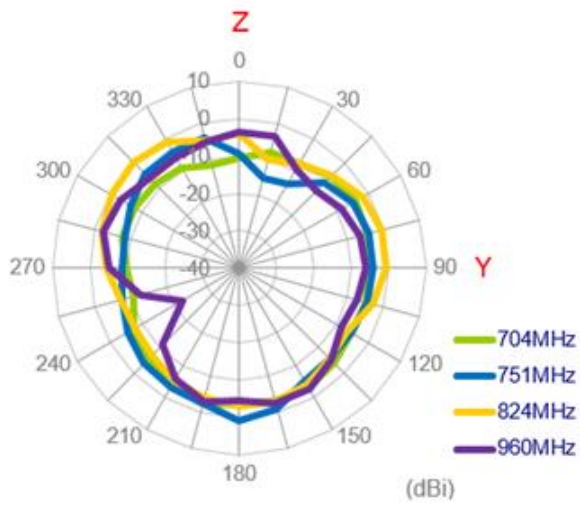

3.2.22 3D Radiation Patterns (LTE_MIMO1 with 1M cable length in free space)

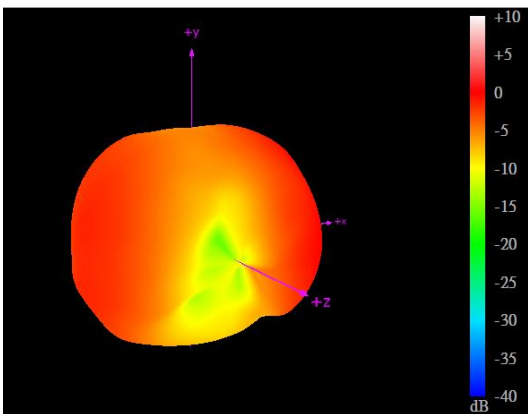

704MHz

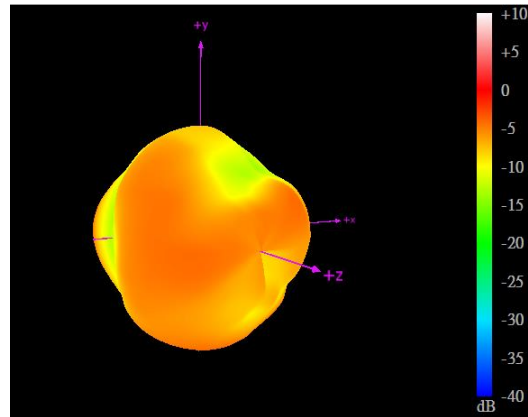

960MHz

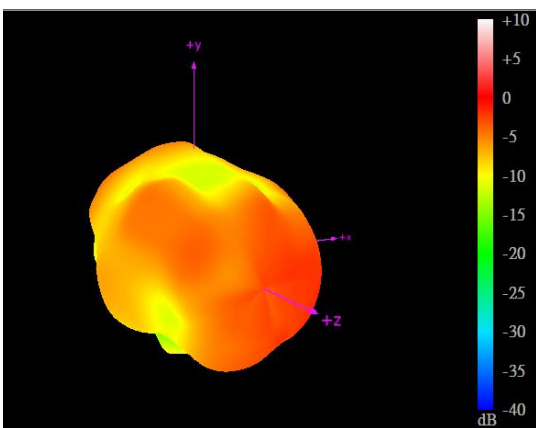

1710MHz

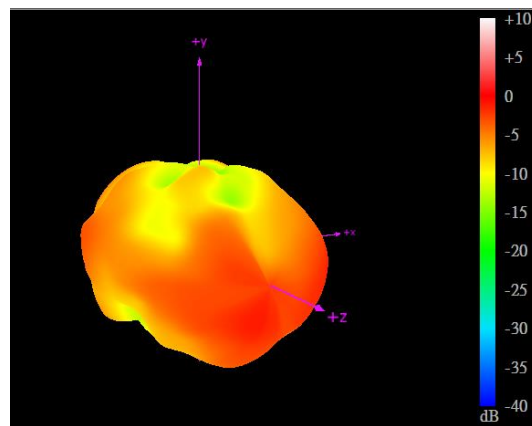

2170MHz

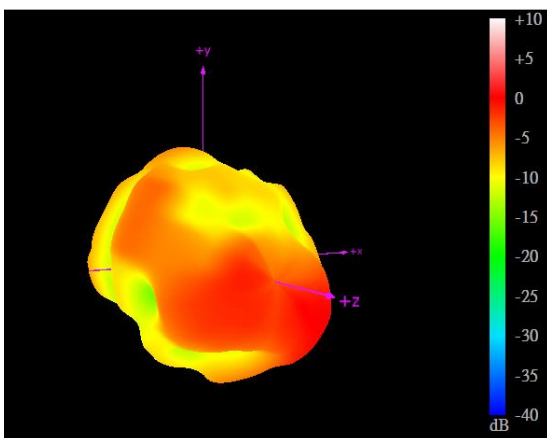

2690MHz

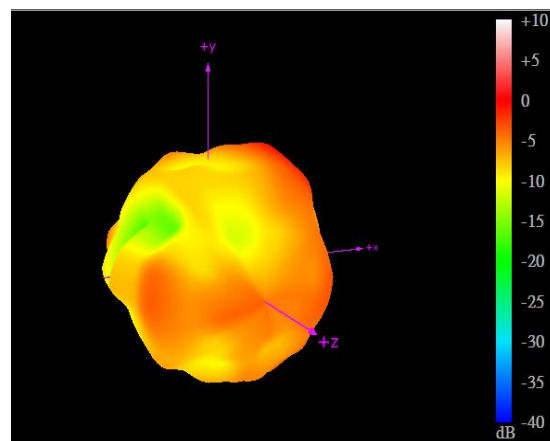

3500MHz

3.2.23 2D Radiation Patterns (LTE_MIMO2 with 1M cable length in free space)

XY Plane

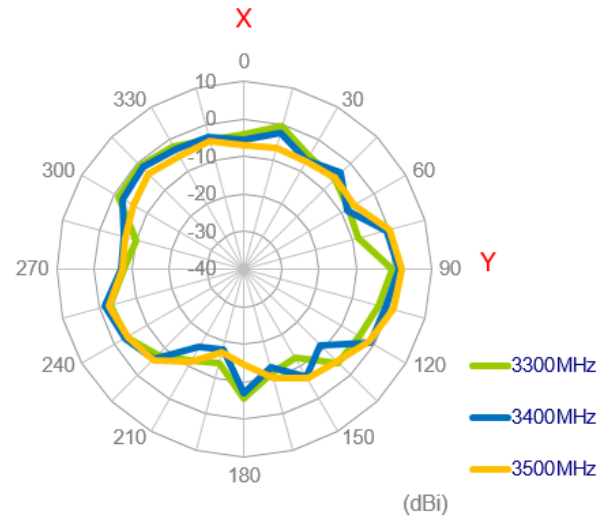
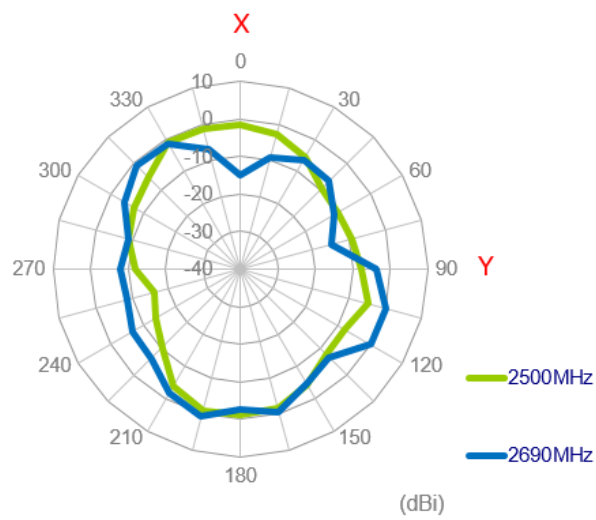
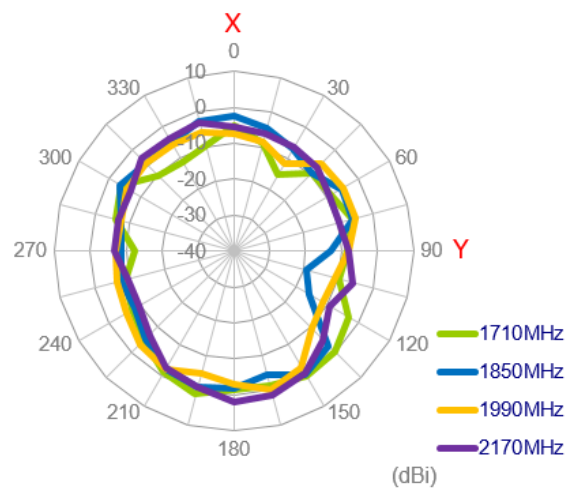
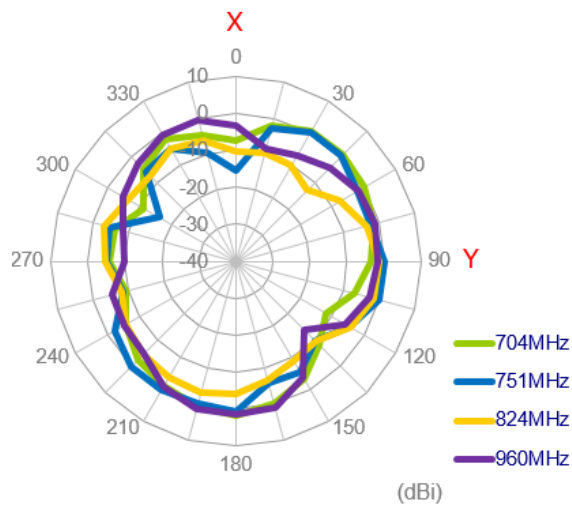

XZ Plane

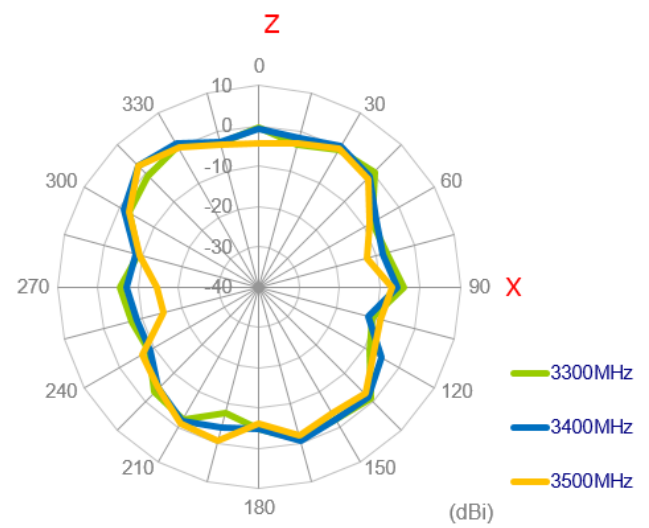
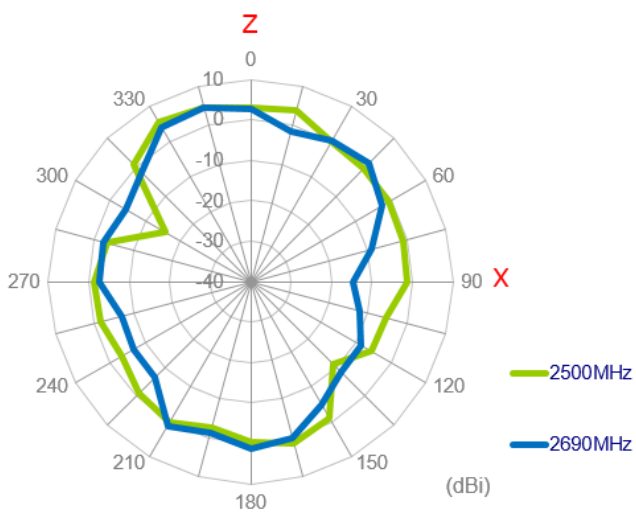
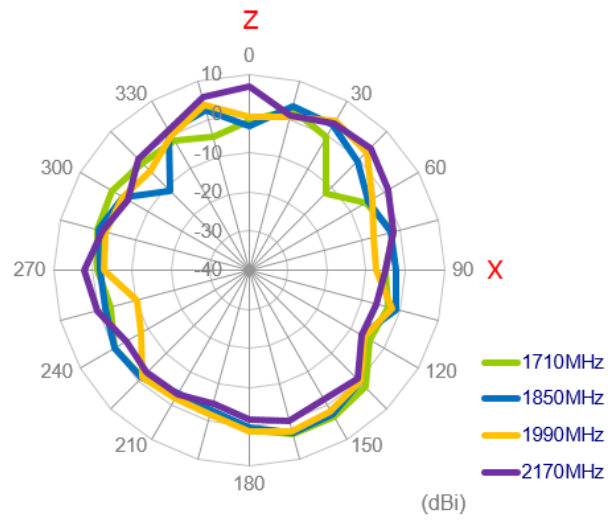
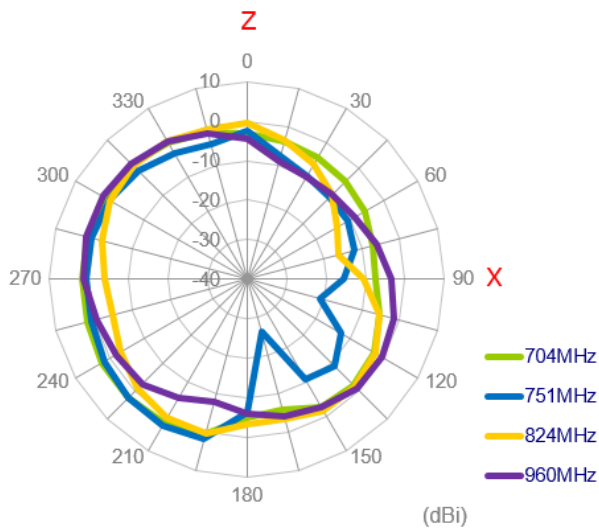

YZ Plane

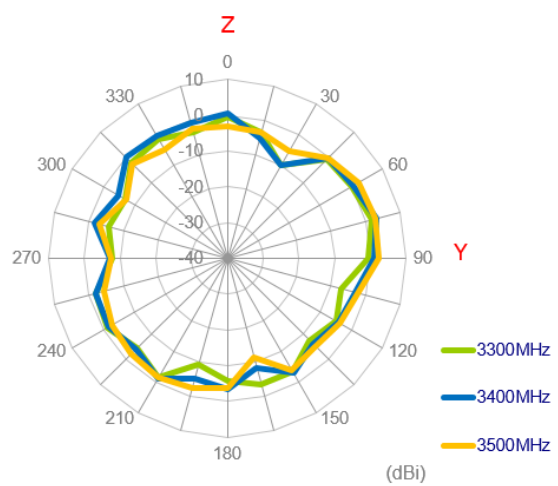
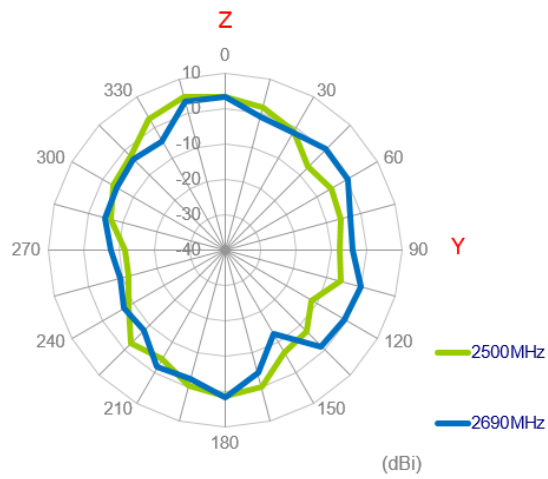
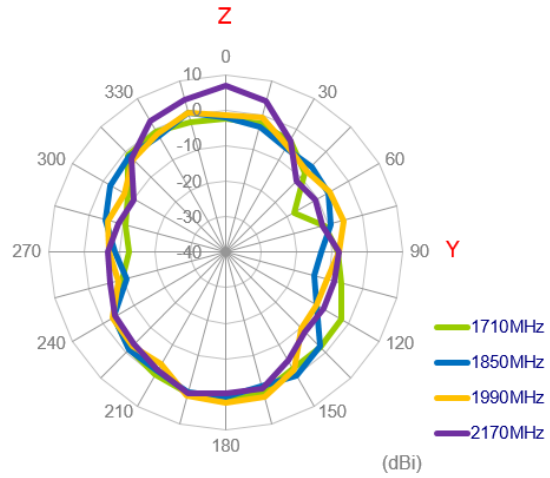
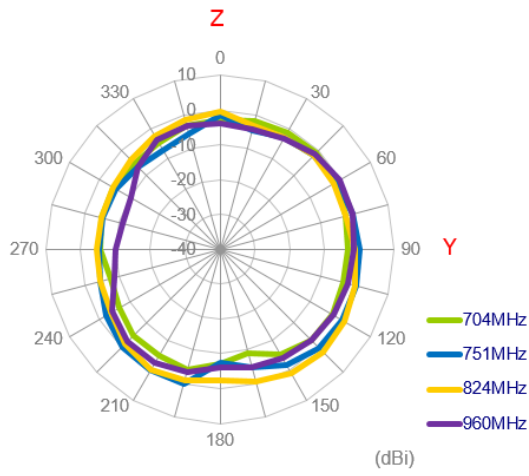

3.2.24 3D Radiation Patterns (LTE_MIMO2 with 1M cable length in free space)

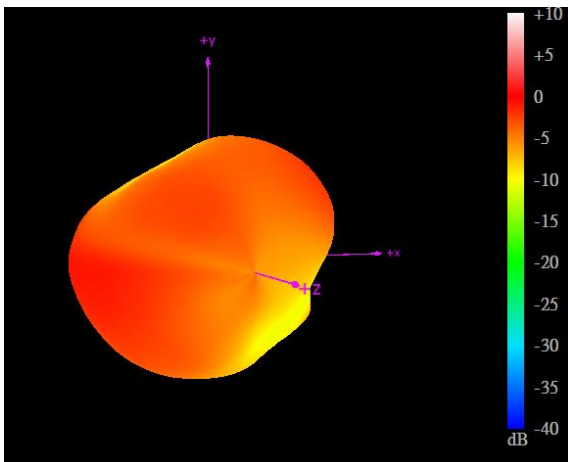

704MHz

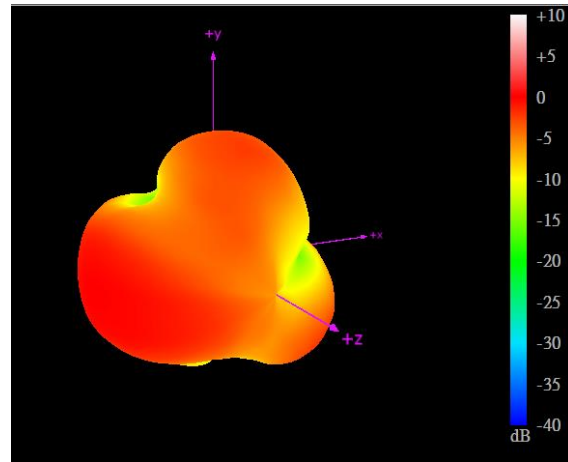

960MHz

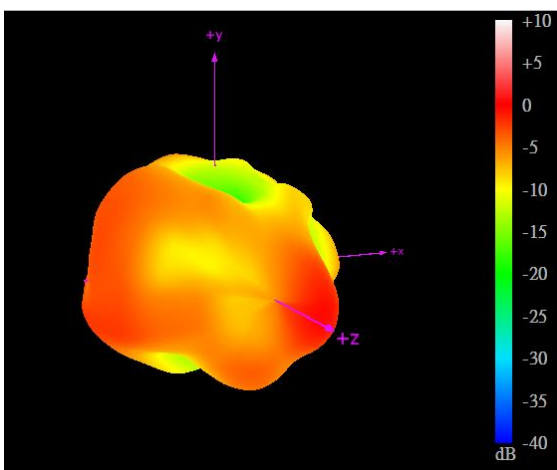

1710MHz

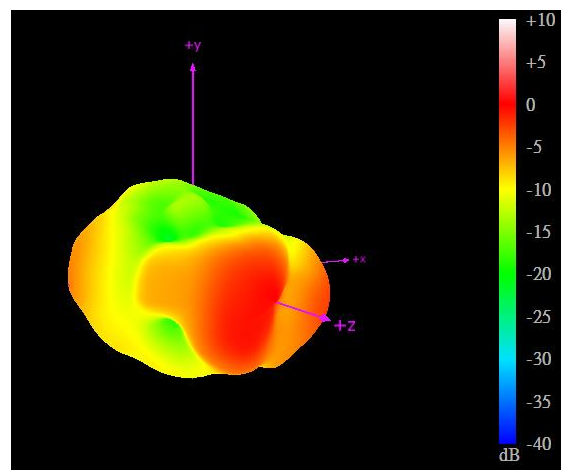

2170MHz

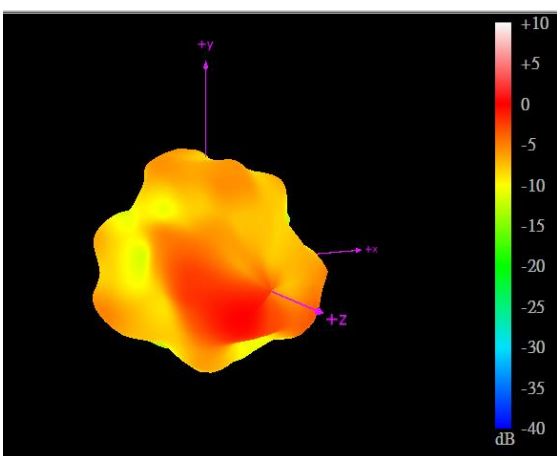

2690MHz

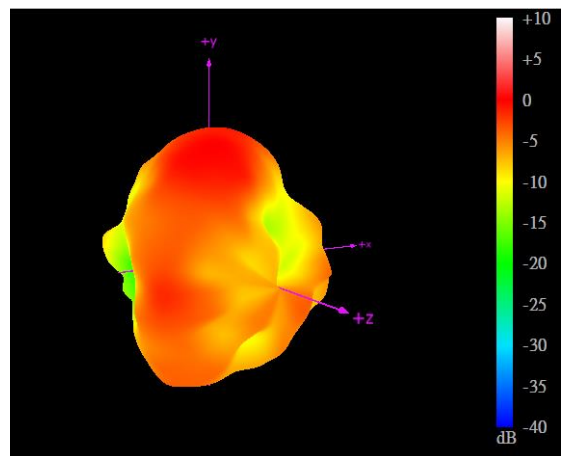

3500MHz

3.2.25 2D Radiation Patterns (LTE_MIMO1 with 1M cable length in free space)

XY Plane

XY Plane

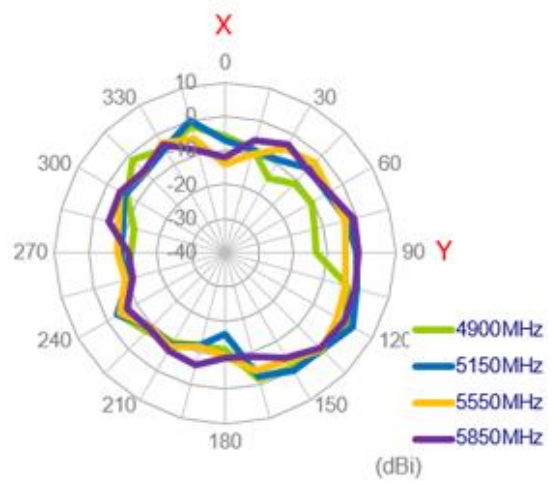
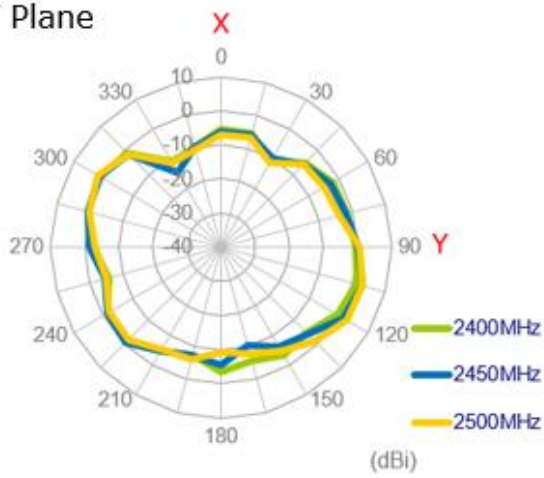

XZ Plane

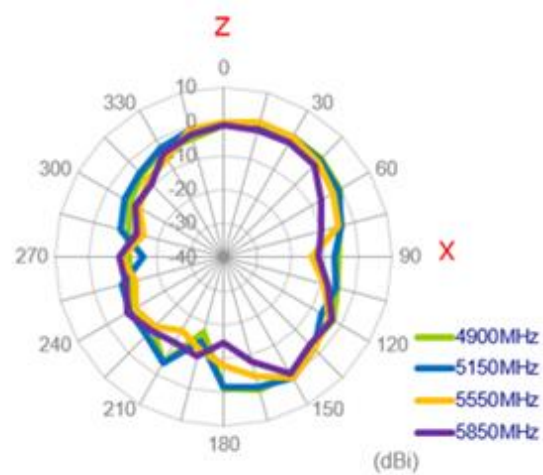
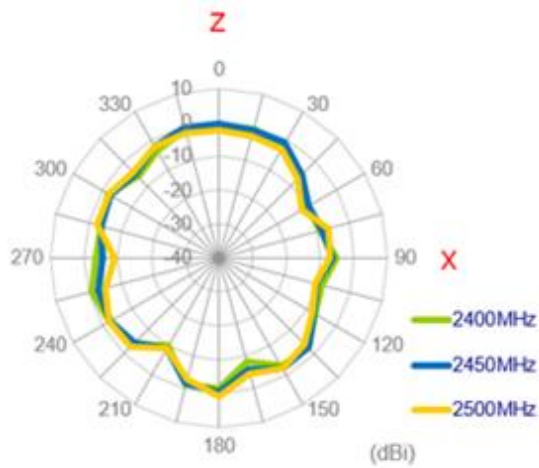

YZ Plane

YZ Plane

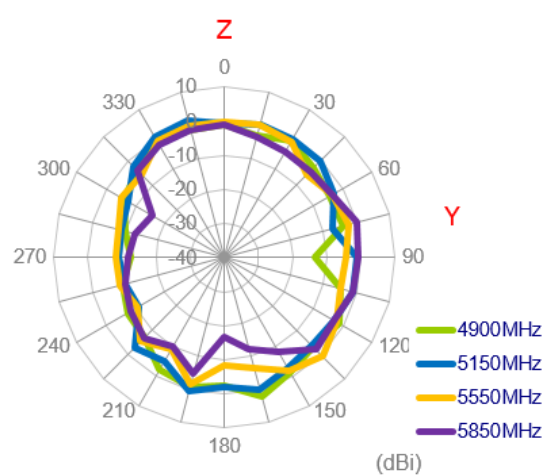
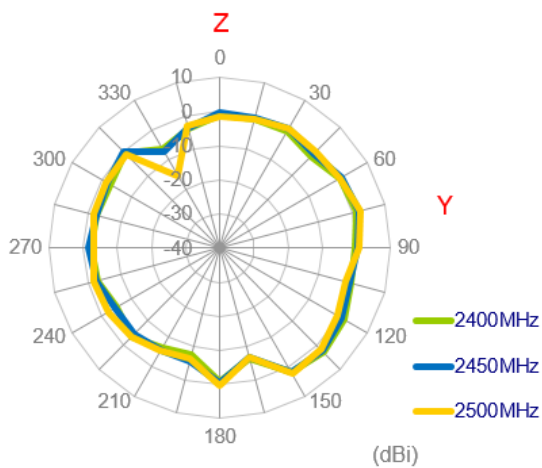

3.2.26 3D Radiation Patterns Pattern (Wi-Fi_MIMO1 with 1M cable length in free space)

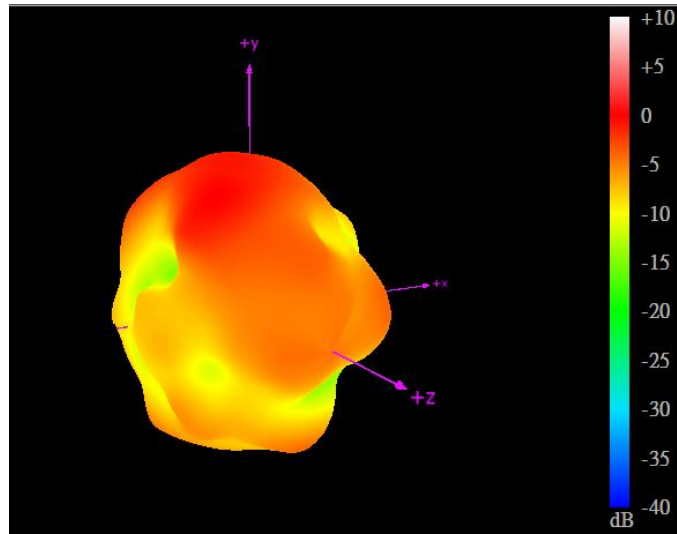

2450MHz

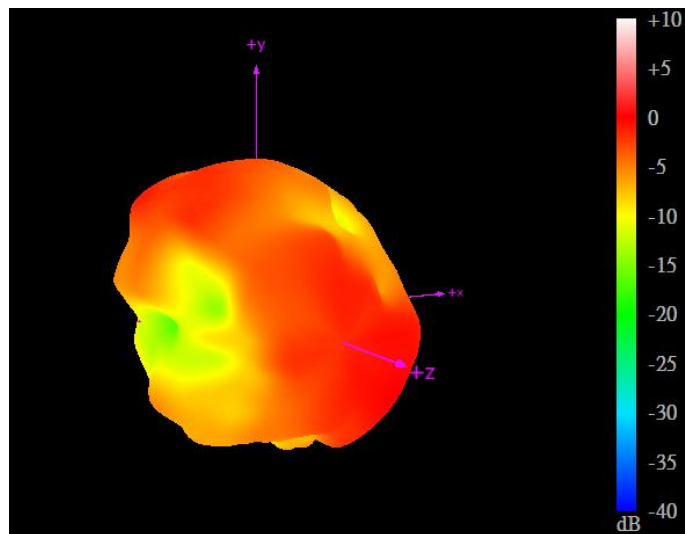

5550MHz

3.2.27 2D Radiation Patterns (Wi-Fi_MIMO2 with 3M cable length in free space)

XY Plane

XY Plane

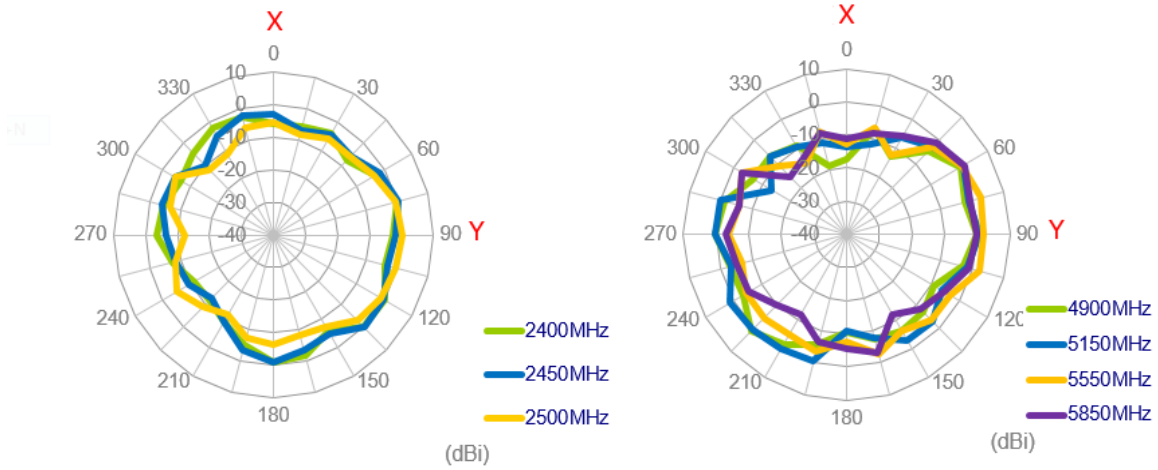

XZ Plane

XZ Plane

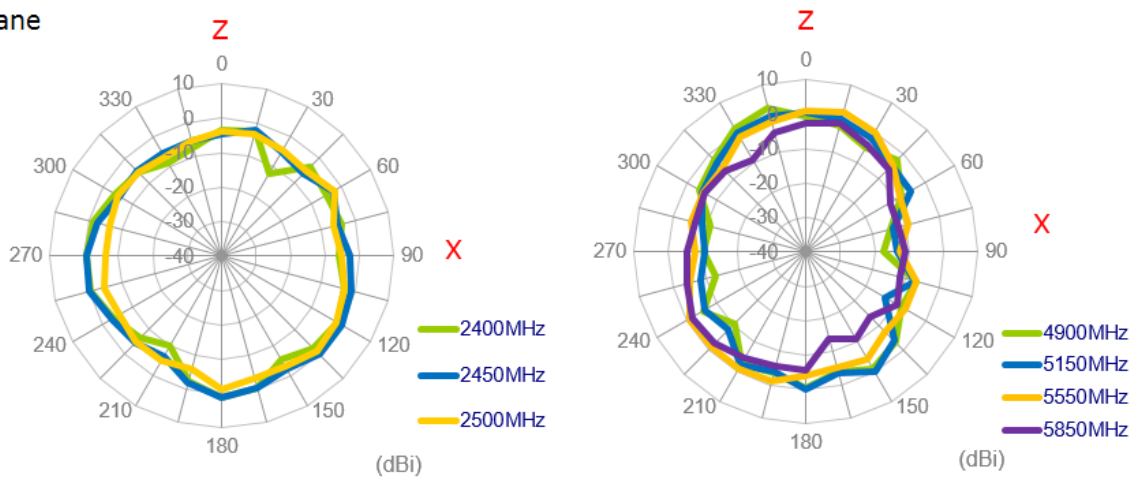

YZ Plane

YZ Plane

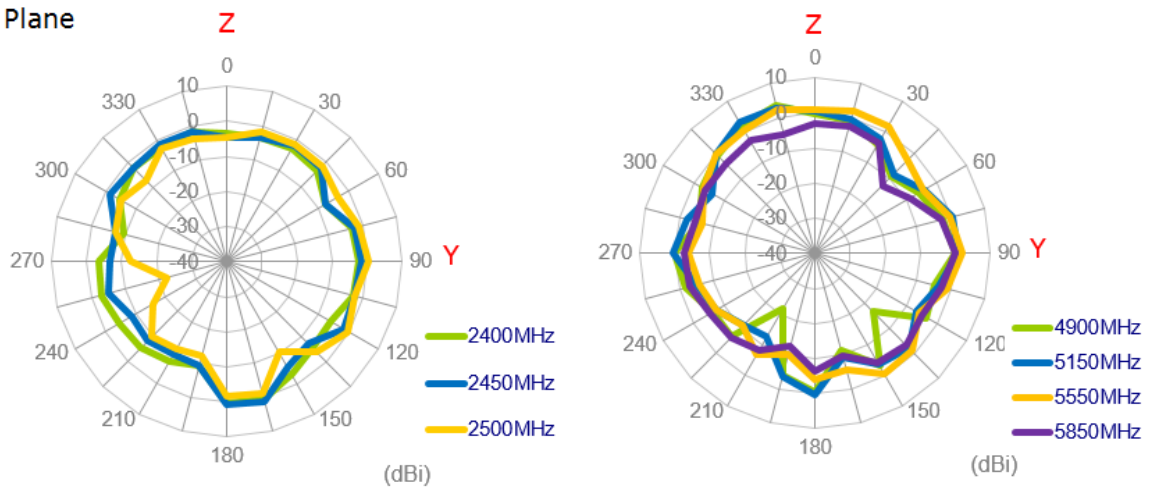

3.2.28 3D Radiation Patterns Pattern (Wi-Fi_MIMO2 with 1M cable length in free space)

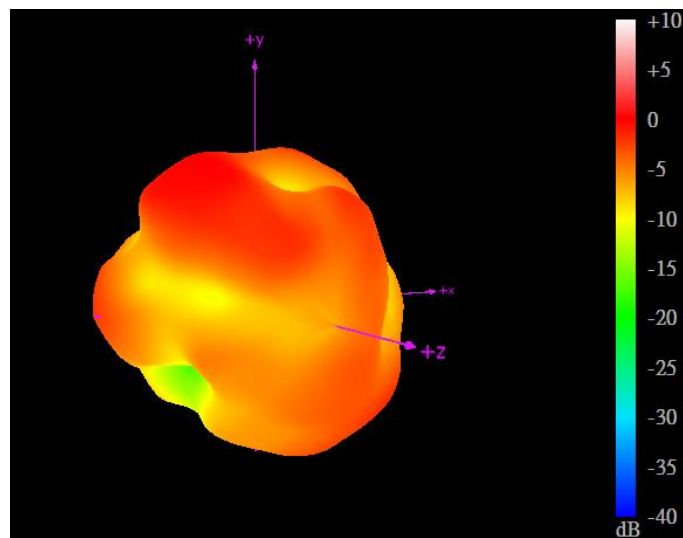

2450MHz

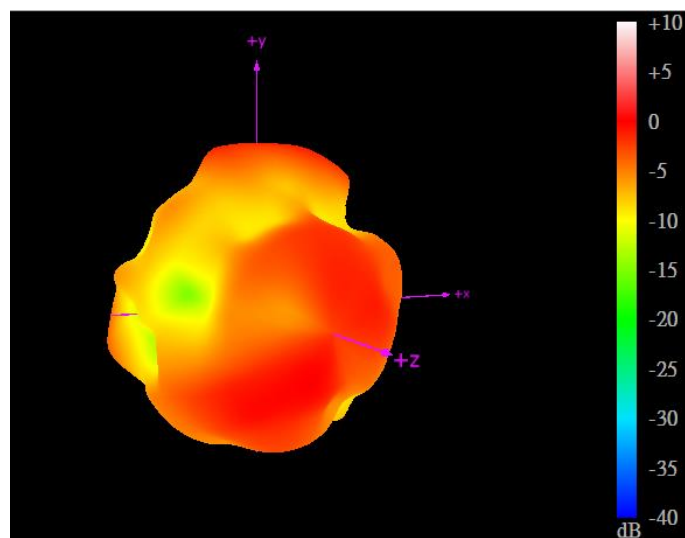

5550MHz

3.2.29 Test Setaup for Antenna Radiation Pattern



On the ABS

3.2.30 2D Radiation Patterns (LTE_MIMO1 with 1M cable length on ABS)

XY Plane

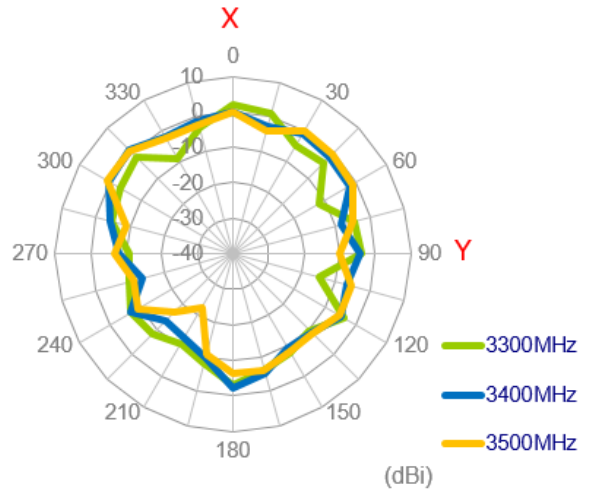
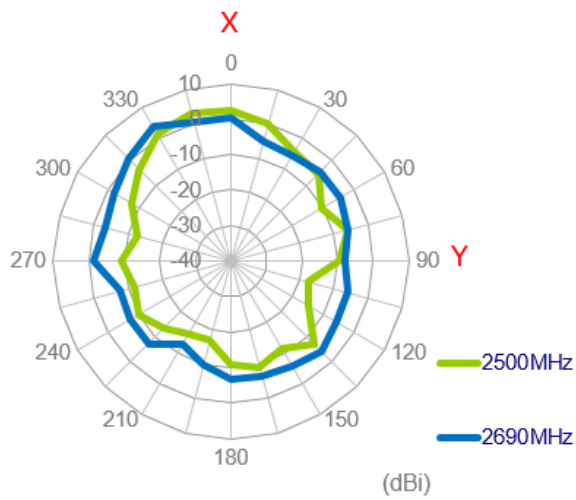
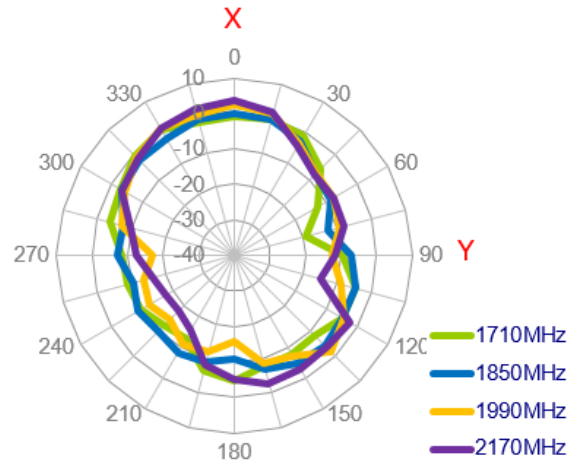
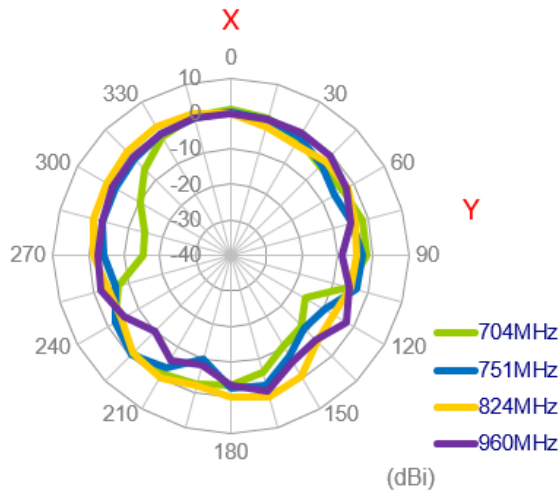

XZ Plane

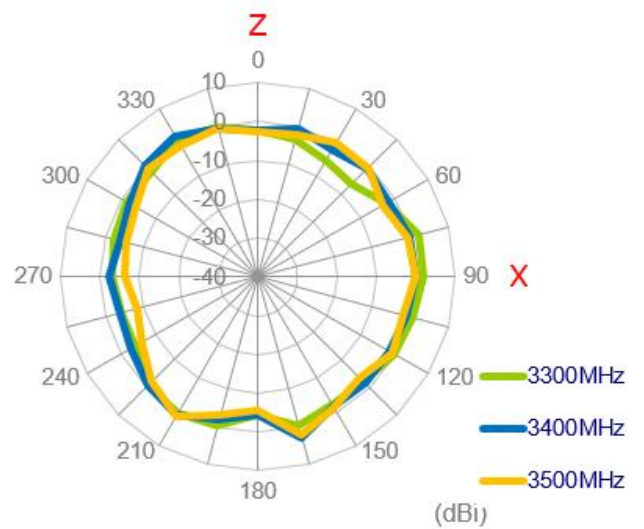
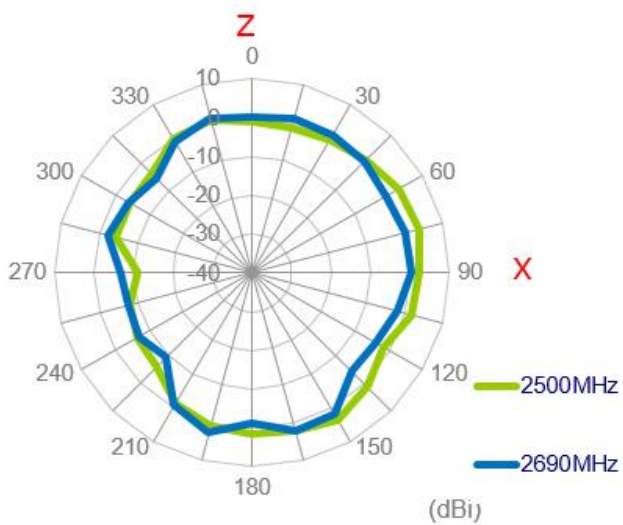
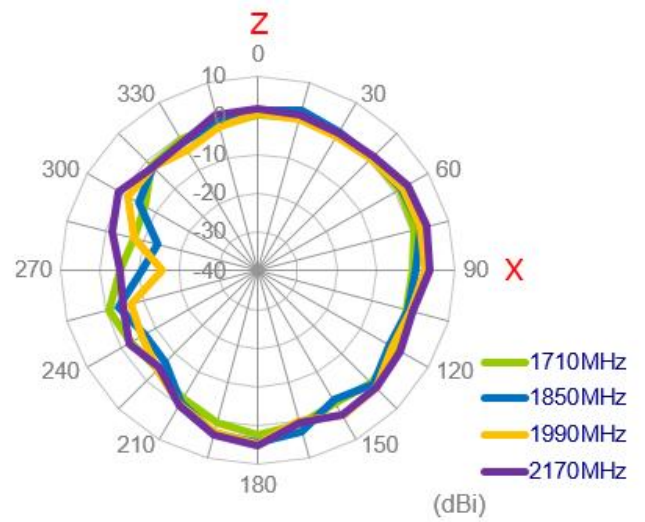
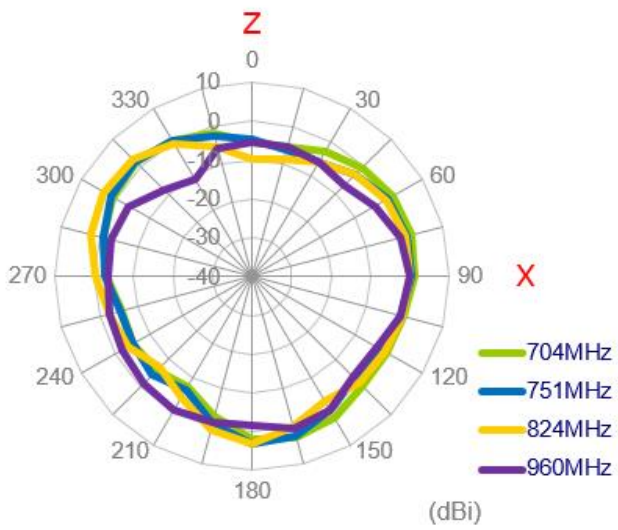

YZ Plane

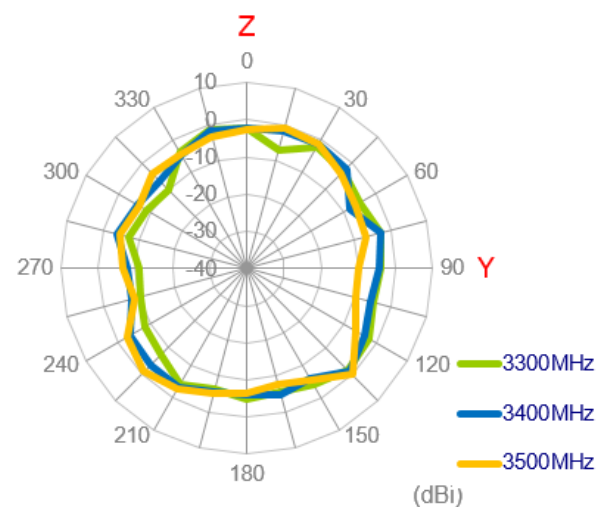
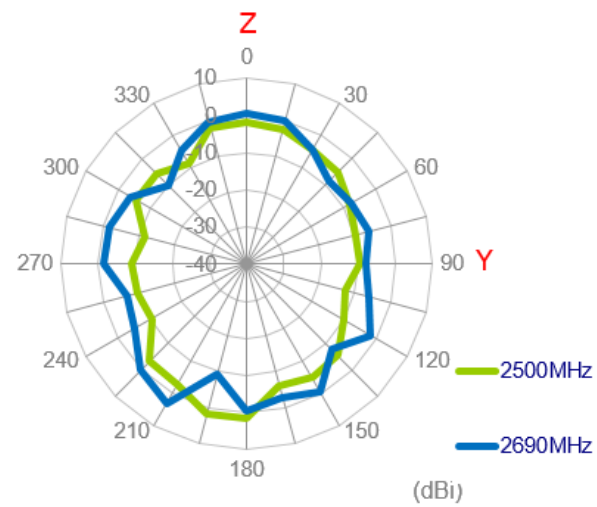
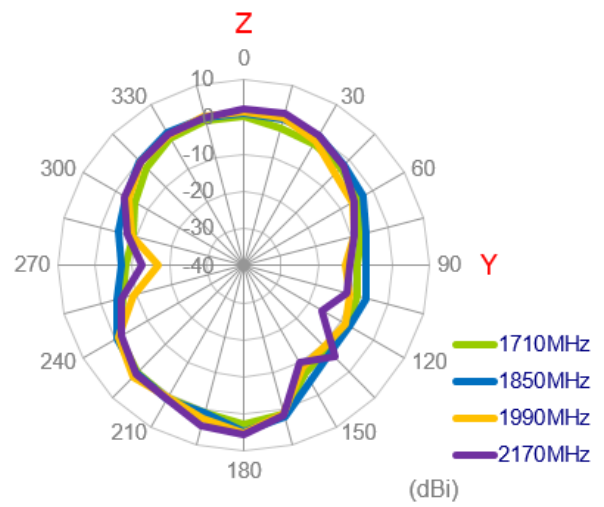
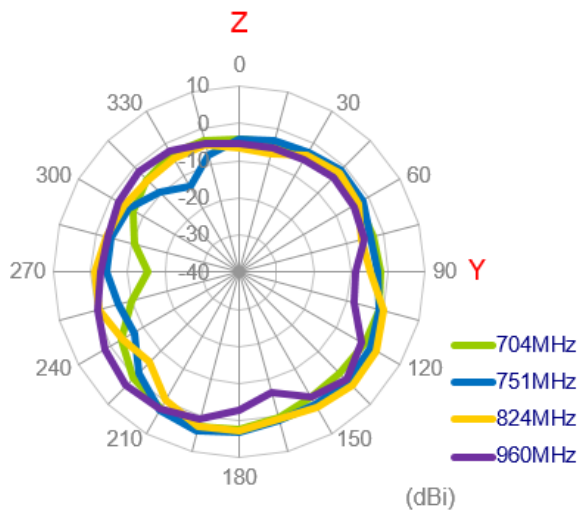

3.2.31 3D Radiation Patterns (LTE_MIMO1 with 1M cable length on ABS)

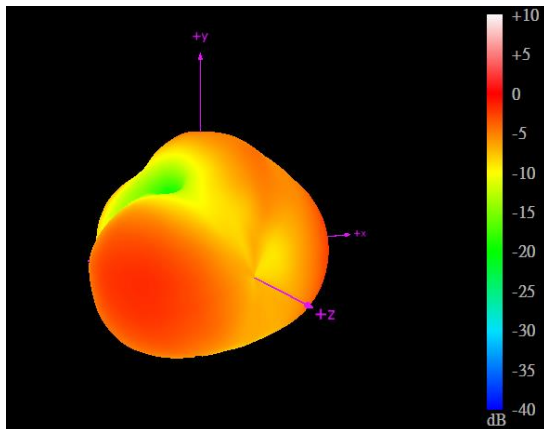

704MHz

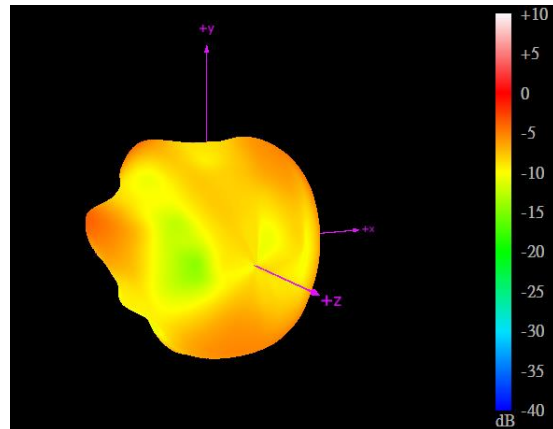

960MHz

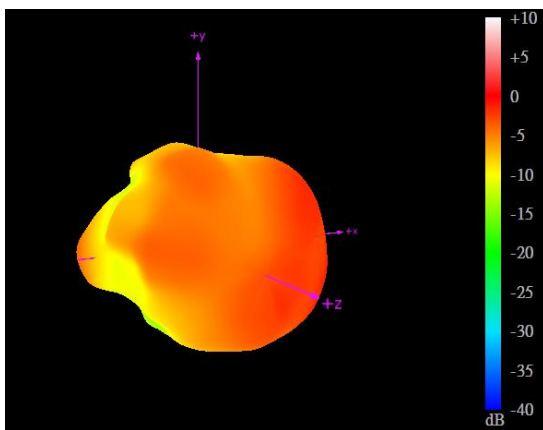

1710MHz

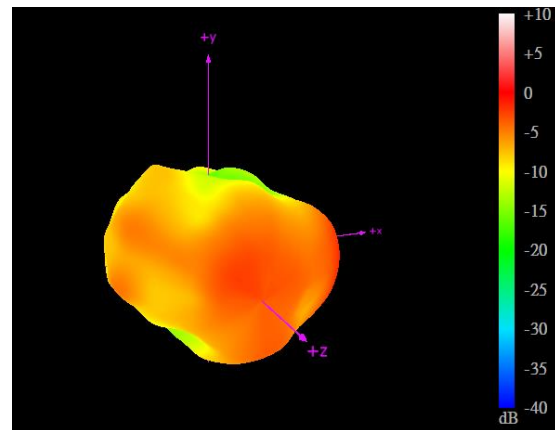

2170MHz

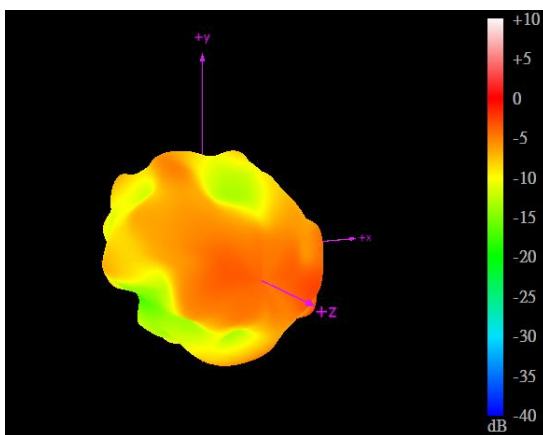

2690MHz

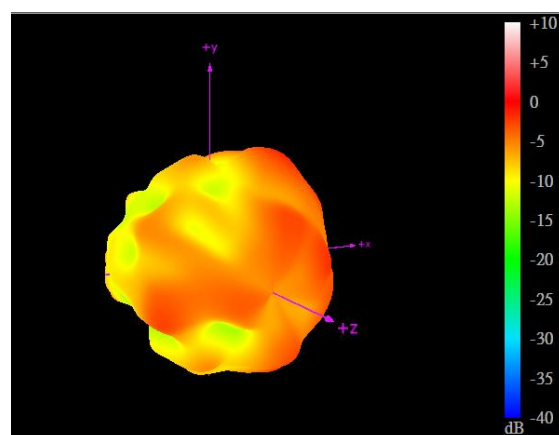

3500MHz

3.2.32 2D Radiation Patterns (LTE_MIMO2 with 1M cable length on ABS)

XY Plane

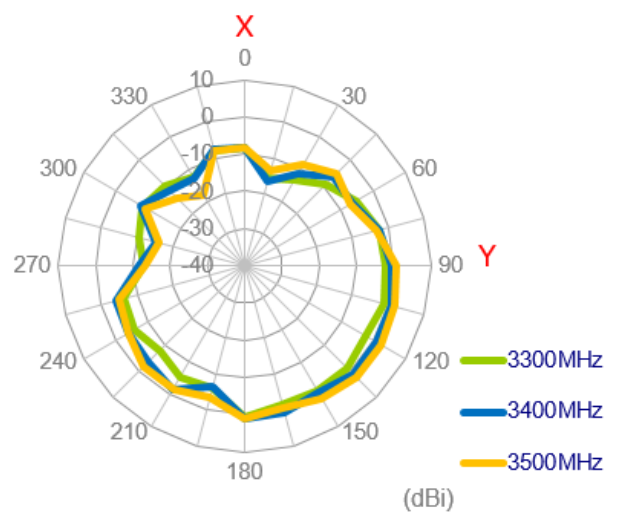
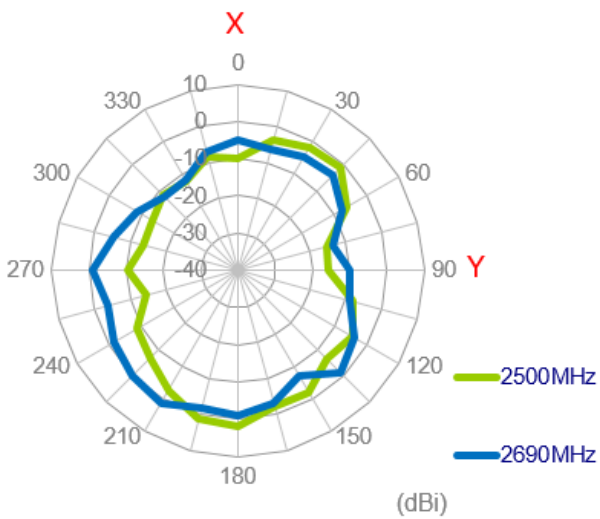
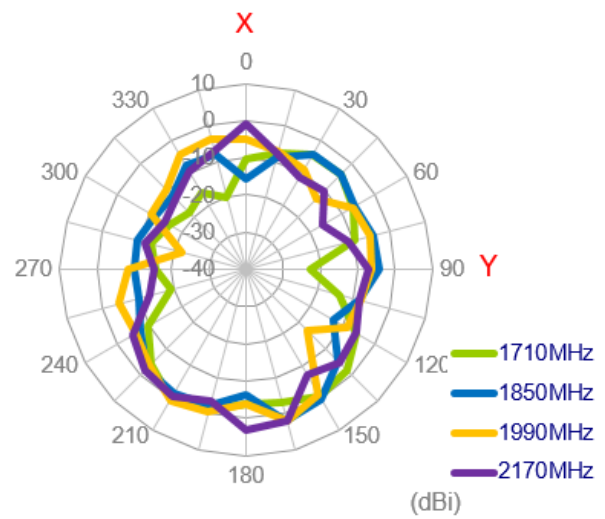
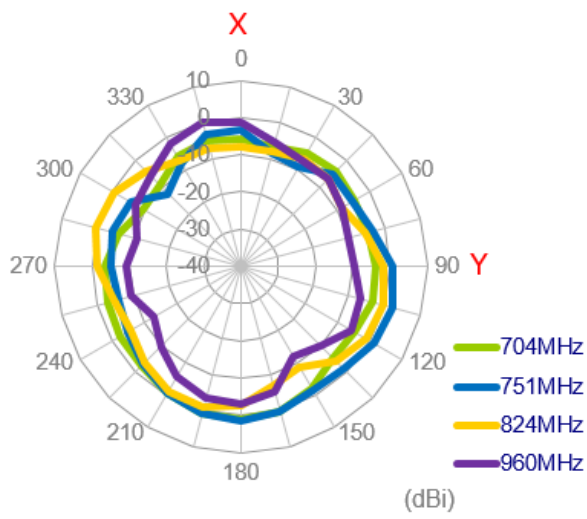

XZ Plane

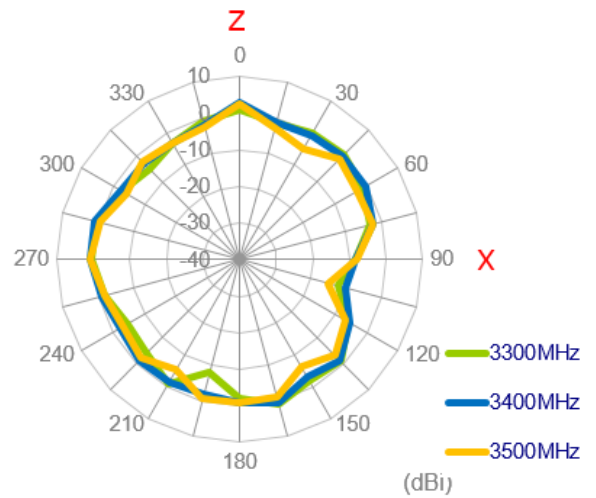
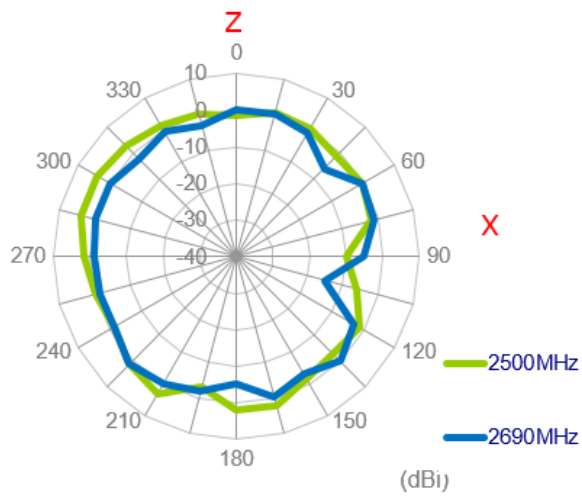
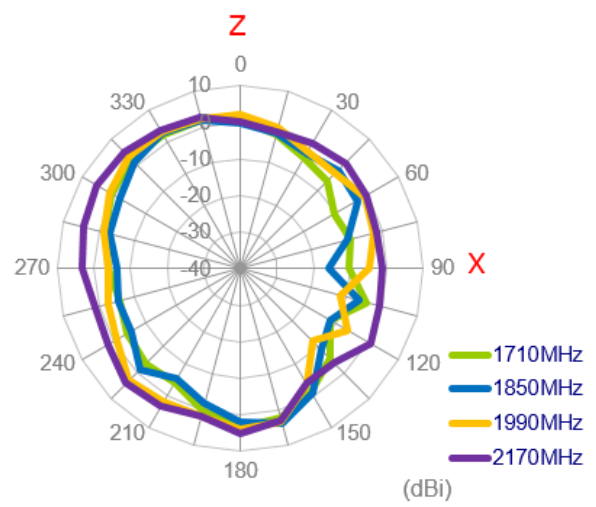
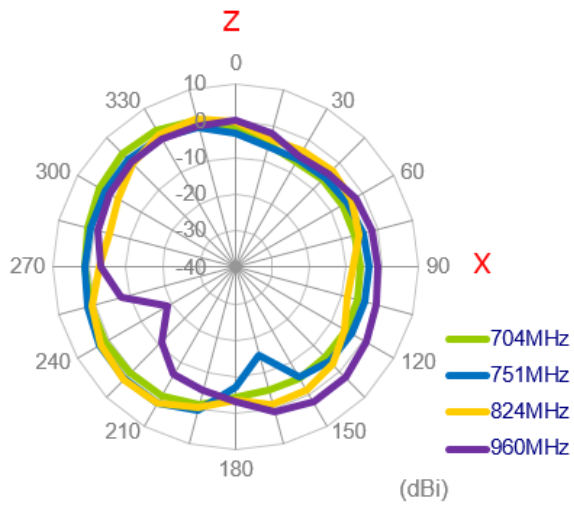

YZ Plane

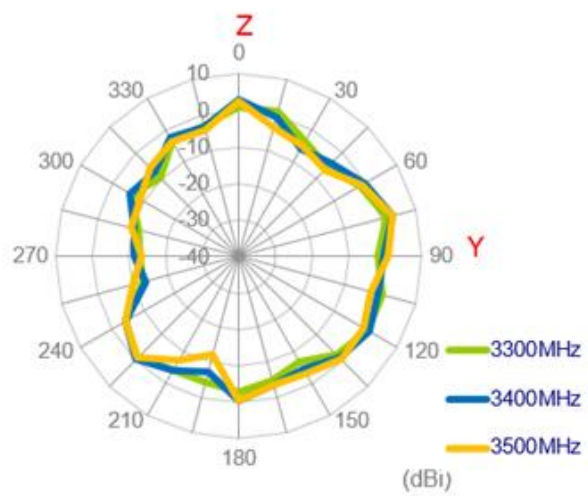
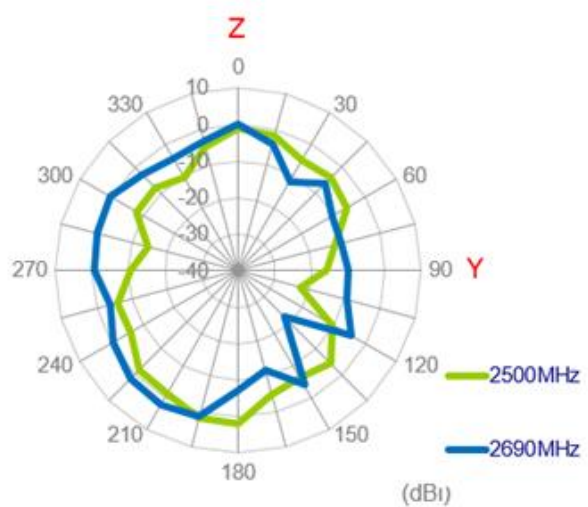
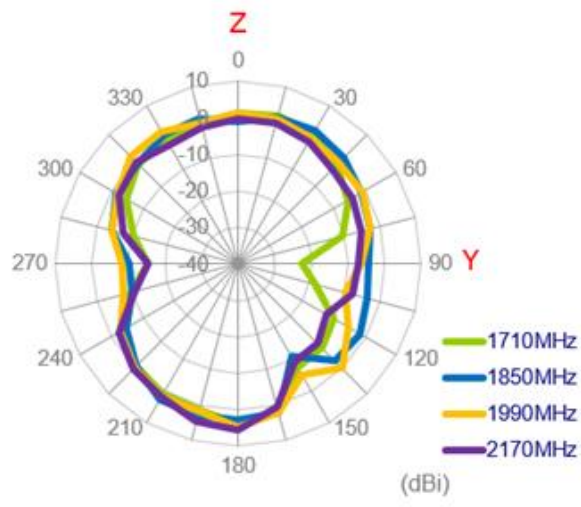
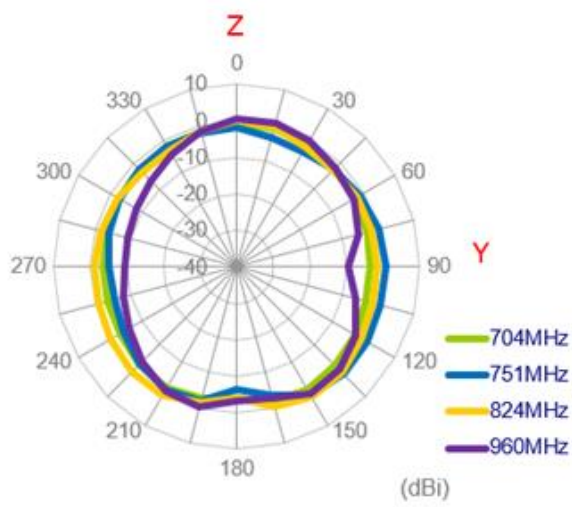

3.2.33 3D Radiation Patterns (LTE_MIMO2 with 1M cable length on ABS)

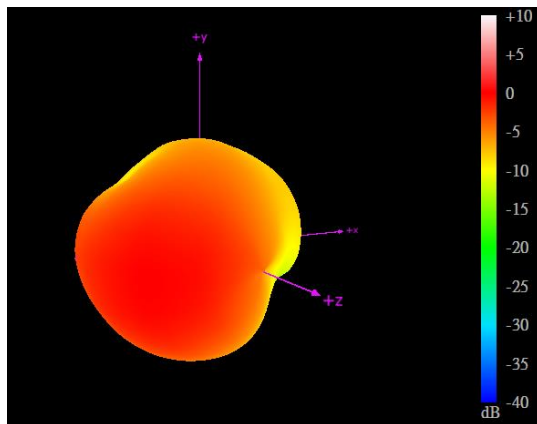

704MHz

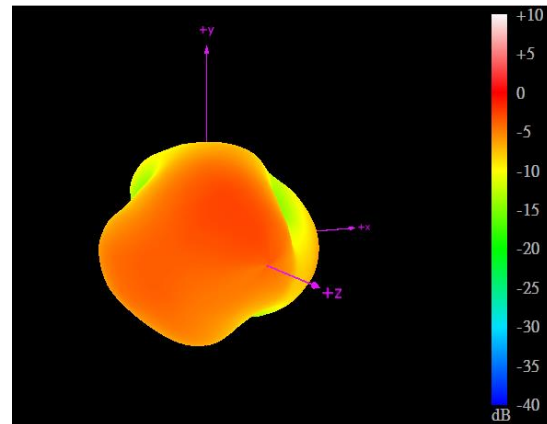

960MHz

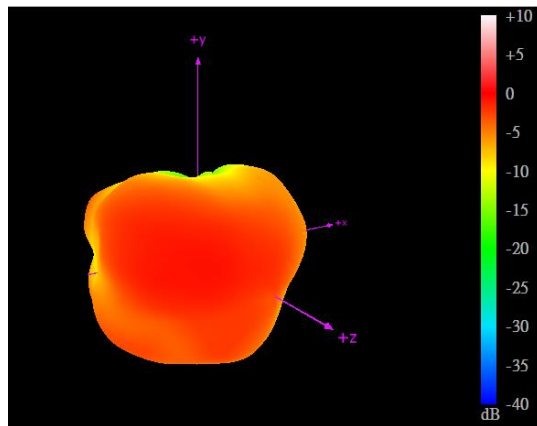

1710MHz

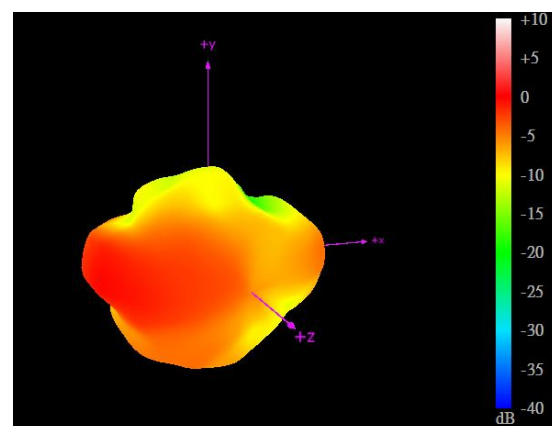

2170MHz

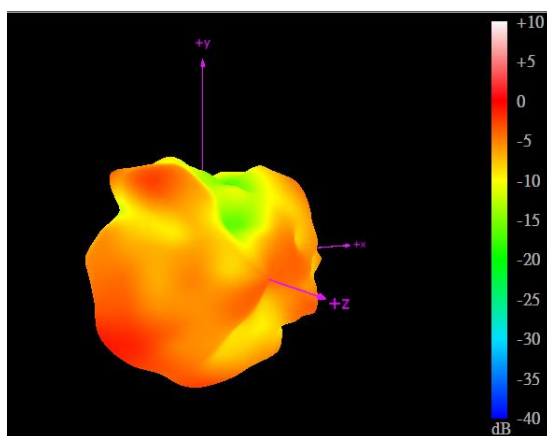

2690MHz

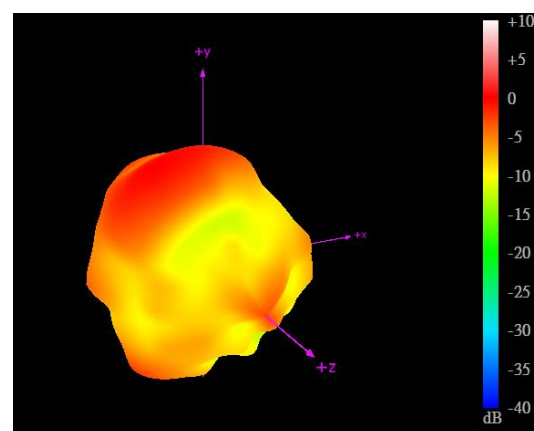

3500MHz

3.2.34 2D Radiation Patterns (Wi-Fi_MIMO1 with 1M cable length on ABS)

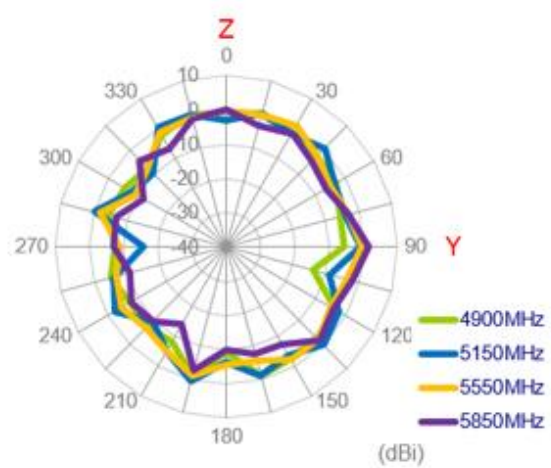
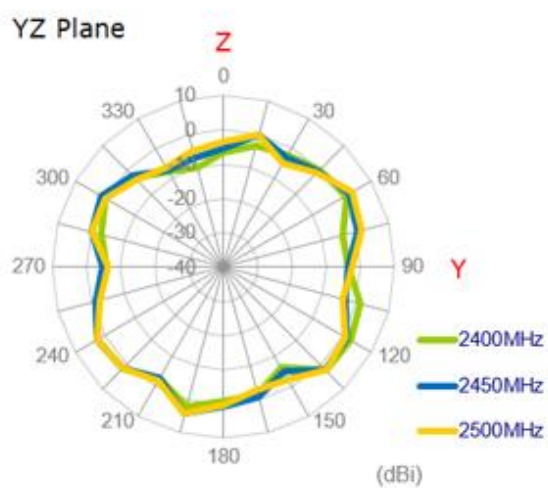
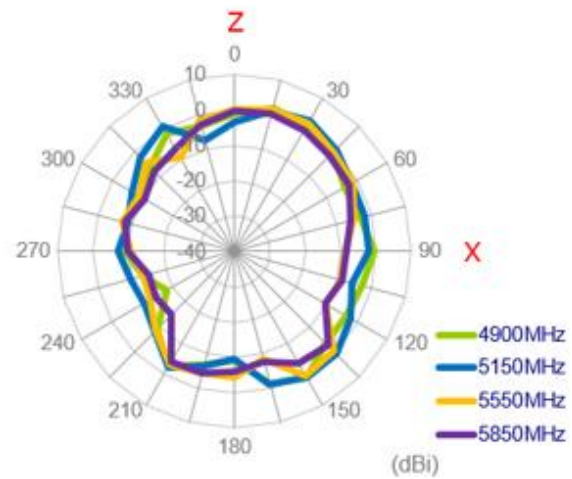
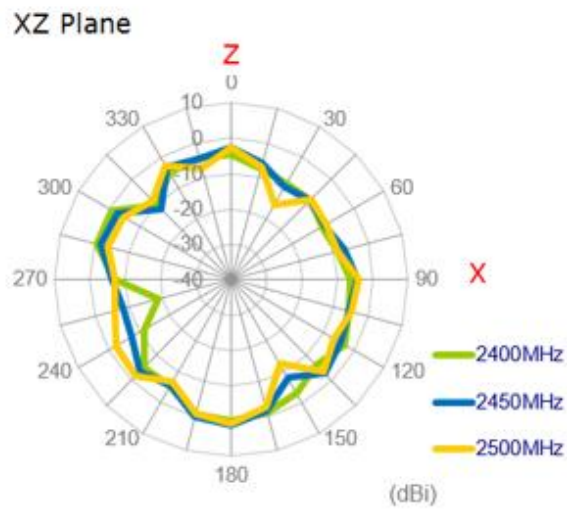
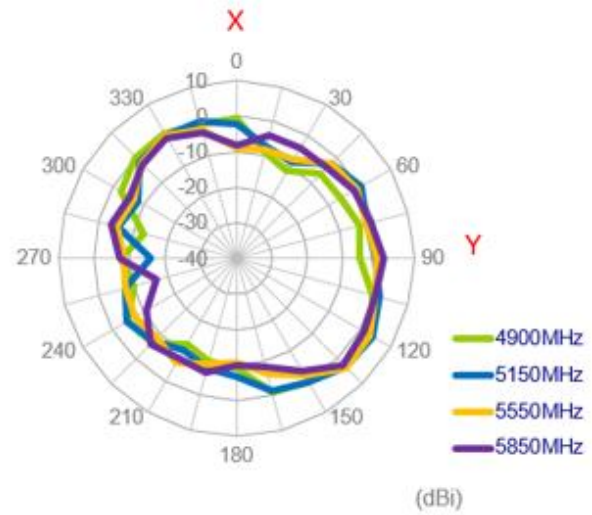
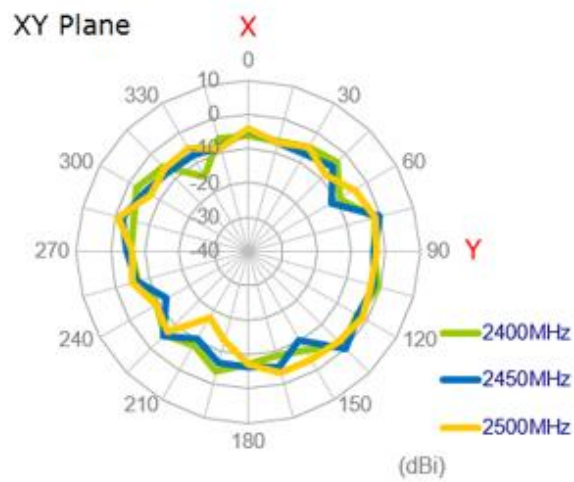

3.2.35 3D Radiation Patterns Pattern (Wi-Fi_MIMO1 with 1M cable length on ABS)

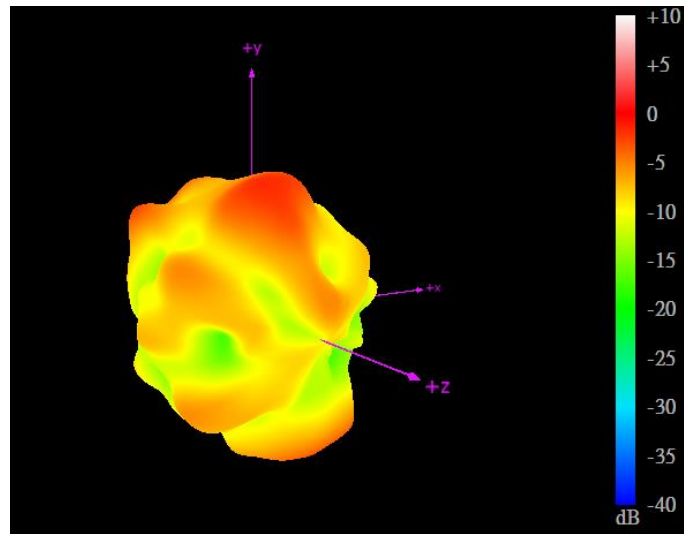

2450MHz

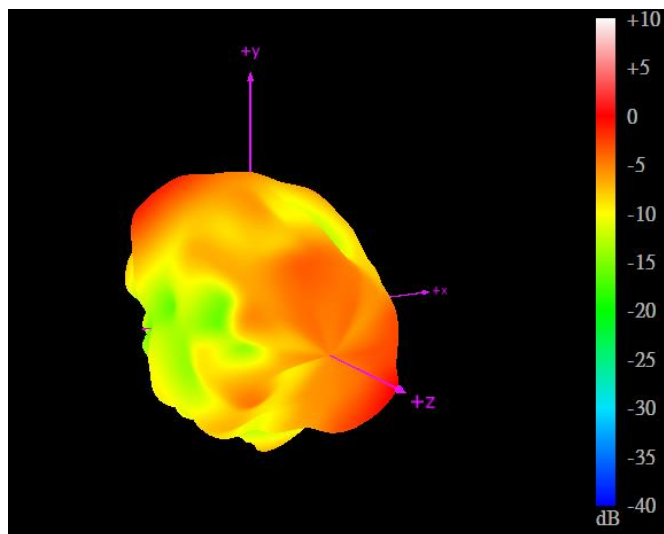

5550MHz

3.2.36 2D Radiation Patterns (LTE_MIMO1 with 1M cable length on ABS)

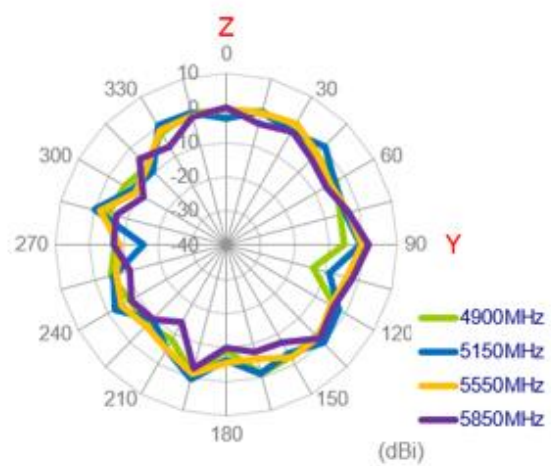
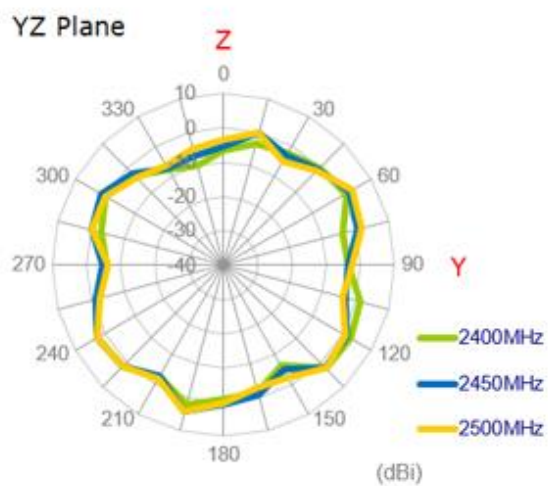
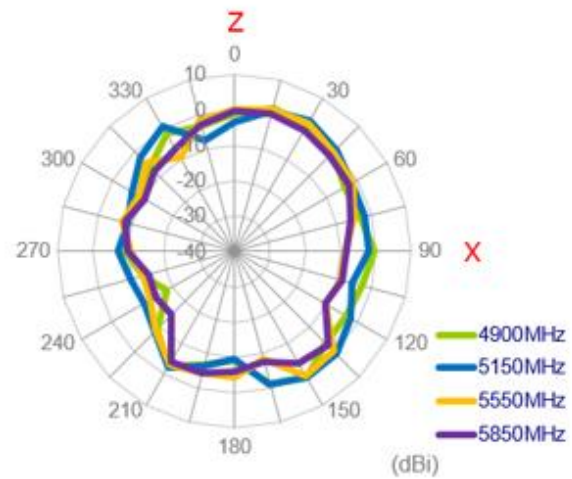
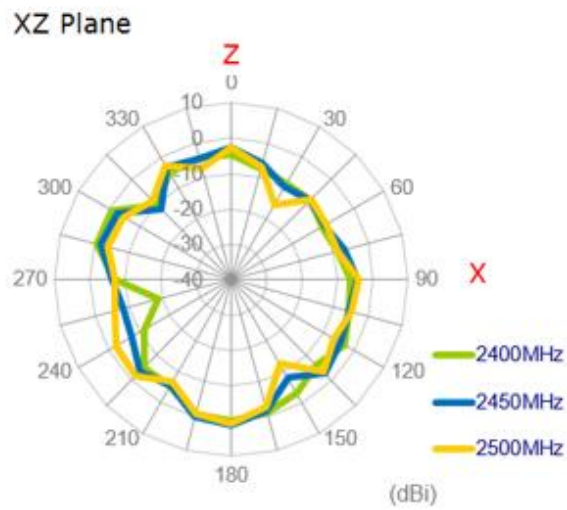
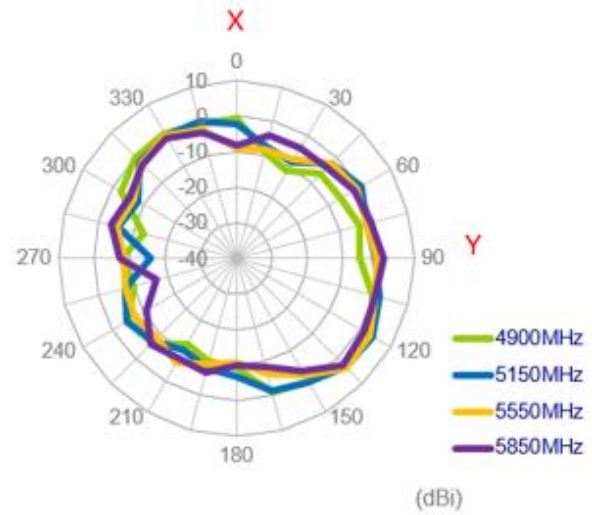
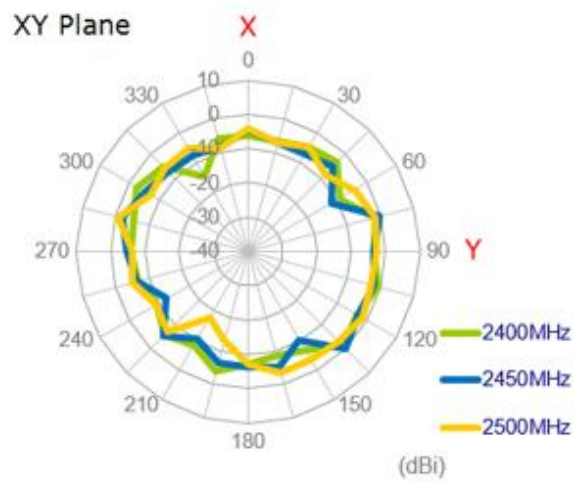

3.2.37 3D Radiation Patterns Pattern (Wi-Fi_MIMO2 with 1M cable length on ABS)

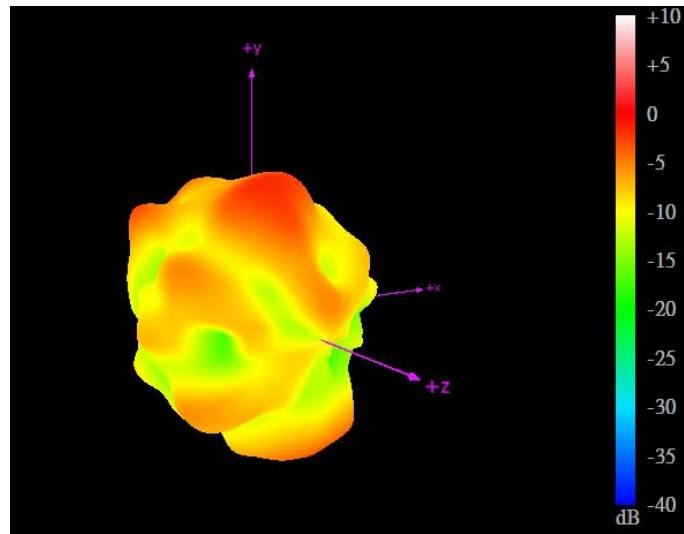

2450MHz

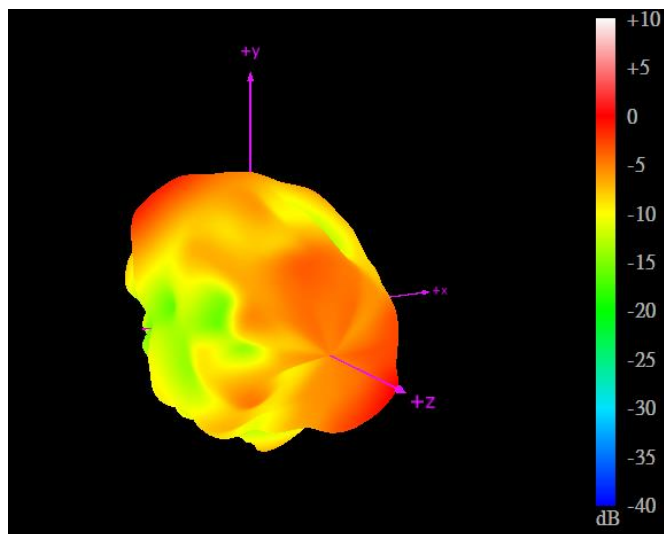

5550MHz

3.2.38 Test Setup for Antenna Radiation Pattern

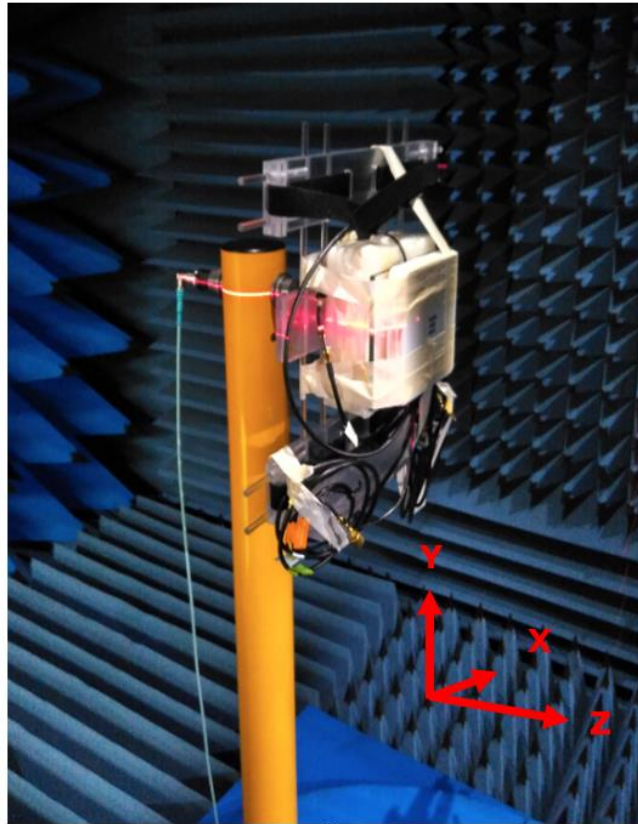

On glass

3.2.39 2D Radiation Patterns (LTE_MIMO1 with 1M cable length on glass)

XY Plane

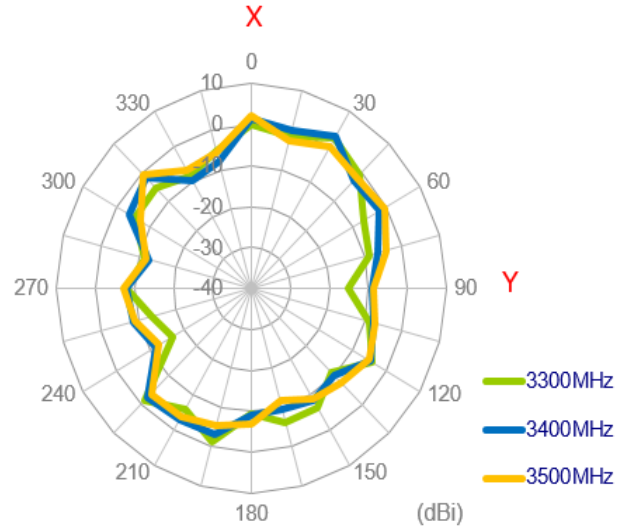
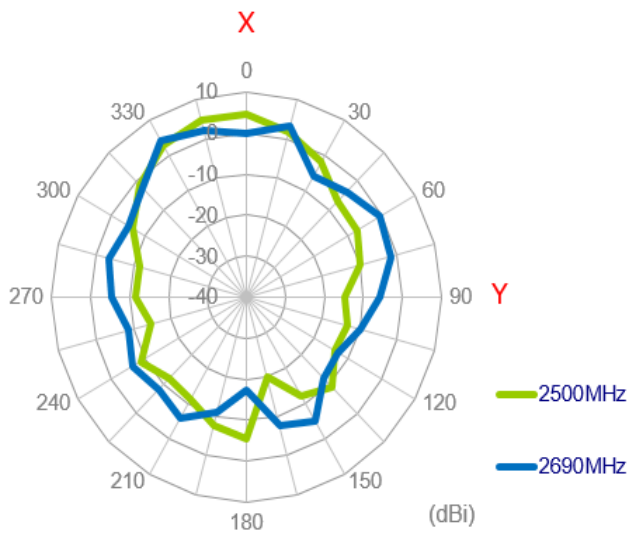
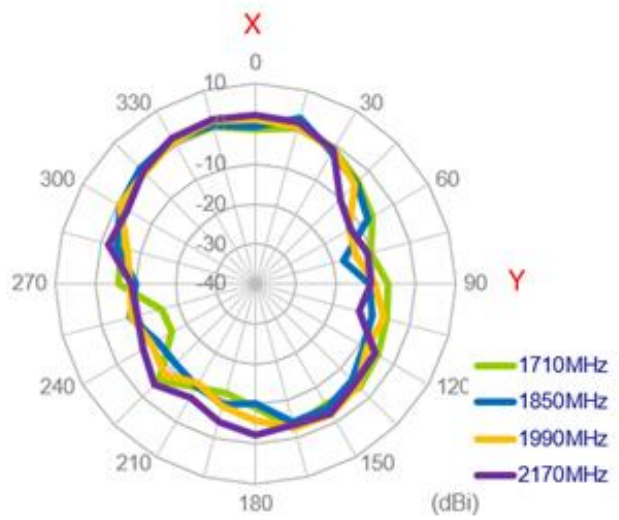
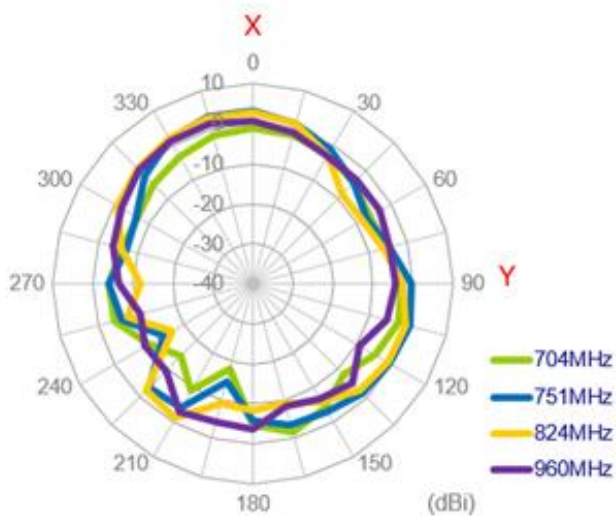

XZ Plane

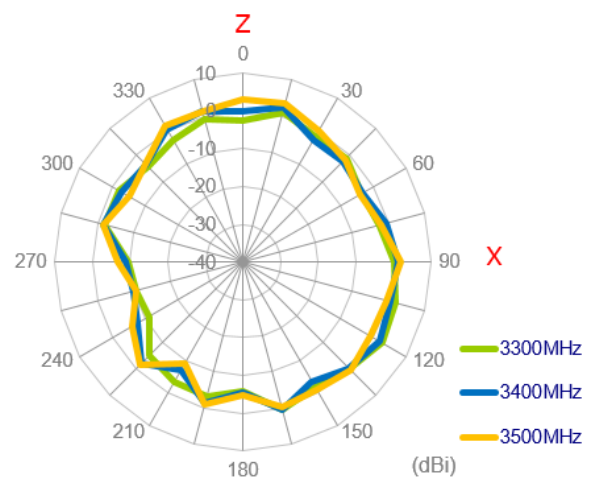
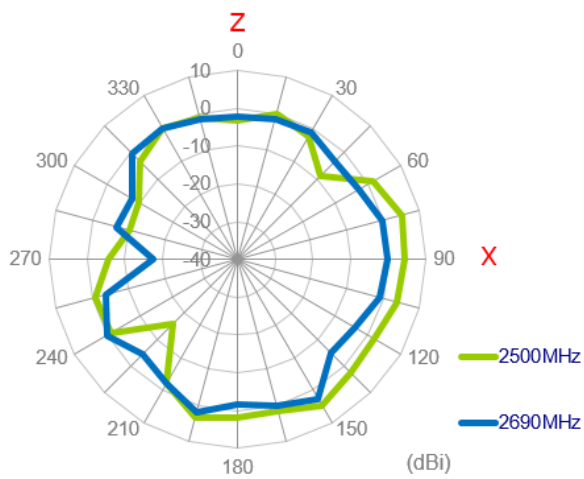
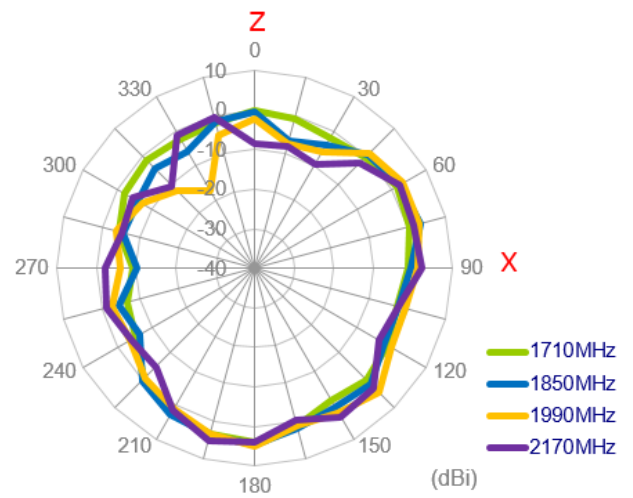
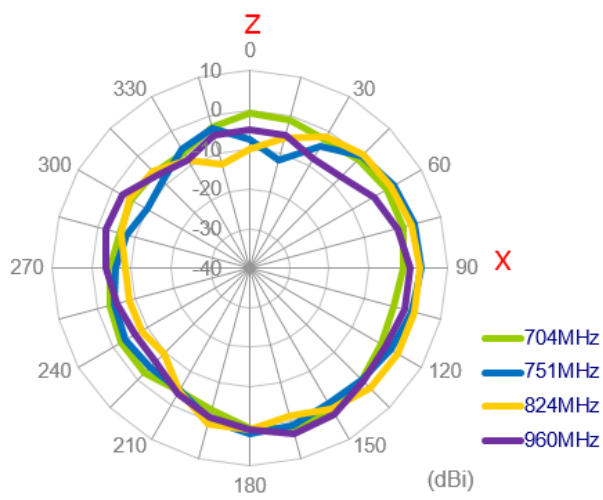

YZ Plane

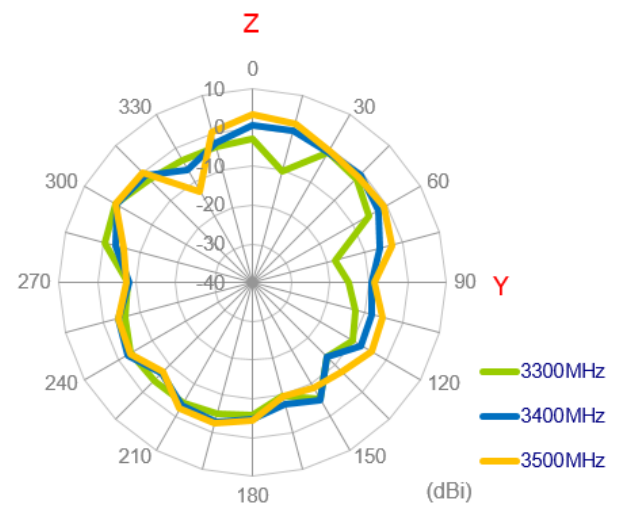
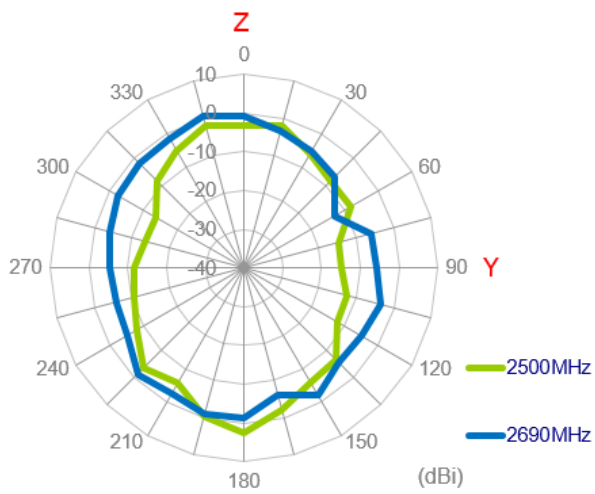
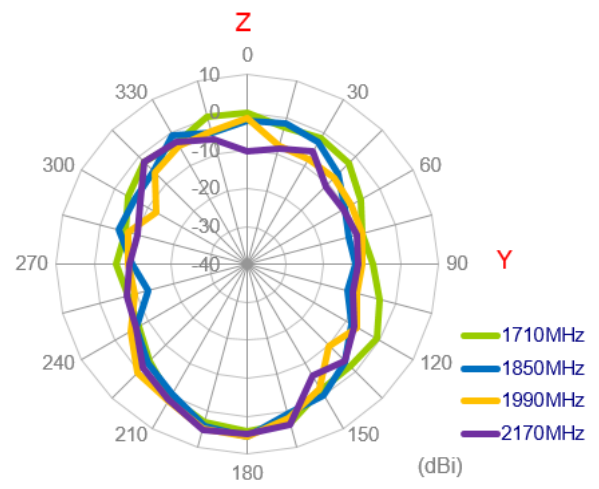
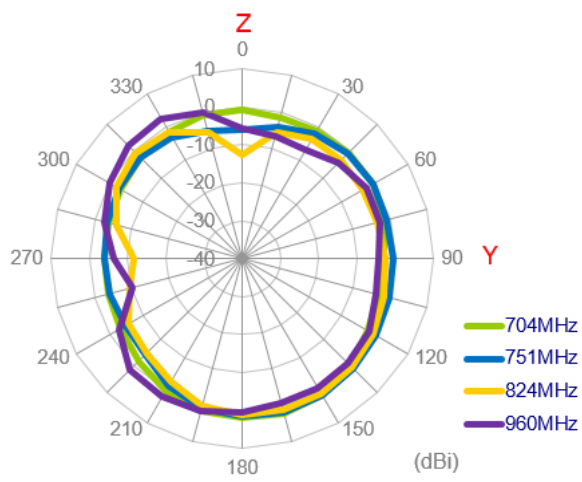

3.2.40 3D Radiation Patterns (LTE_MIMO1 with 1M cable length on grass)

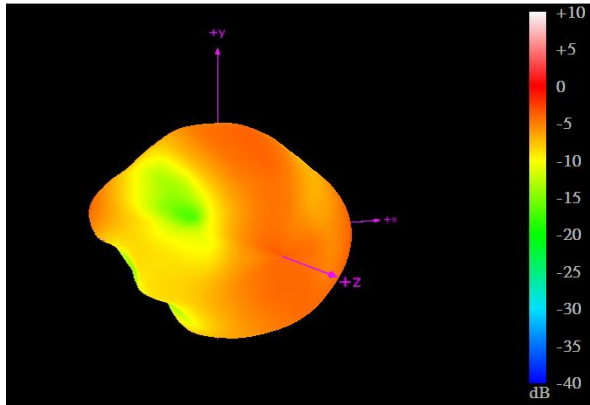

704MHz

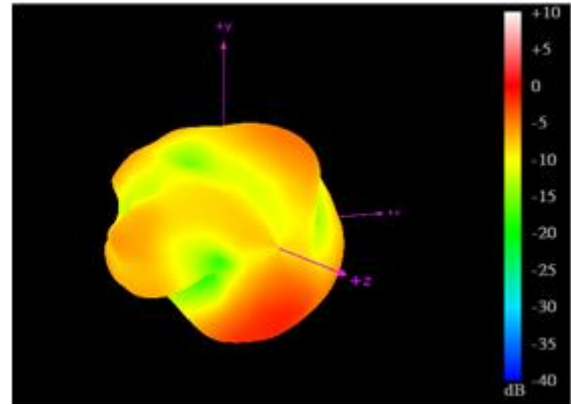

960MHz

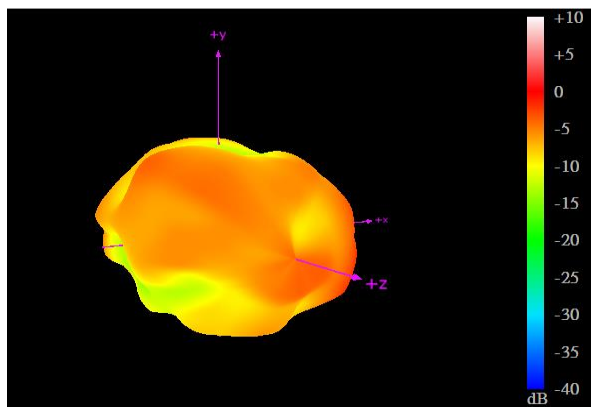

1710MHz

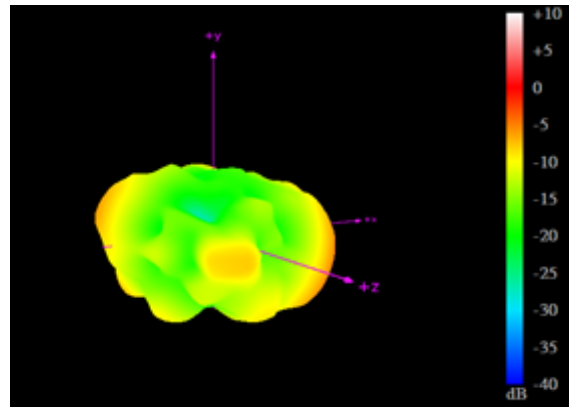

2170MHz

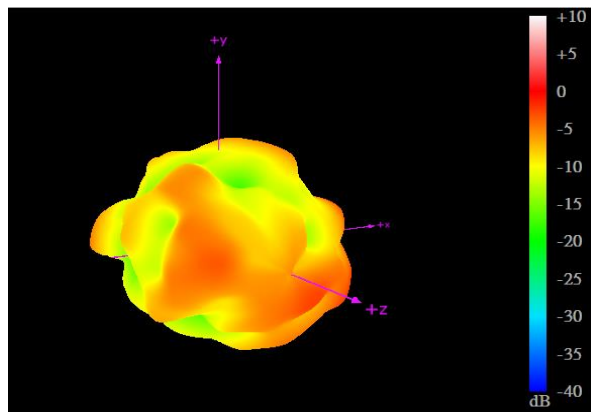

2690MHz

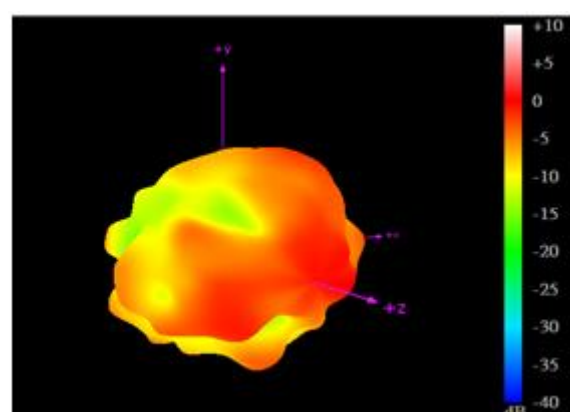

3500MHz

3.2.41 2D Radiation Patterns (LTE_MIMO2 with 1M cable length on glass)

XY Plane

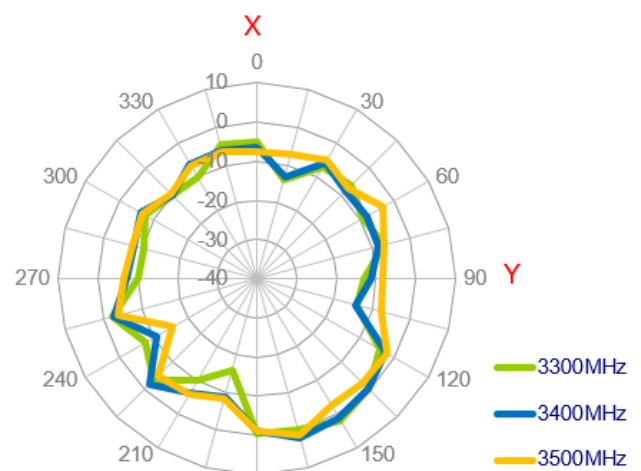
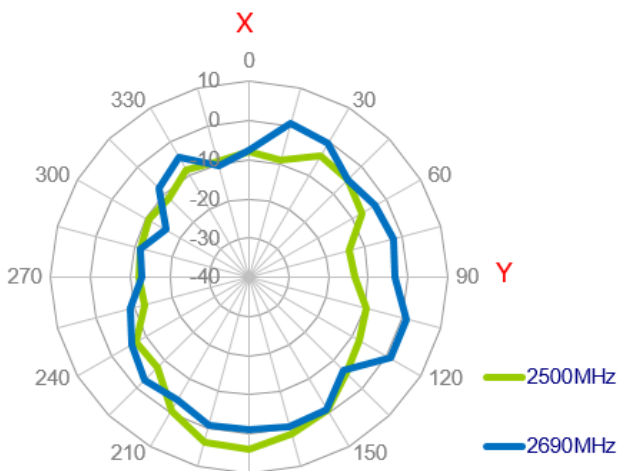
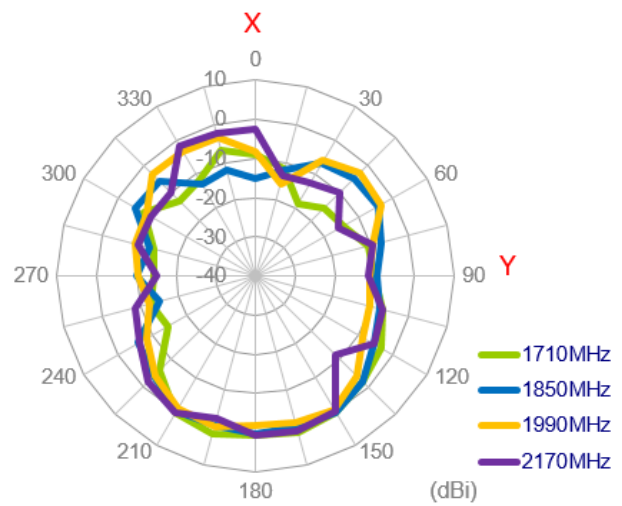
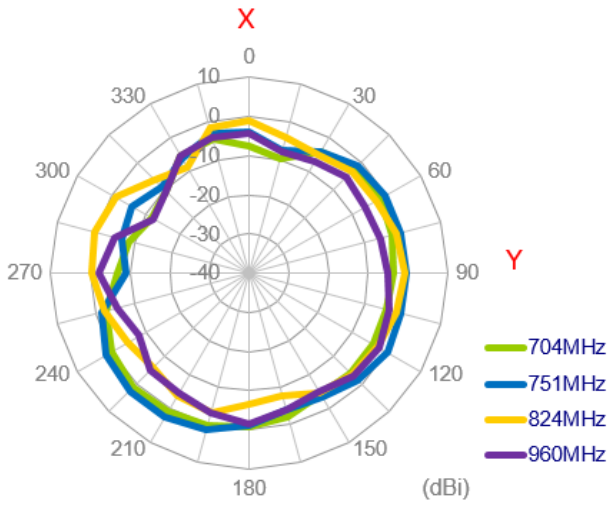

XZ Plane

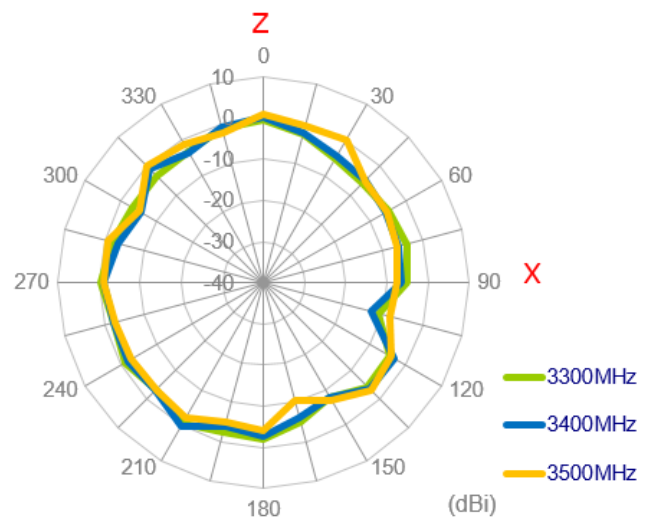
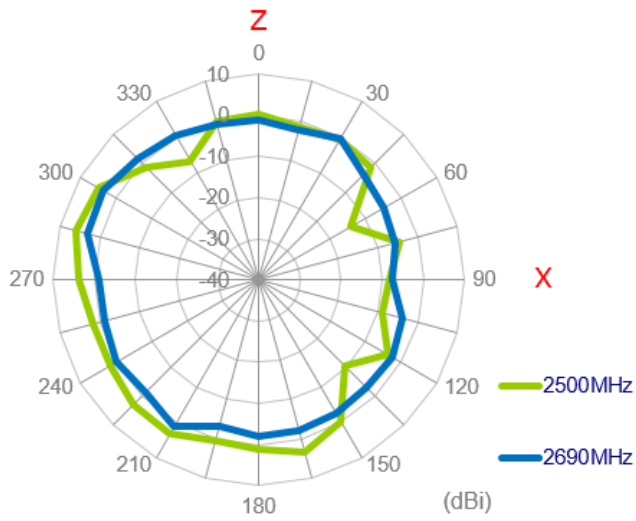
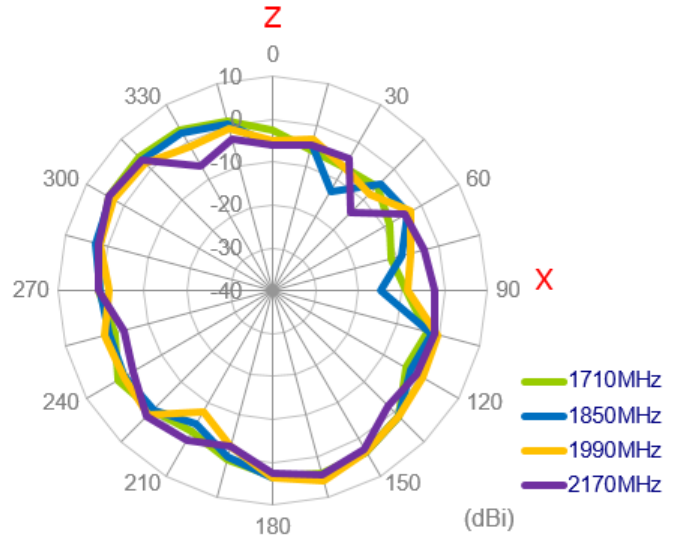
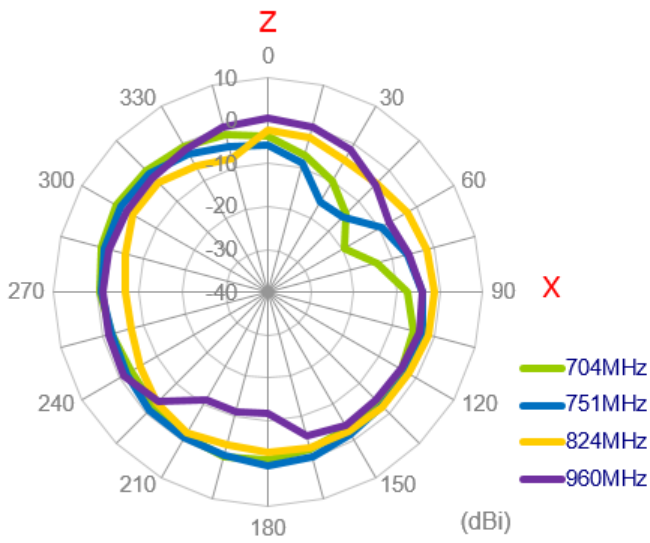

YZ Plane

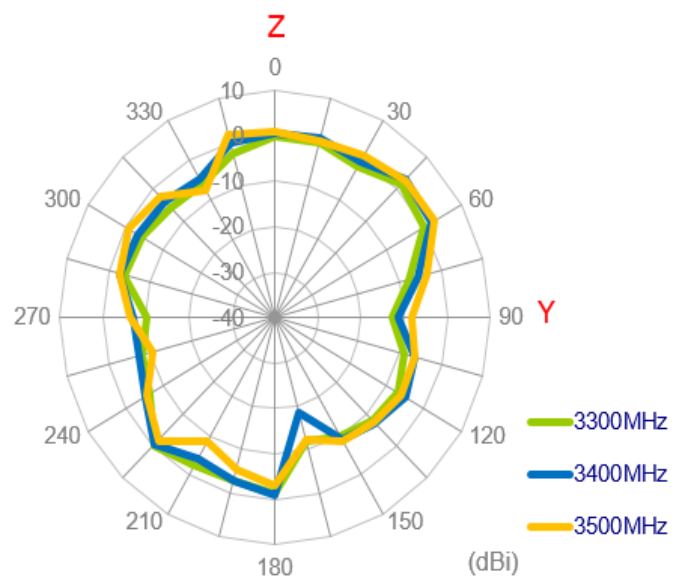
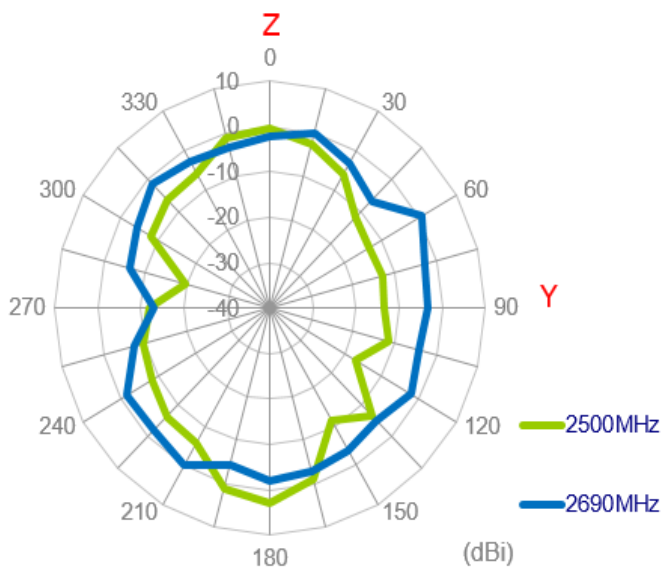
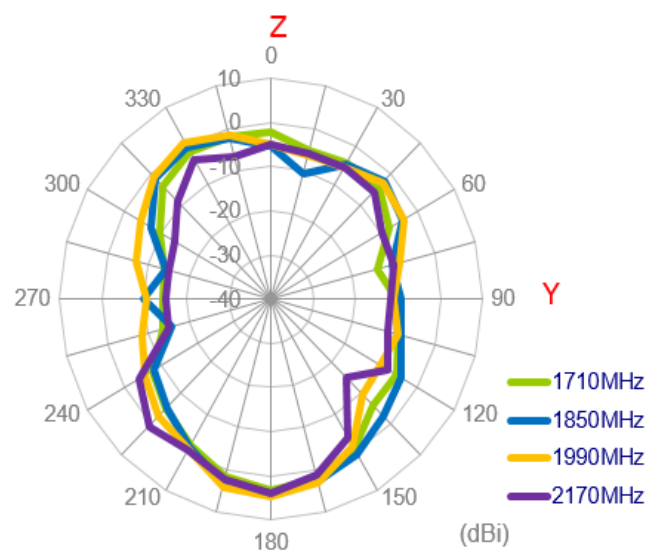
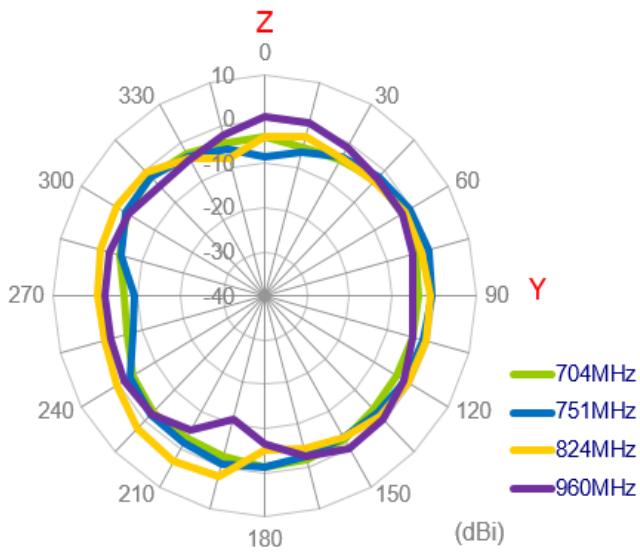

3.2.42 3D Radiation Patterns (LTE_MIMO2 with 1M cable length on grass)

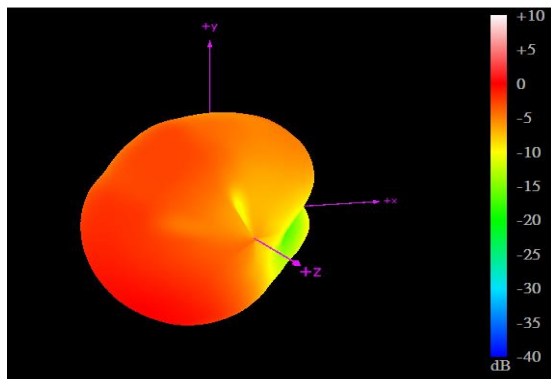

704MHz

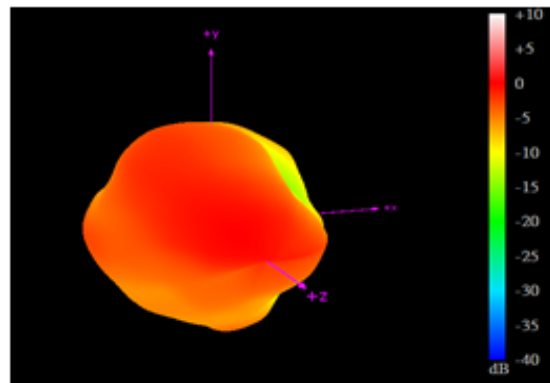

960MHz

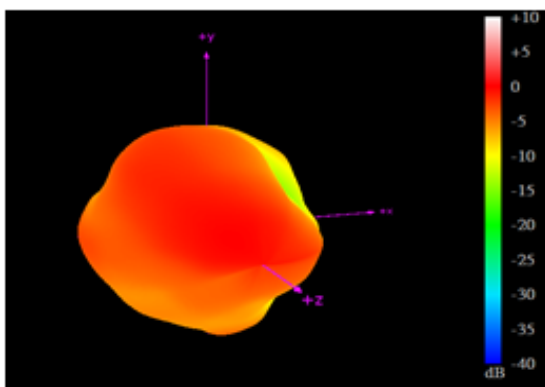

1710MHz

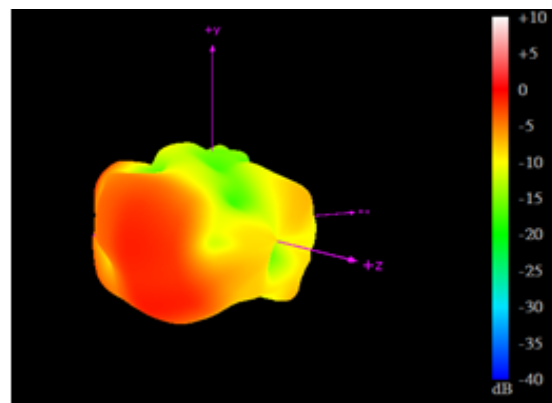

2170MHz

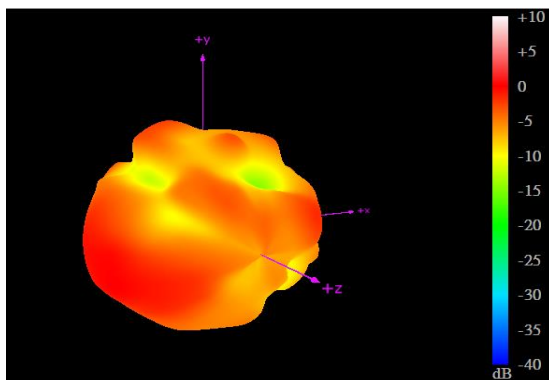

2690MHz

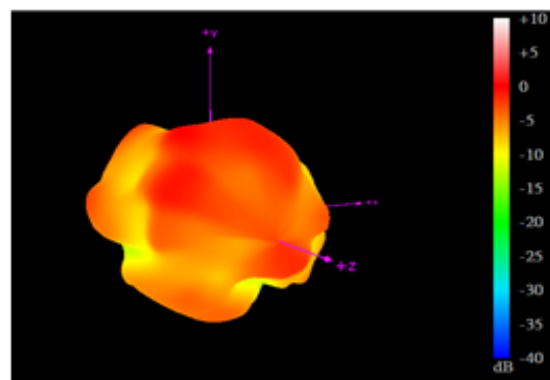

3500MHz

3.2.43 2D Radiation Patterns (Wi-Fi_MIMO1 with 1M cable length on glass)

XY Plane

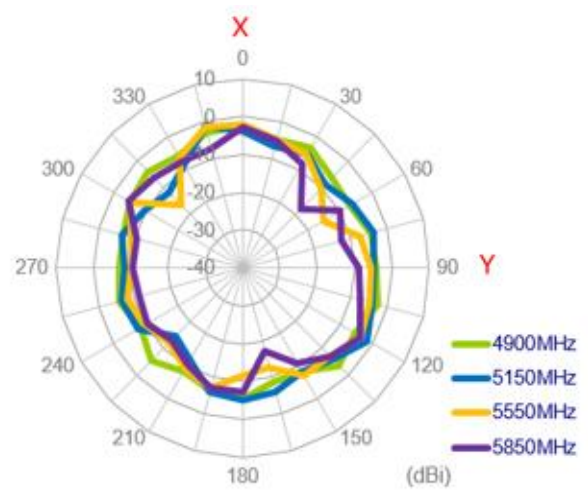
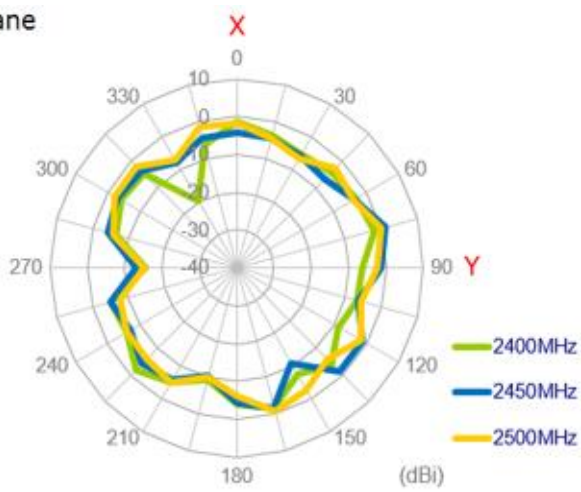

XZ Plane

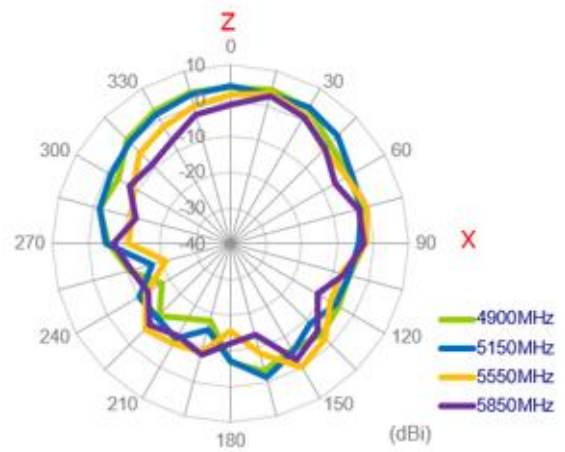
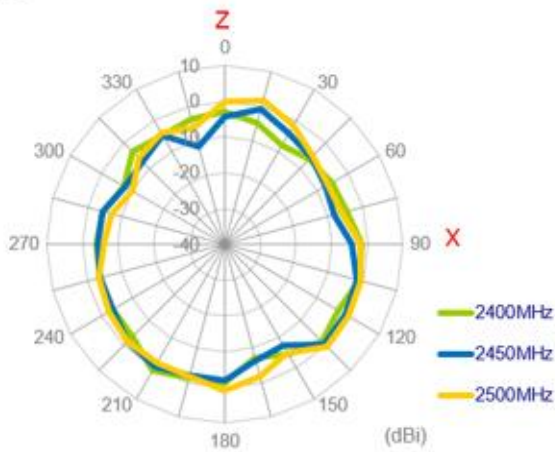

YZ Plane

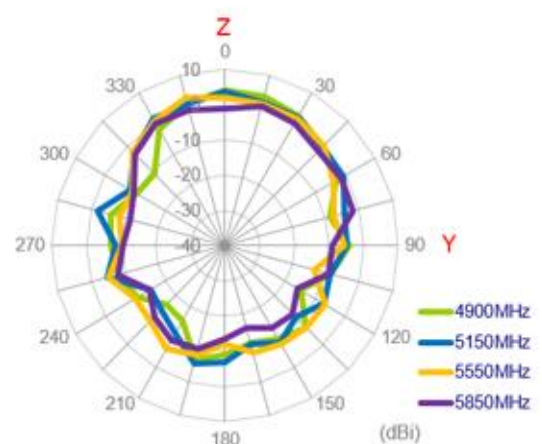
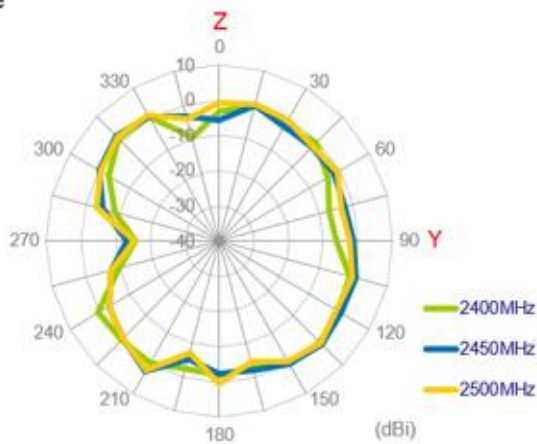

3.2.44 3D Radiation Patterns Pattern (Wi-Fi_MIMO1 with 1M cable length on glass)

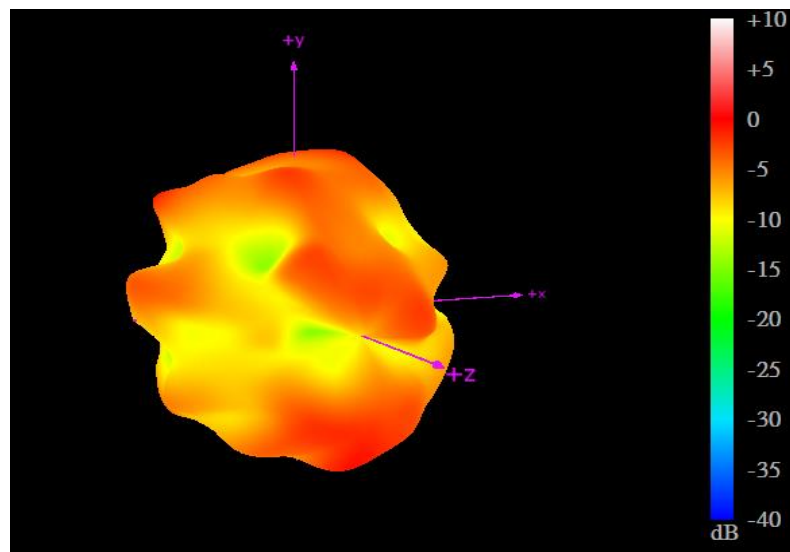

2450MHz

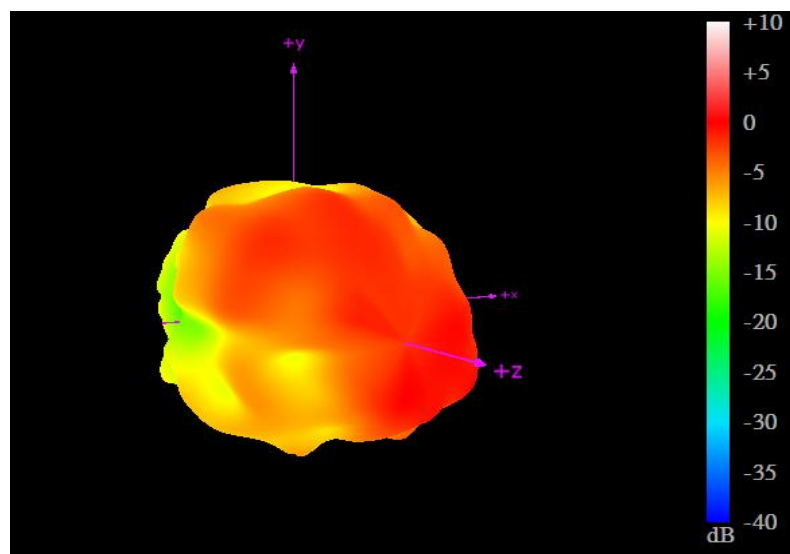

5550MHz

3.2.45 2D Radiation Patterns (Wi-Fi_MIMO2 with 3M cable length on glass)

XY Plane

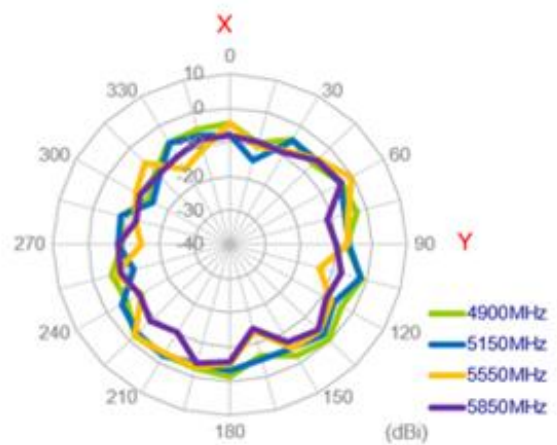
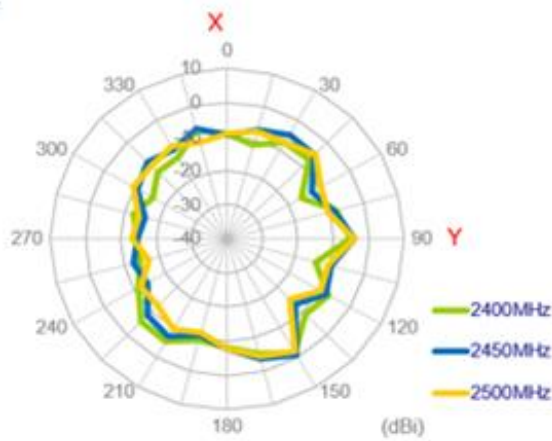

XZ Panel

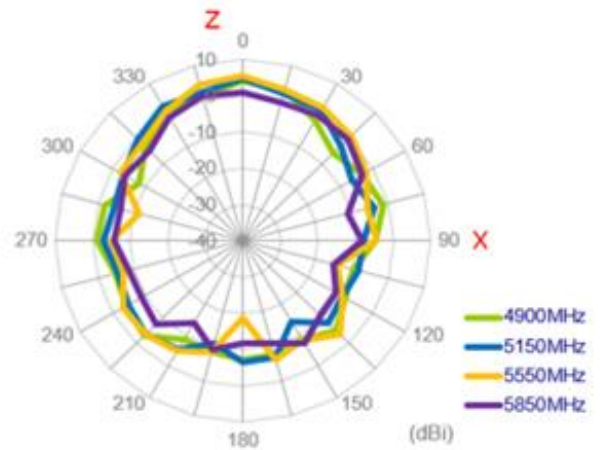
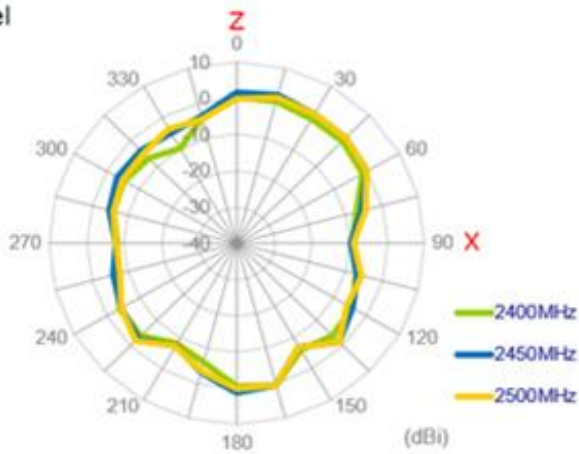

YZ Plane

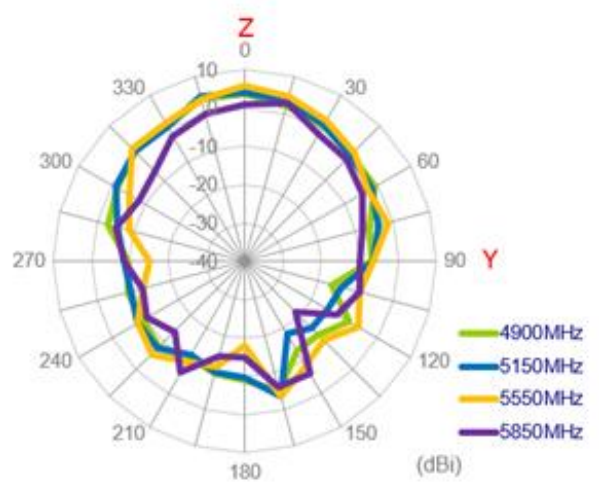
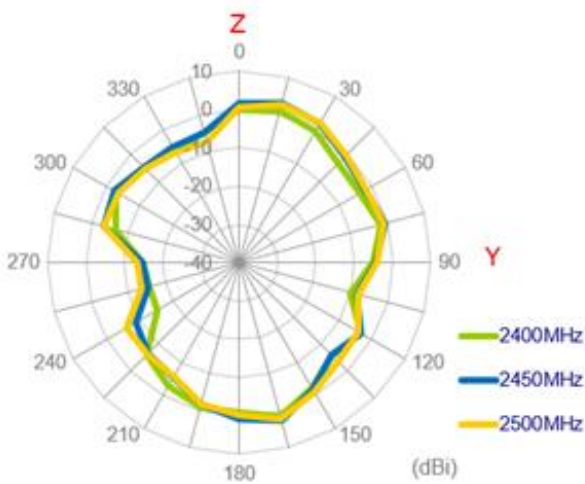

3.2.46 3D Radiation Patterns Pattern (Wi-Fi_MIMO2 with 1M cable length on glass)

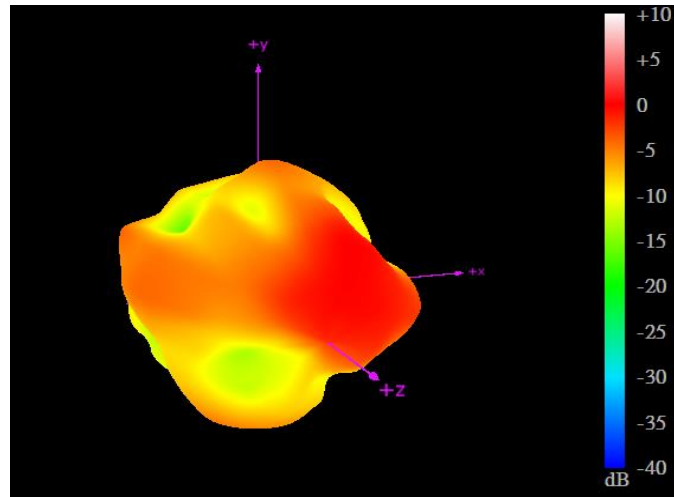

2450MHz

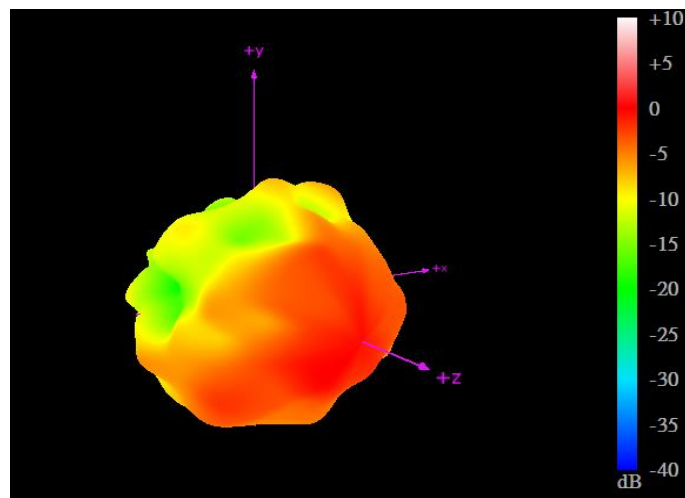

5550MHz

3.2.47 Test Setup for Antenna Radiation Pattern

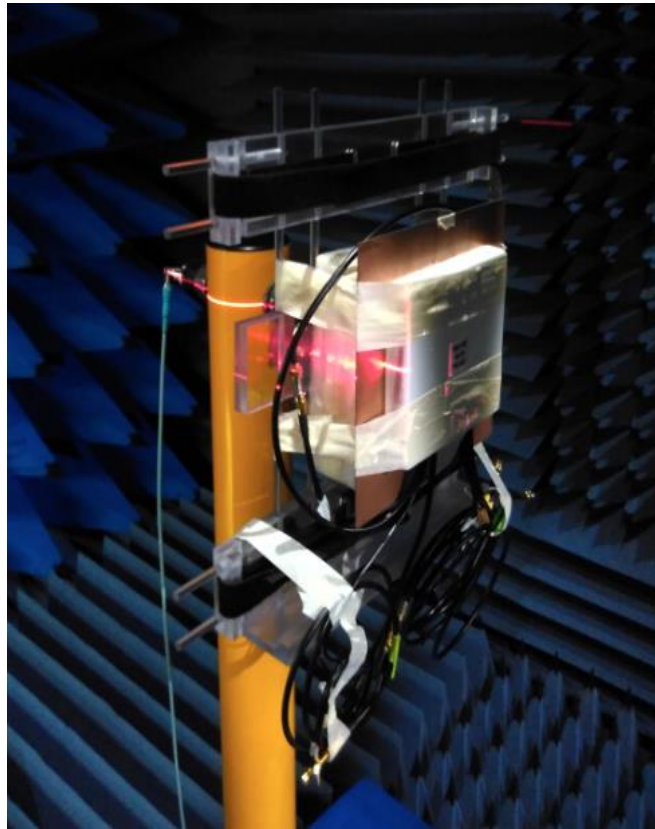

On metal

3.2.48 2D Radiation Patterns (LTE_MIMO1 with 1M cable length on metal)

XY Plane

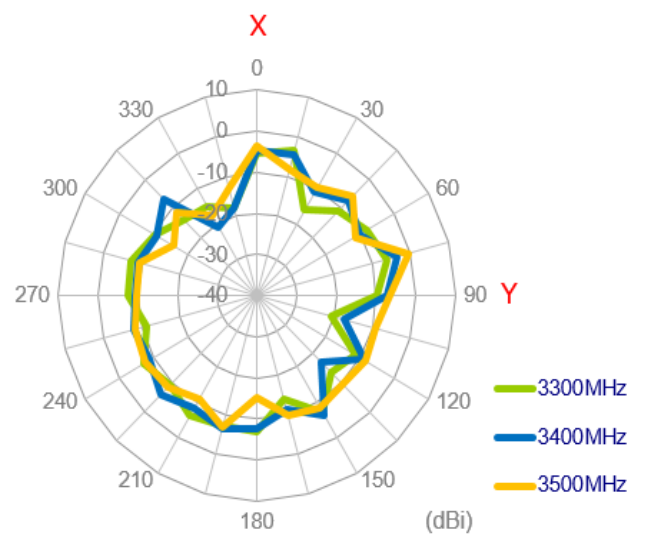
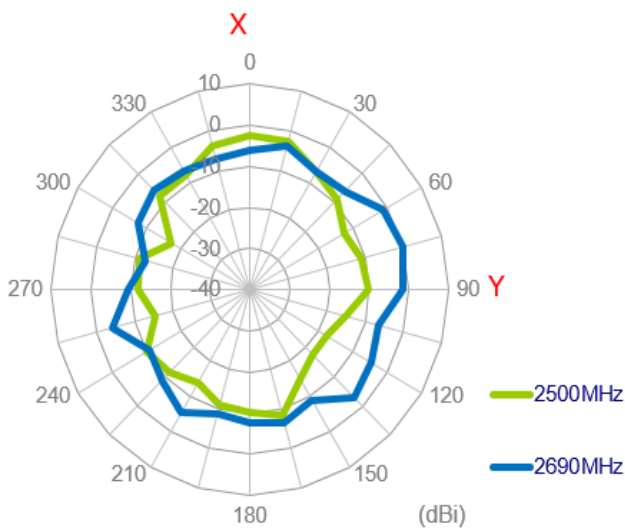
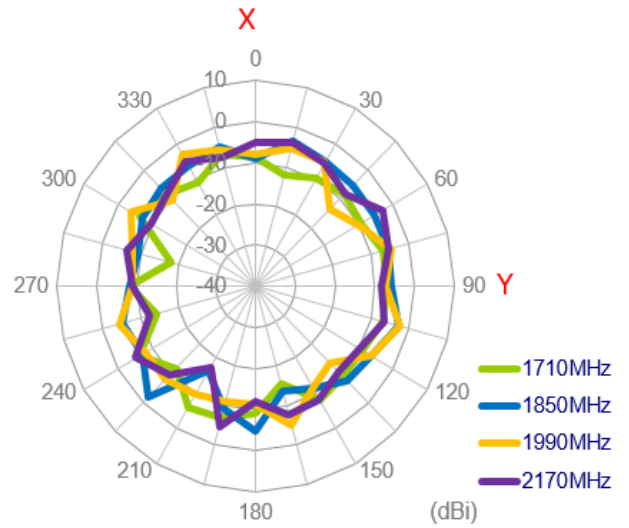
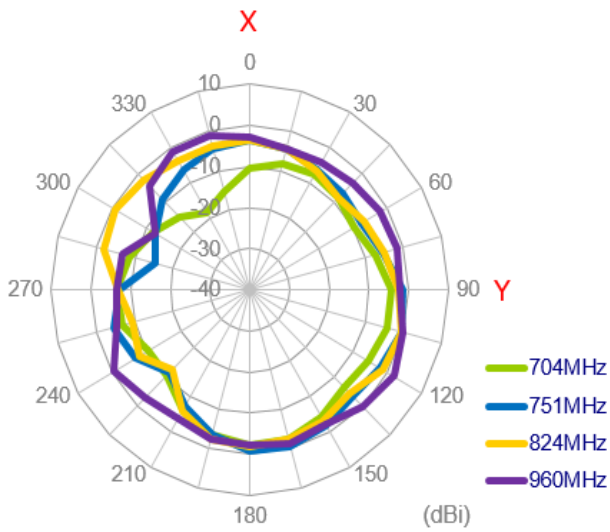

XZ Plane

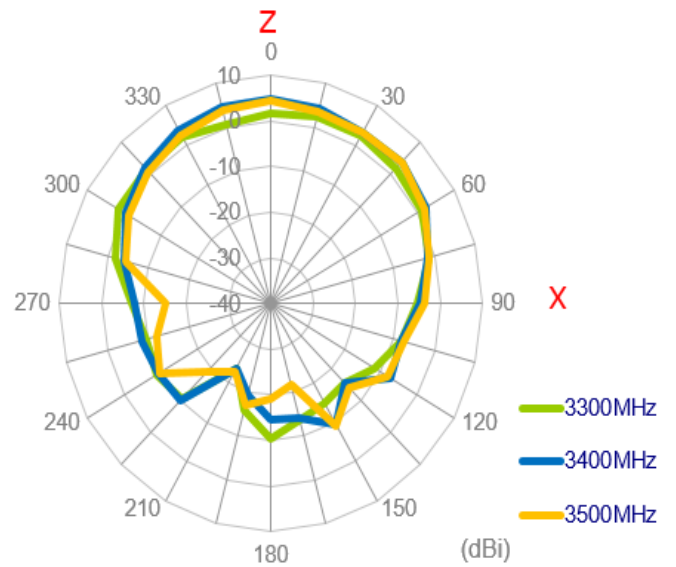
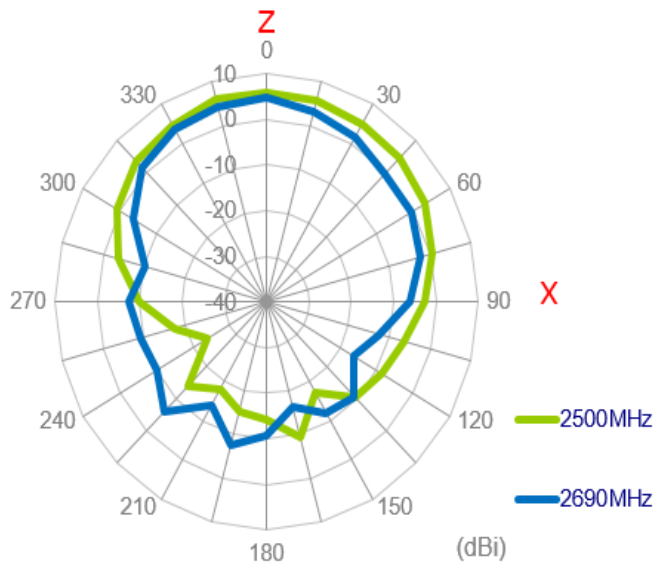
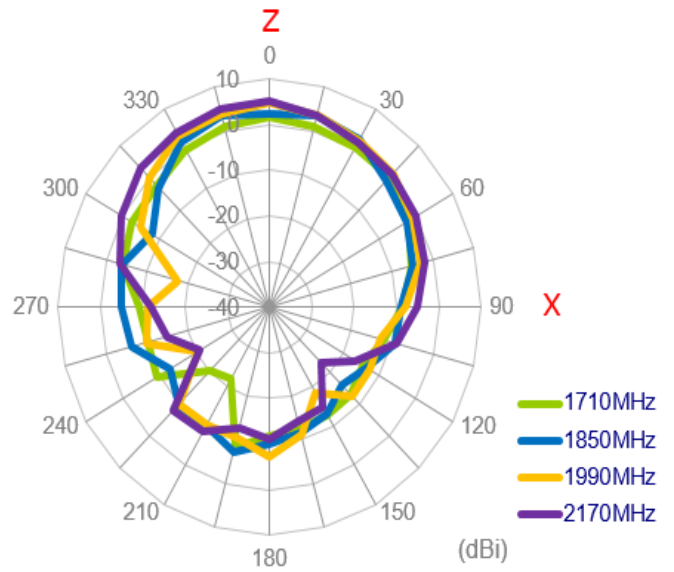
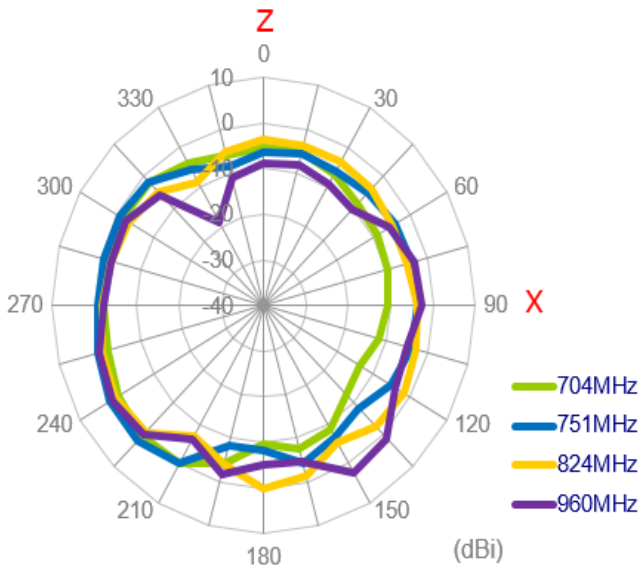

YZ Plane

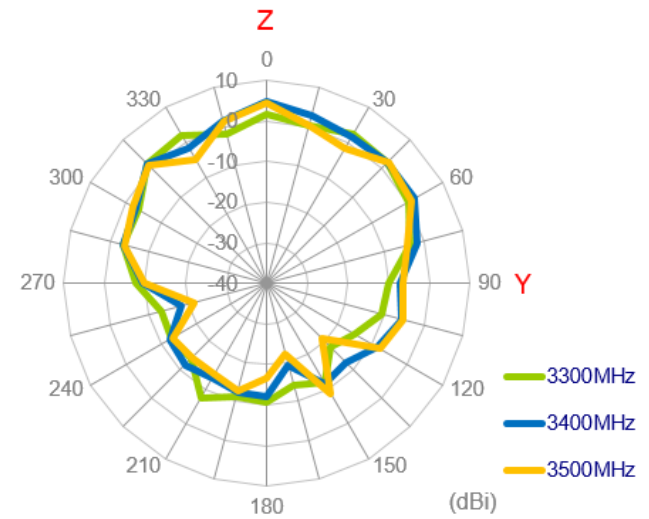
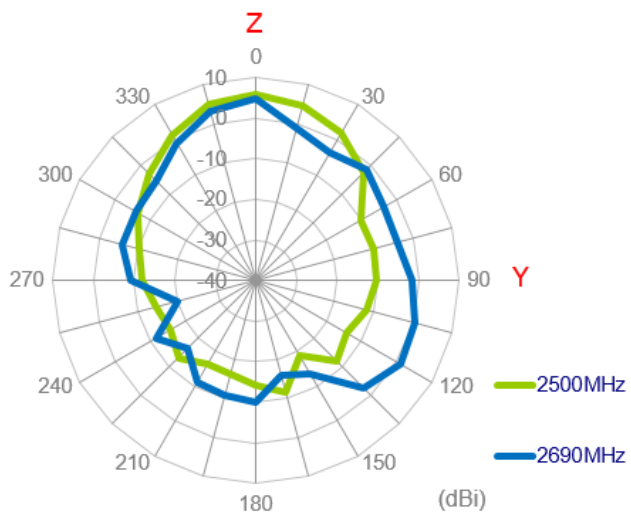
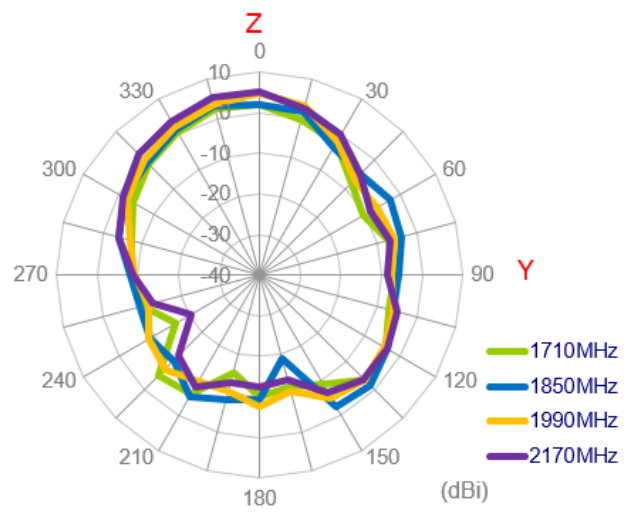
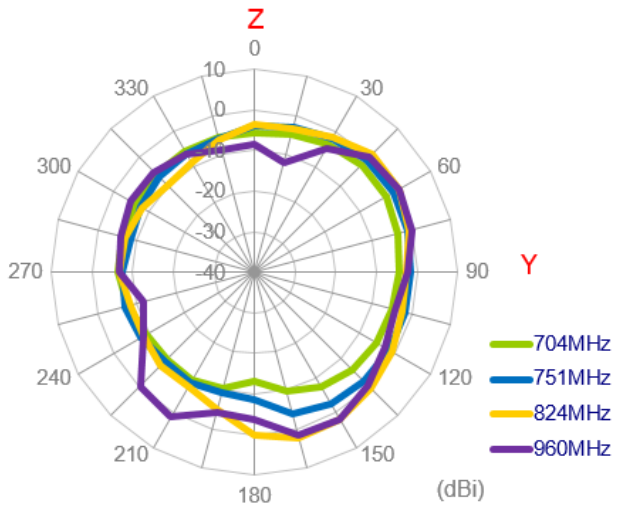

3.2.49 3D Radiation Patterns (LTE_MIMO2 with 1M cable length on metal)

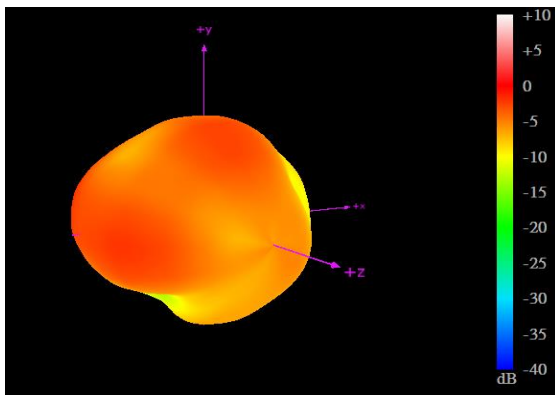

704MHz

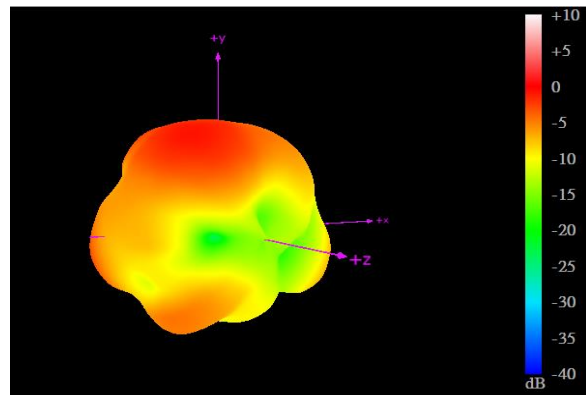

960MHz

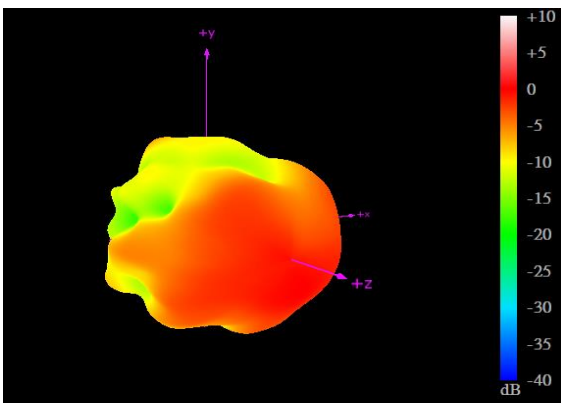

1710MHz

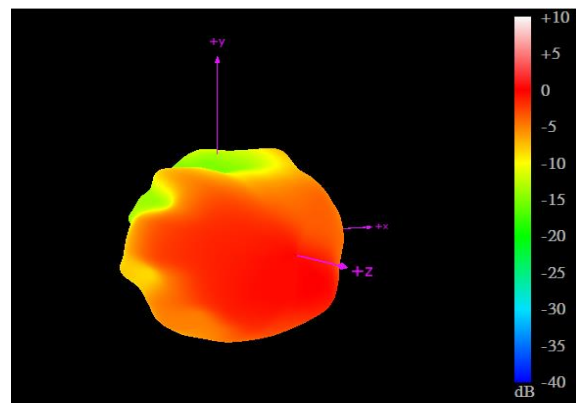

2170MHz

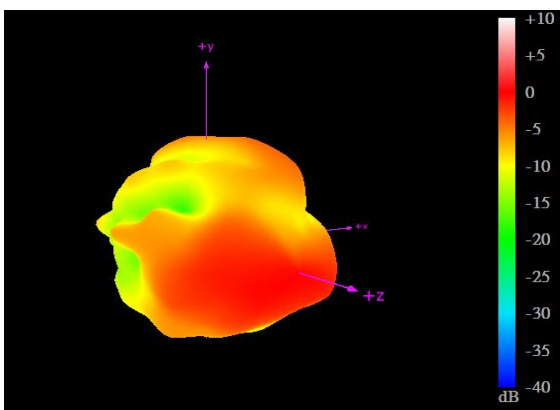

2690MHz

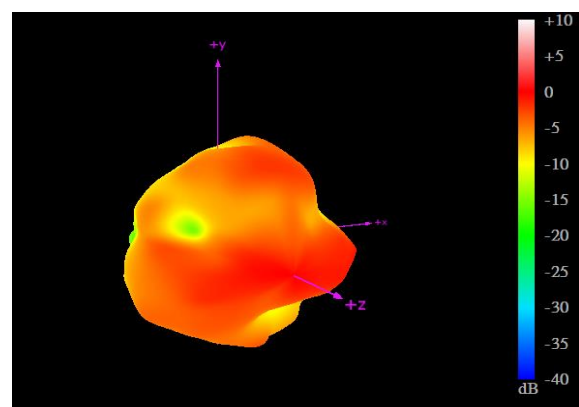

3500MHz

3.2.50 2D Radiation Patterns (LTE_MIMO2 with 1M cable length on metal)

XY Plane

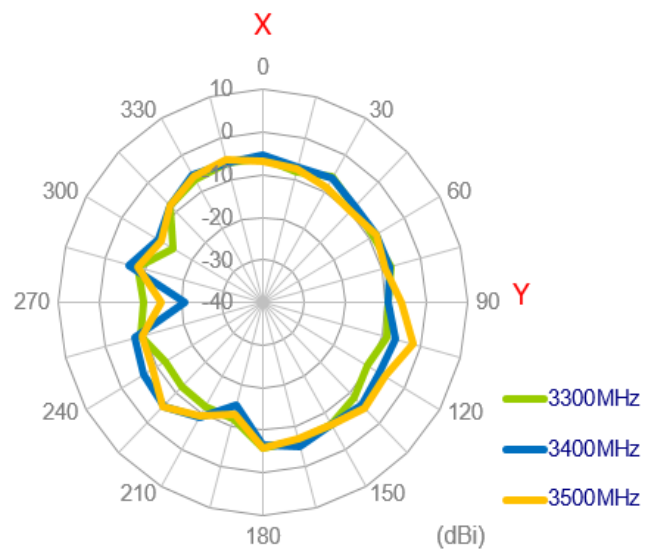
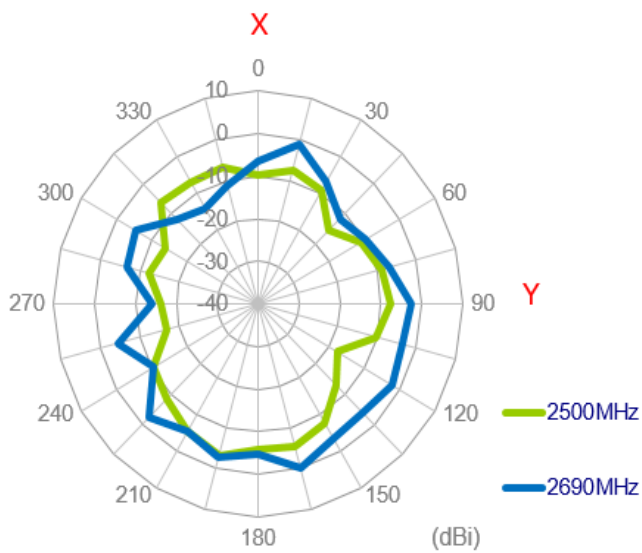
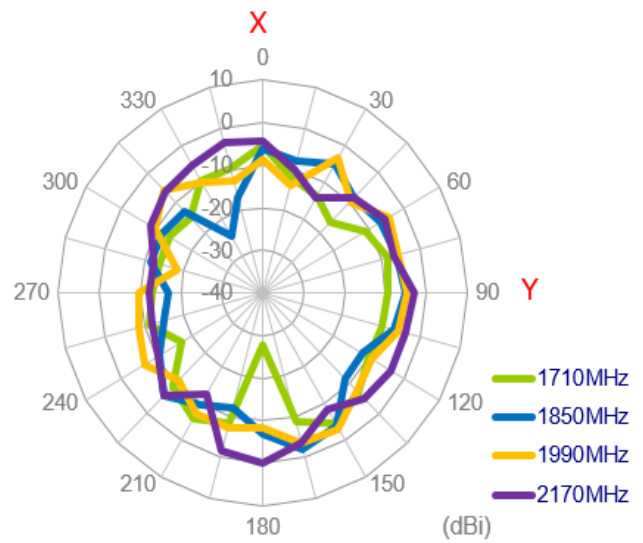
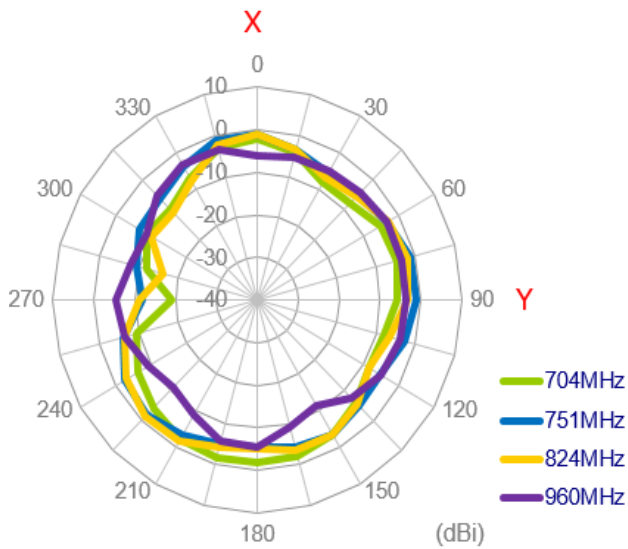

XZ Plane

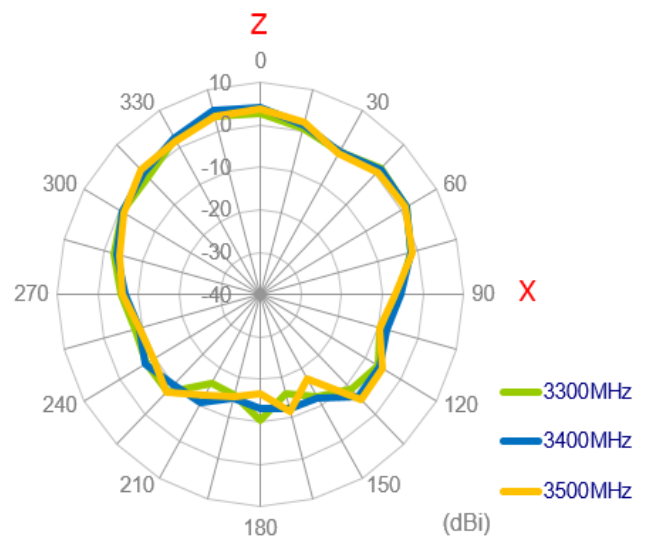
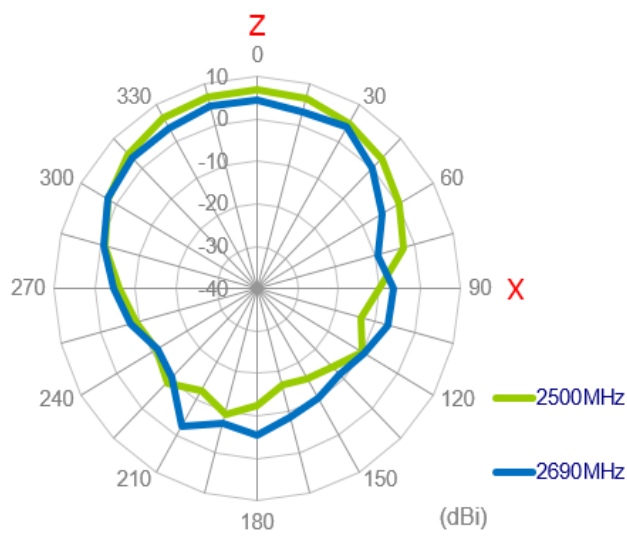
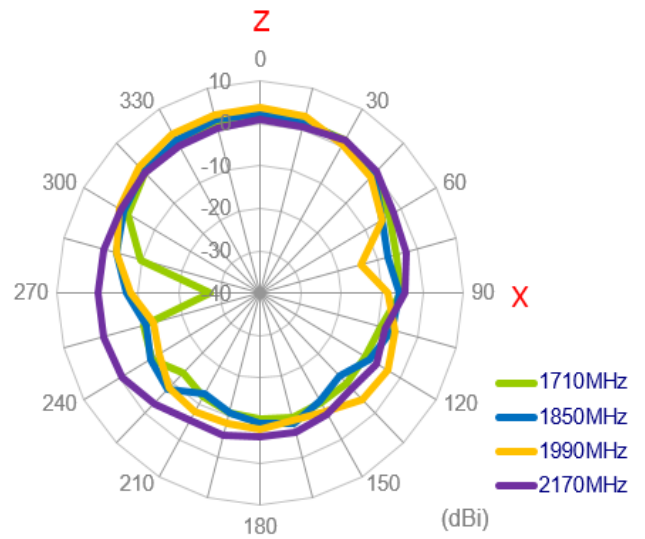
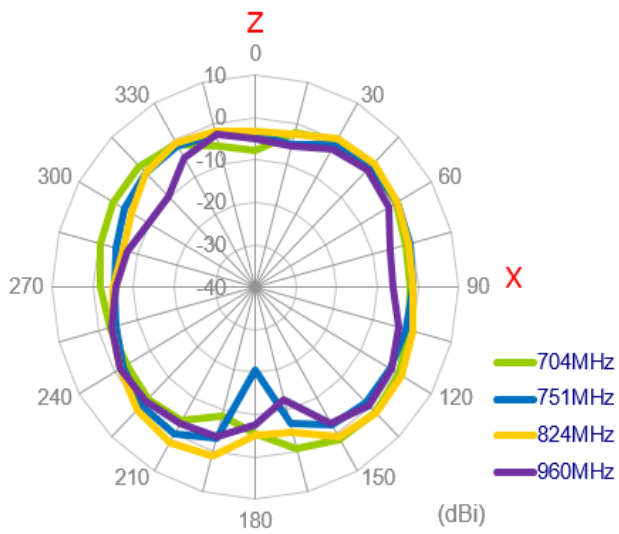

YZ Plane

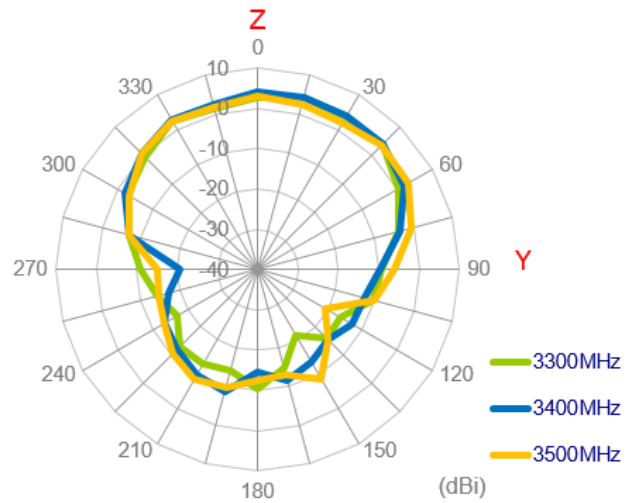
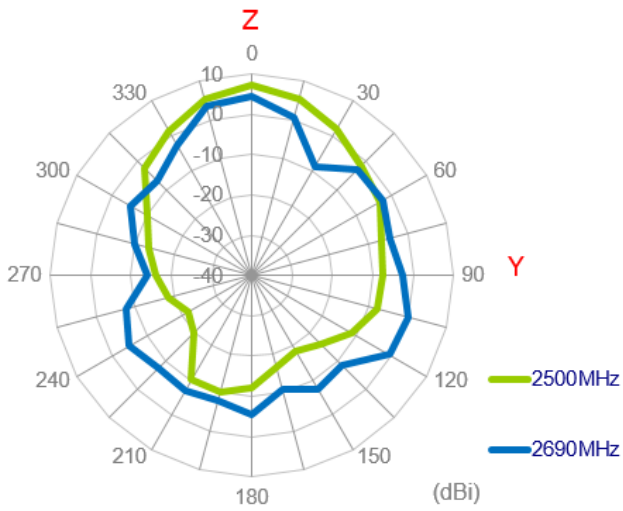
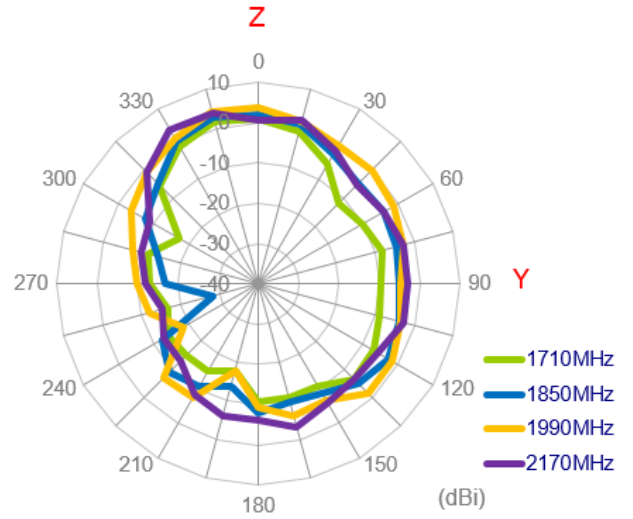
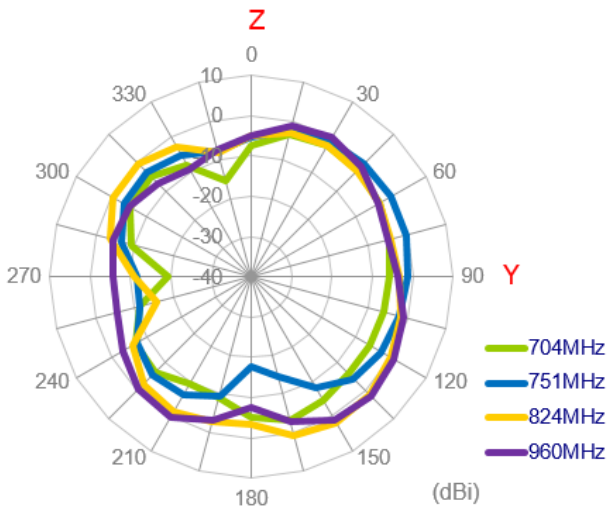

3.2.51 3D Radiation Patterns (LTE_MIMO2 with 1M cable length on metal)

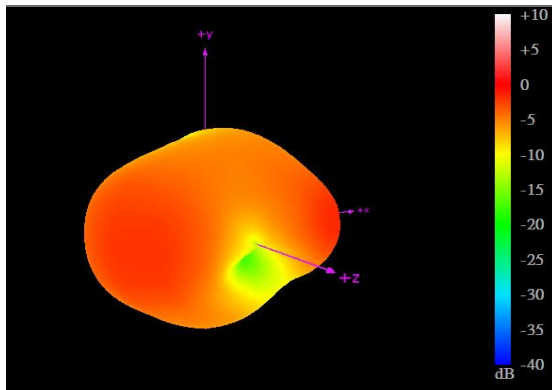

704MHz

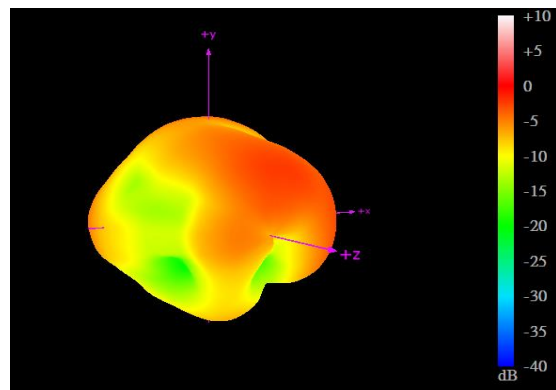

960MHz

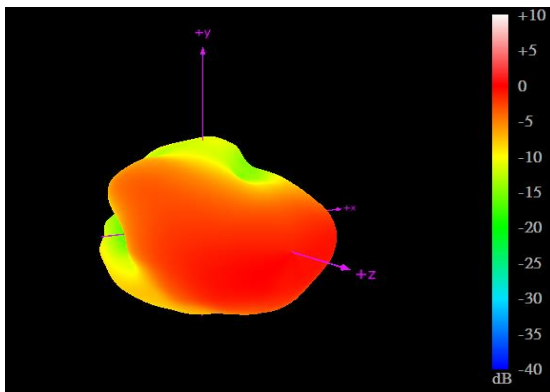

1710MHz

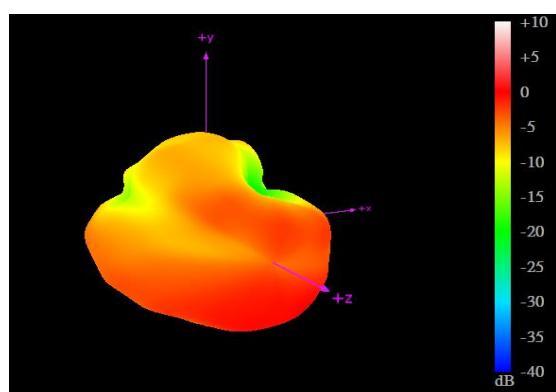

2170MHz

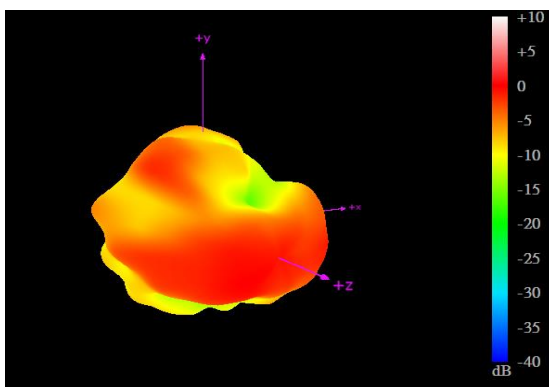

2690MHz

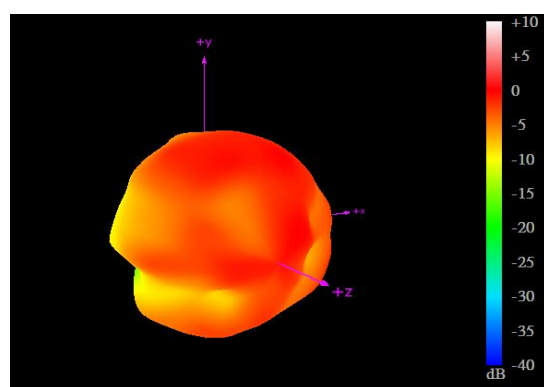

3500MHz

3.2.52 2D Radiation Patterns (LTE_MIMO2 with 1M cable length on metal)

XY Plane

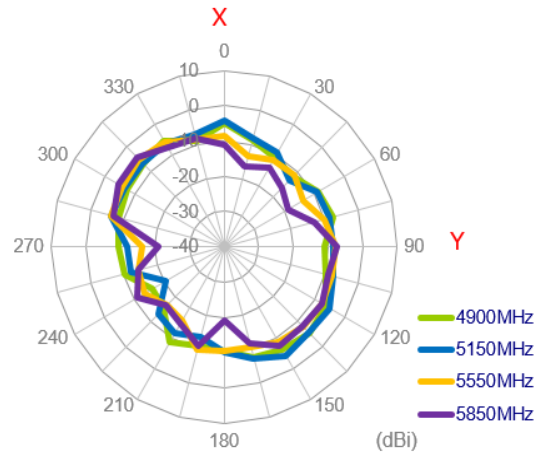
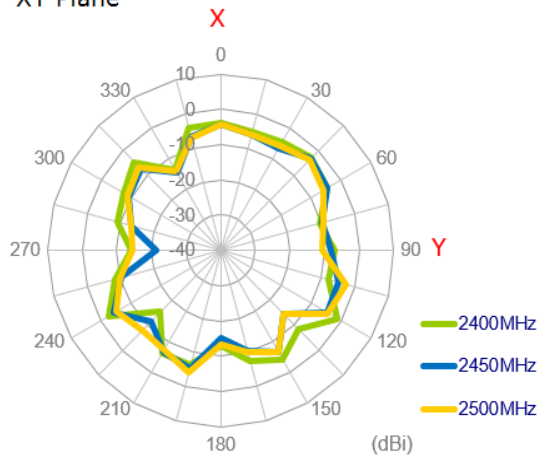

XZ Plane

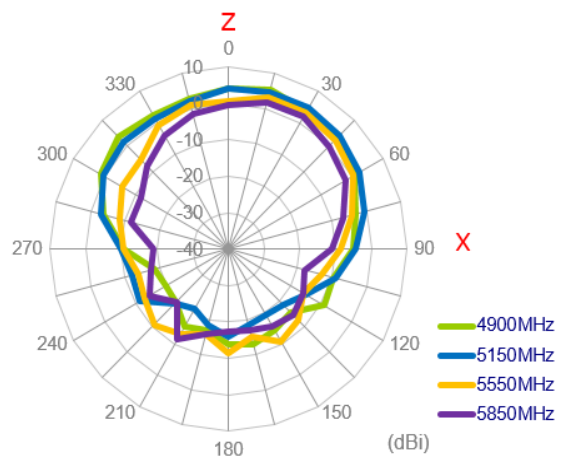
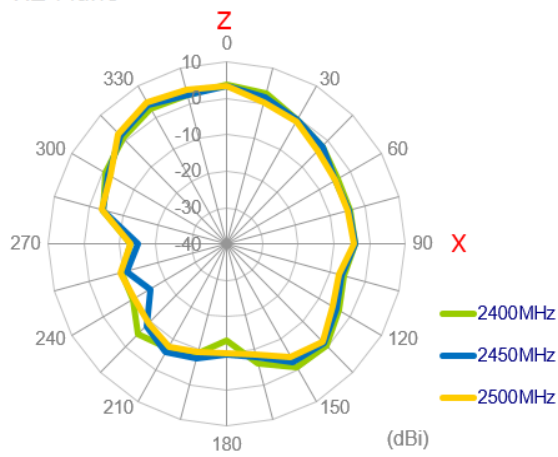

YZ Plane

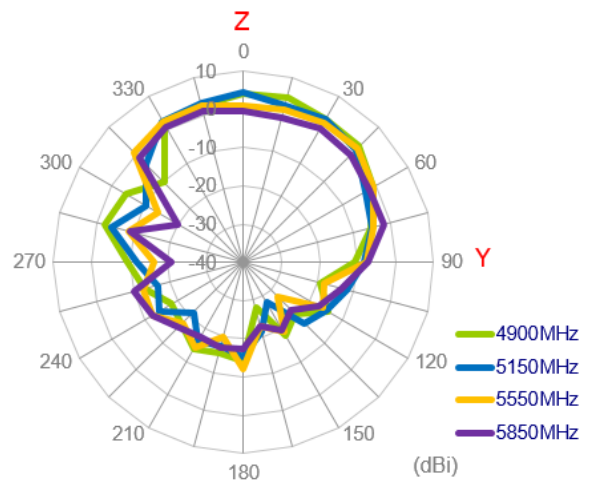
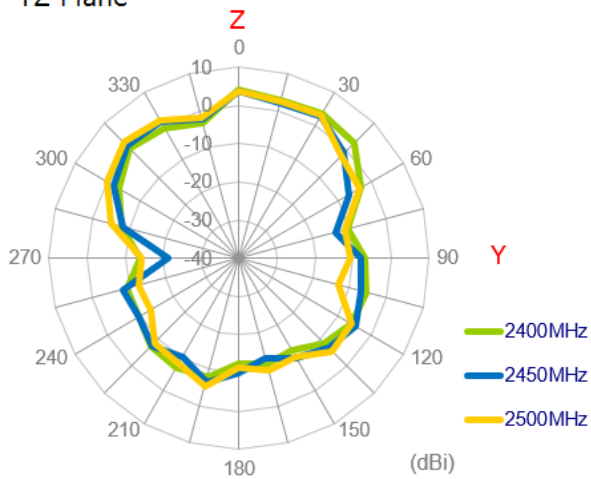

3.2.53 3D Radiation Patterns Pattern (Wi-Fi_MIMO2 with 1M cable length on glass)

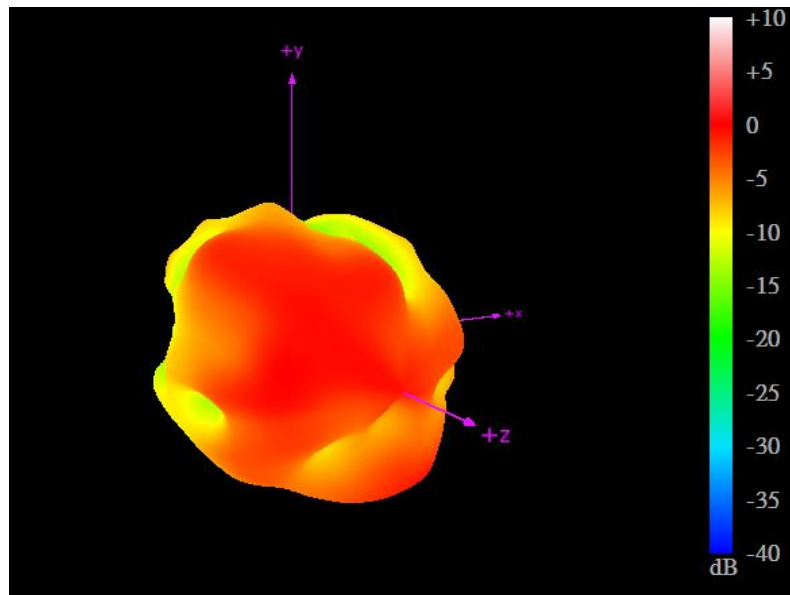

2450MHz

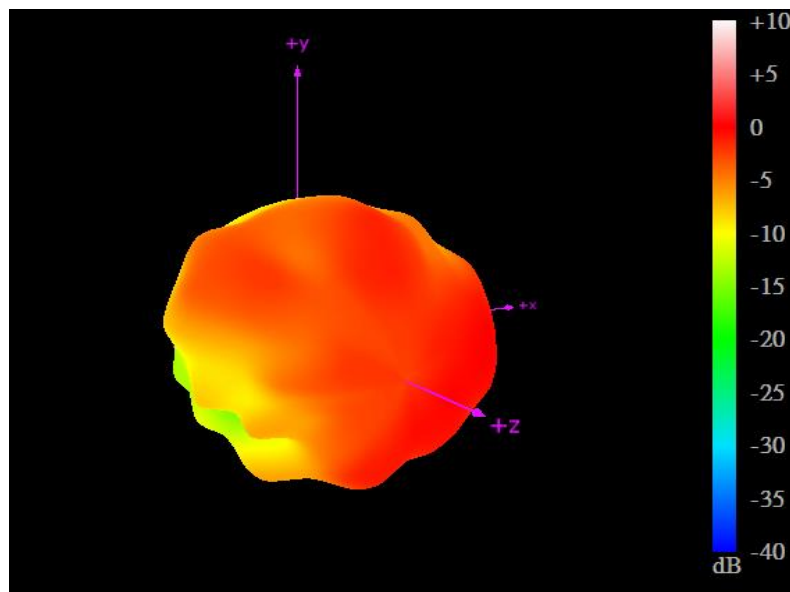

5550MHz

3.2.54 2D Radiation Patterns (LTE_MIMO1 with 1M cable length on metal)

XY Plane

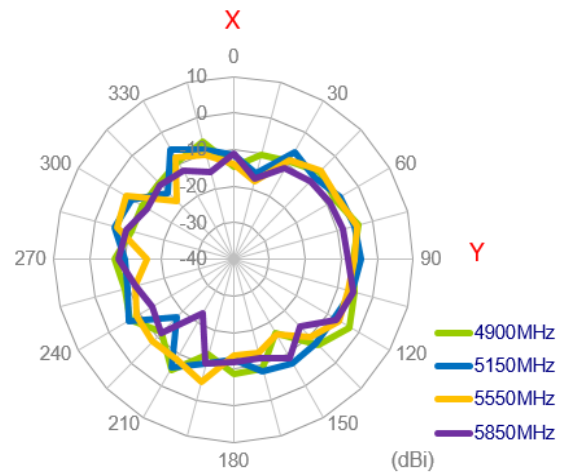
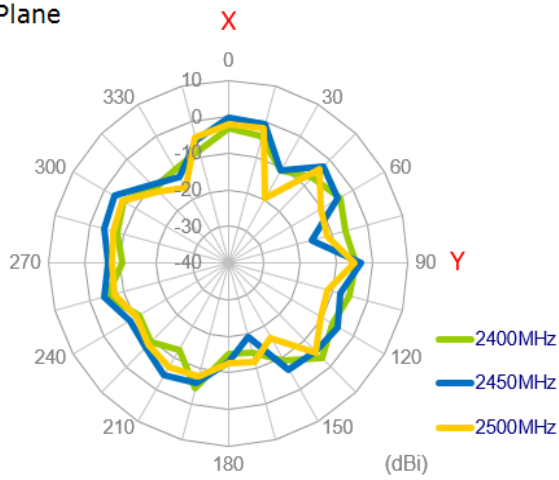

XZ Plane

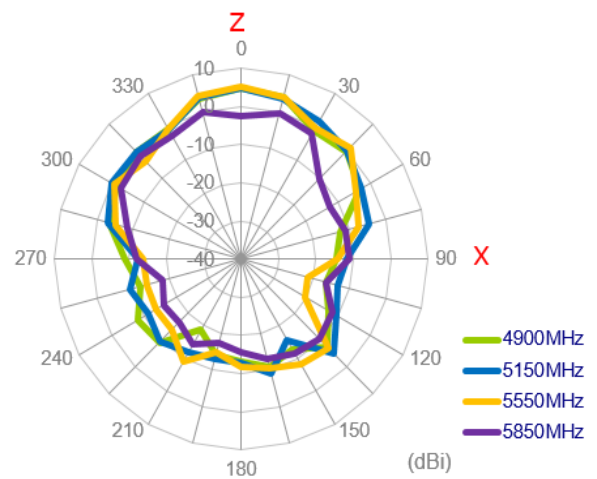
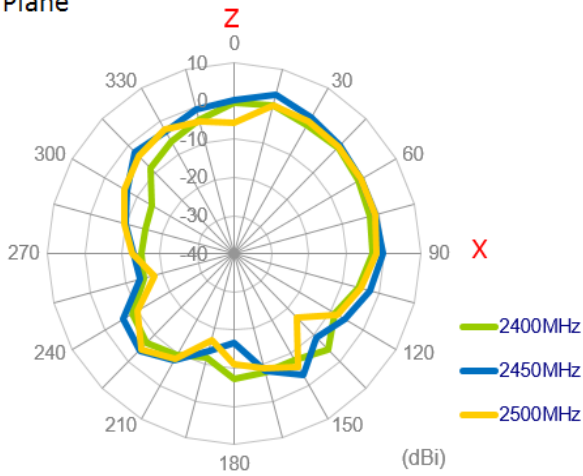

XZ Plane

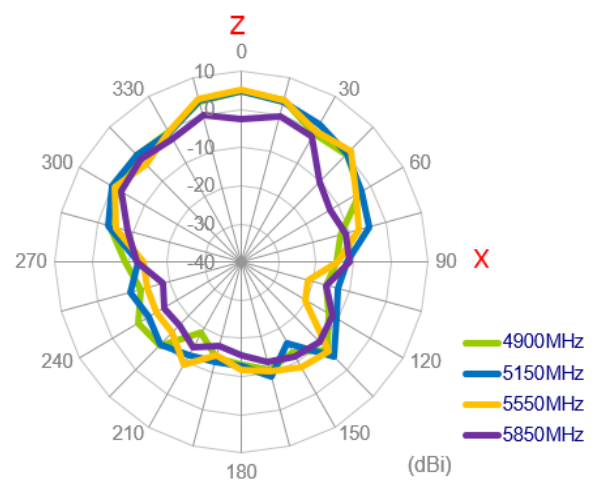
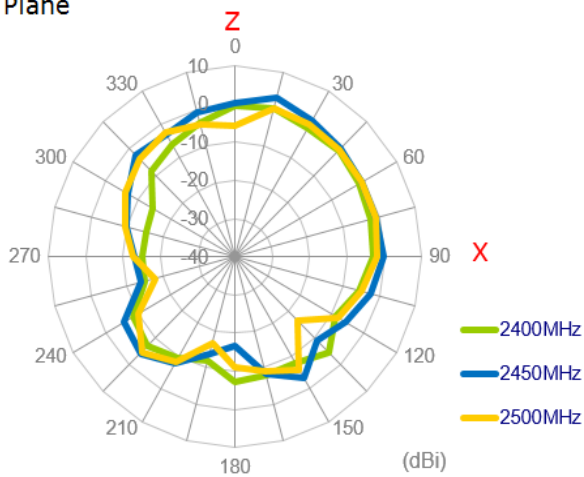

3.2.55 3D Radiation Patterns Pattern (Wi-Fi_MIMO2 with 1M cable length on metal)

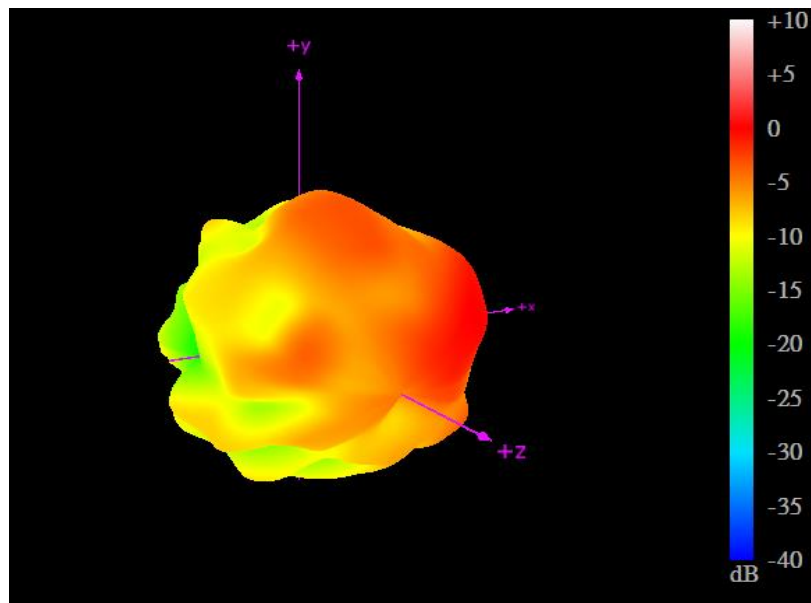

2450MHz

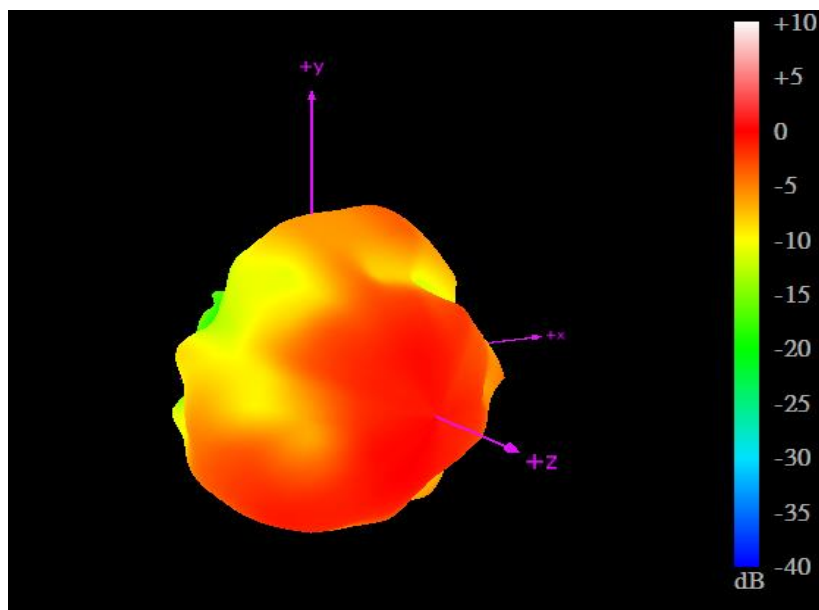

5550MHz

3.2.56 Test Setup for Antenna Radiation Pattern

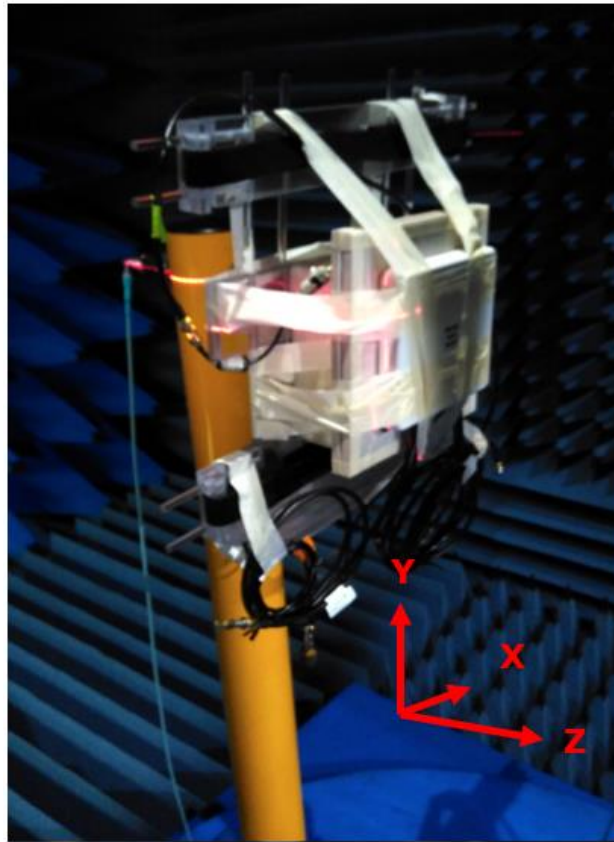

On the wall

3.2.57 2D Radiation Patterns (LTE_MIMO1 with 1M cable length on the wall)

XY Plane

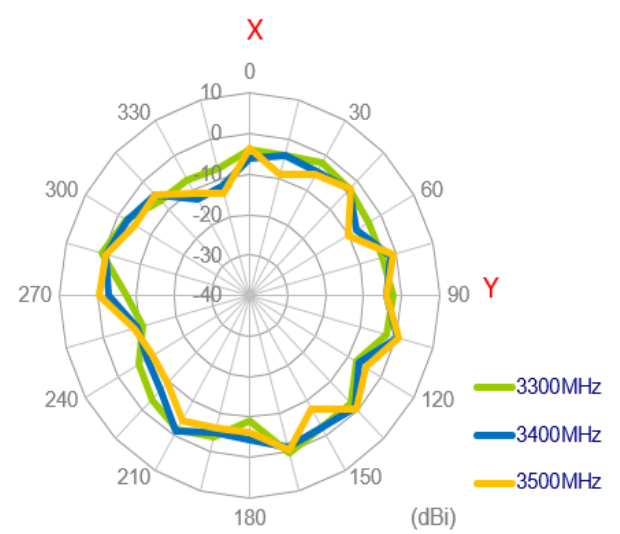
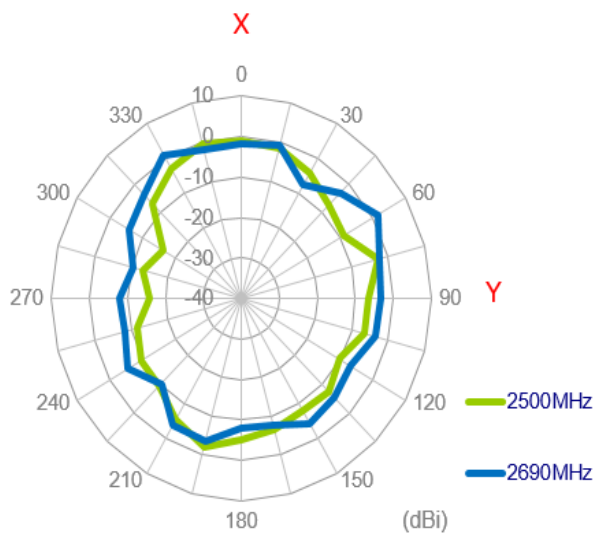
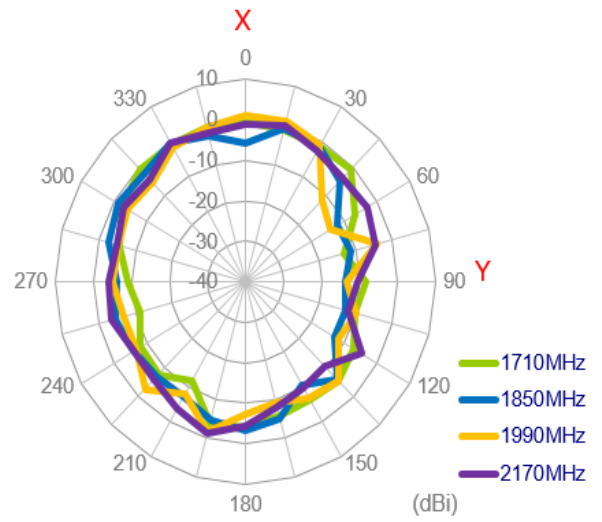
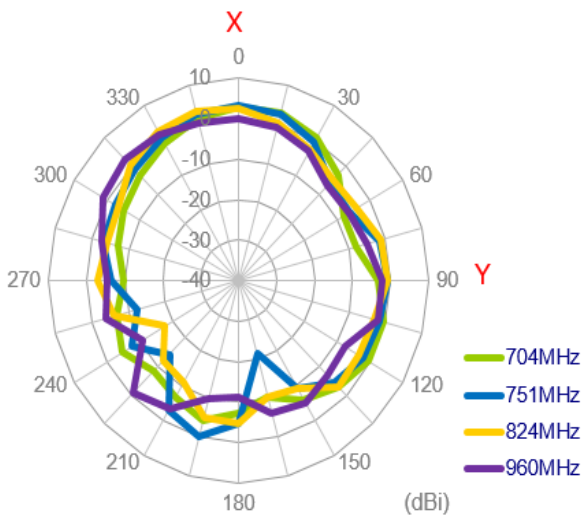

XZ Plane

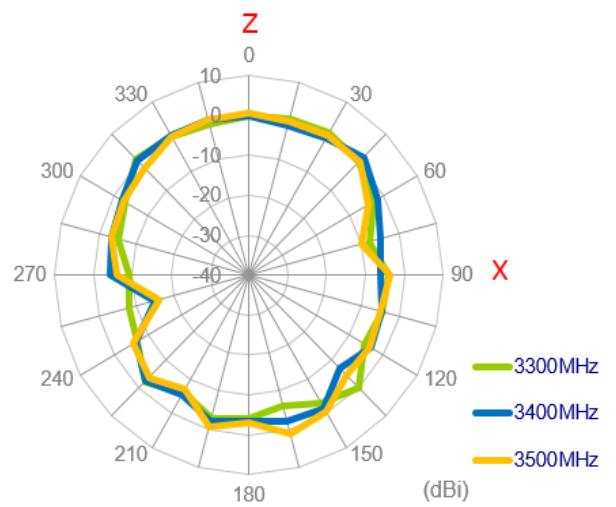
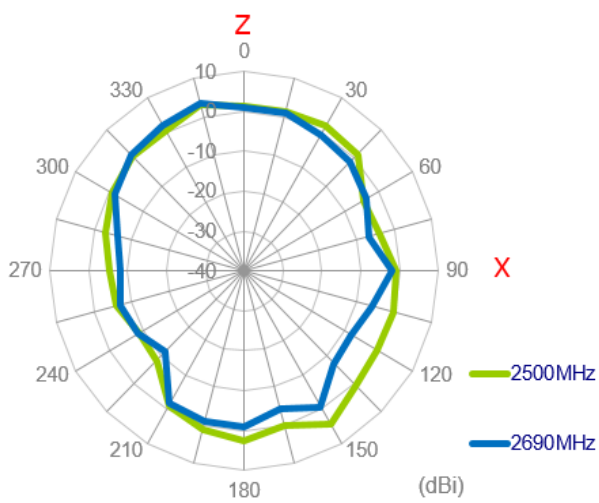
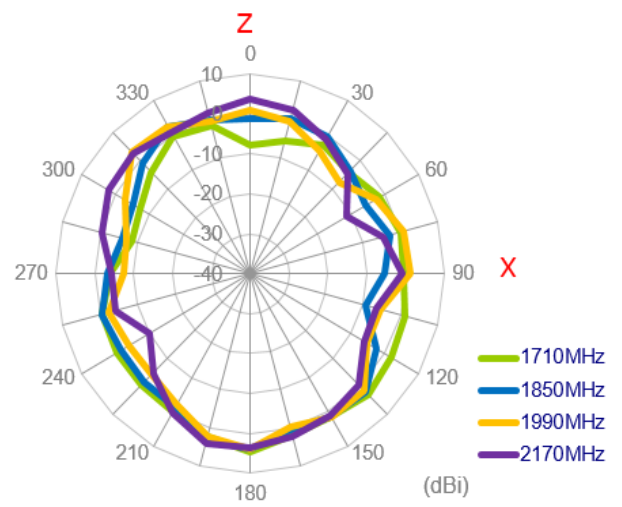
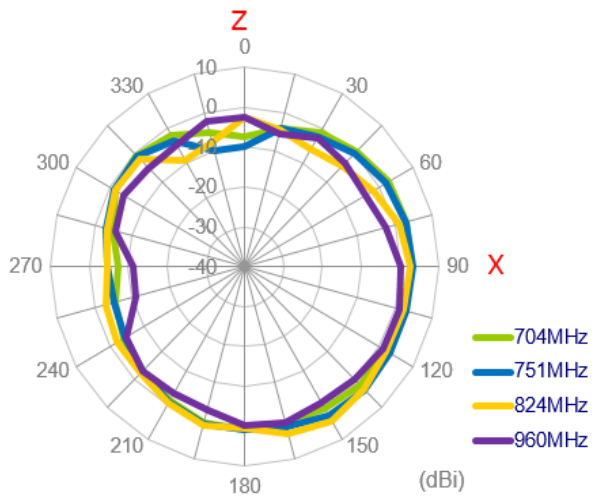

YZ Plane

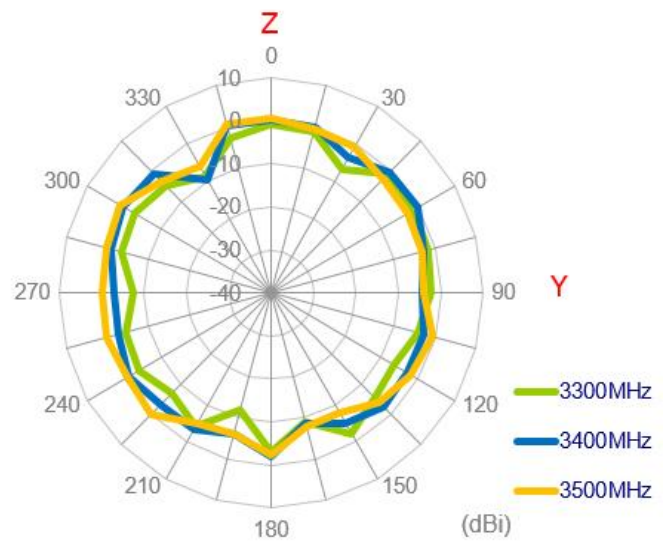
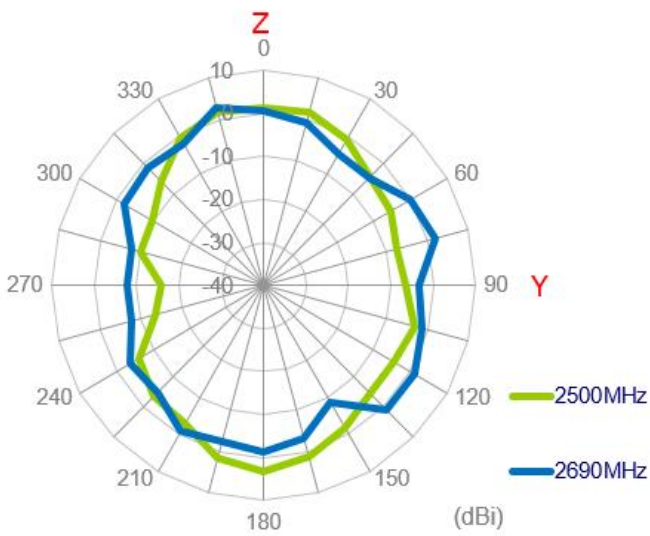
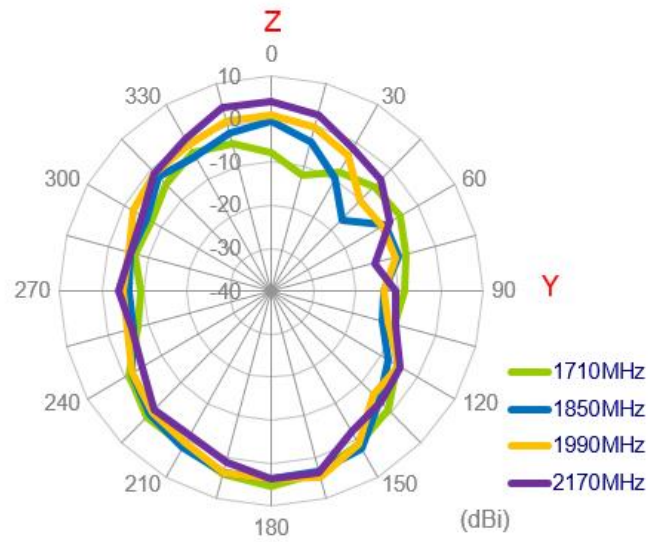
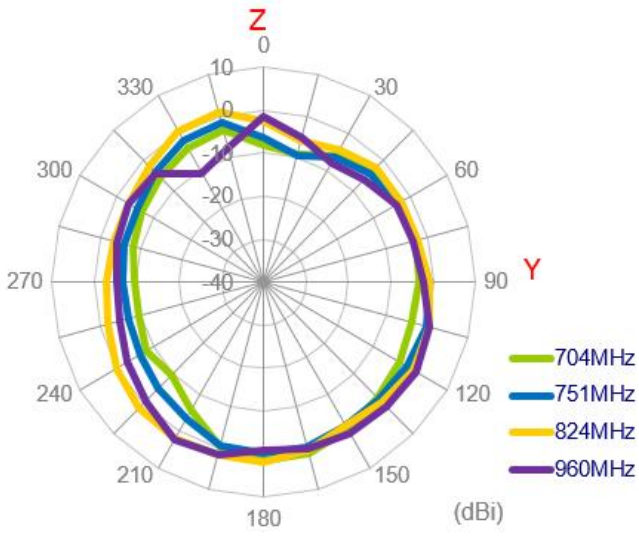

3.2.58 3D Radiation Patterns (LTE_MIMO1 with 1M cable length on the wall)

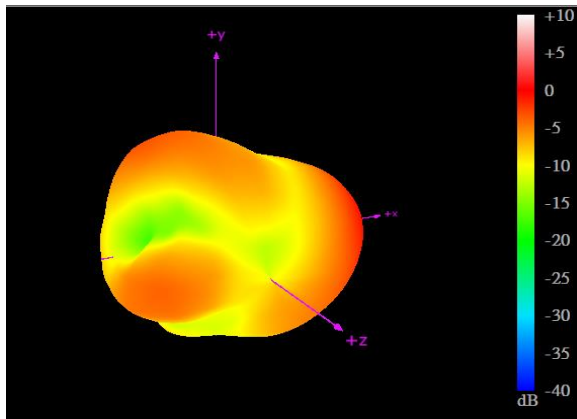

704MHz

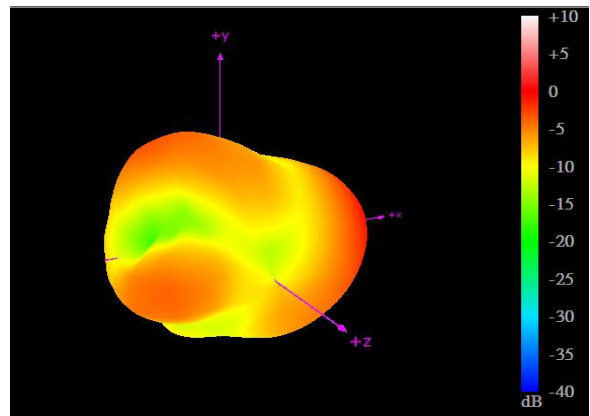

960MHz

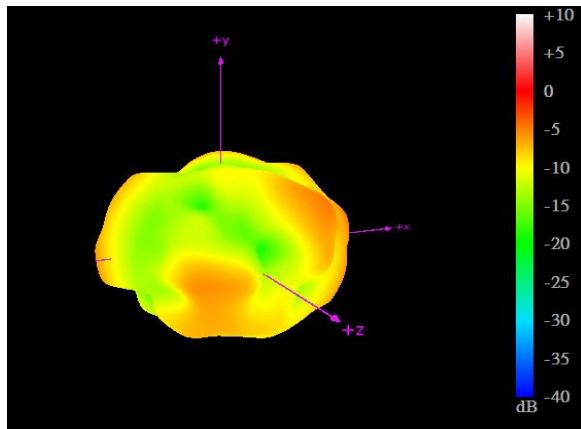

1710MHz

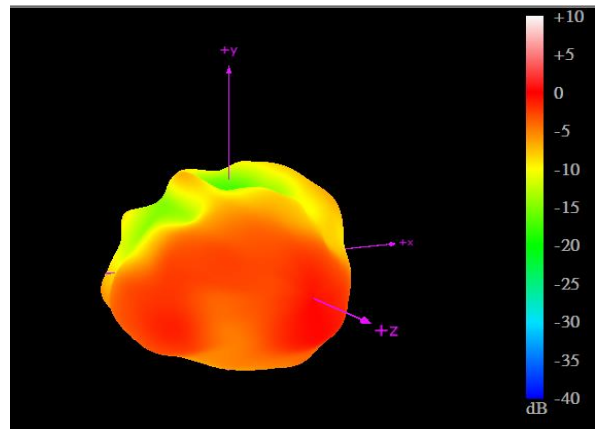

2170MHz

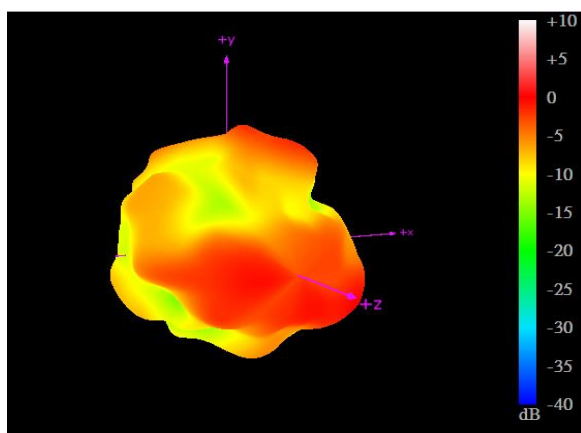

2690MHz

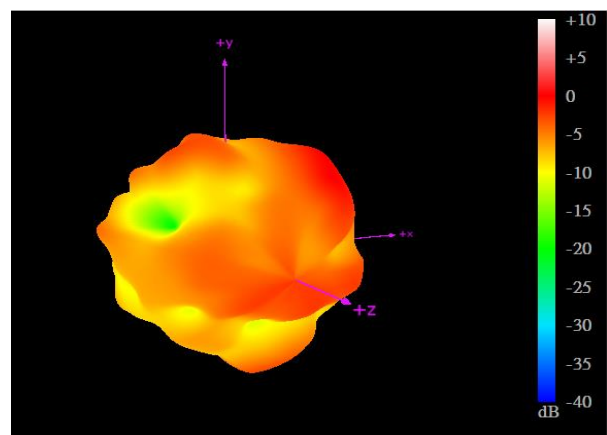

3500MHz

3.2.59 2D Radiation Patterns (LTE_MIMO1 with 1M cable length on the wall)

XY Plane

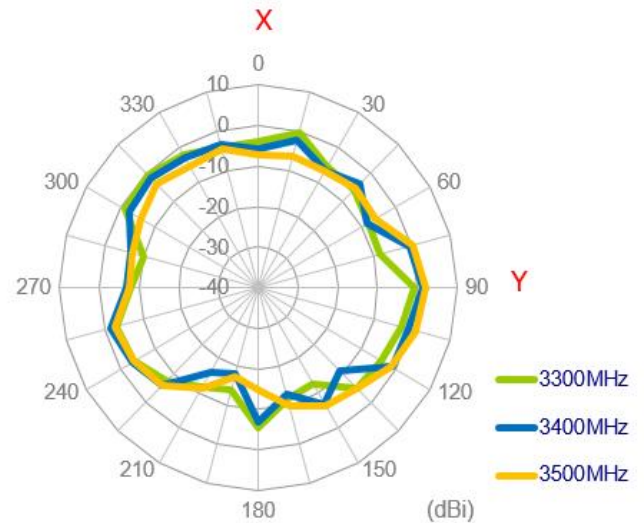
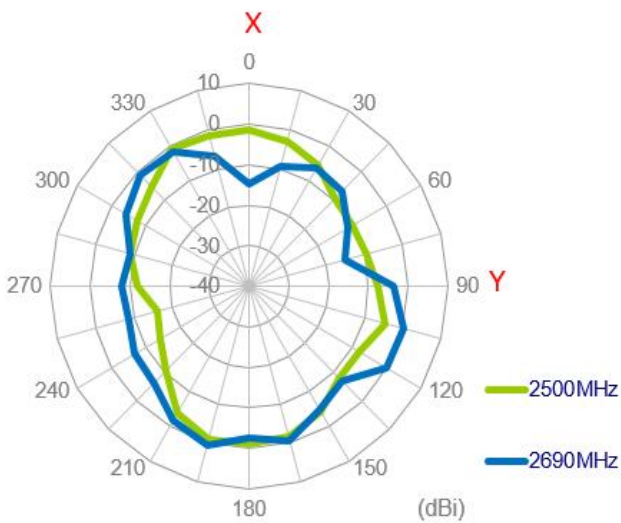
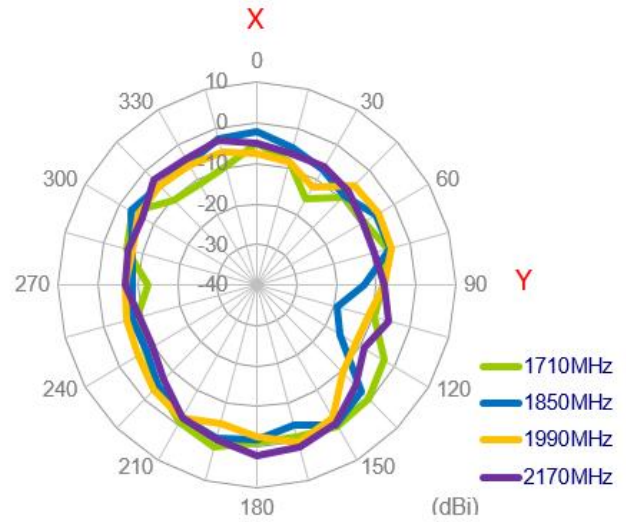
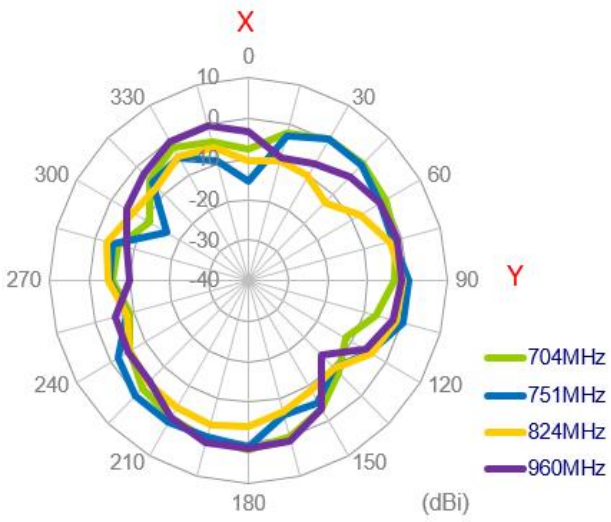

XZ Plane

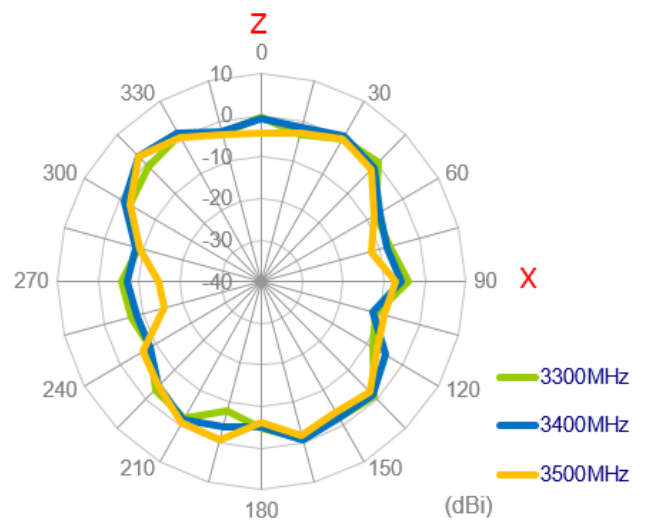
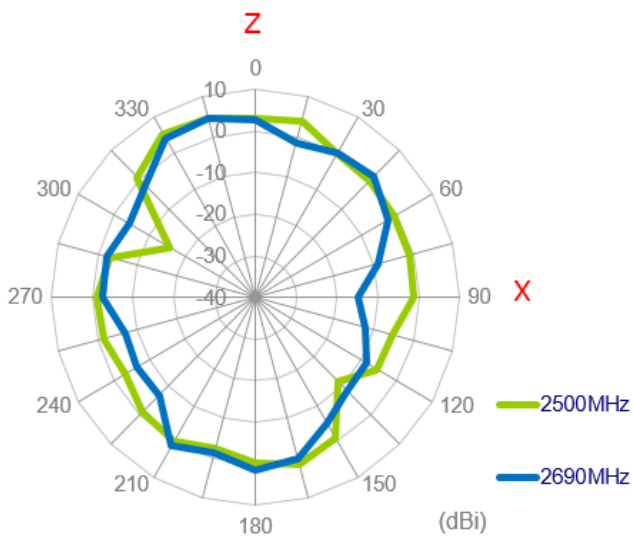
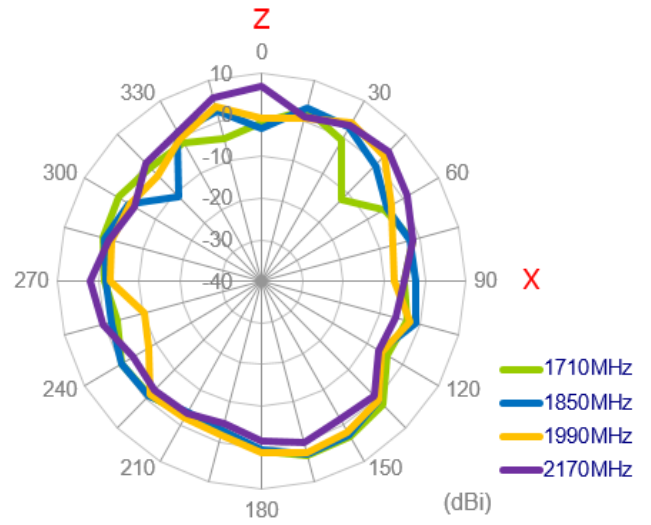
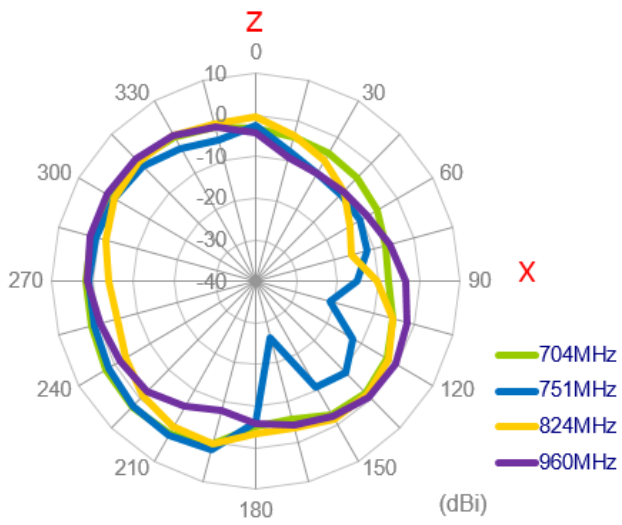

YZ Plane

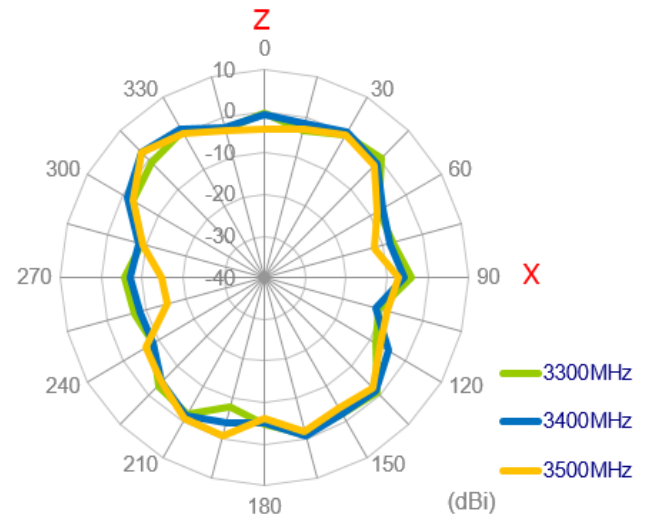
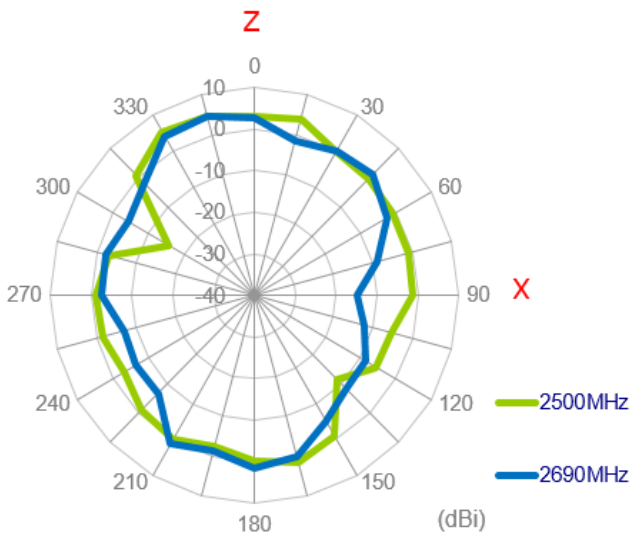
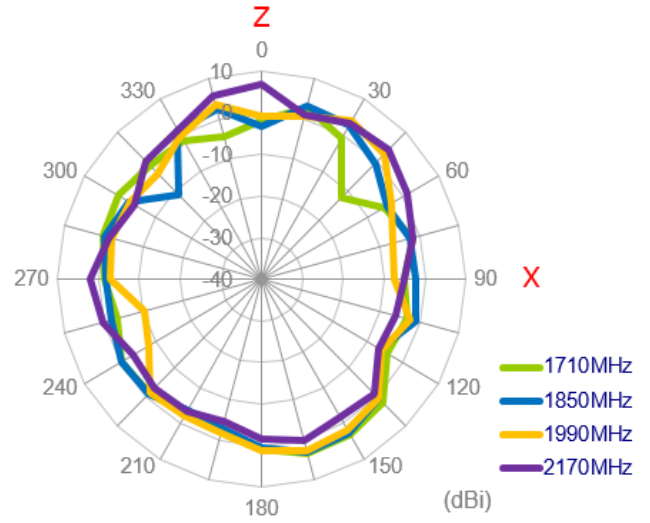
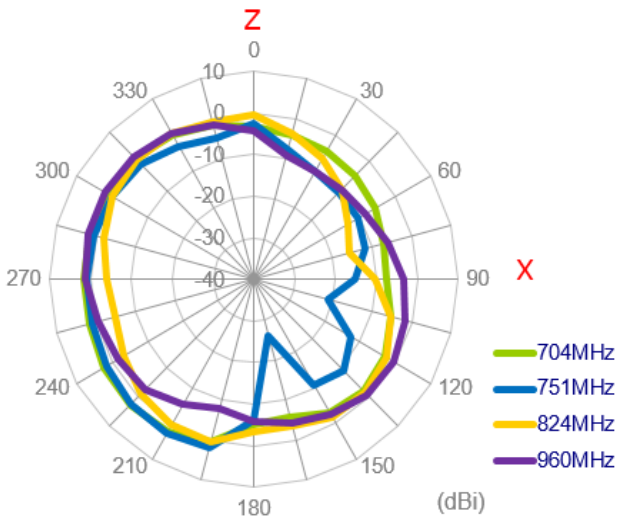

3.2.60 3D Radiation Patterns (LTE_MIMO1 with 1M cable length on the wall)

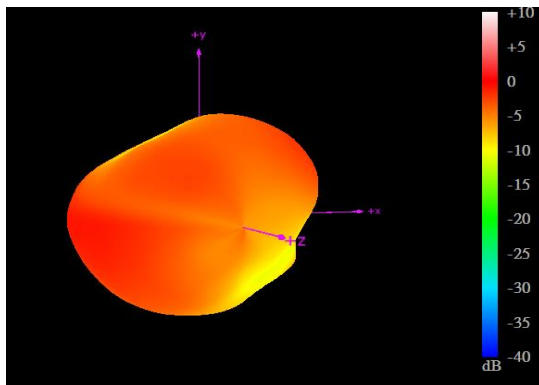

704MHz

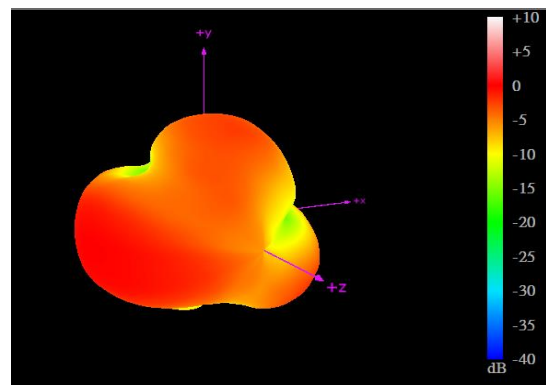

960MHz

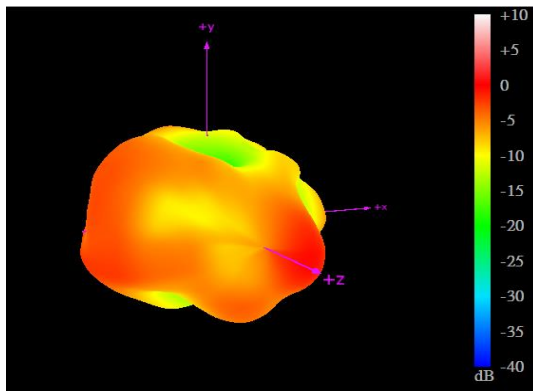

1710MHz

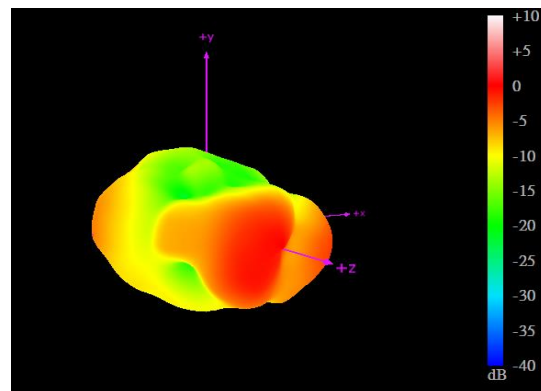

2170MHz

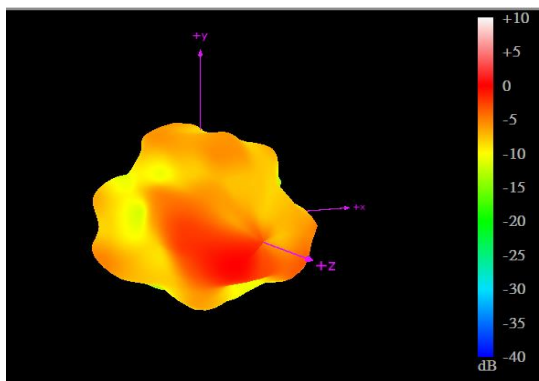

2690MHz

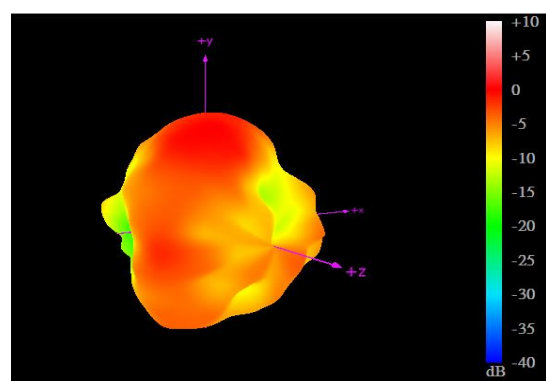

3500MHz

3.2.61 2D Radiation Patterns (Wi-Fi_MIMO1 with 1M cable length in free space)

XY Plane

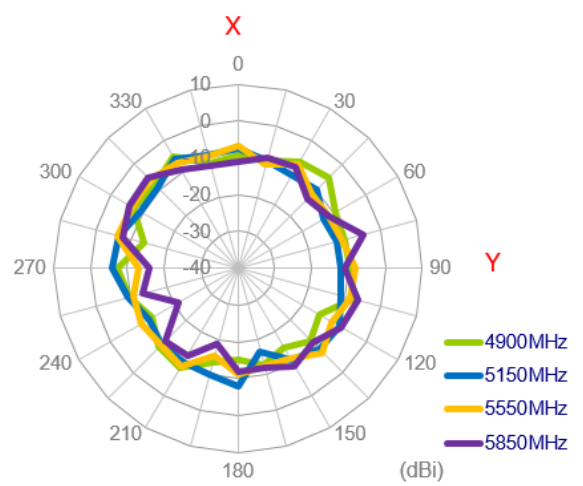
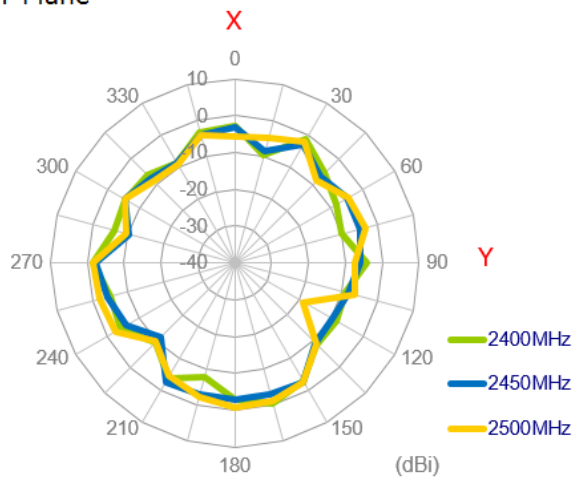

XZ Plane

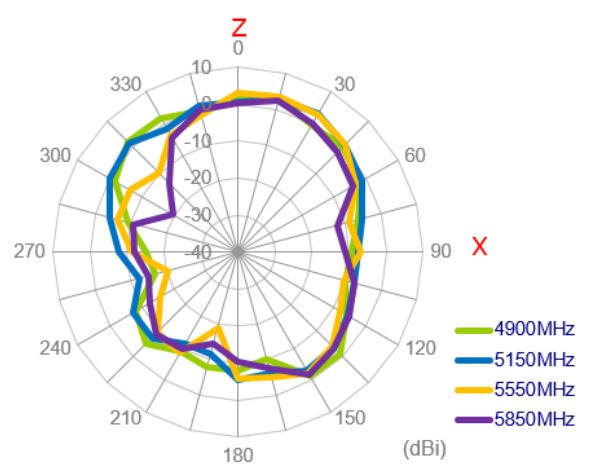
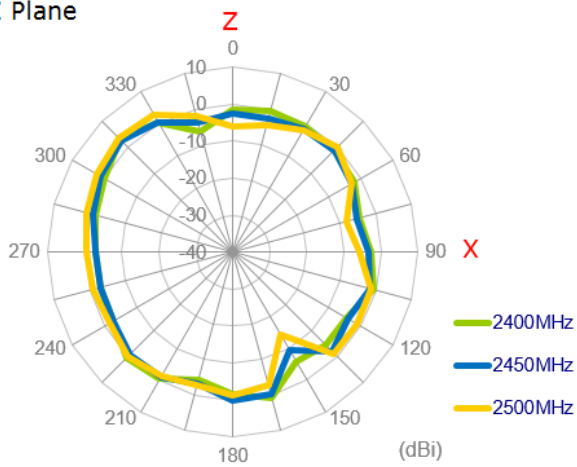

XY Plane

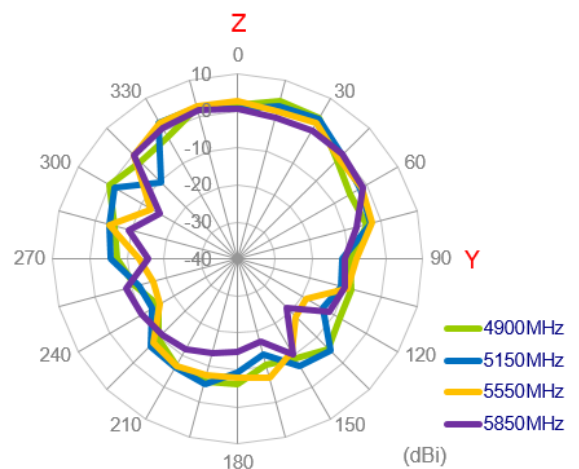
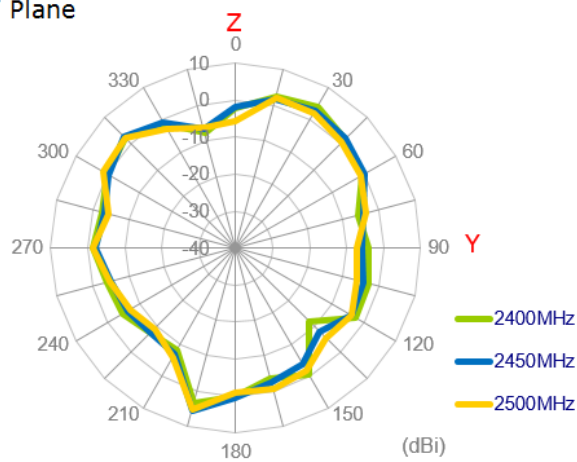

3.2.62 3D Radiation Patterns Pattern (Wi-Fi_MIMO2 with 1M cable length in free space)

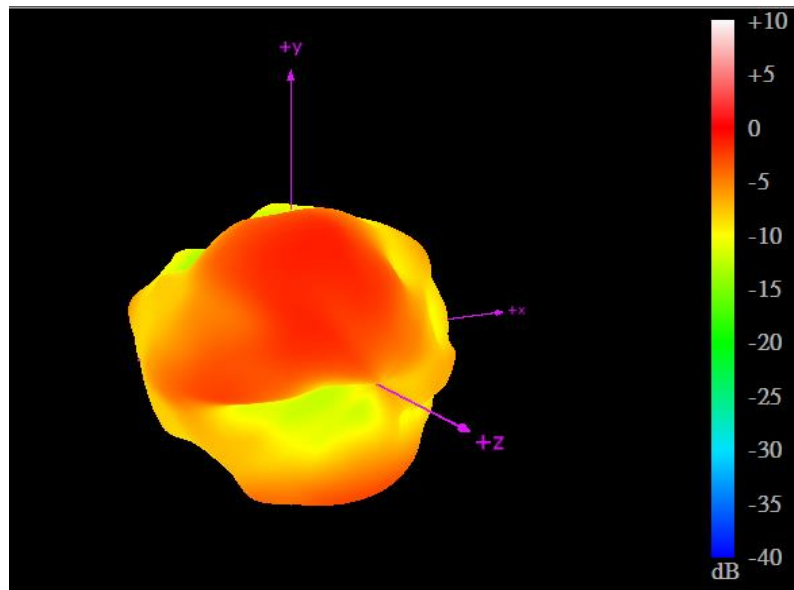

2450MHz

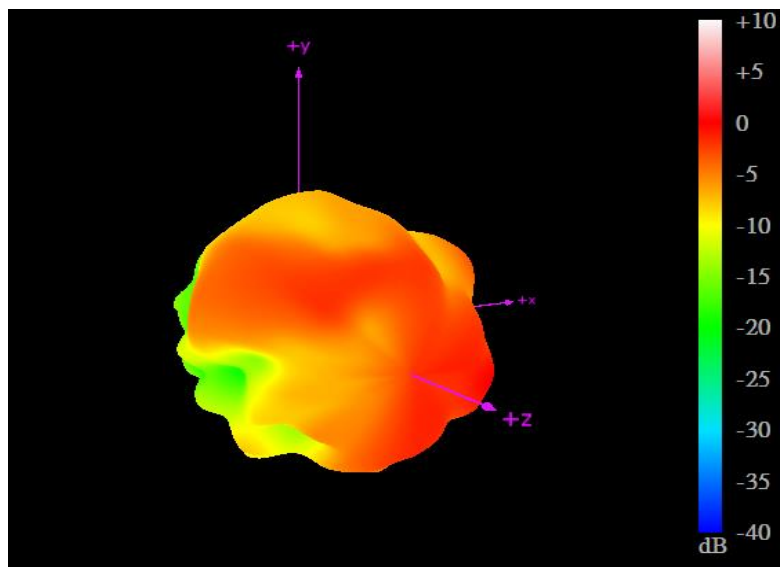

5550MHz

3.2.63 2D Radiation Patterns (Wi-Fi_MIMO2 with 2M cable length in free space)

XY Plane

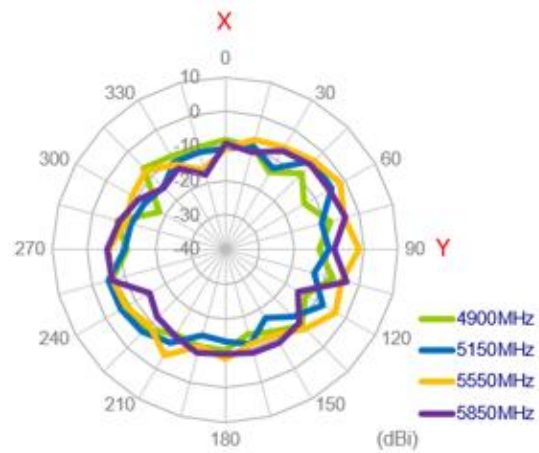
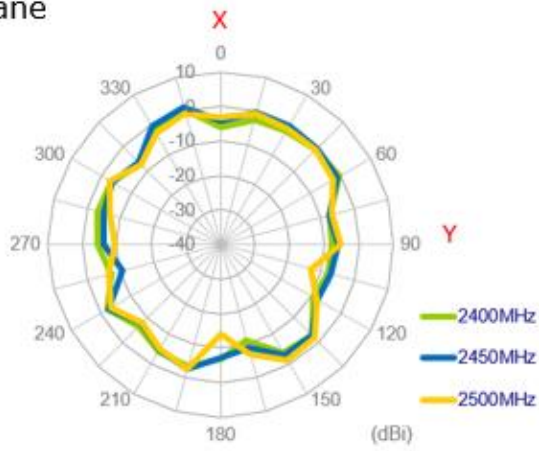

XZ Plane

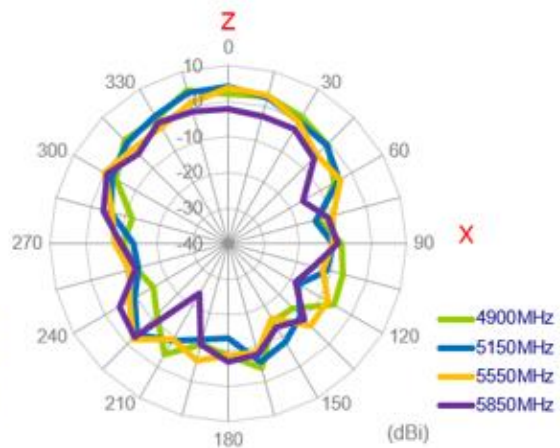
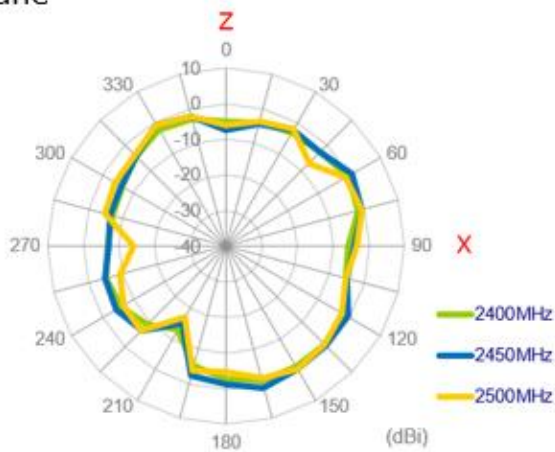

YZ Plane

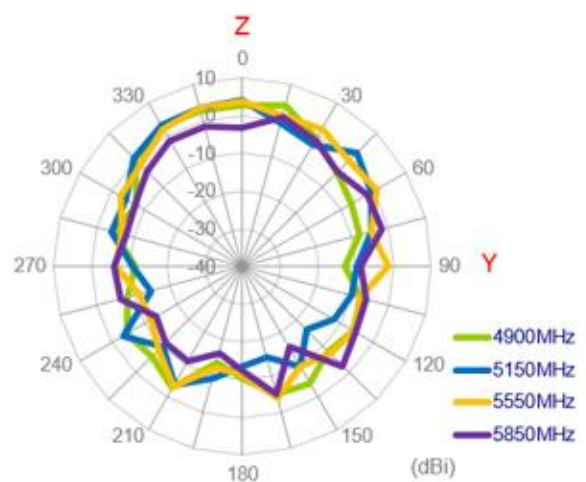
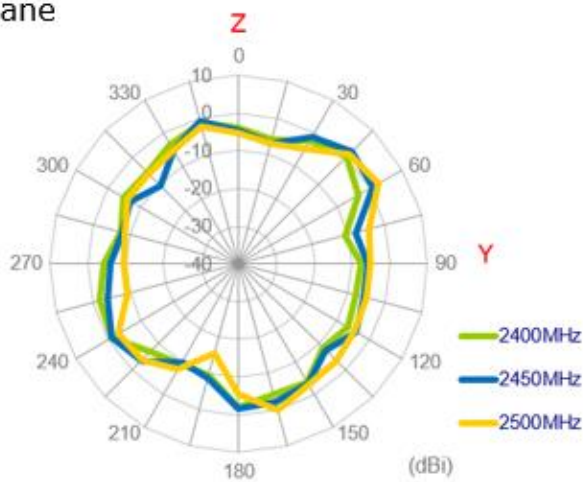

3.2.64 3D Radiation Patterns Pattern (Wi-Fi_MIMO2 with 1M cable length in free space)

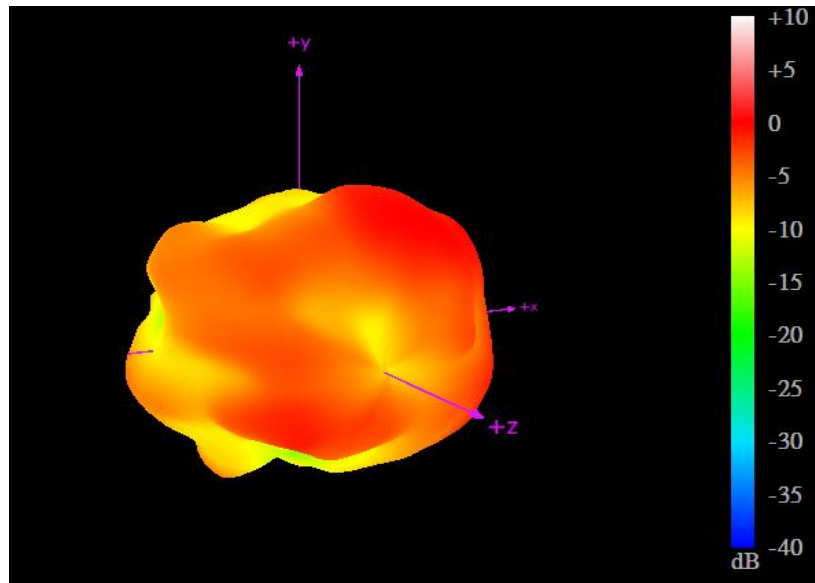

2450MHz

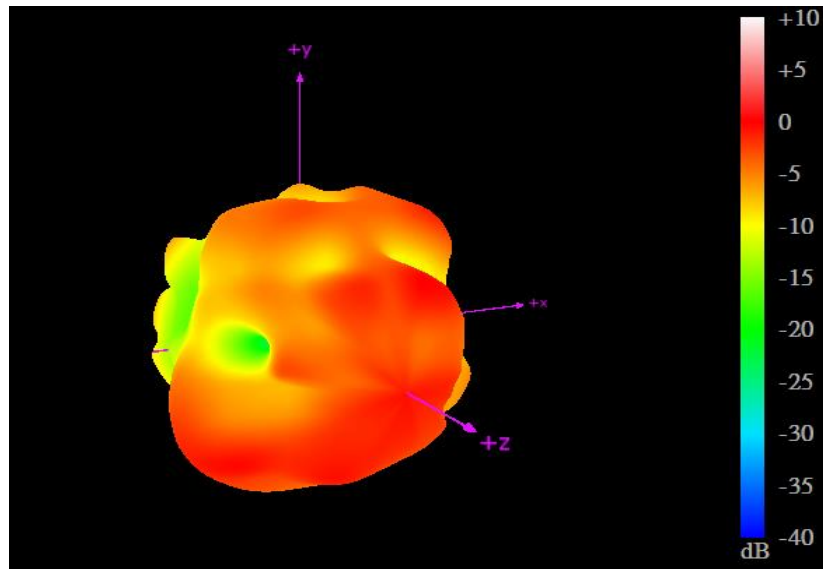

5550MHz

4. Mechanical Drawing (Units: mm)

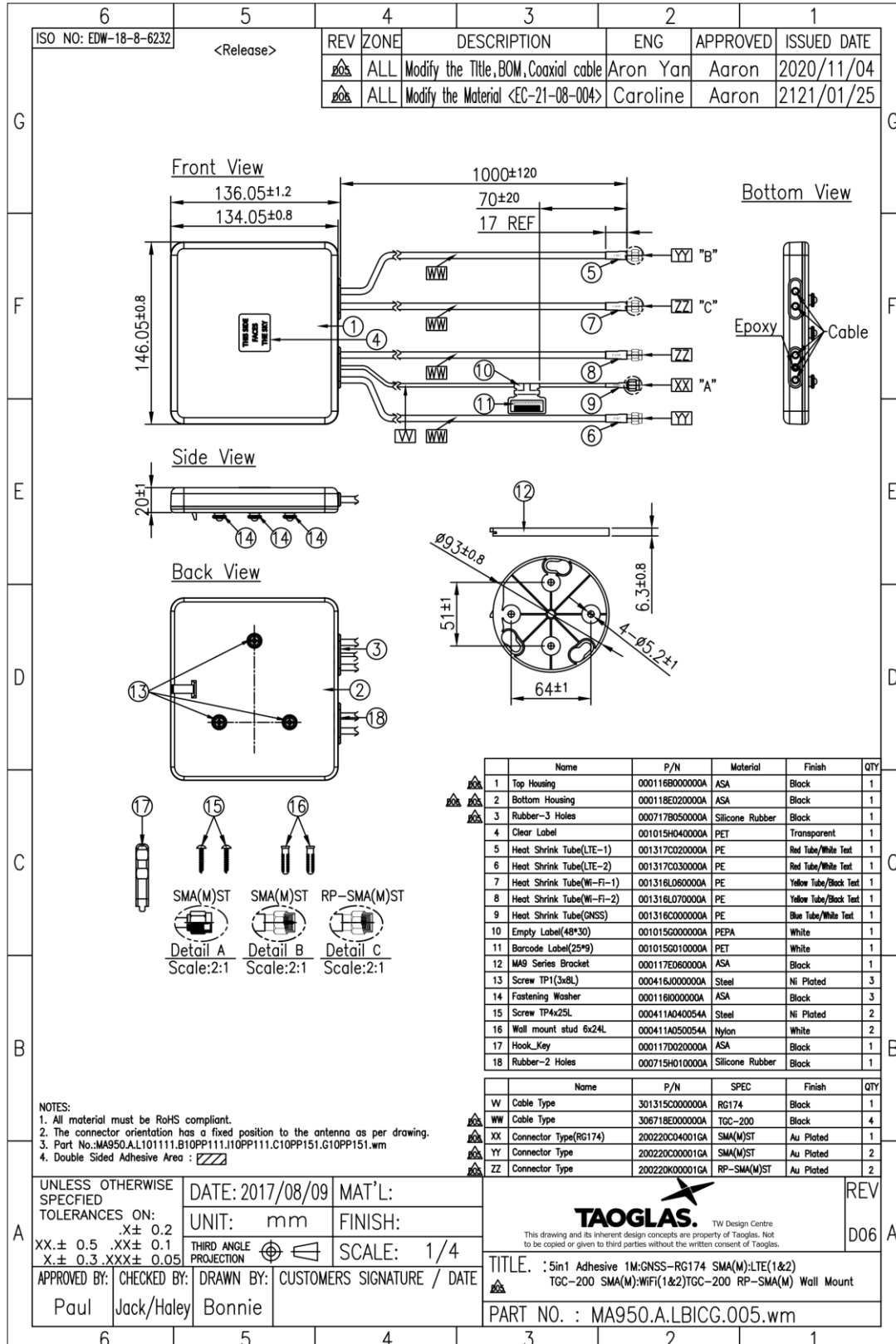

5. Packaging

1 MA950.A.LBICG.005.wm per small box
 Box Dimensions - 260 x 235 x 105mm
 Weight - 700g

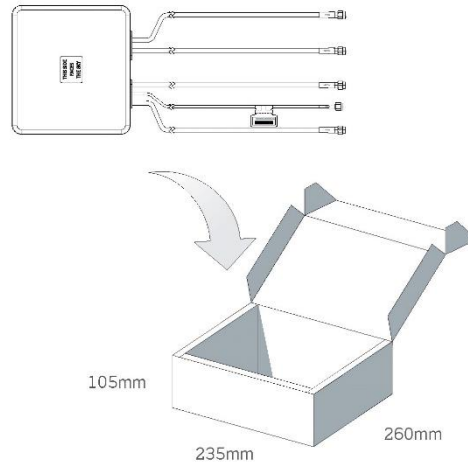

1 Outer Carton
 Carton Dimensions - 540 x 490 x 240mm
 8 pcs MA950.A.LBICG.005.wm per carton
 Weight - 6.63Kg

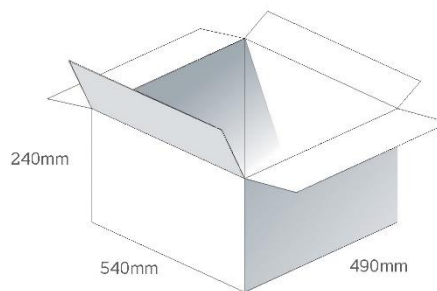

Pallet Dimensions 1200*1000*1400mm
 20 Cartons per Pallet
 4 Cartons per layer
 5 Layers

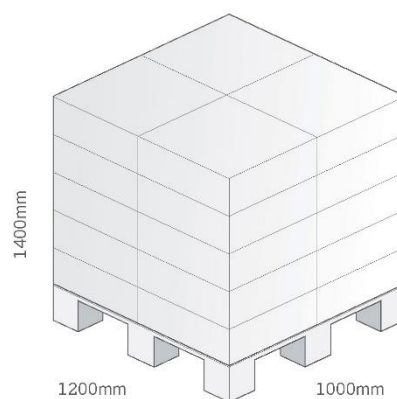

6. Application Note

6.1 In free space (LTE)

6.1.1 Return Loss (LTE MIMO 1)

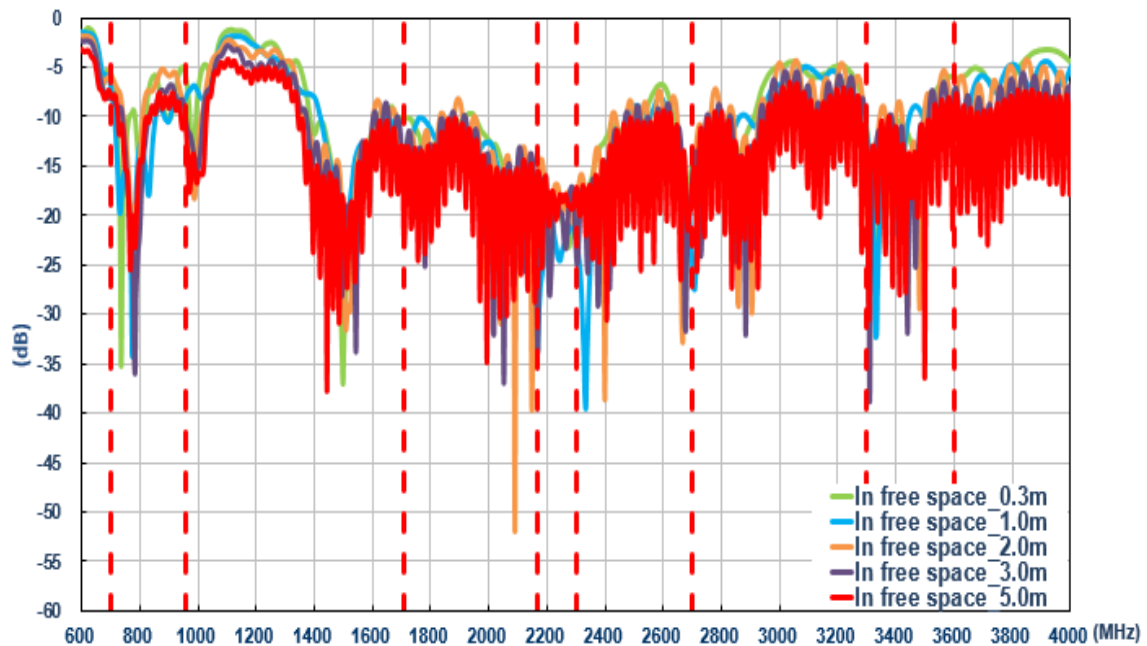

6.1.2 Return Loss (LTE MIMO 2)

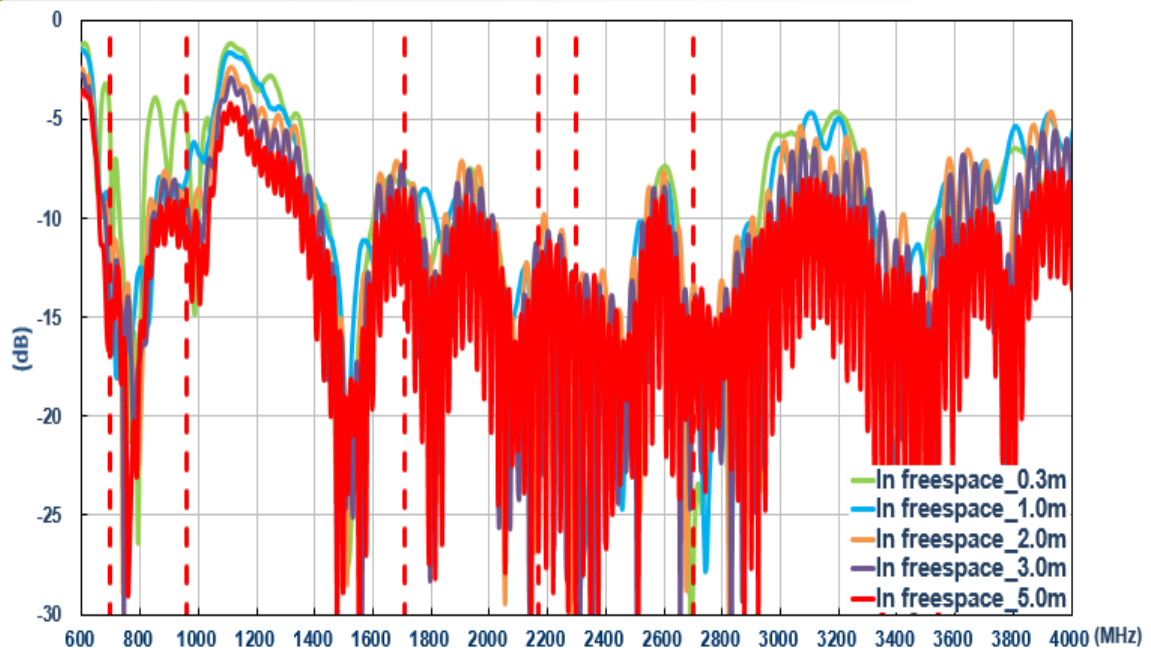

6.1.3 Isolation (LTE antenna)

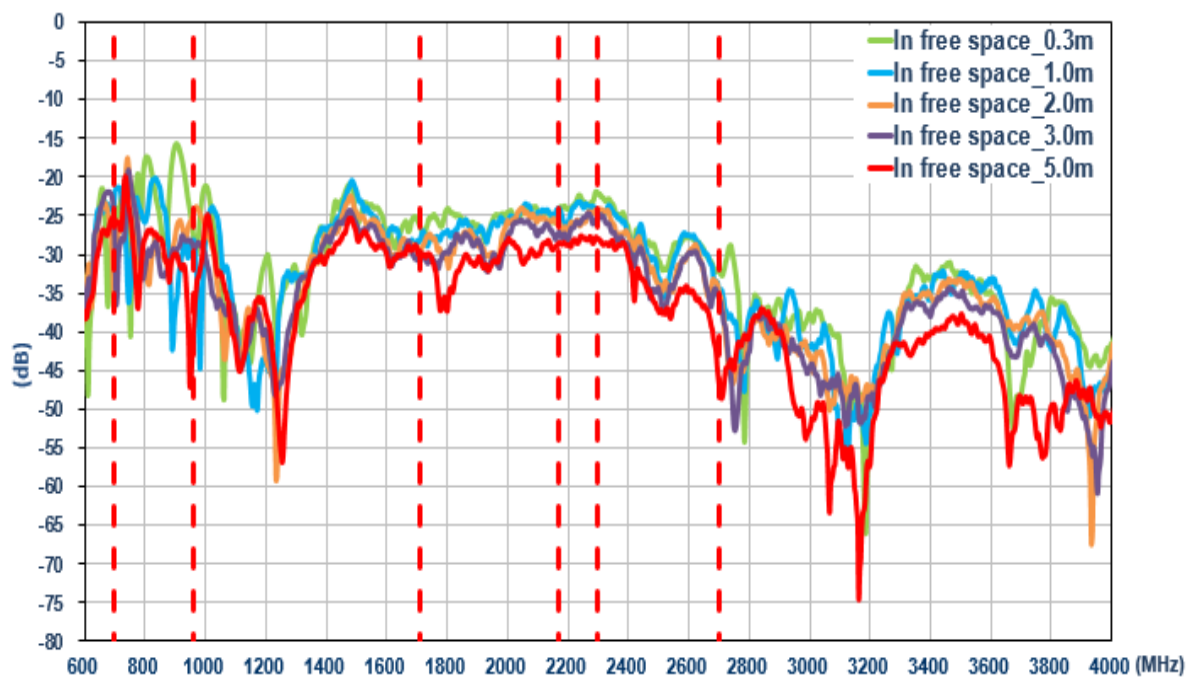

6.1.4 Return Loss (LTE MIMO 1)

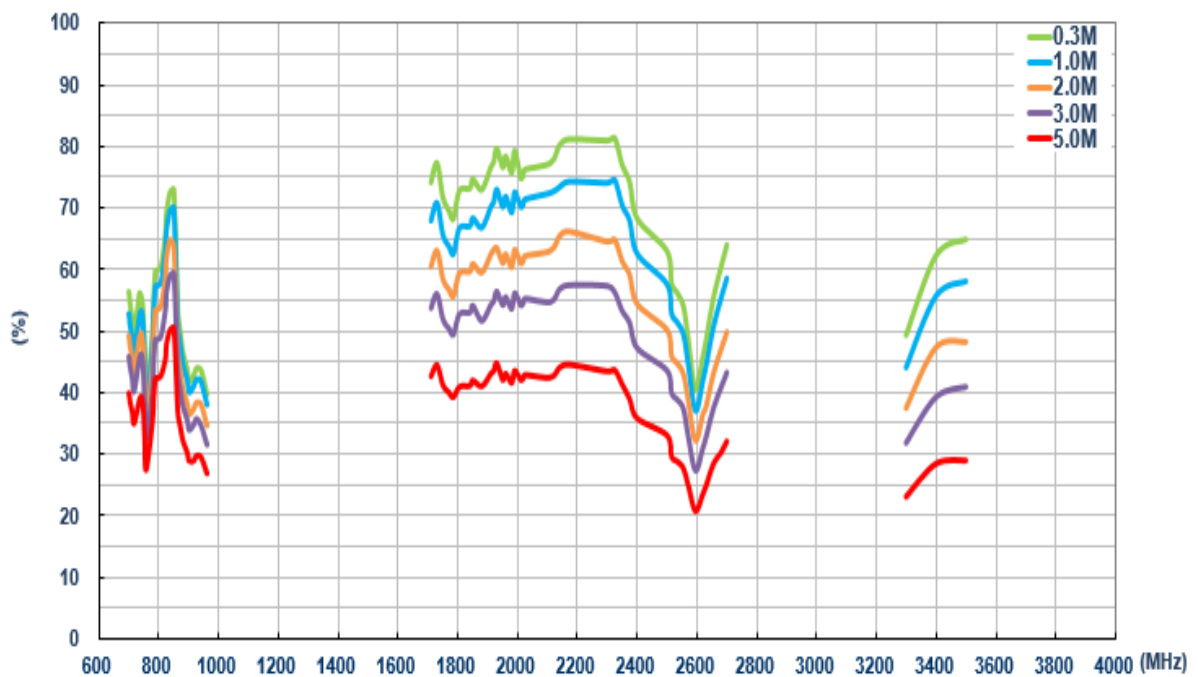

6.1.5 Efficiency (LTE MIMO 2)

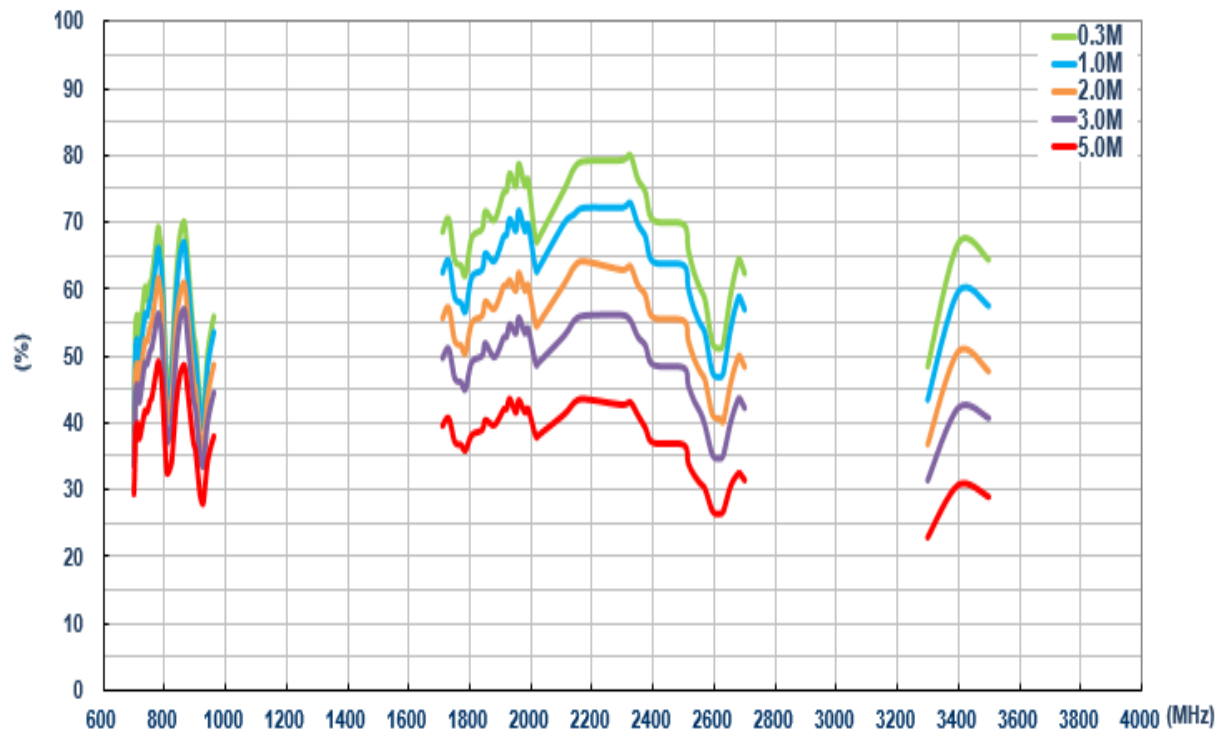

6.1.6 Average Gain (LTE MIMO 1)

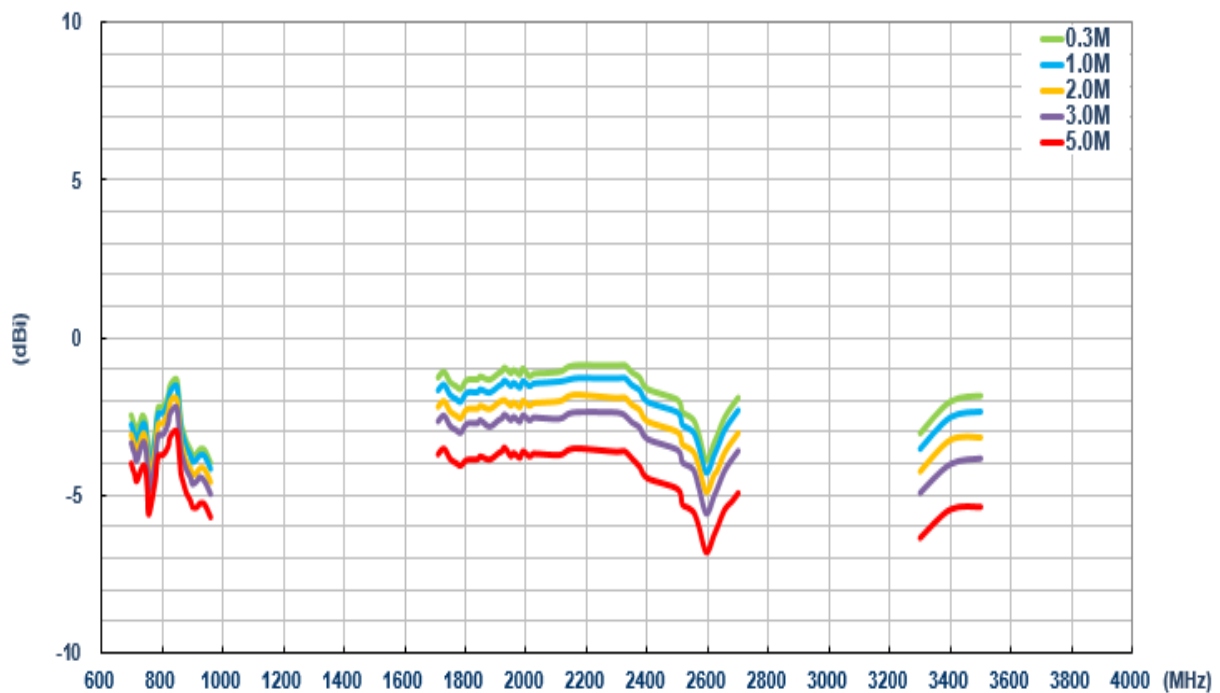

6.1.7 Average Gain (LTE MIMO 2)

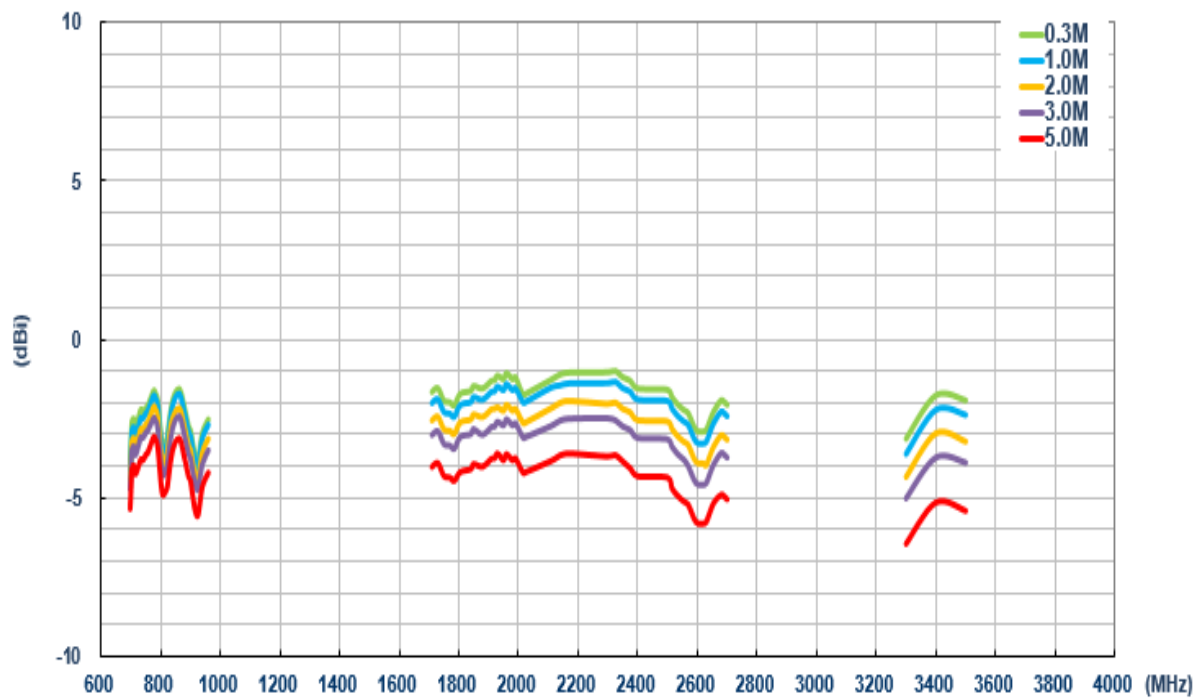

6.1.8 Peak Gain (LTE MIMO 1)

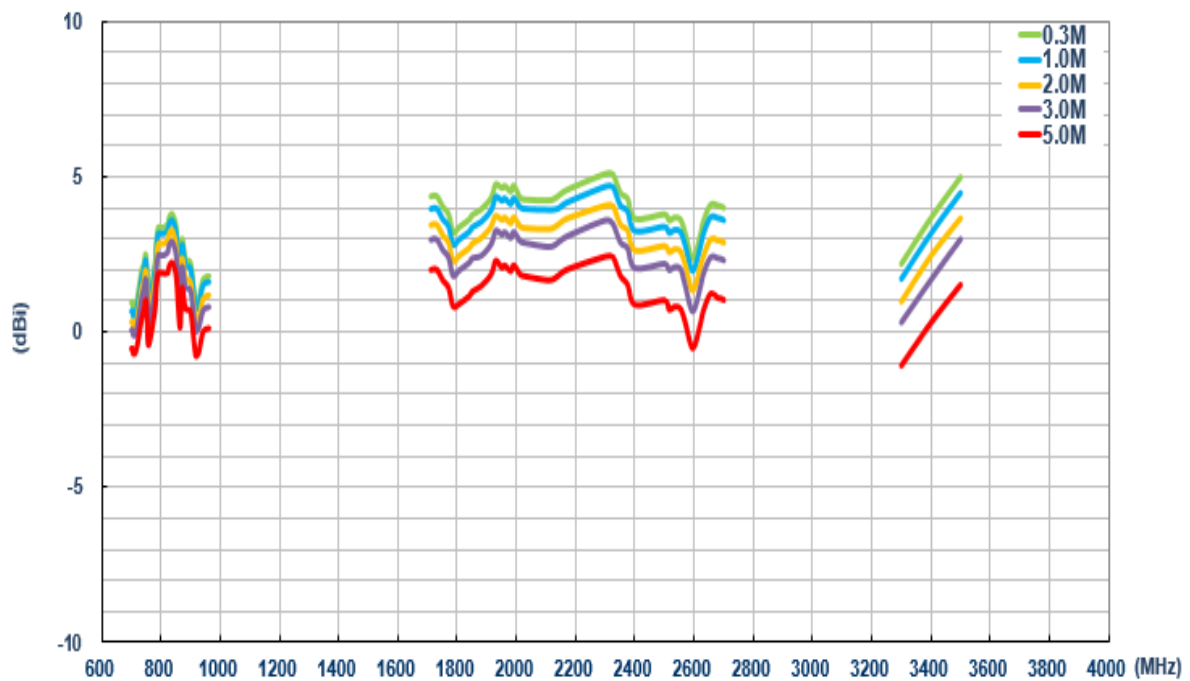

6.1.9 Peak Gain (LTE MIMO 2)

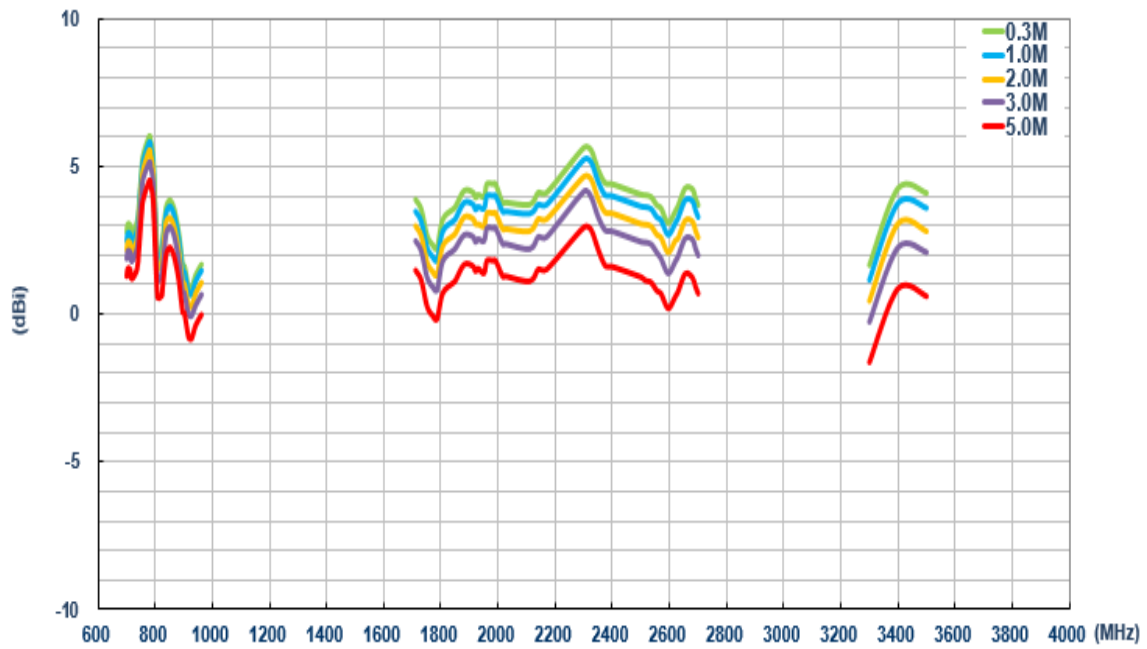

6.2 In free space (Wi-Fi)

6.2.1 Return Loss (Wi-Fi MIMO 1)

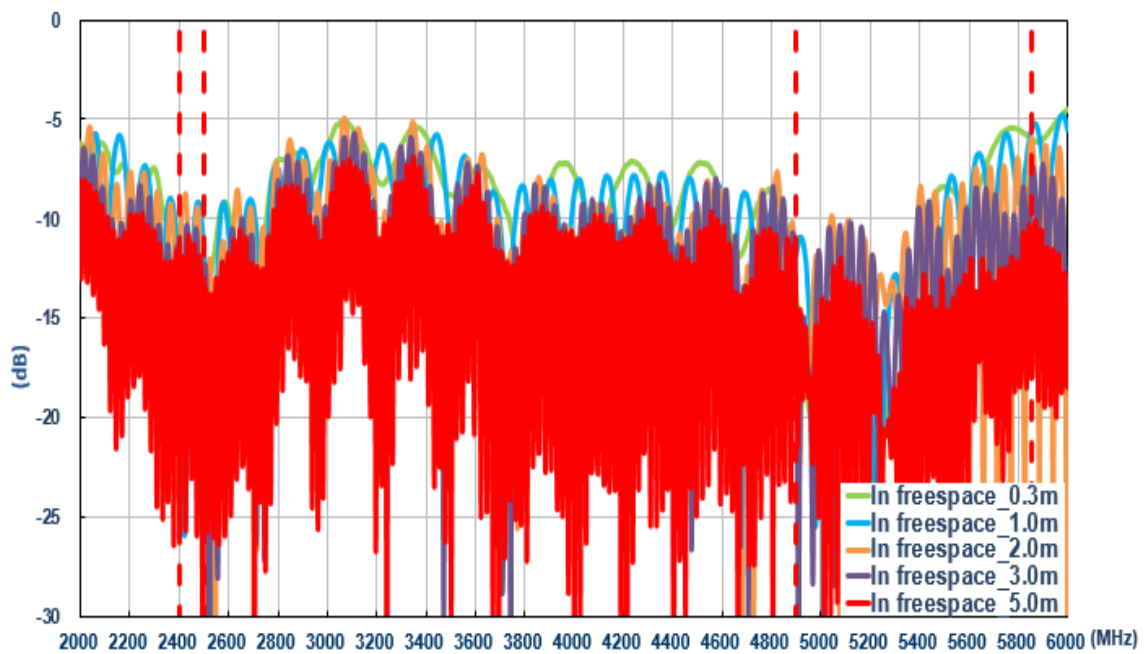

6.2.2 Return Loss (Wi-Fi MIMO 2)

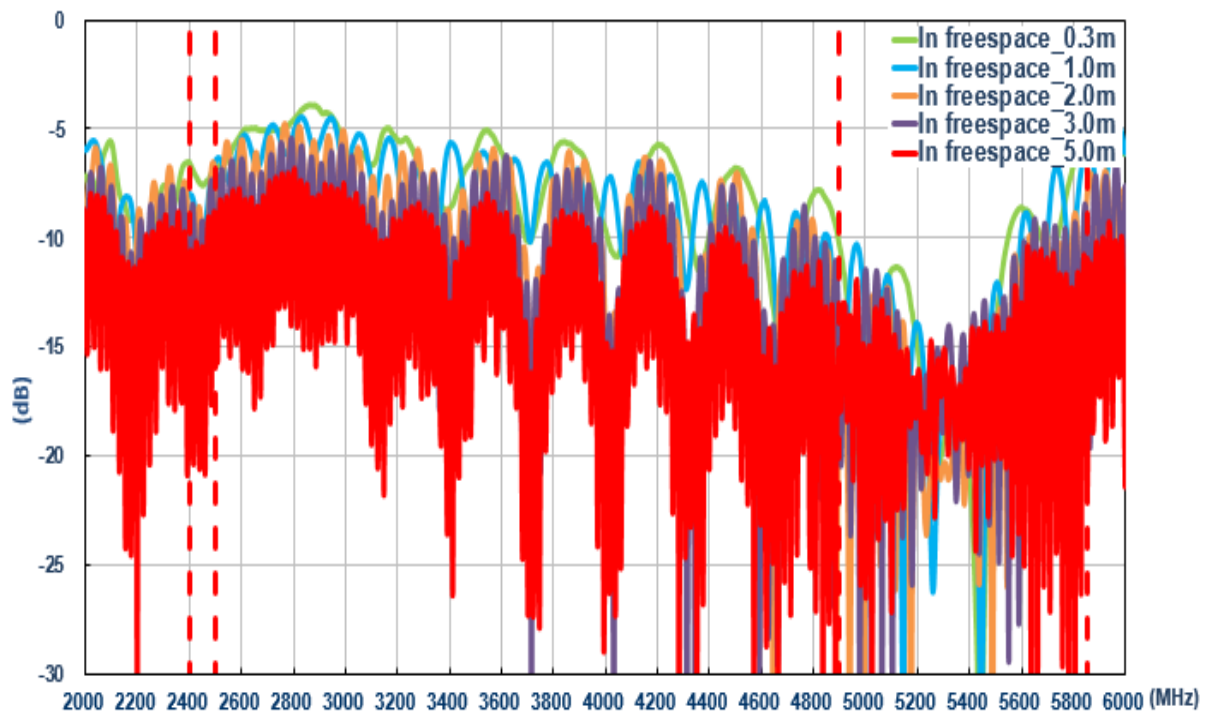

6.2.3 Isolation (Wi-Fi)

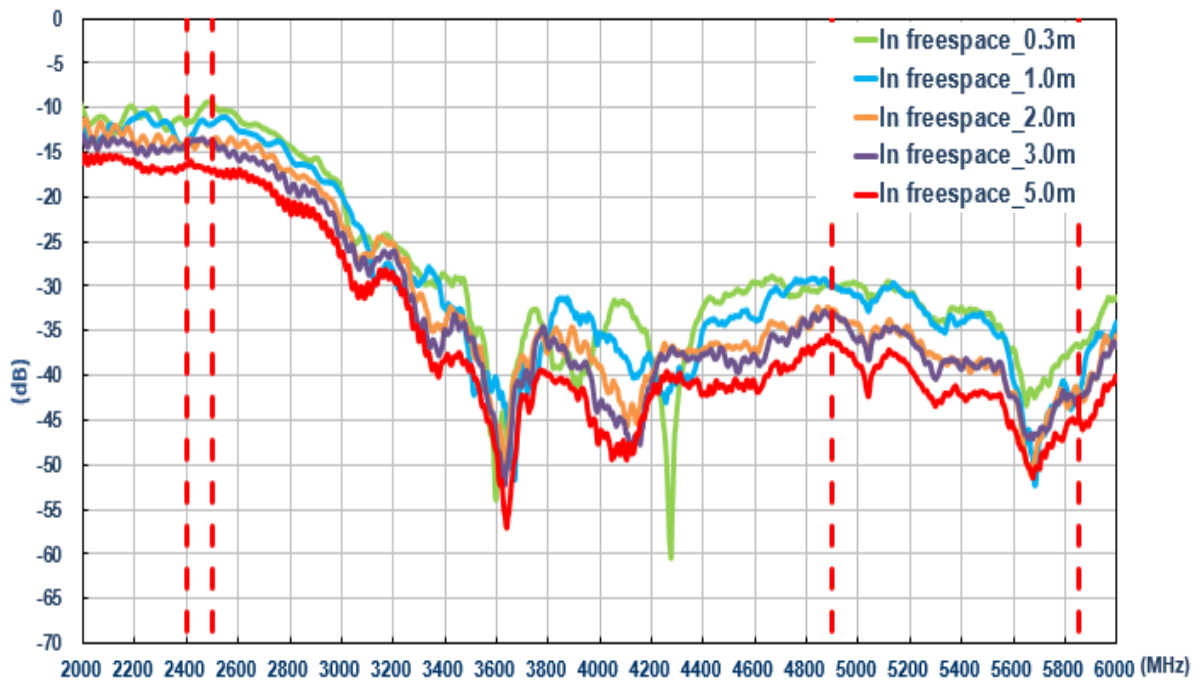

6.2.4 Efficiency (Wi-Fi MIMO 1)

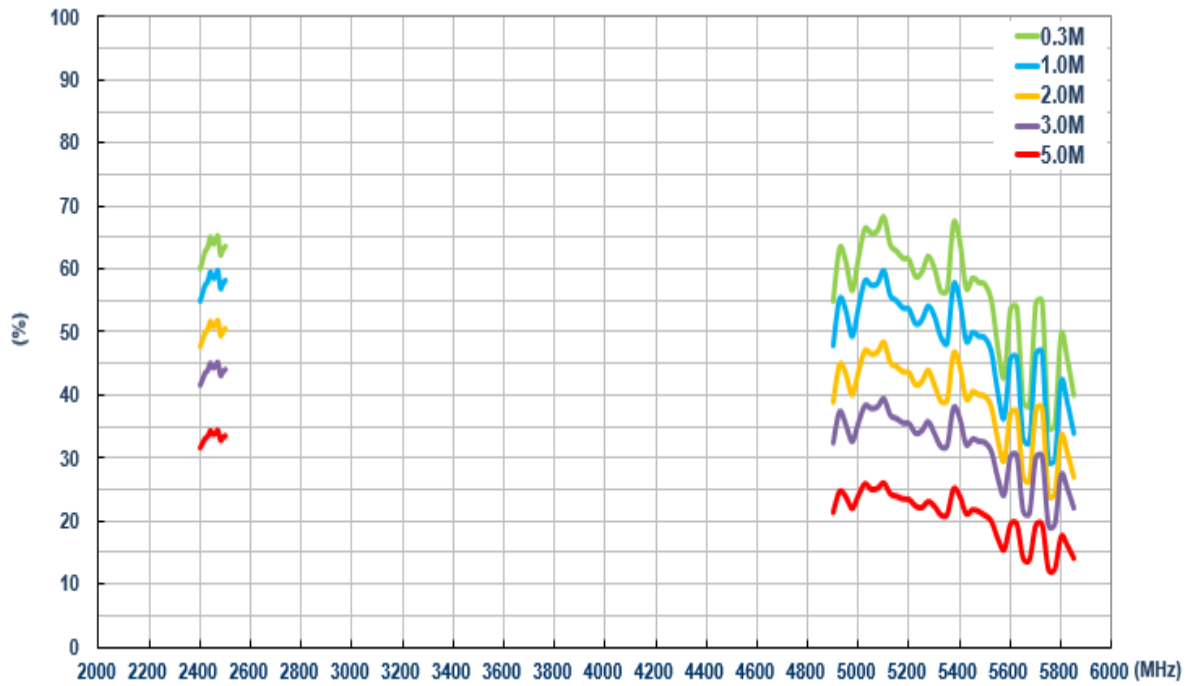

6.2.5 Efficiency (Wi-Fi MIMO 2)

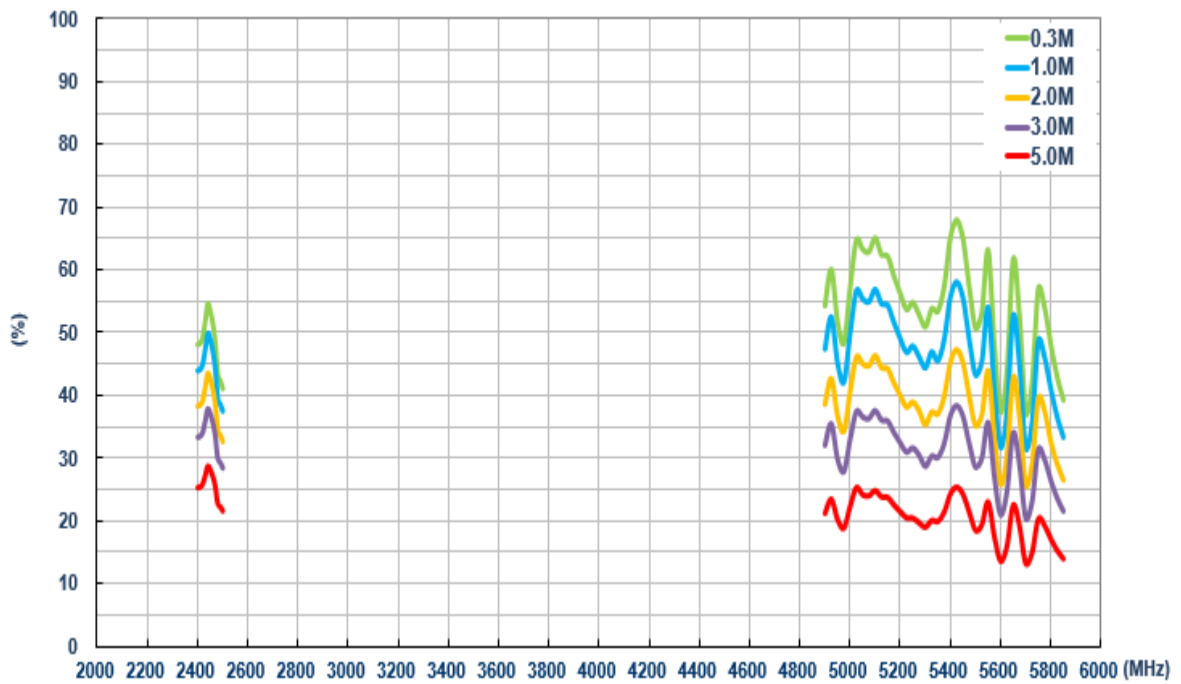

6.2.6 Average Gain (Wi-Fi MIMO 1)

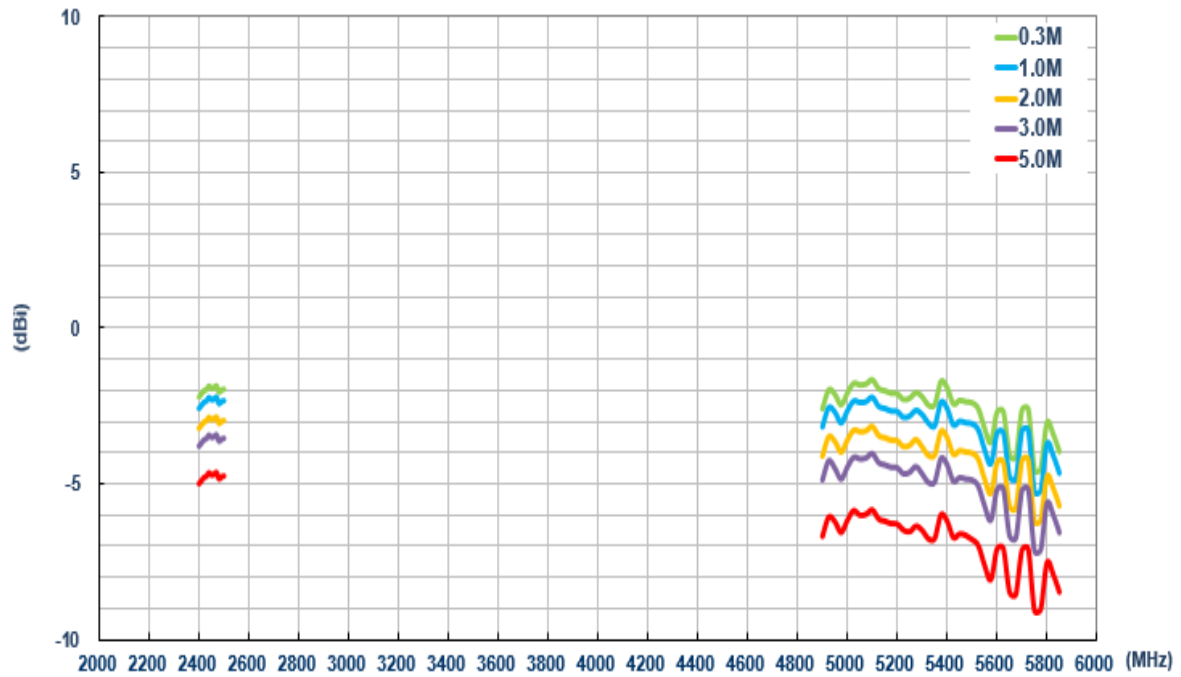

6.2.7 Average Gain (Wi-Fi MIMO 2)

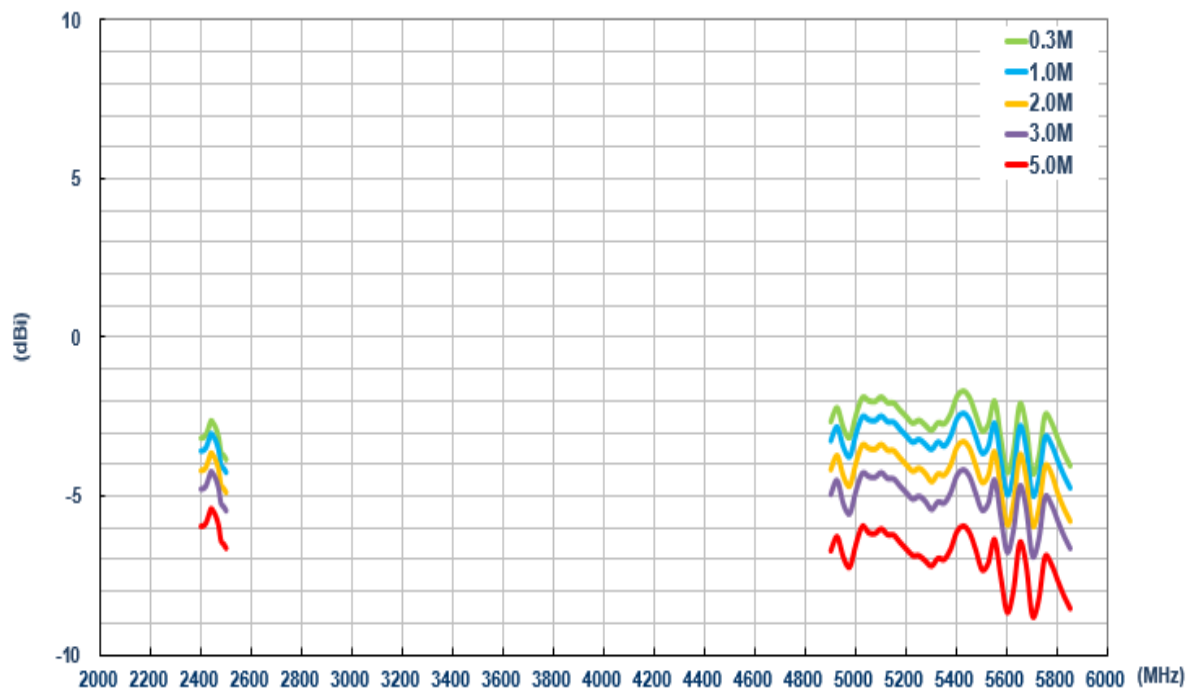

6.2.8 Peak Gain (Wi-Fi MIMO 1)

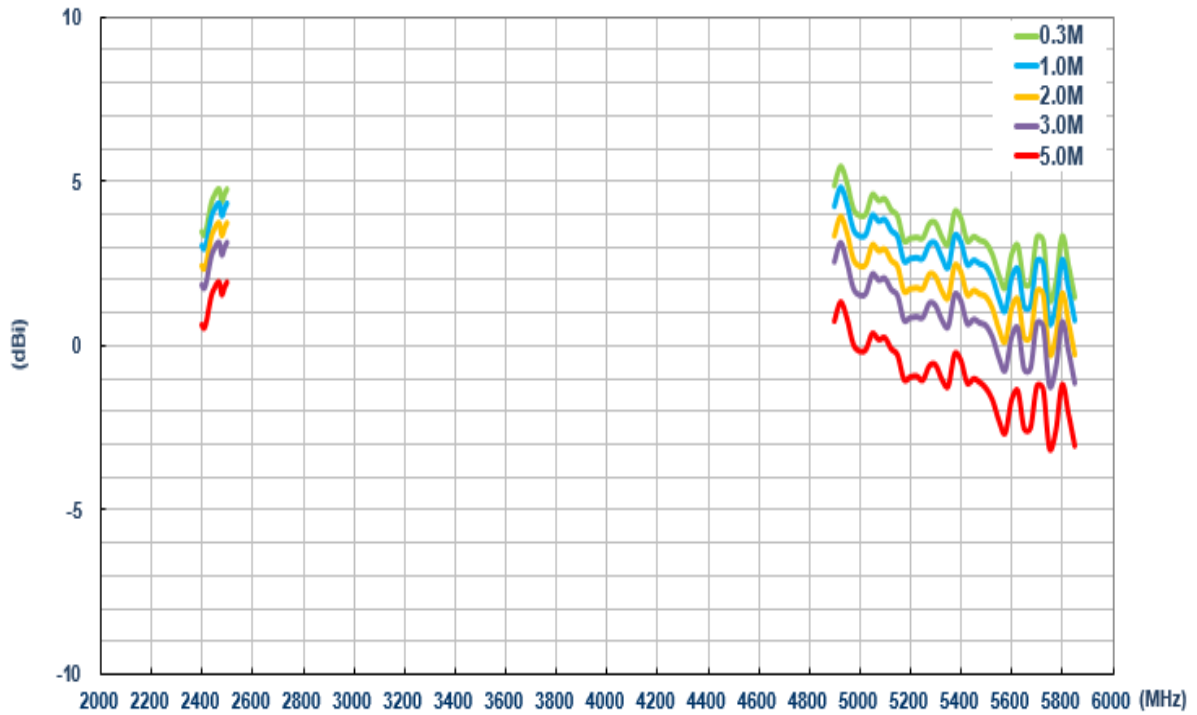

6.2.9 Peak Gain (Wi-Fi MIMO 2)

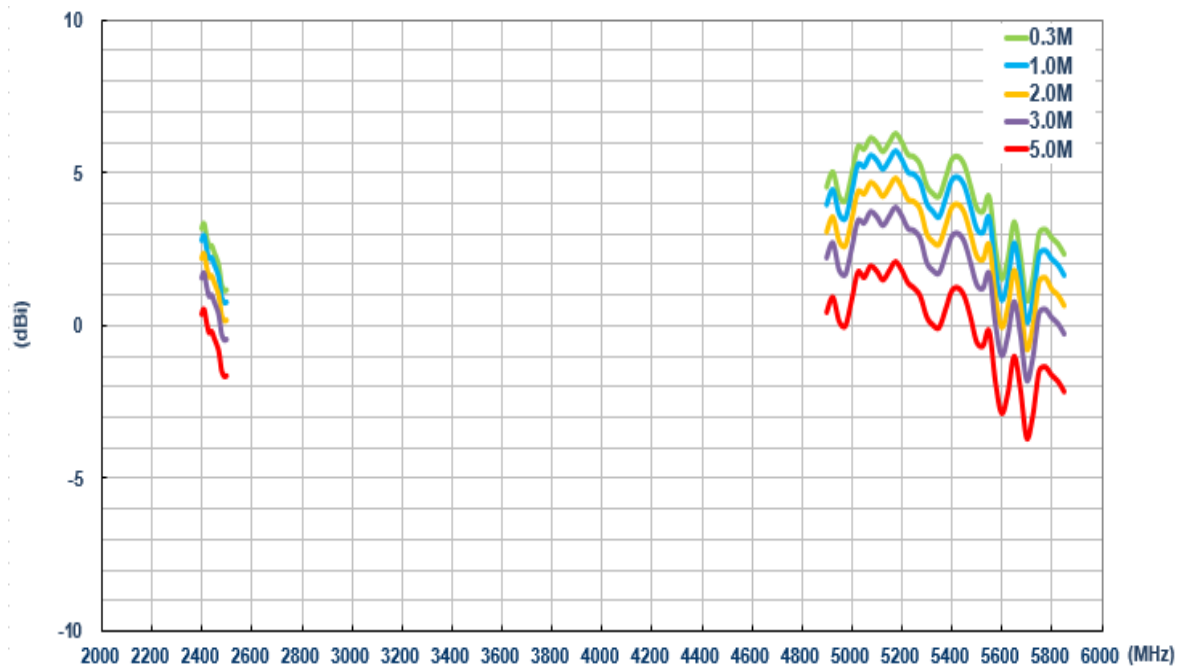

6.3 On the ABS (LTE)

6.3 Return Loss (LTE MIMO 1)

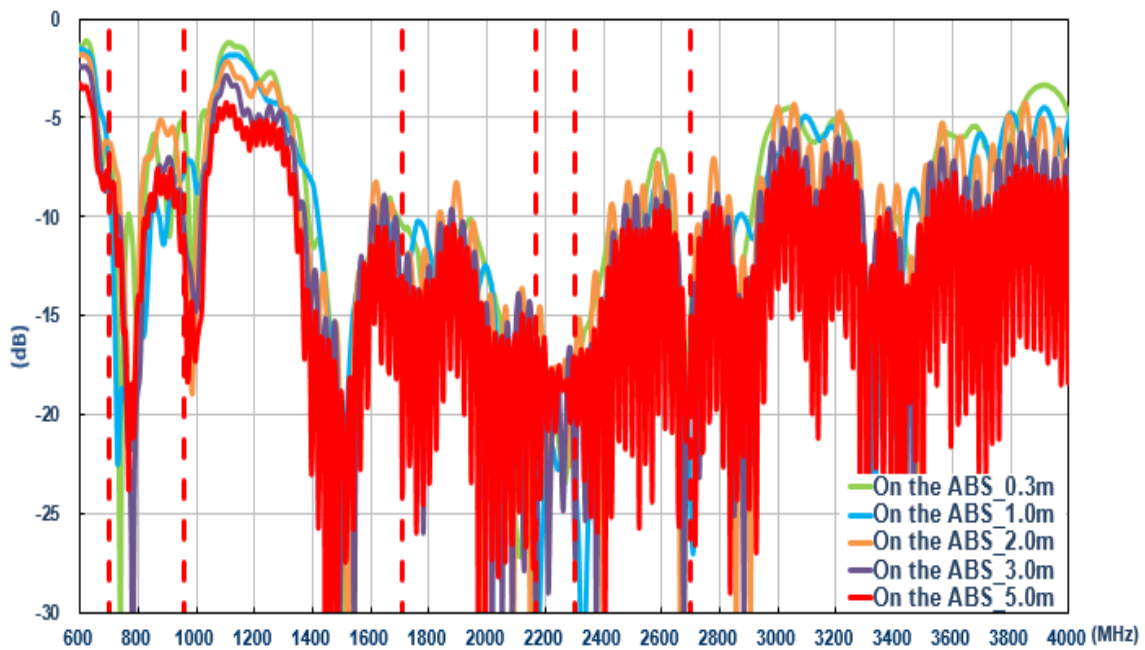

6.3.2 Return Loss (LTE MIMO 2)

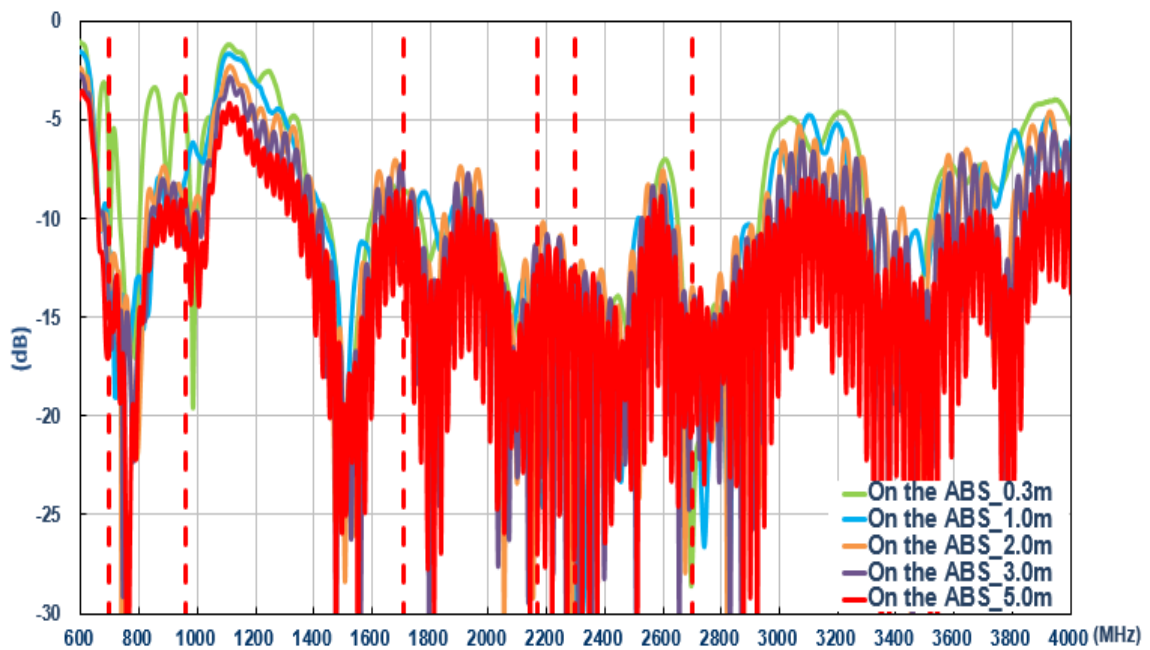

6.3.3 Isolation (LTE Antenna)

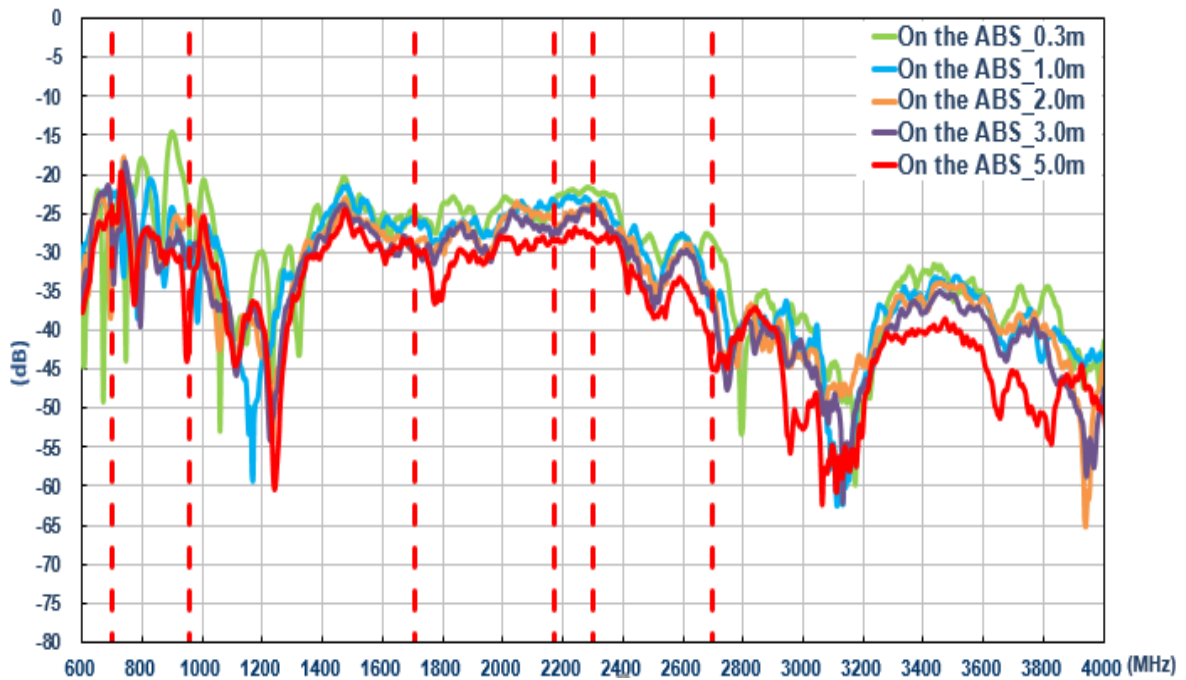

6.3.4 Efficiency (LTE MIMO 1)

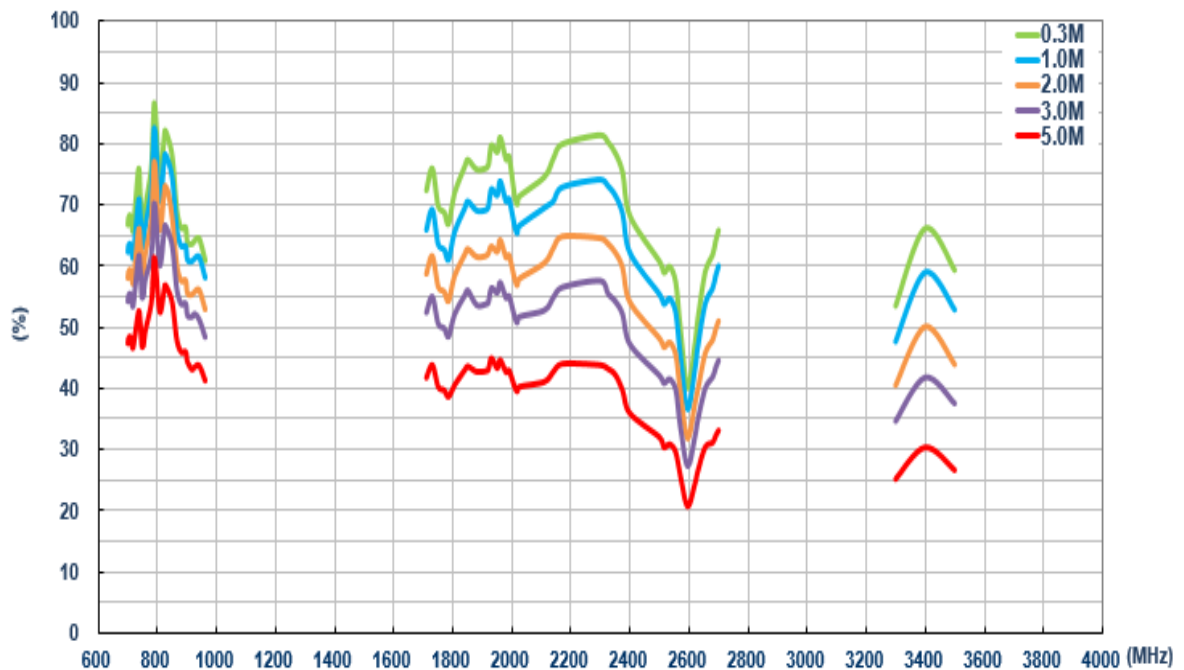

6.3.5 Efficiency (LTE MIMO 2)

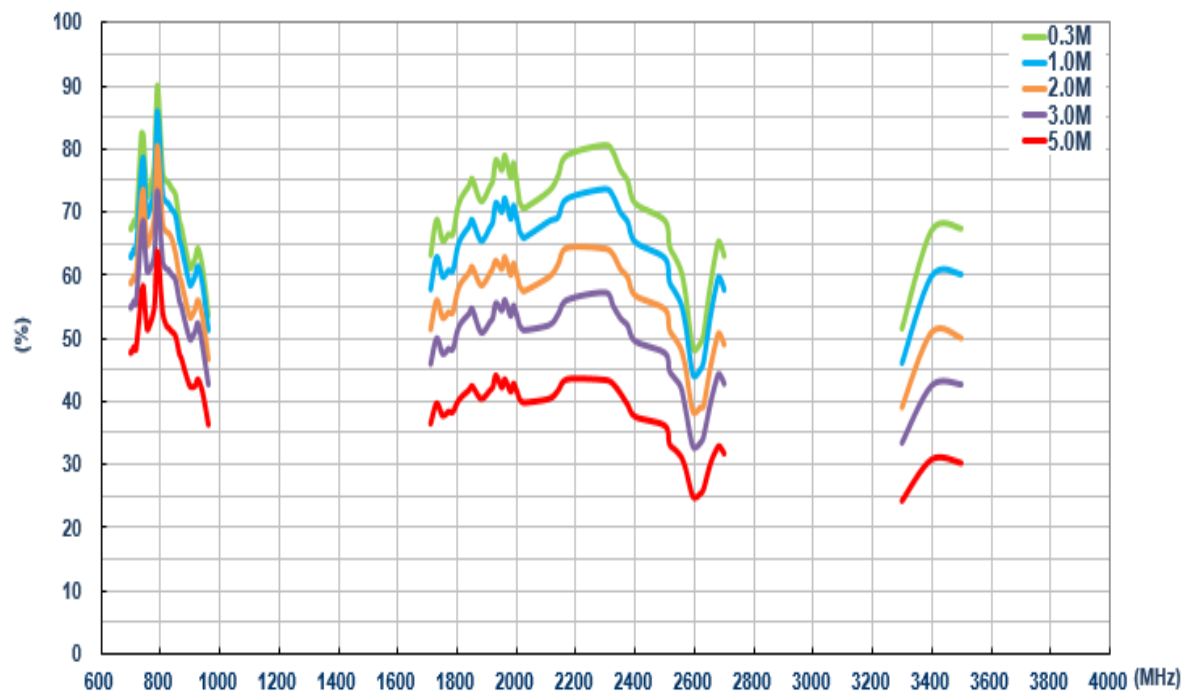

6.3.6 Average Gain (LTE MIMO 1)

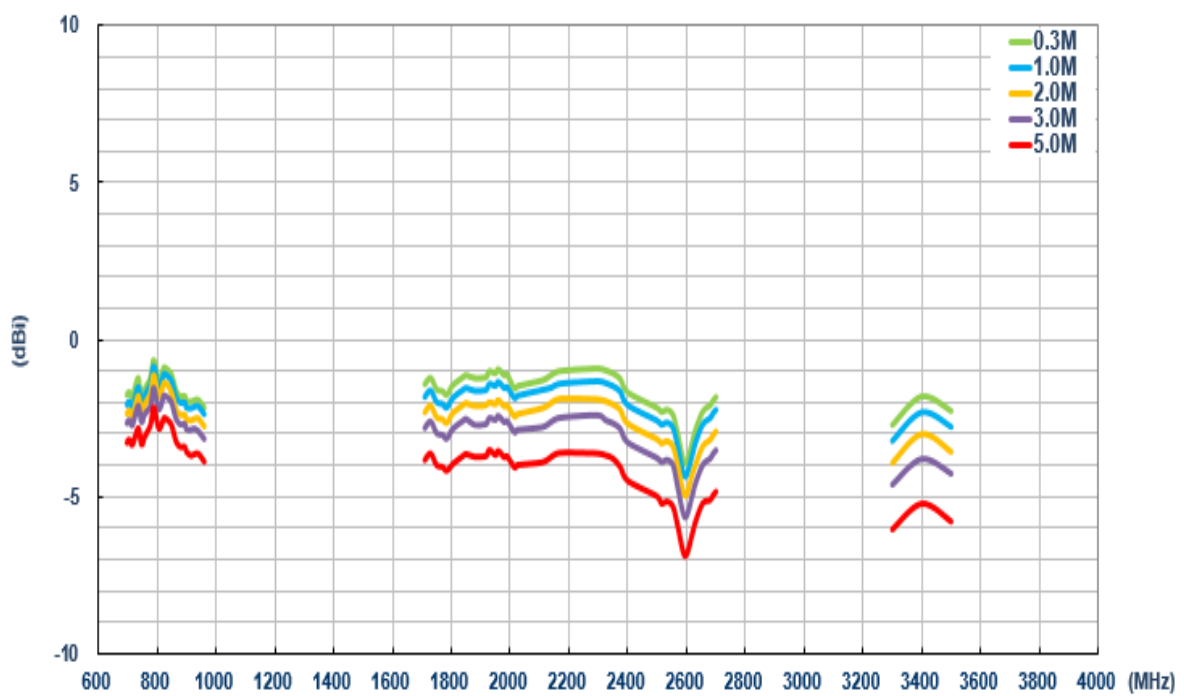

6.3.7 Average Gain (LTE MIMO 2)

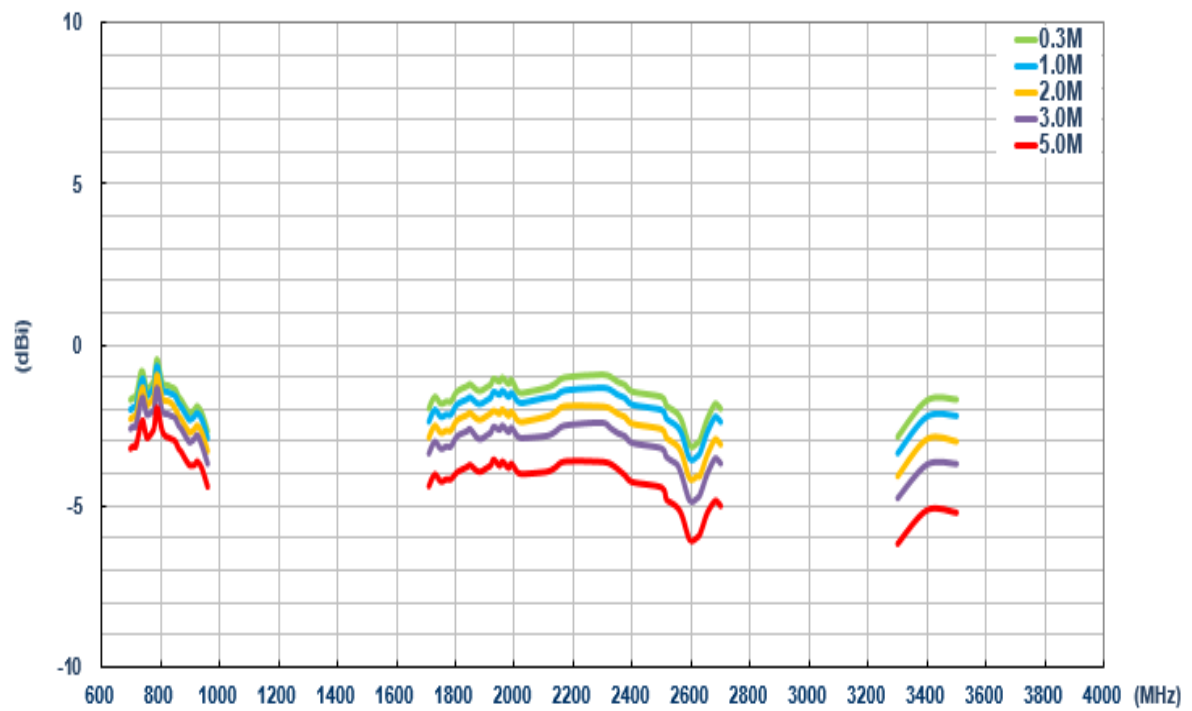

6.3.8 Peak Gain (LTE MIMO 1)

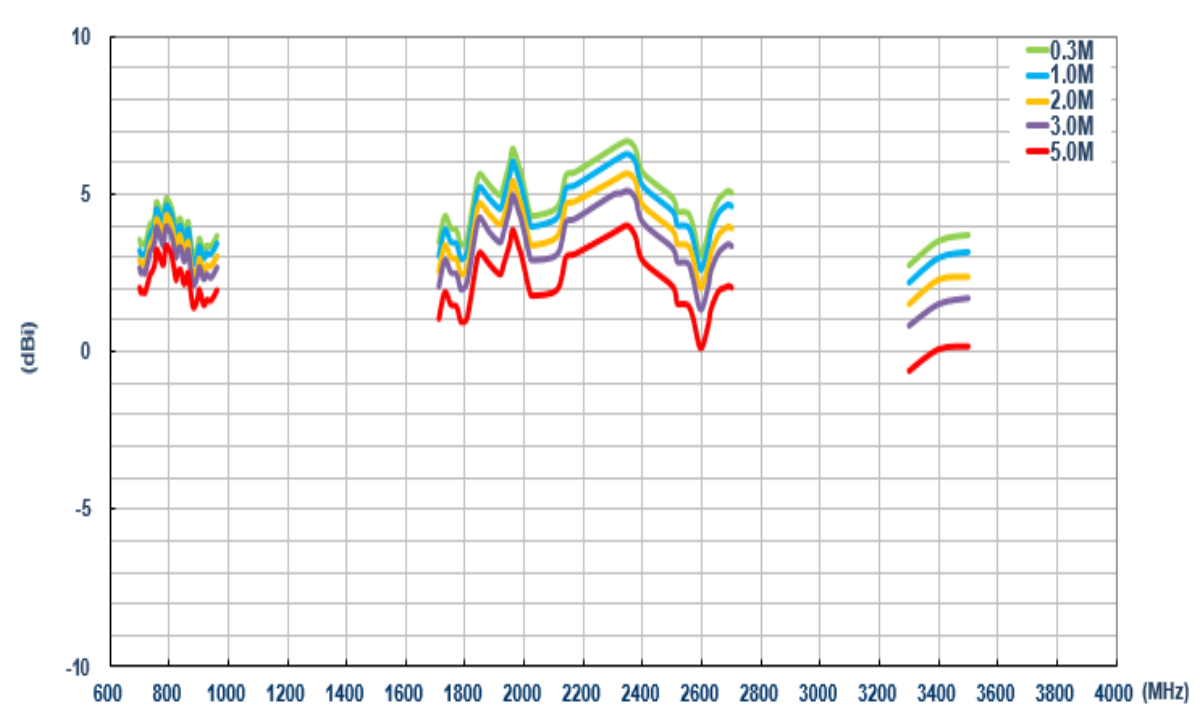

6.3.9 Peak Gain (LTE MIMO 2)

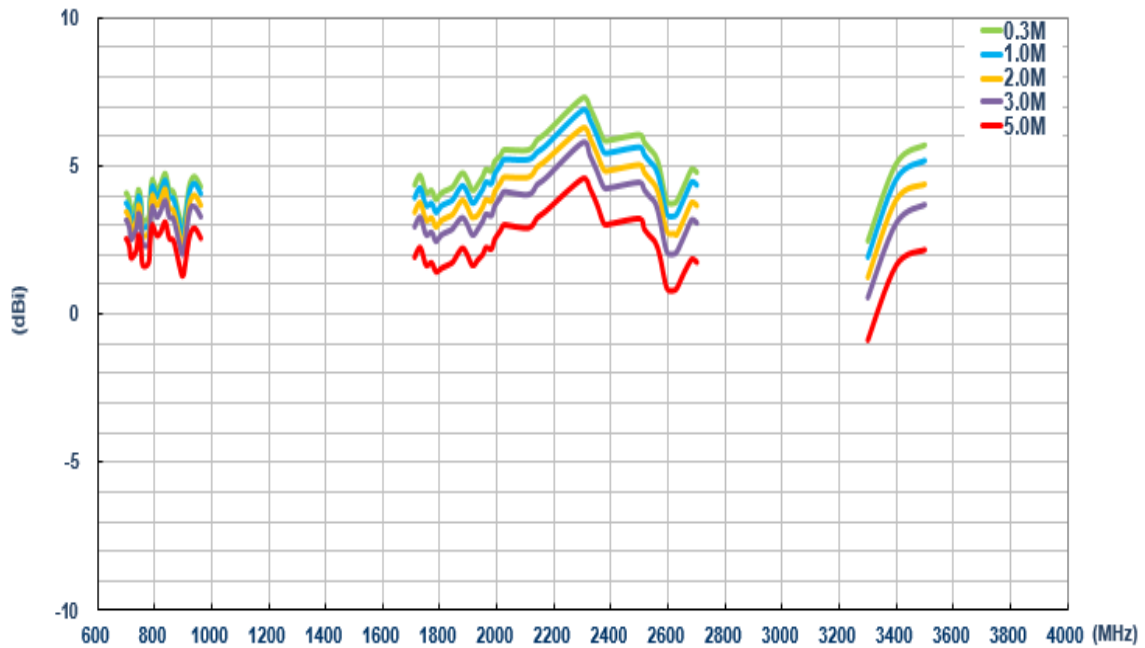

6.4 On ABS (Wi-Fi)

6.4.1 Return Loss (Wi-Fi MIMO 1)

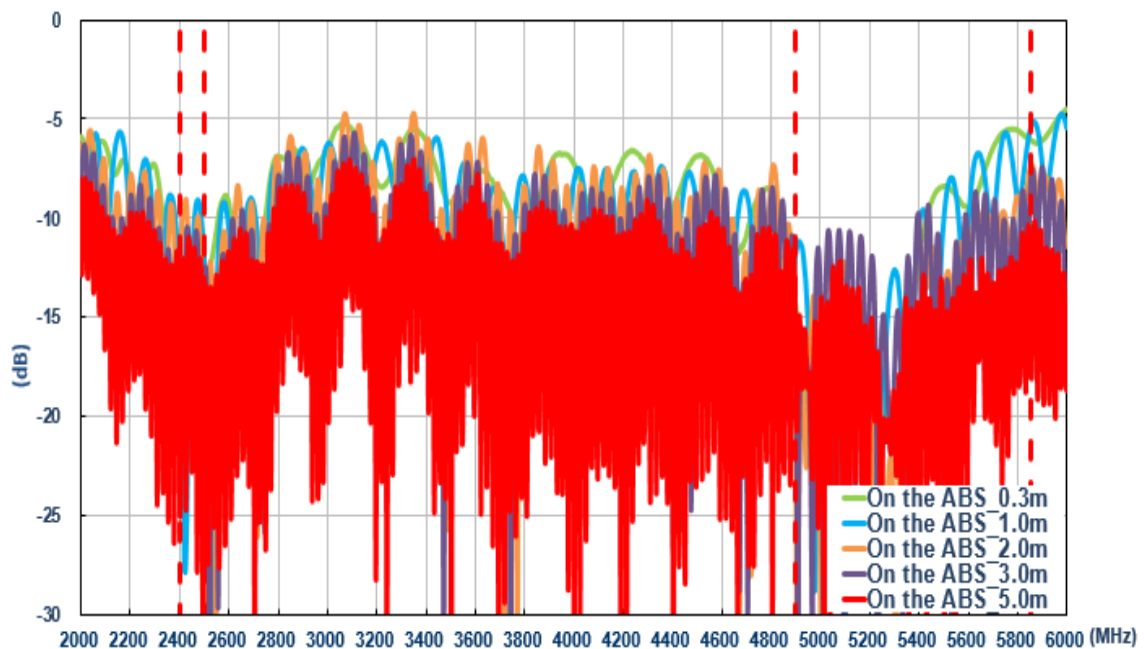

6.4.2 Return Loss (Wi-Fi MIMO 2)

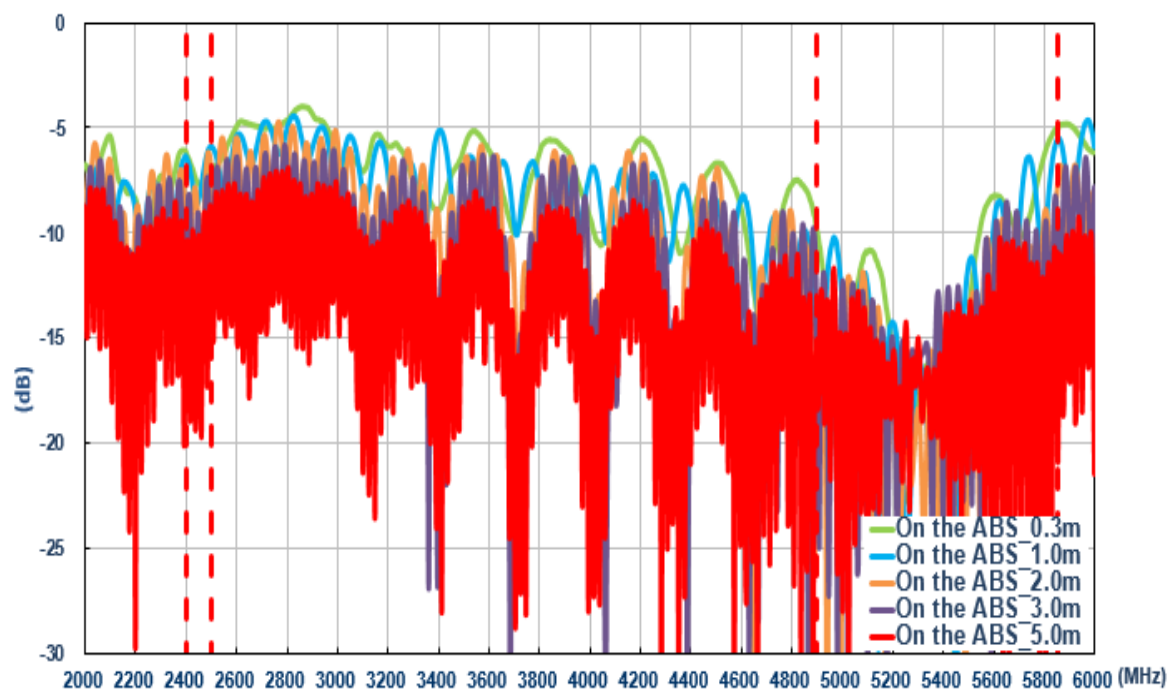

6.4.3 Isolation (Wi-Fi)

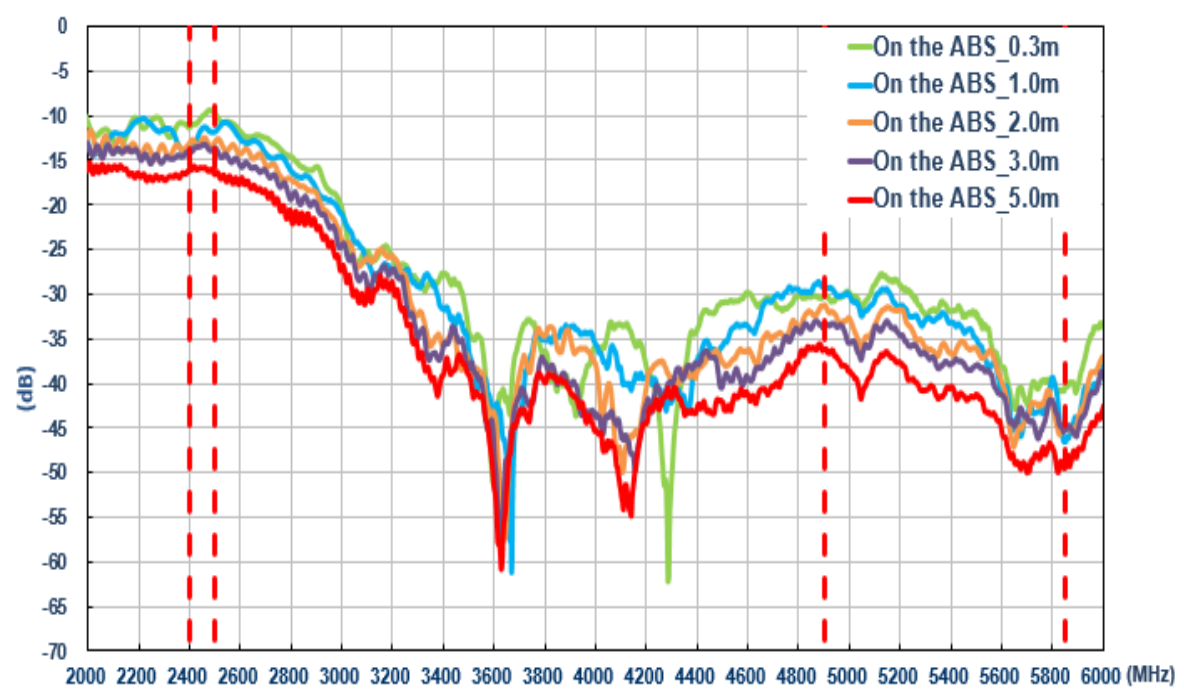

6.4.4 Return Loss (Wi-Fi MIMO 2)

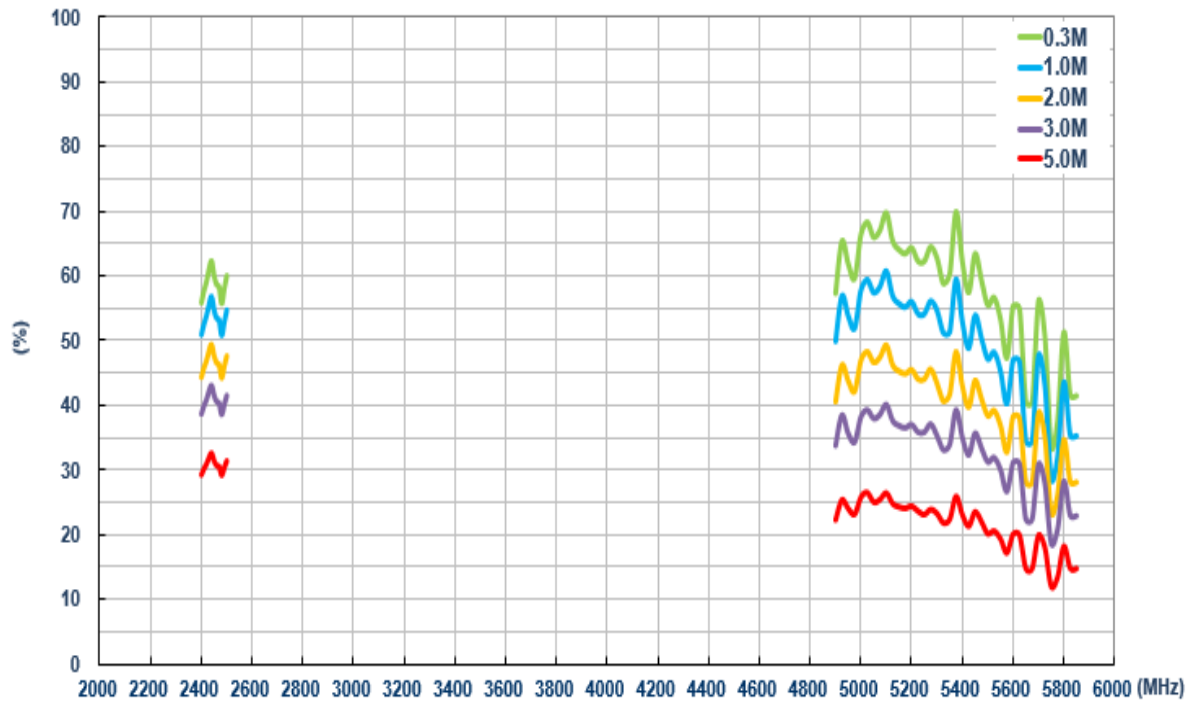

6.4.5 Isolation (Wi-Fi)

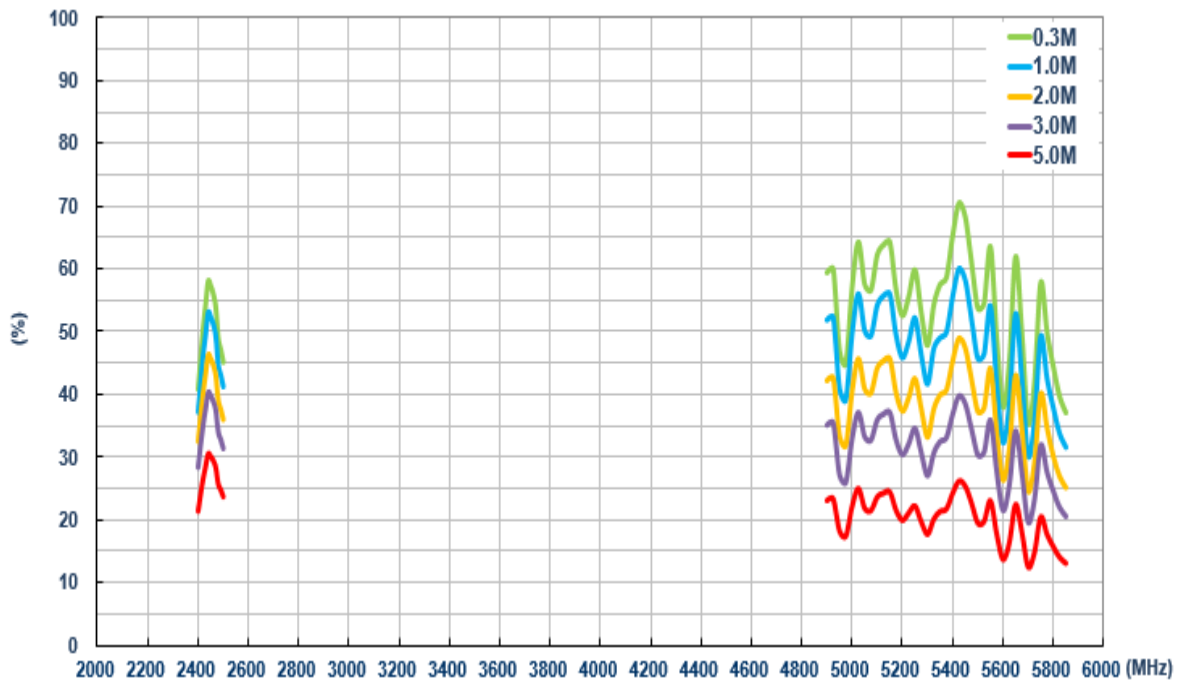

6.4.6 Average Gain (Wi-Fi MIMO 1)

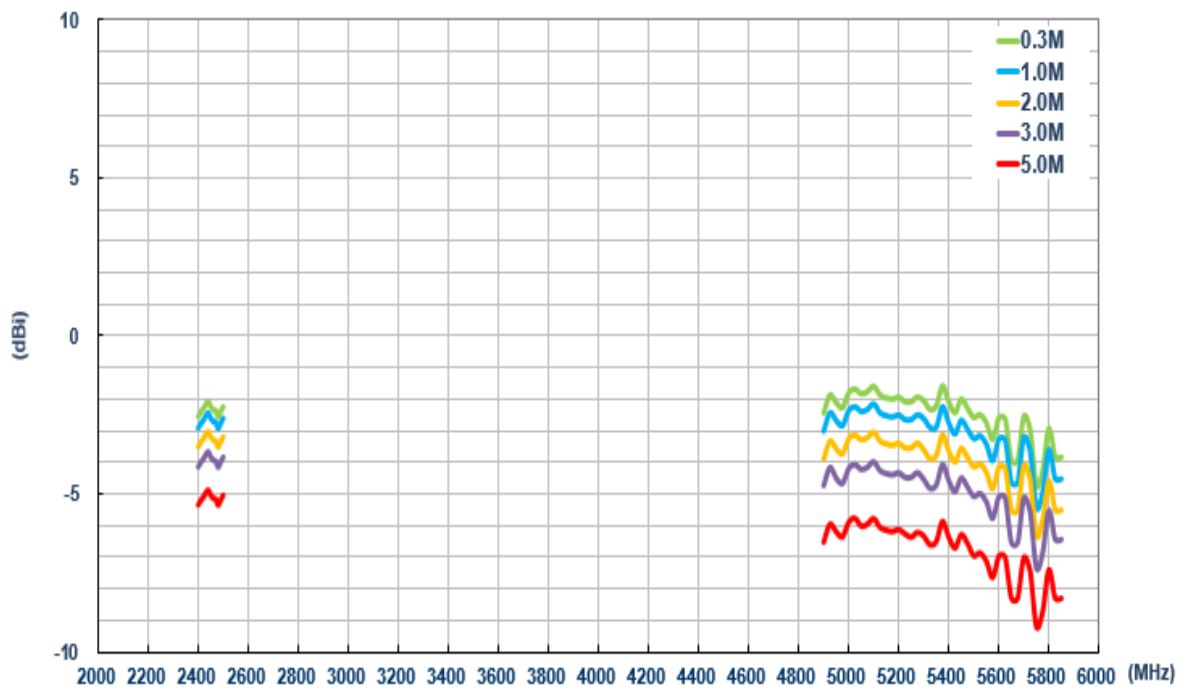

6.4.7 Average Gain (Wi-Fi MIMO 2)

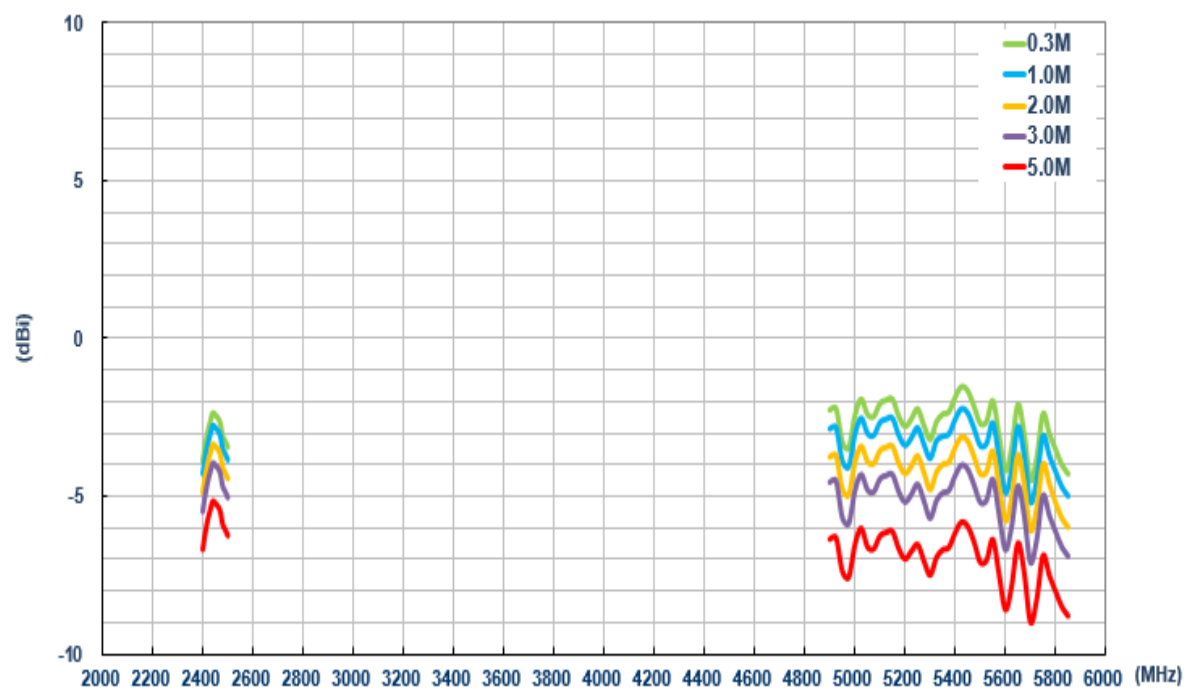

6.4.8 Peak Gain (Wi-Fi MIMO 1)

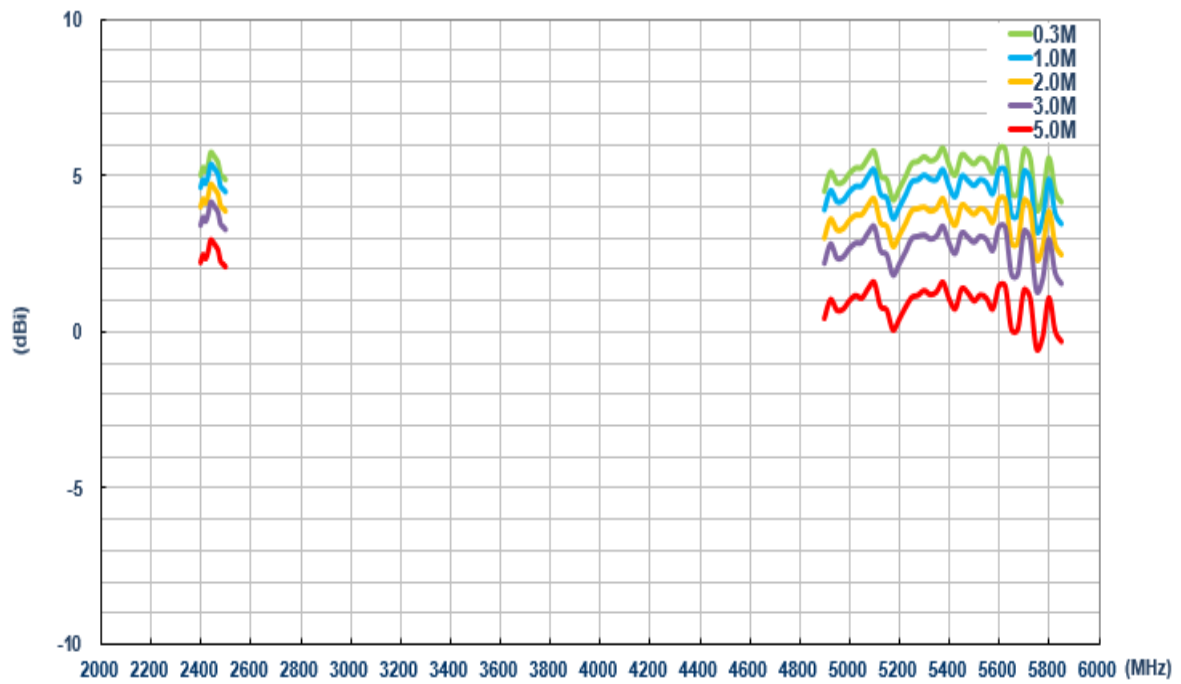

6.4.9 Peak Gain (Wi-Fi MIMO 2)

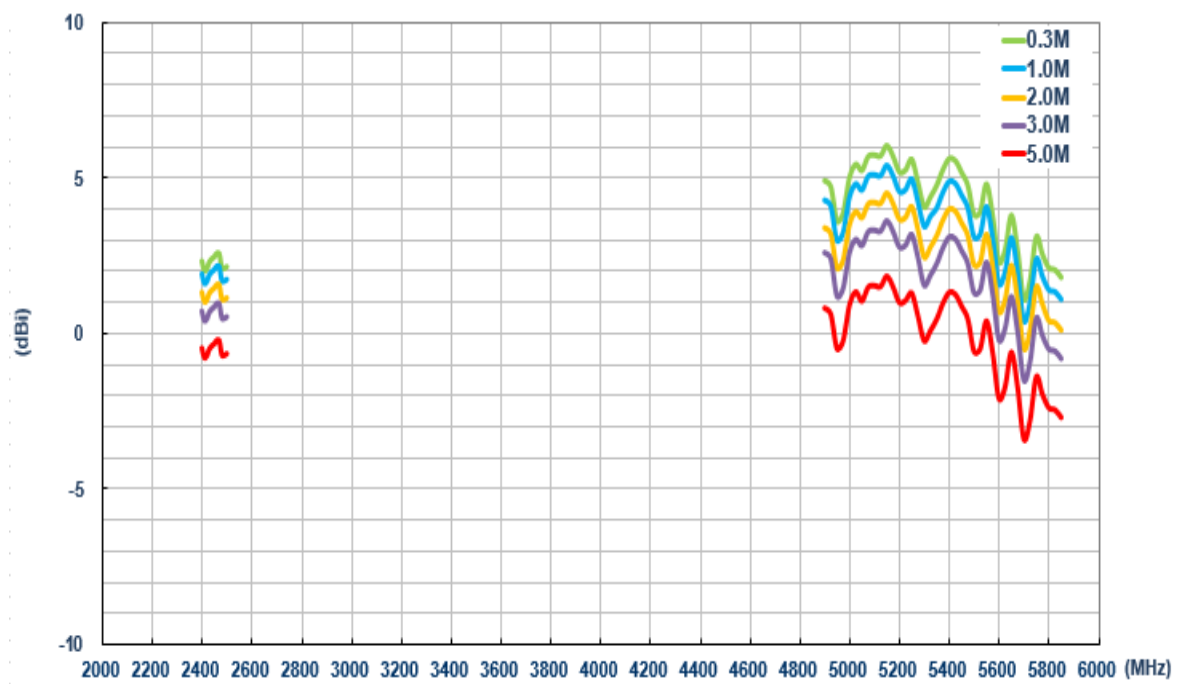

6.5. On glass

6.5.1 Return Loss (LTE_MIMO 1)

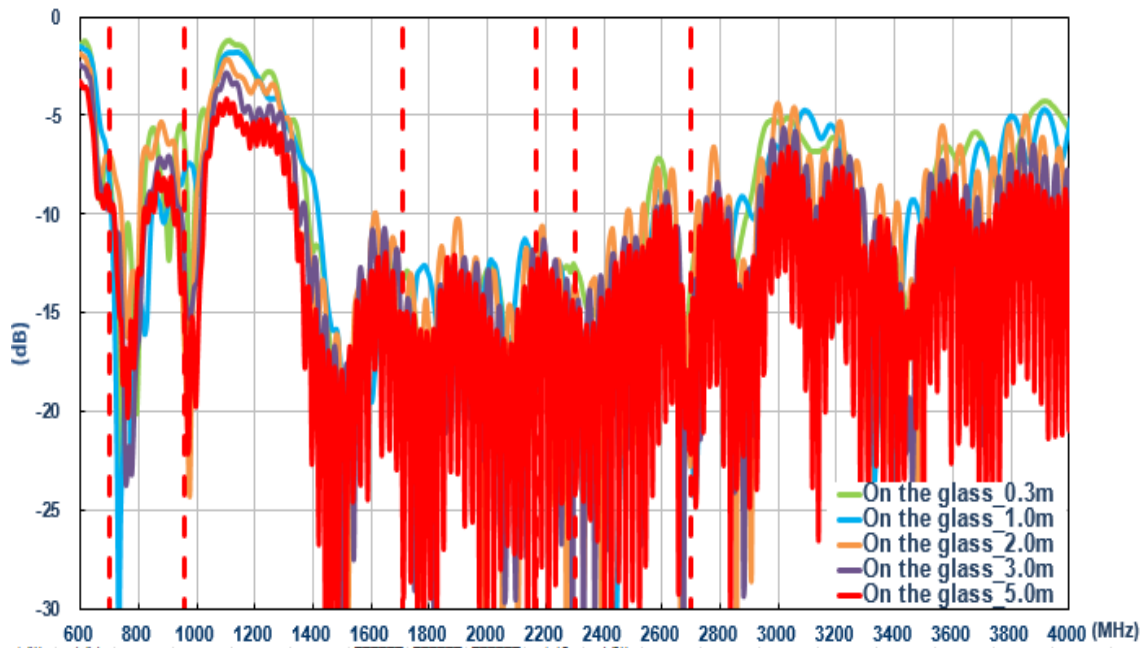

6.5.2 Return Loss (LTE_MIMO 2)

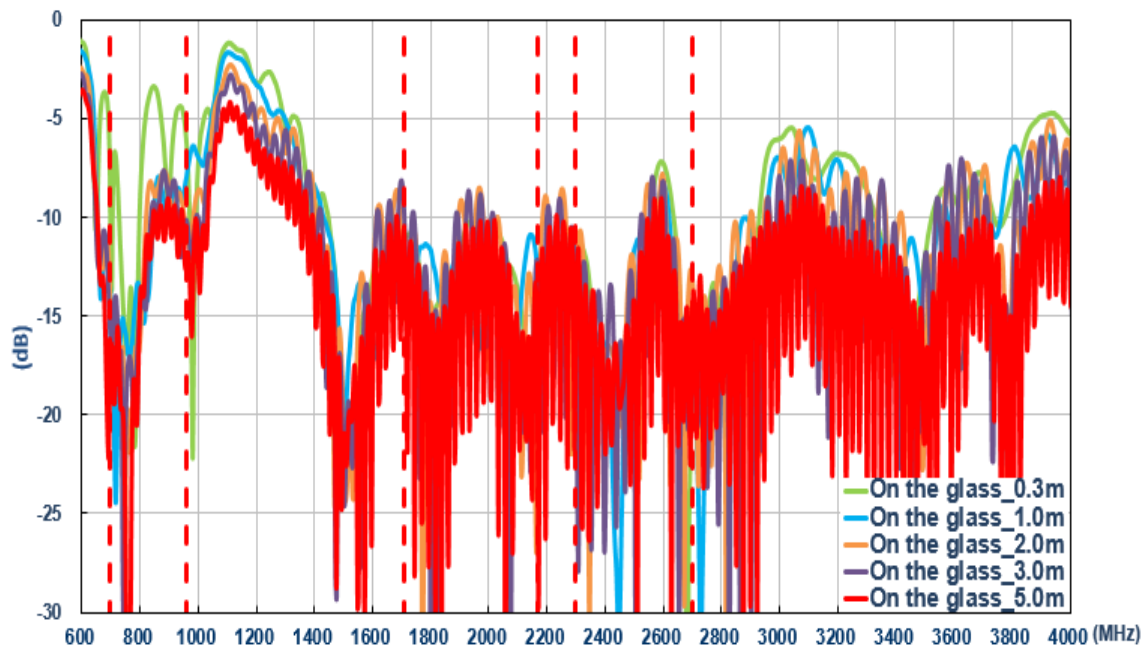

6.5.3 Isolation (LTE antenna)

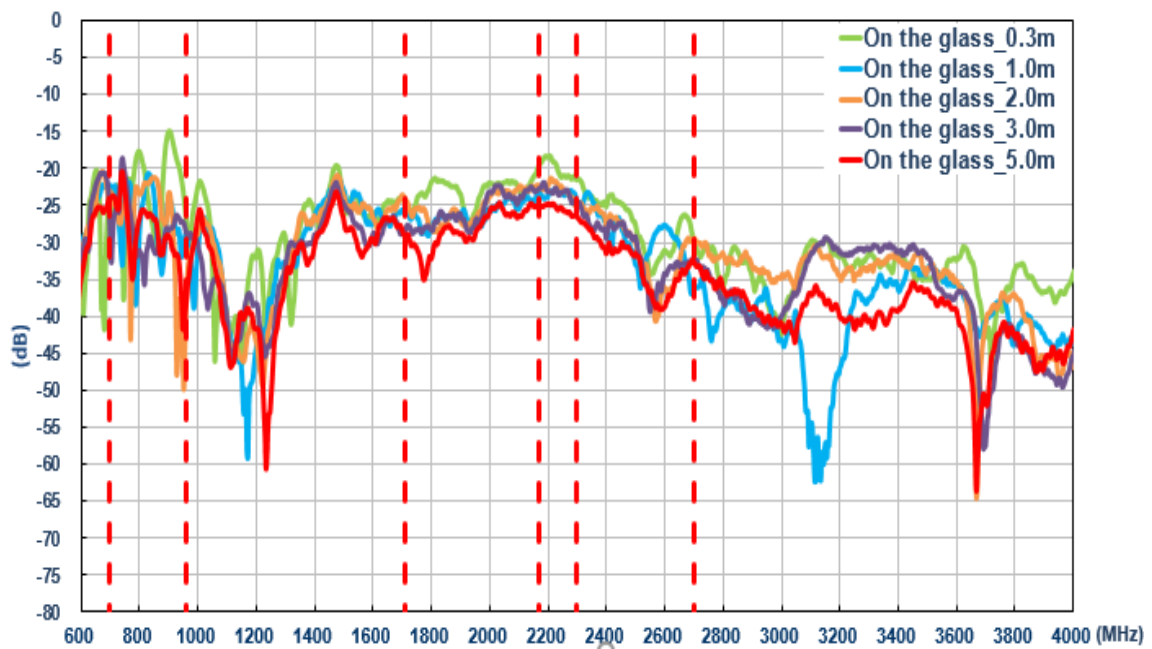

6.5.4 Efficiency (LTE MIMO 1)

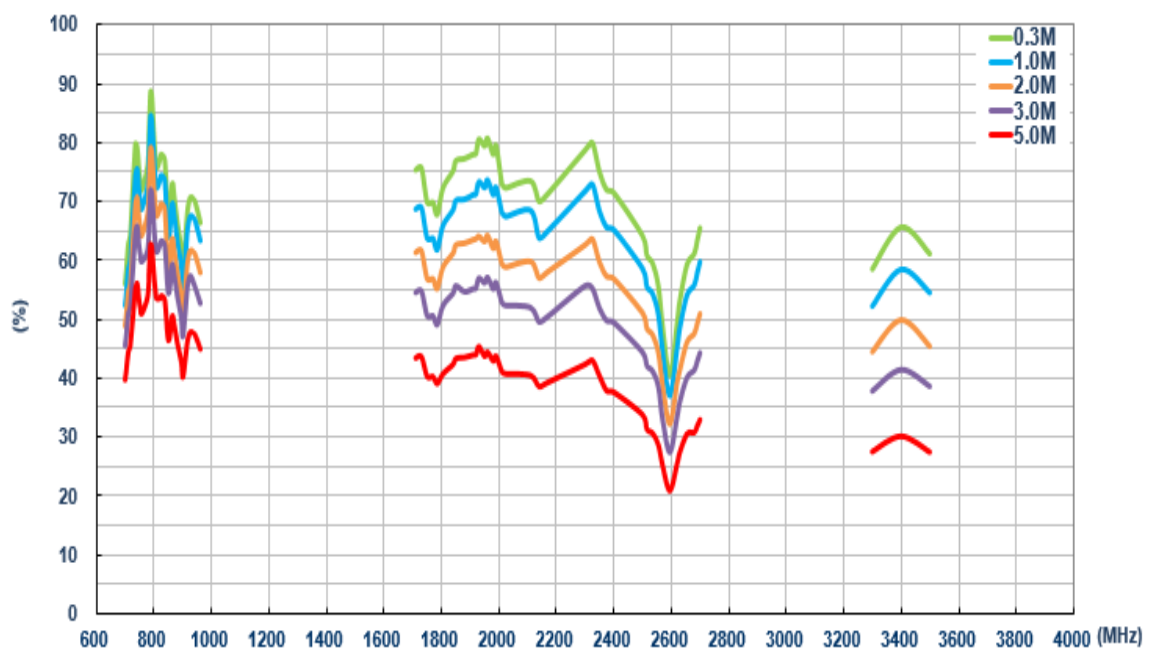

6.5.5 Efficiency (LTE MIMO 2)

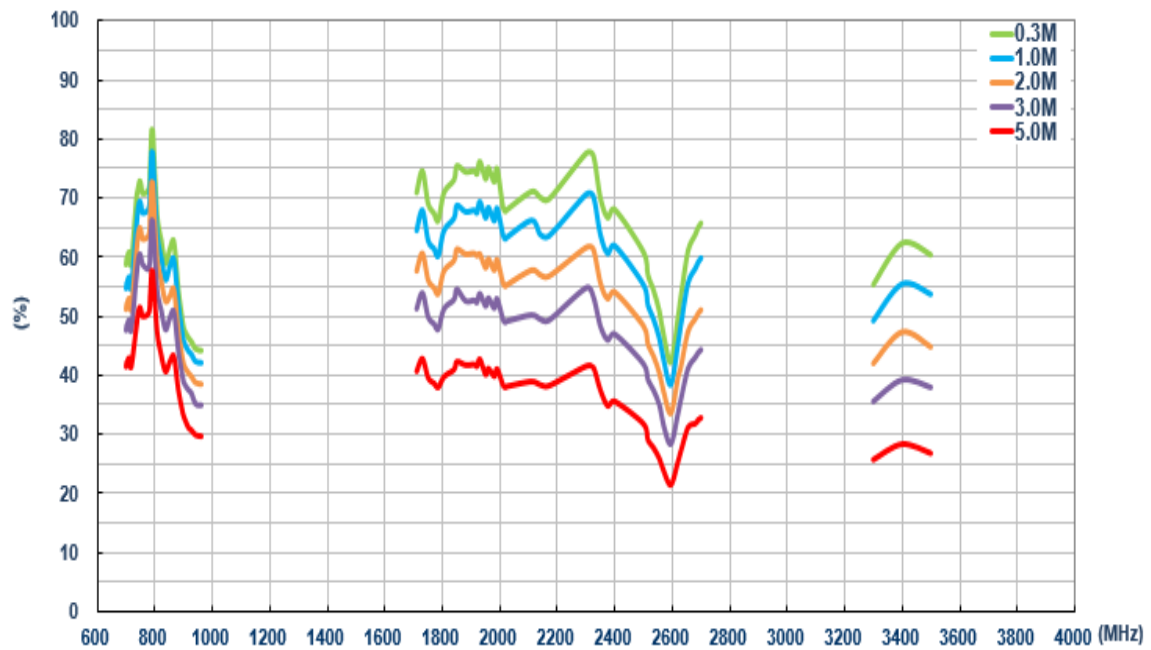

6.5.6 Average Gain (LTE MIMO 1)

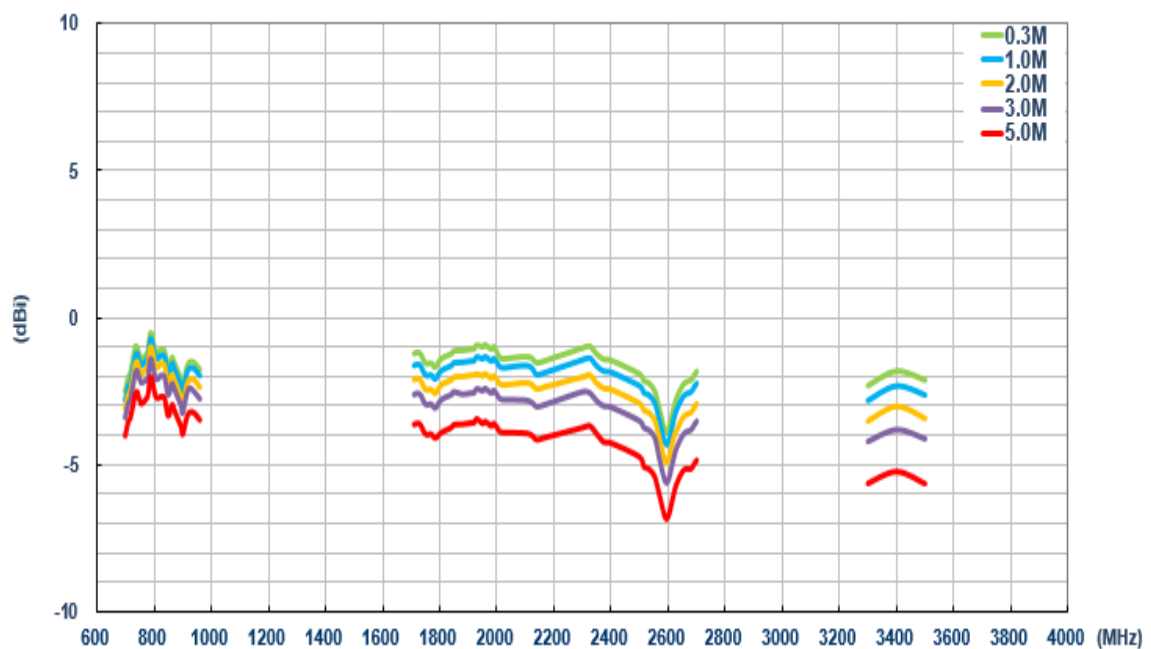

6.5.7 Average Gain (LTE MIMO 2)

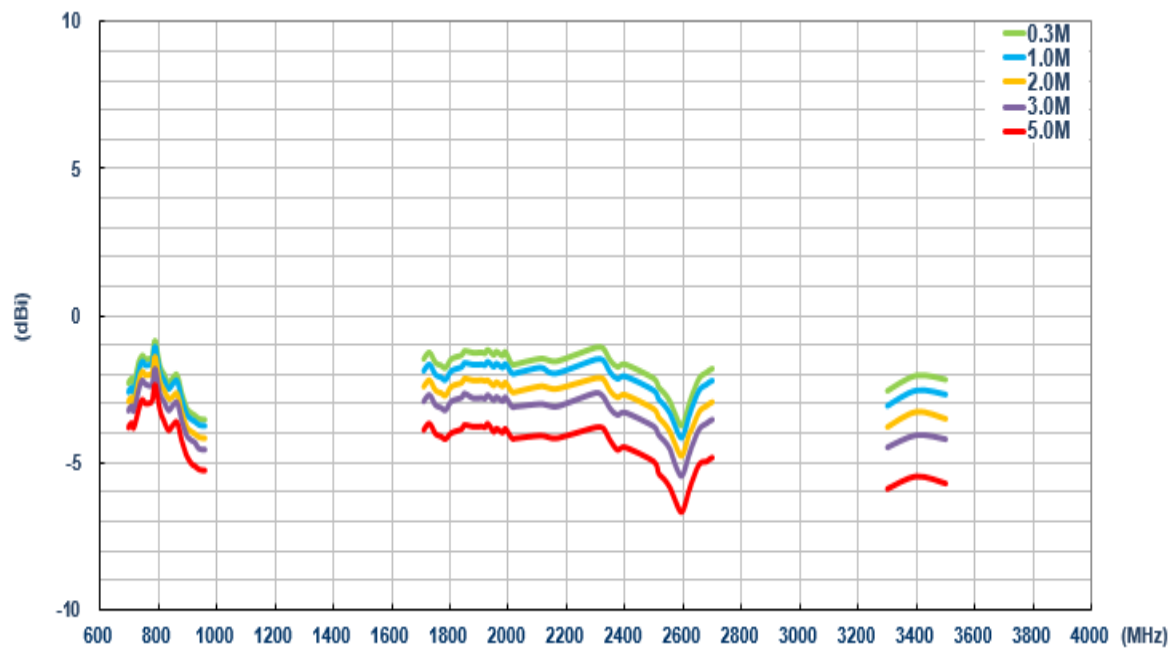

6.5.8 Peak Gain (LTE MIMO 1)

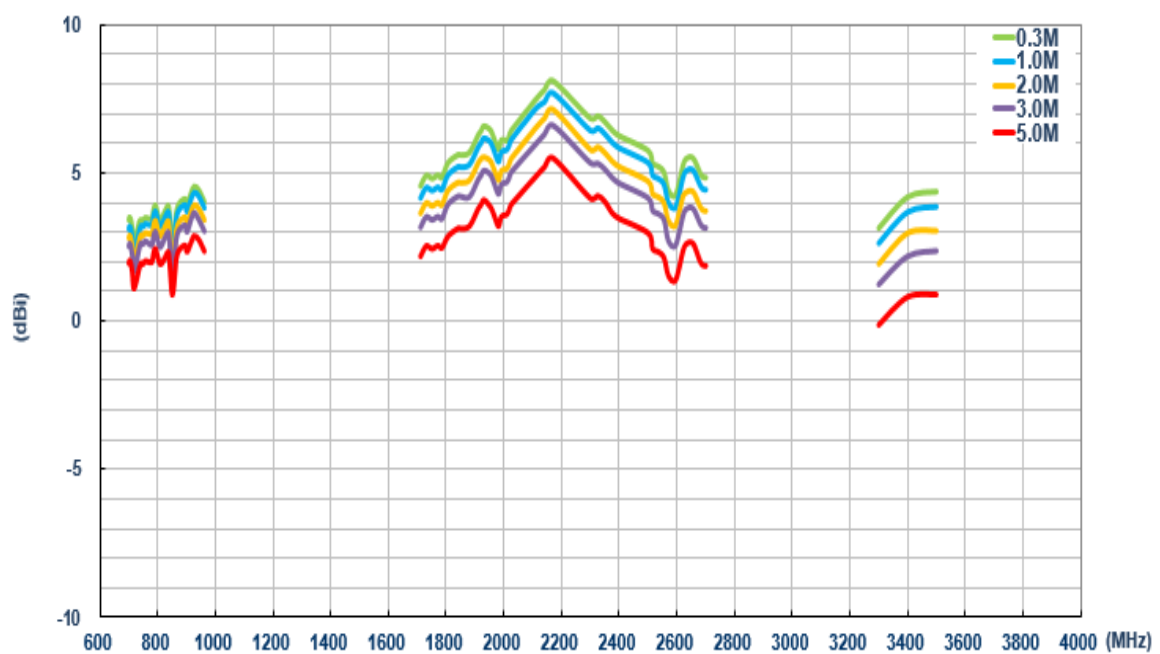

6.5.9 Peak Gain (LTE MIMO 2)

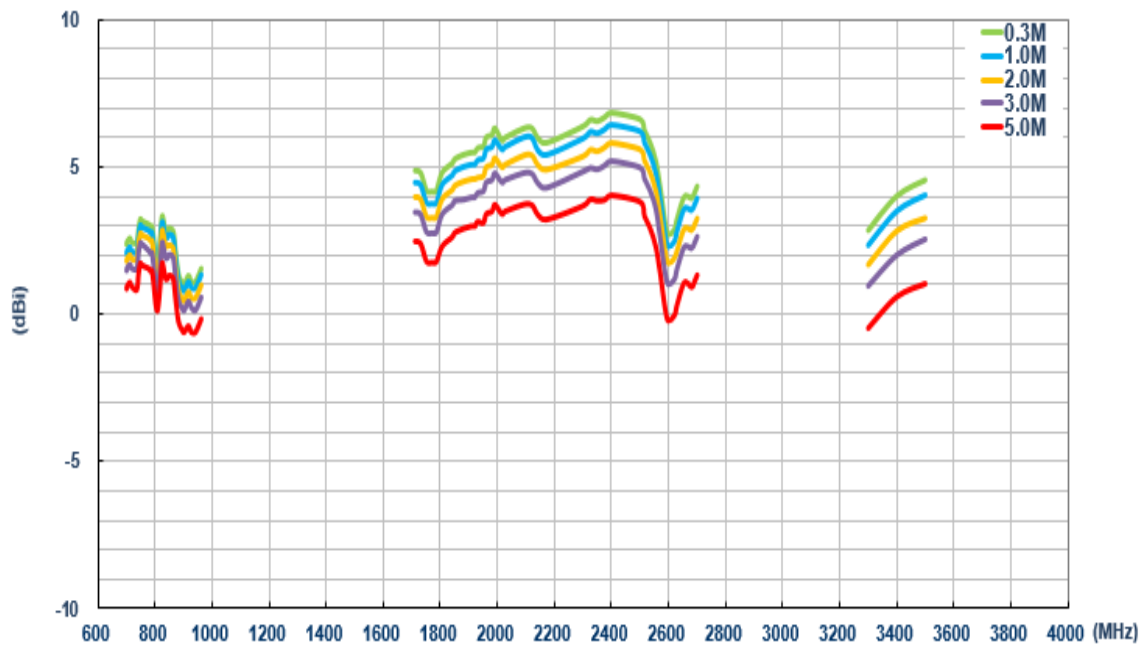

6.6. On glass (Wi-Fi)

6.6.1 Return Loss (Wi-Fi MIMO 1)

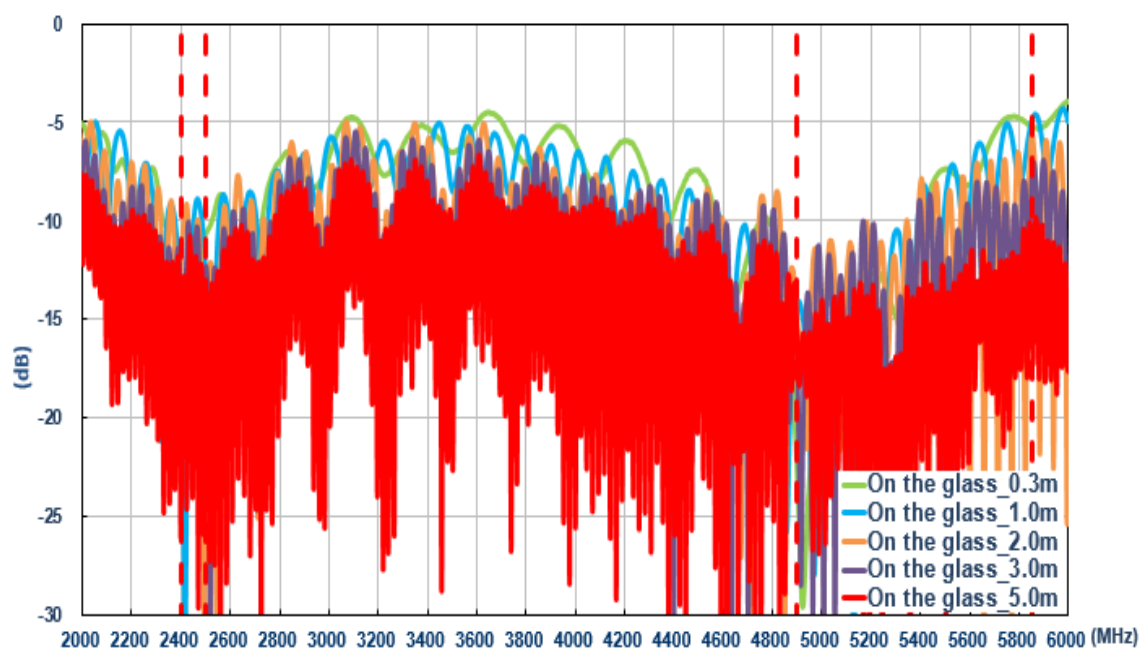

6.6.2 Return Loss (Wi-Fi MIMO 2)

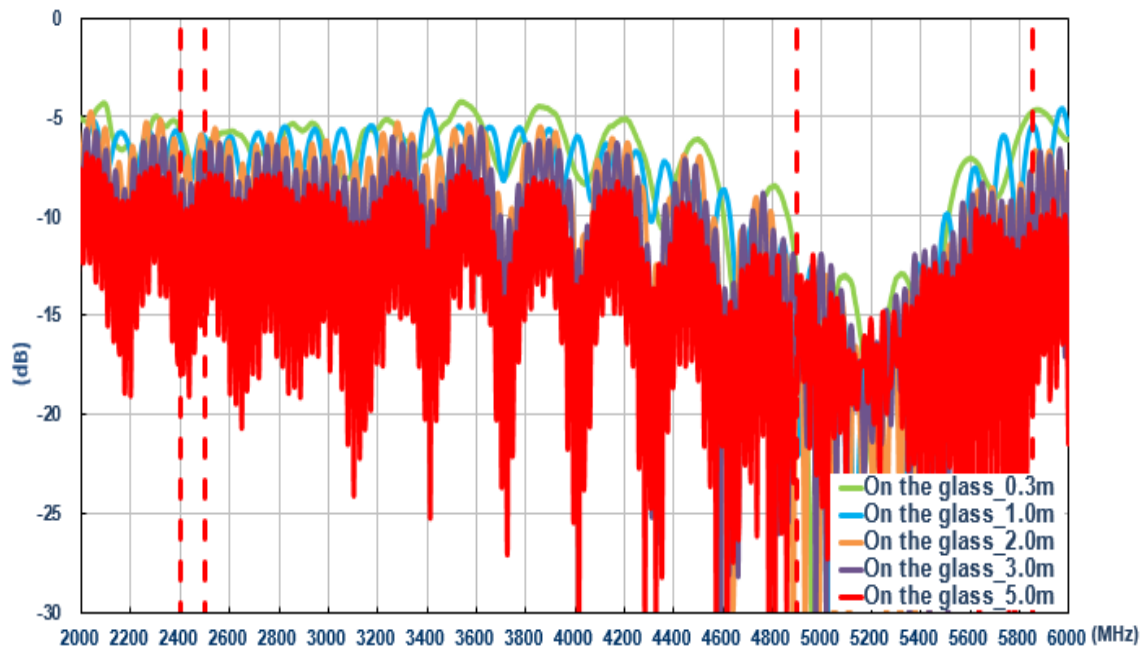

6.6.3 Isolation (Wi-Fi)

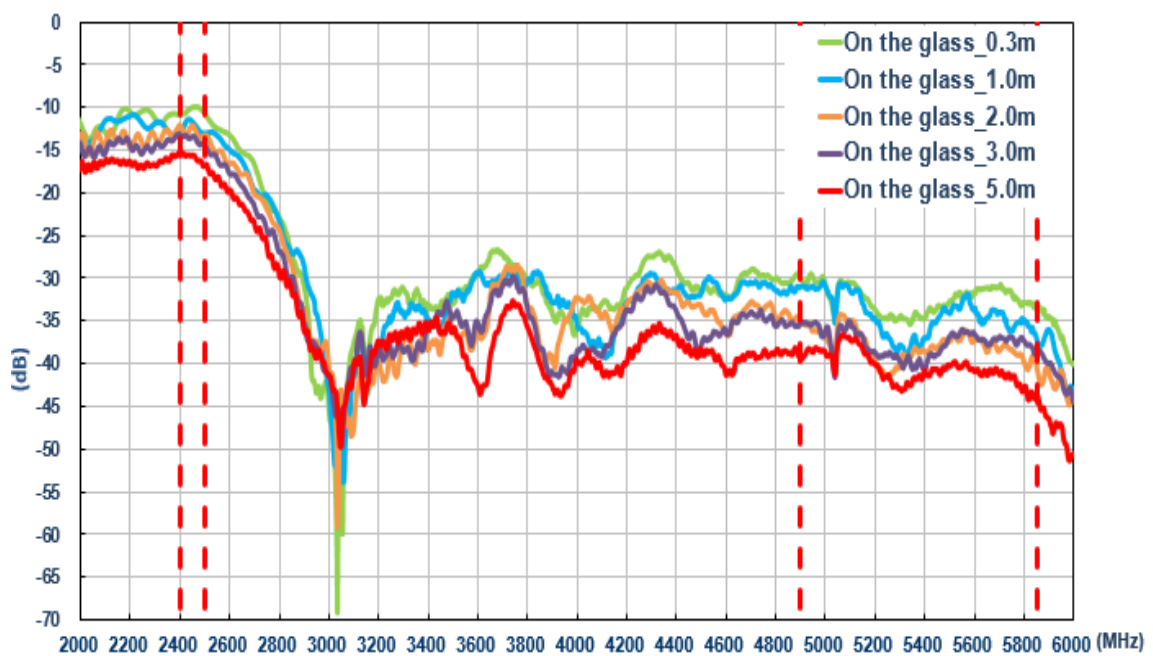

6.6.4 Efficiency (Wi-Fi MIMO 1)

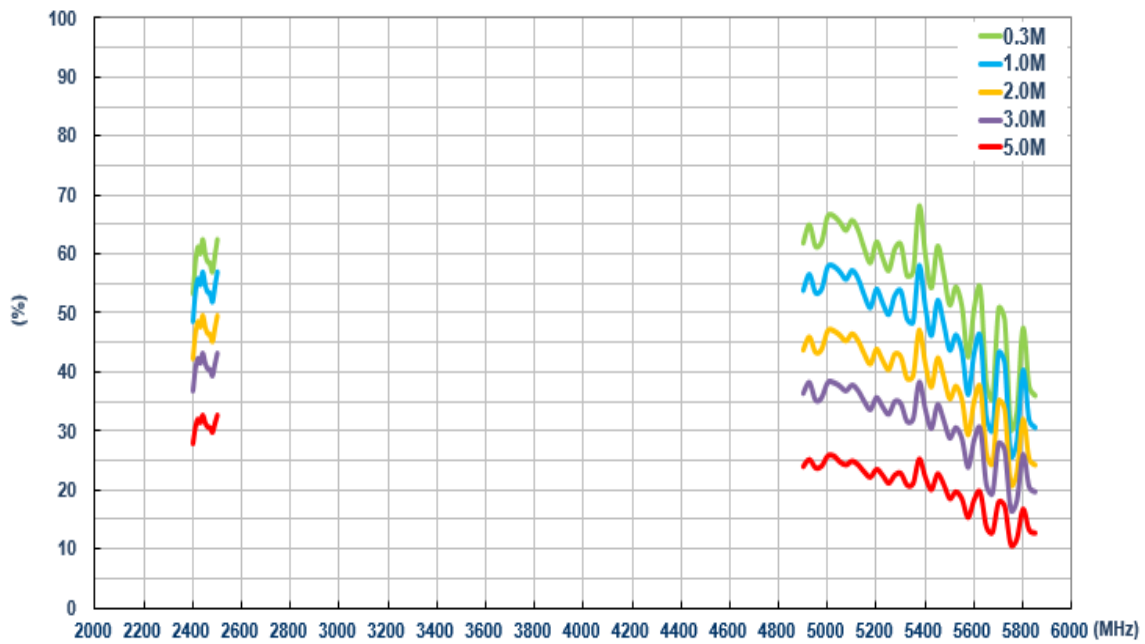

6.6.5 Efficiency (Wi-Fi MIMO 2)

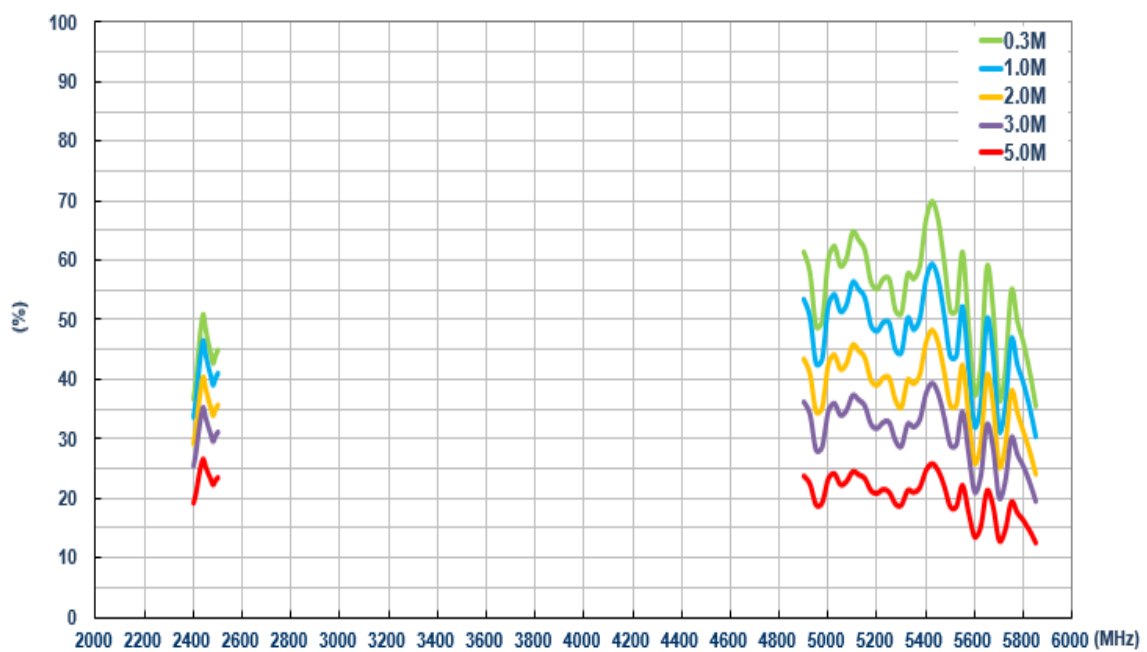

6.6.6 Average Gain (Wi-Fi MIMO 1)

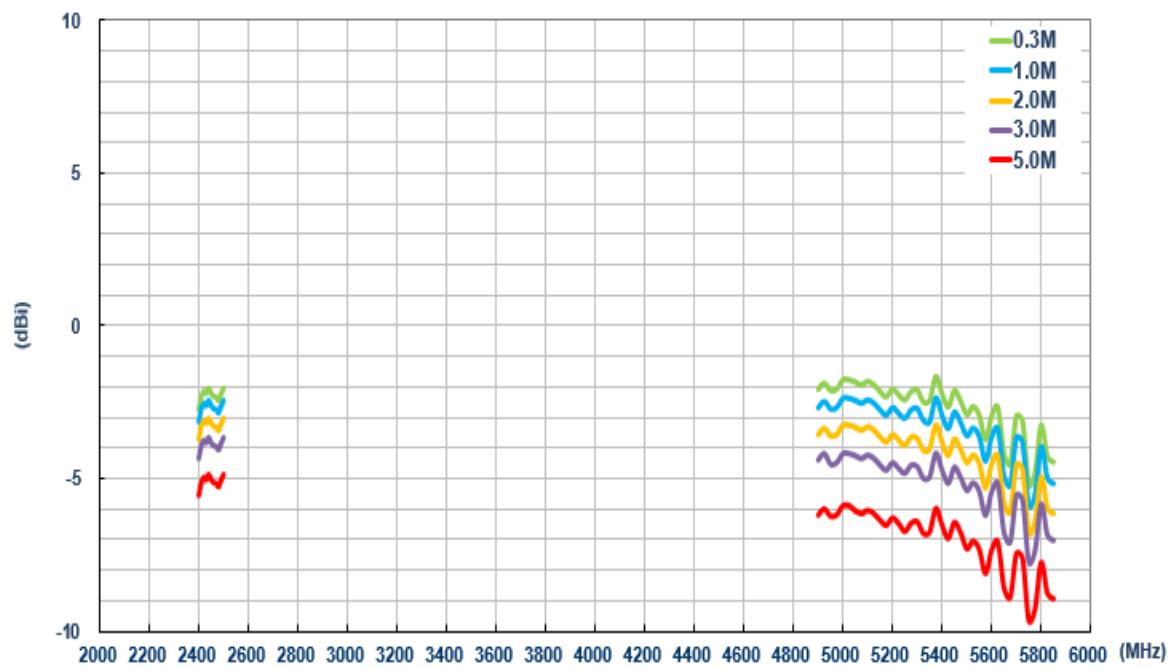

6.6.7 Average Gain (Wi-Fi MIMO 2)

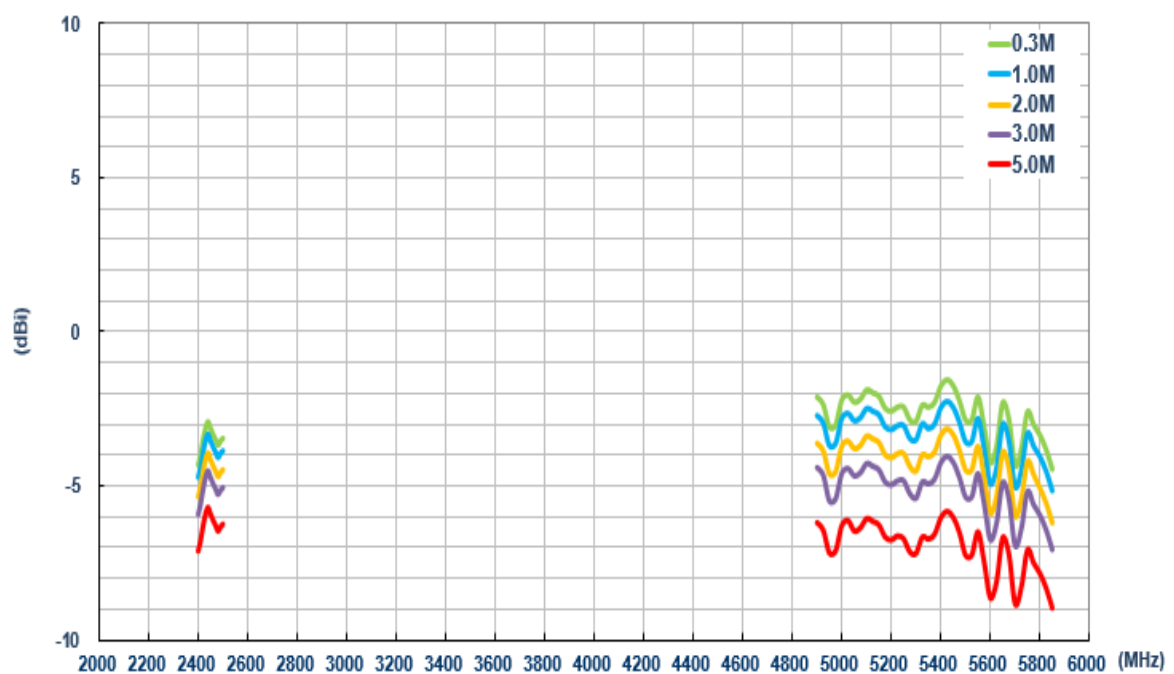

6.6.8 Peak Gain (Wi-Fi MIMO 1)

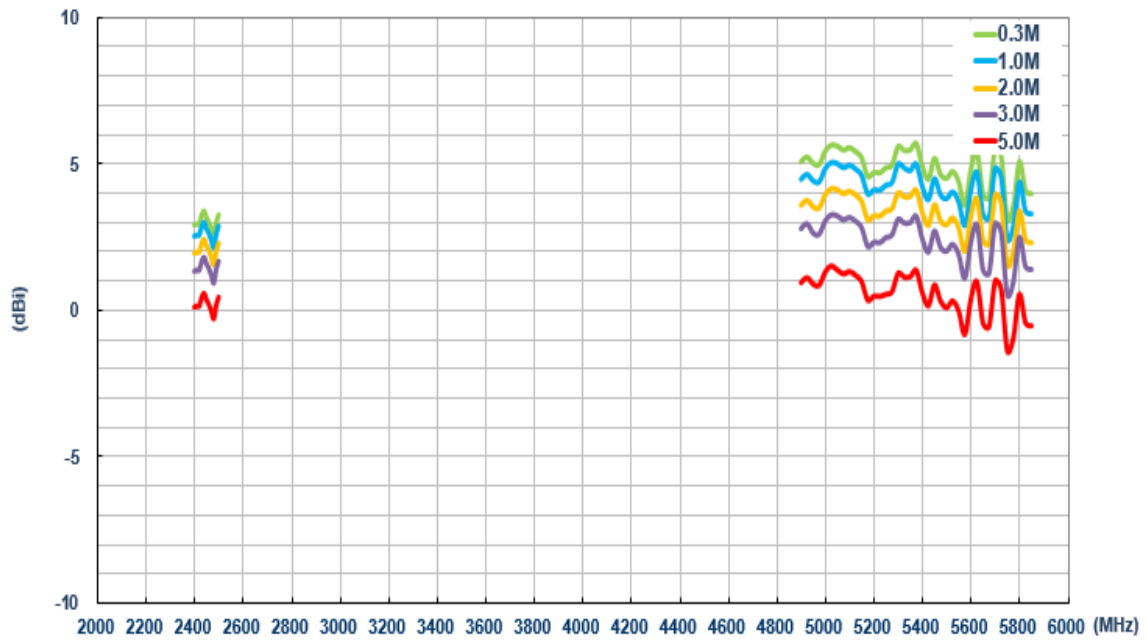

6.6.9 Peak Gain (Wi-Fi MIMO 2)

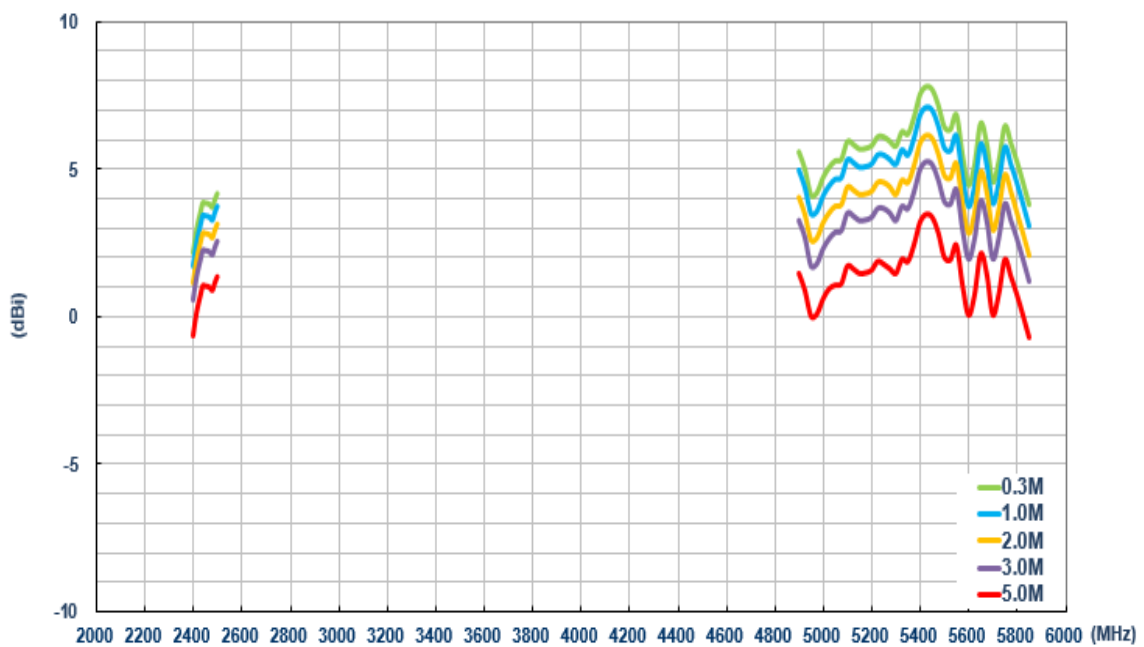

6.7. On metal (LTE)

6.7.1 Return Loss (LTE MIMO 1)

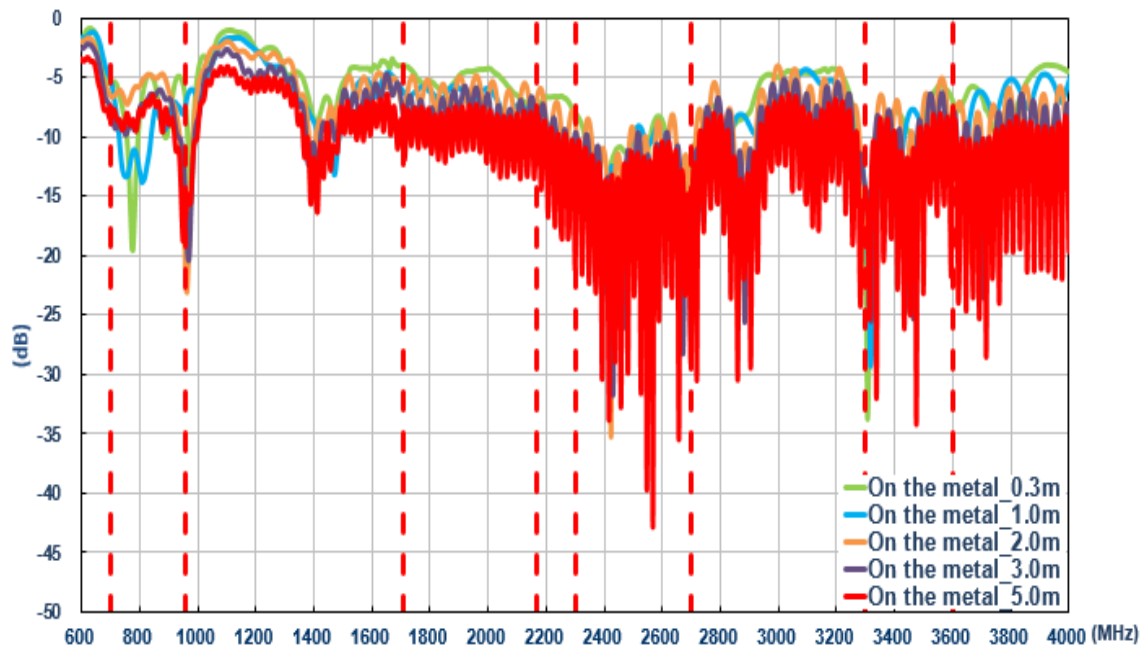

6.7.2 Return Loss (LTE MIMO 2)

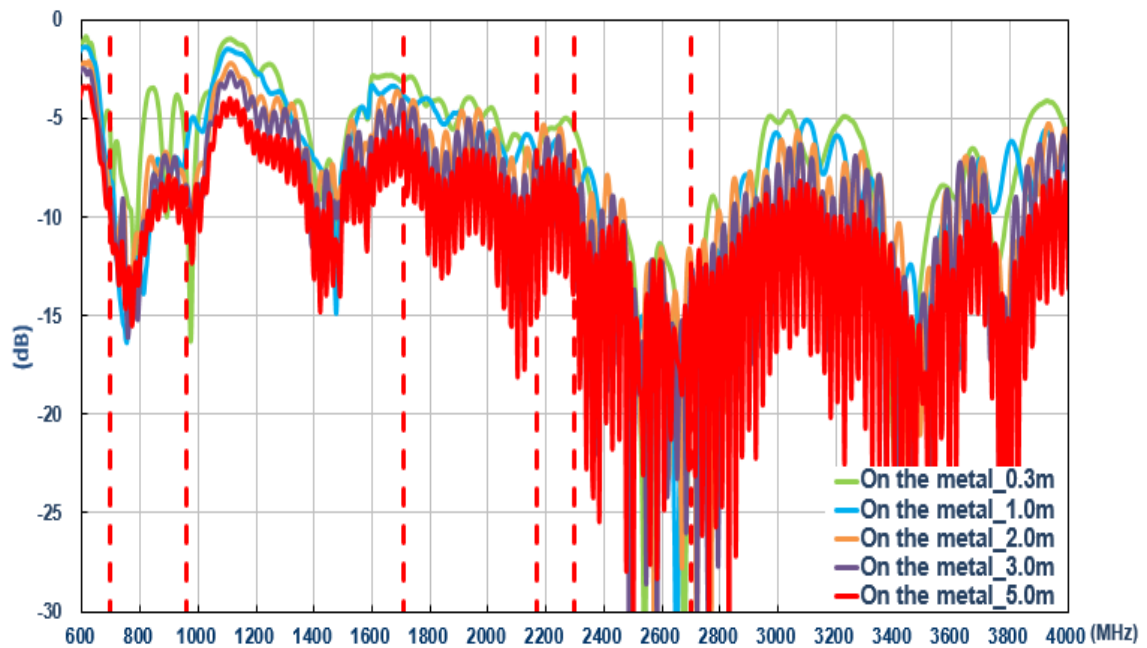

6.7.3 Isolation (LTE antenna)

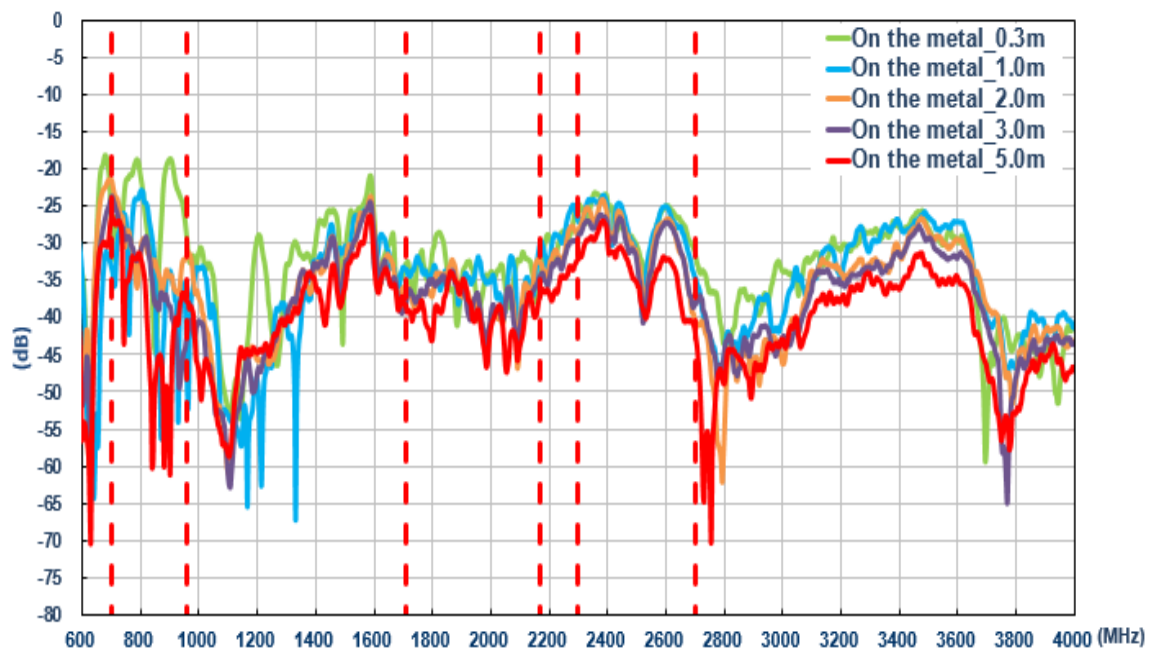

6.7.4 Efficiency (LTE MIMO 1)

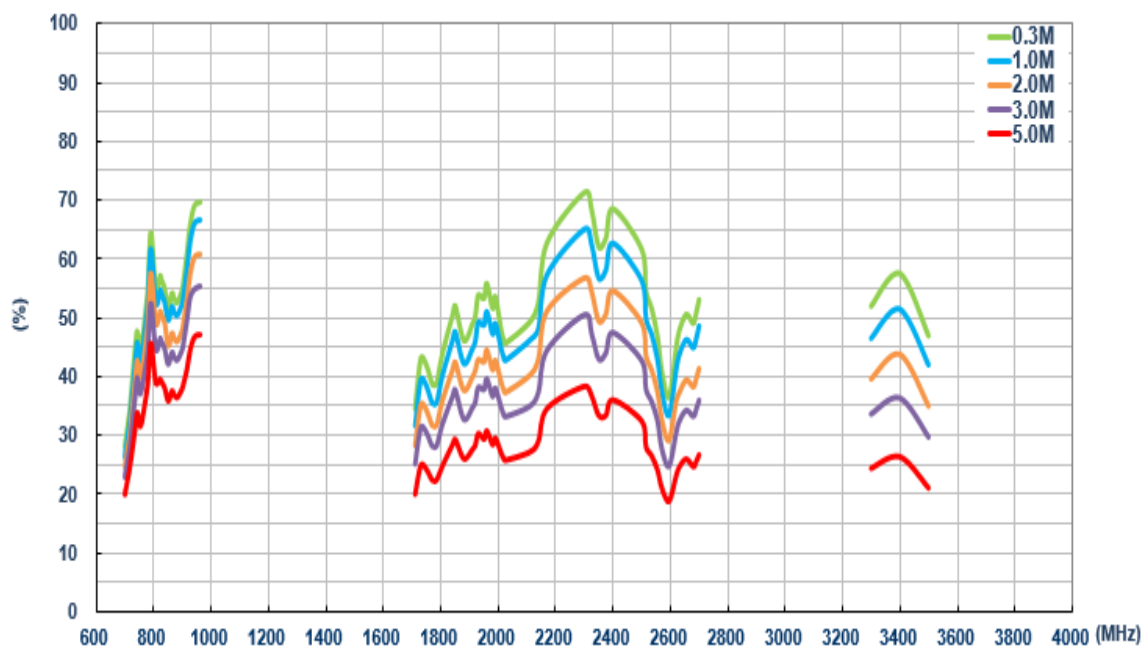

6.7.5 Efficiency (LTE MIMO 2)

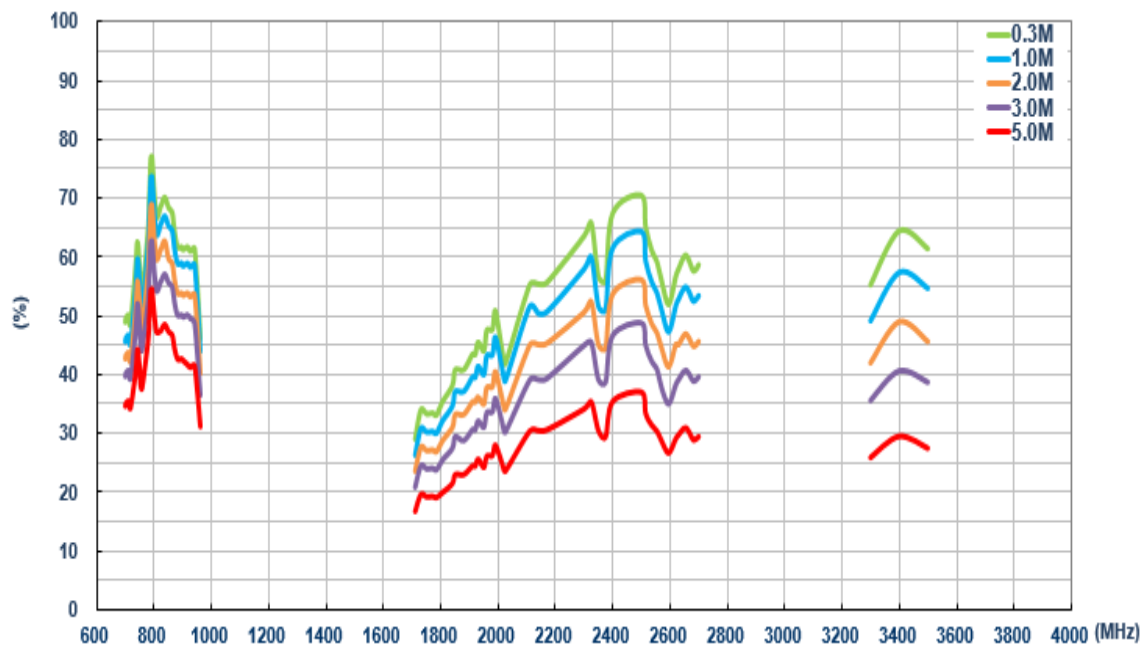

6.7.6 Average Gain (LTE MIMO 1)

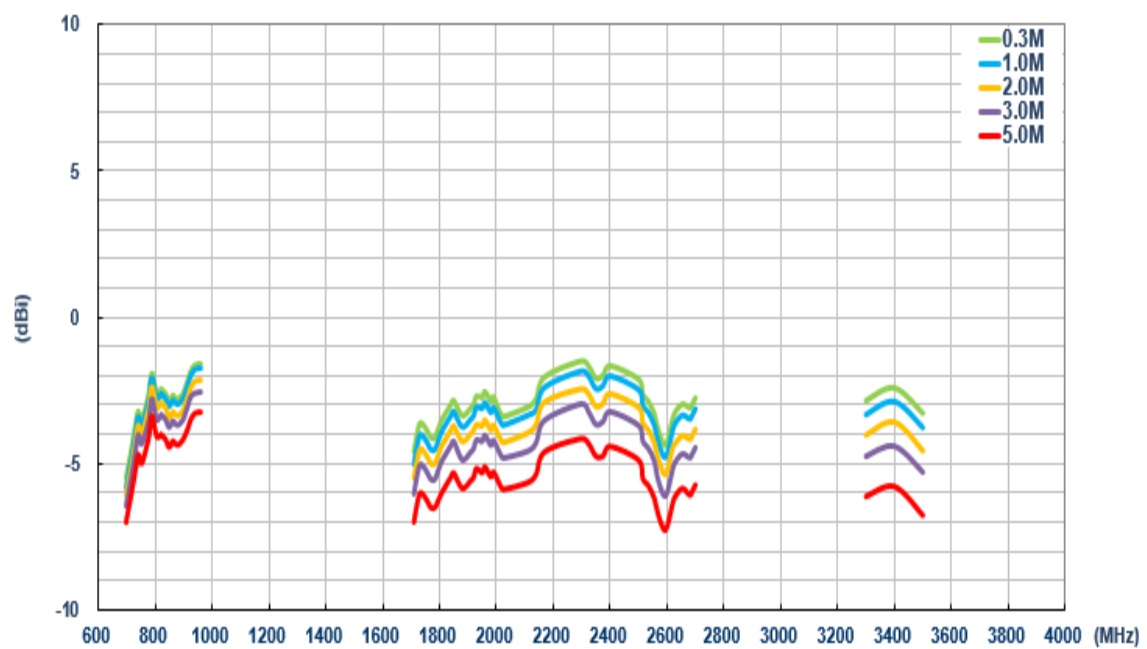

6.7.7 Average Gain (LTE MIMO 2)

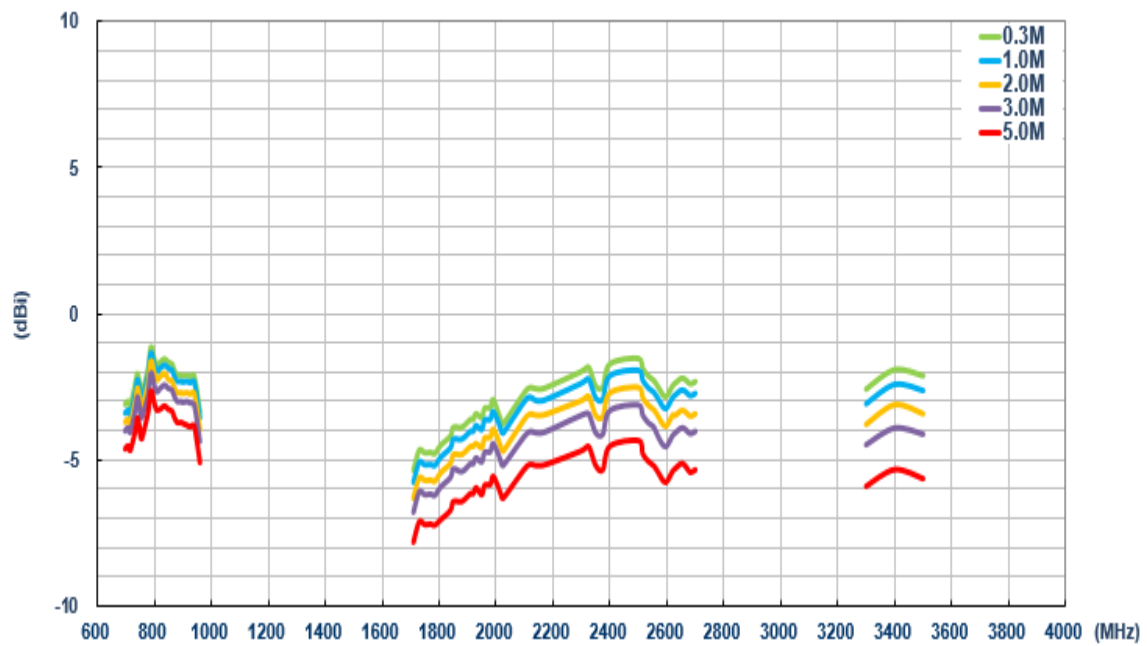

6.7.8 Peak Gain (LTE MIMO 1)

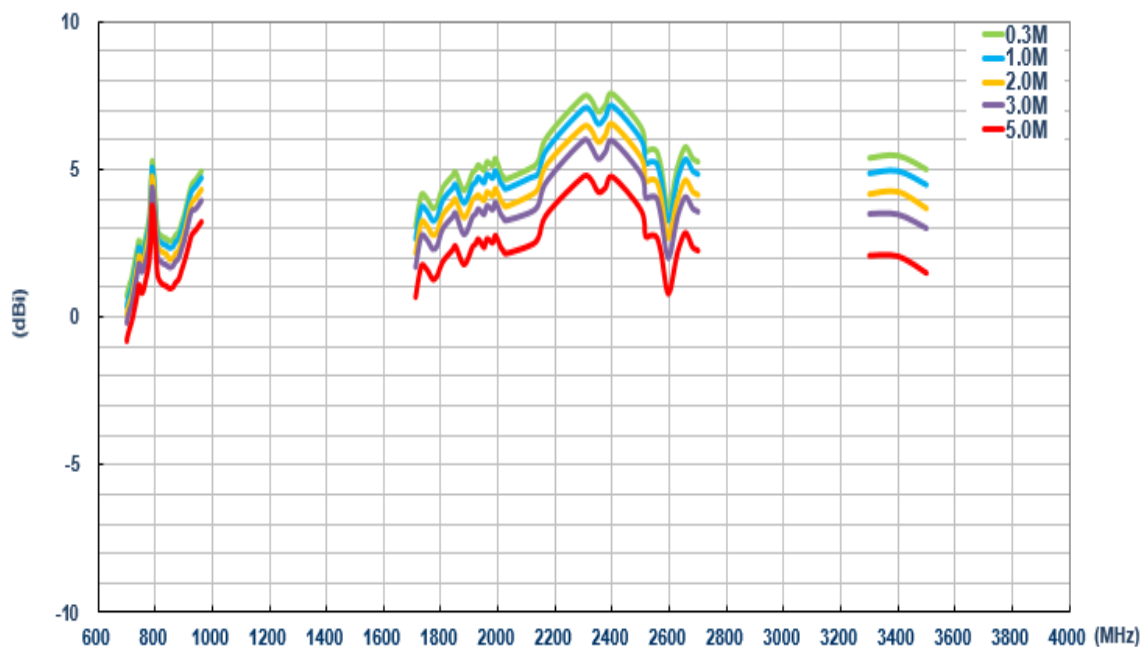

6.7.9 Peak Gain (LTE MIMO 2)

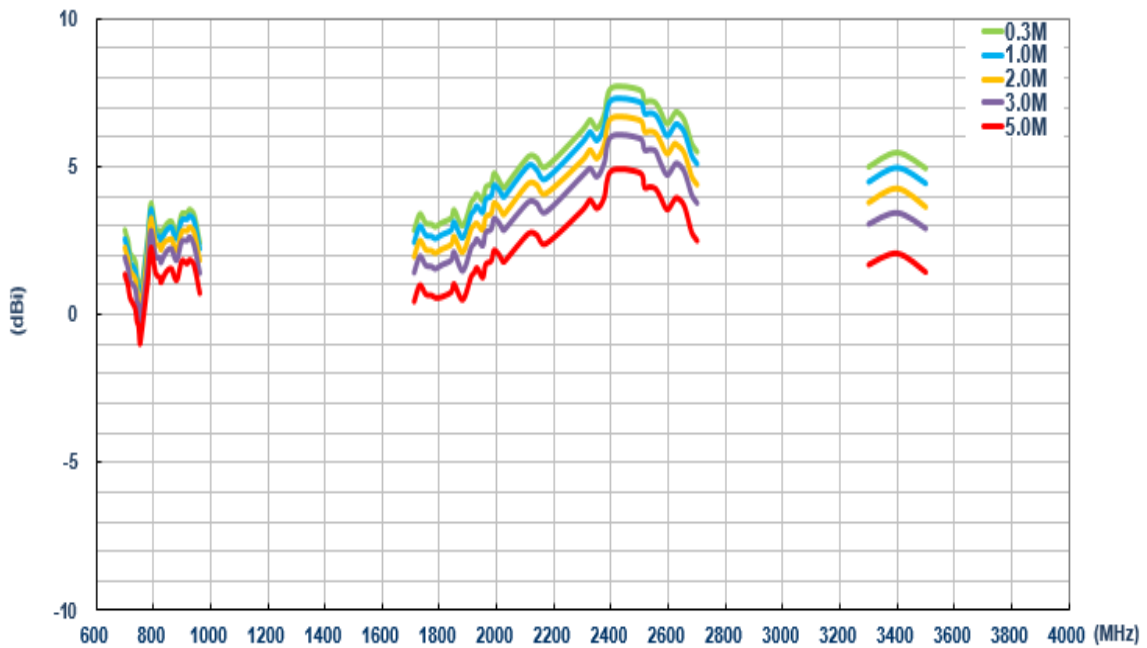

6.8. On metal (Wi-Fi)

6.8.1 Return Loss (Wi-Fi MIMO 1)

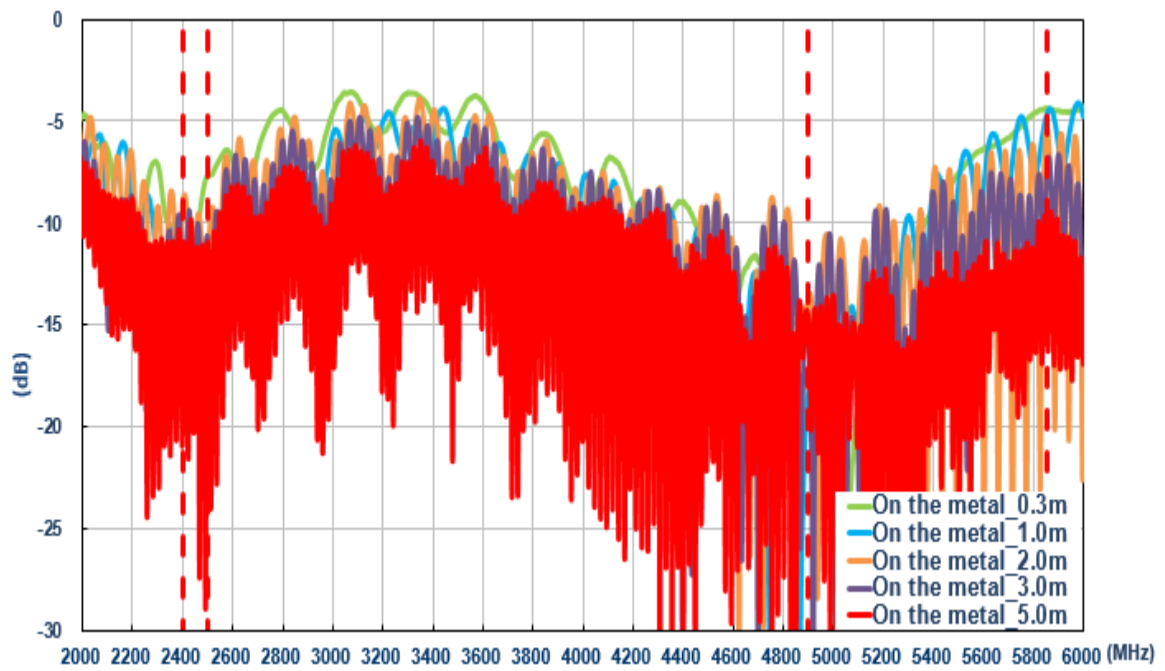

6.8.2 Return Loss (LTE MIMO 1)

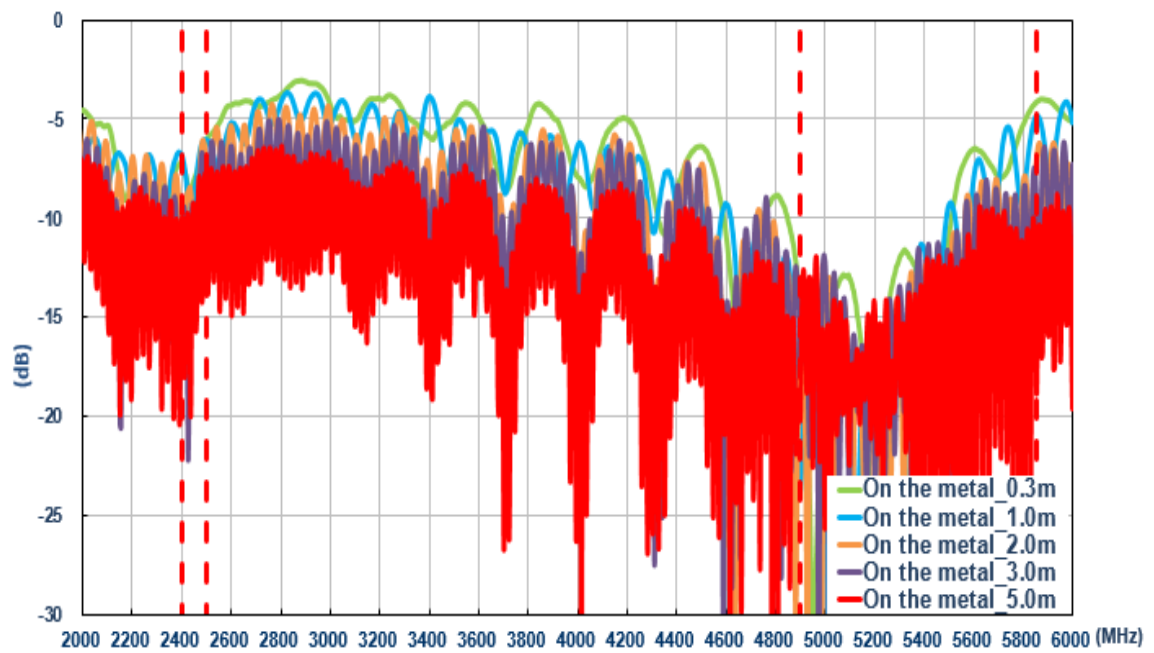

6.8.3 Isolation (Wi-Fi)

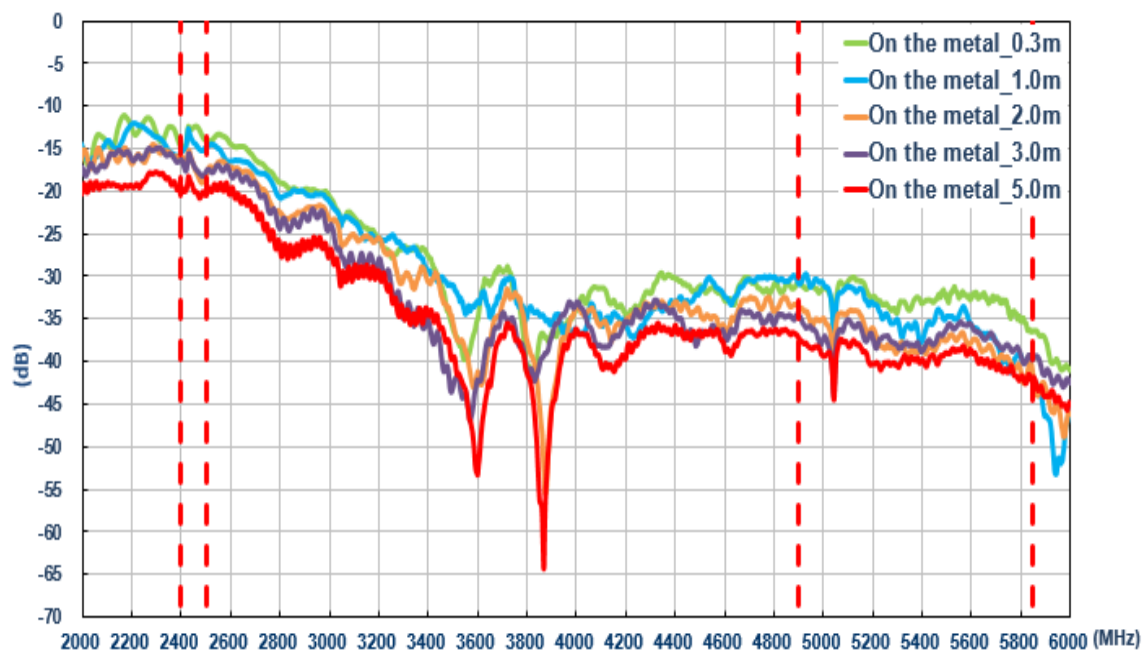

6.8.4 Efficiency (Wi-Fi MIMO 1)

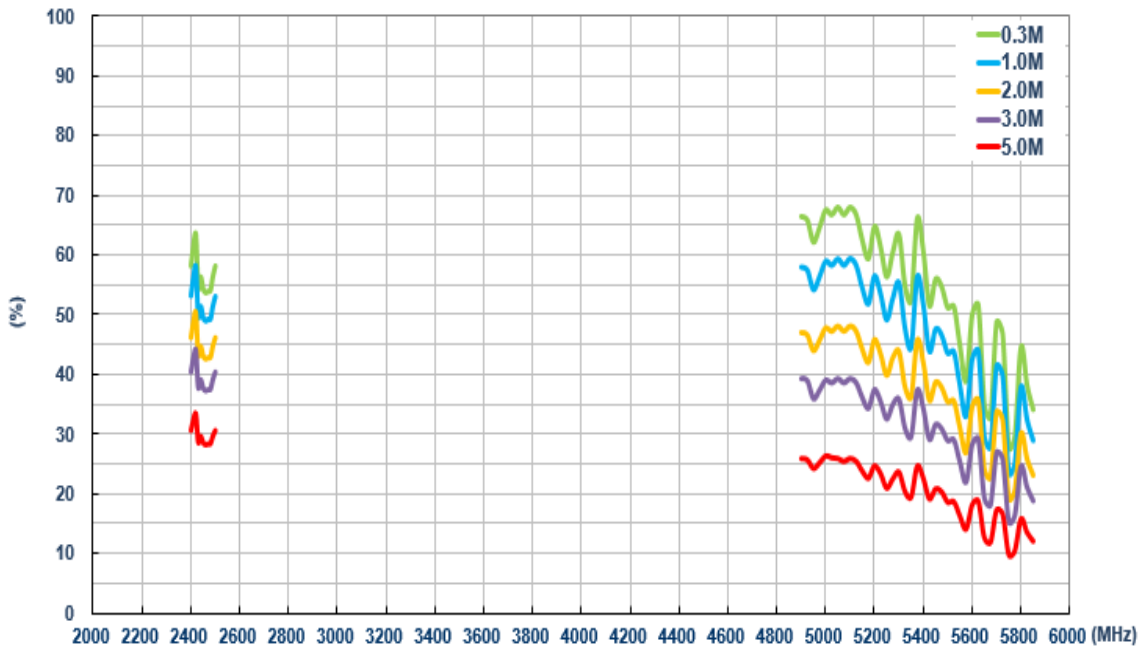

6.8.5 Efficiency (Wi-Fi MIMO 2)

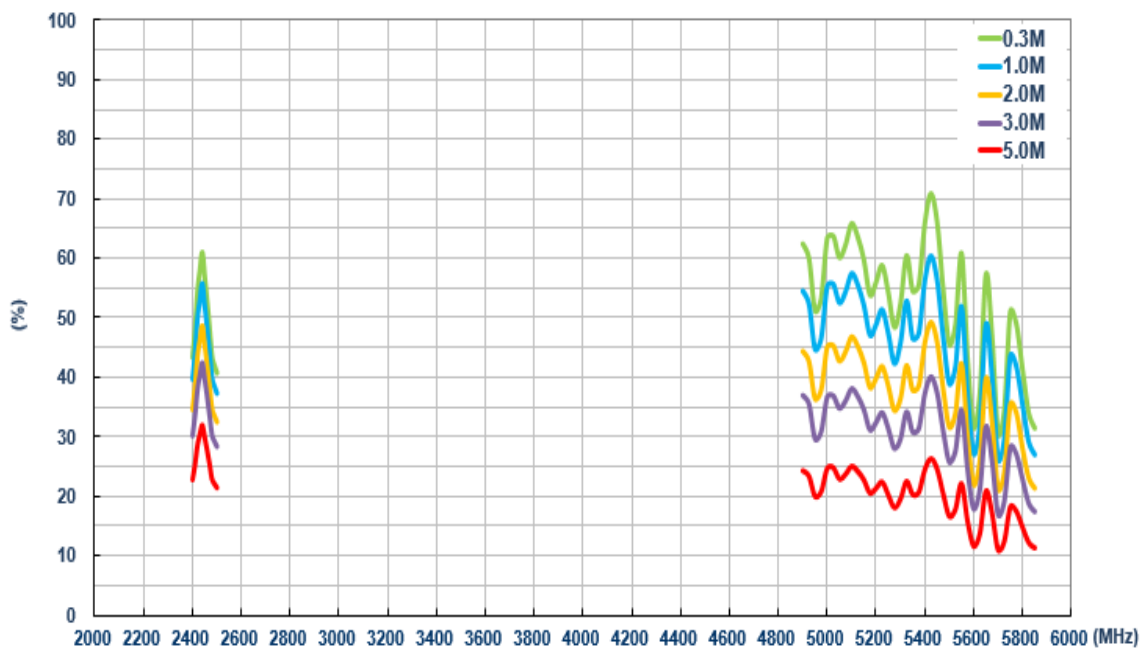

6.8.6 Average Gain (Wi-Fi MIMO 1)

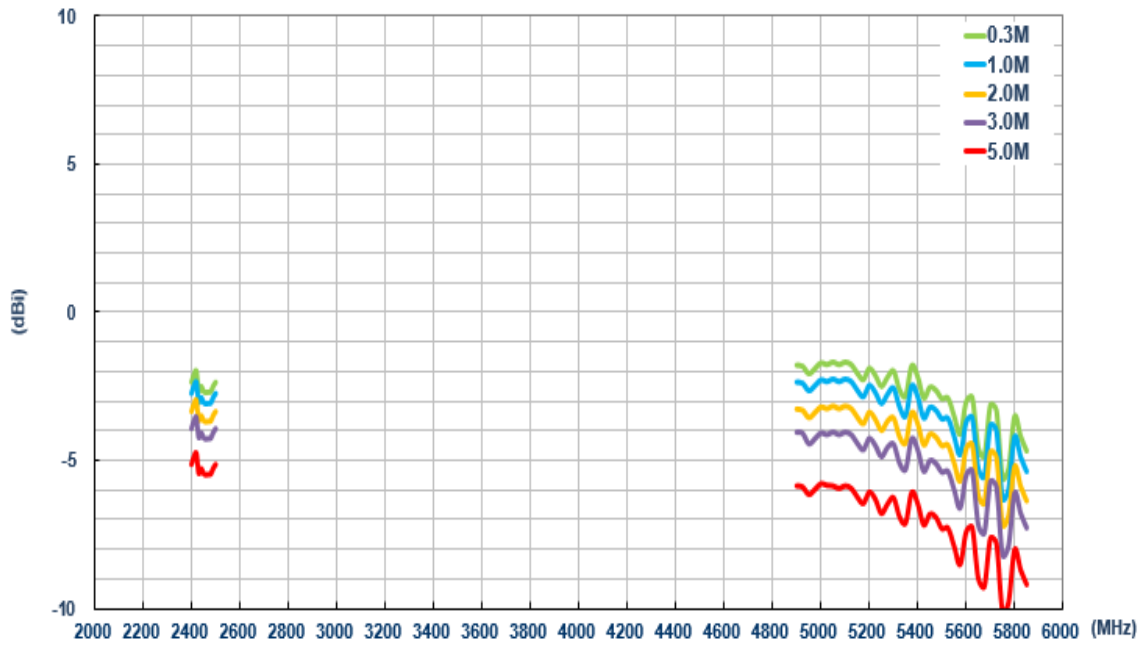

6.8.7 Average Gain (Wi-Fi MIMO 2)

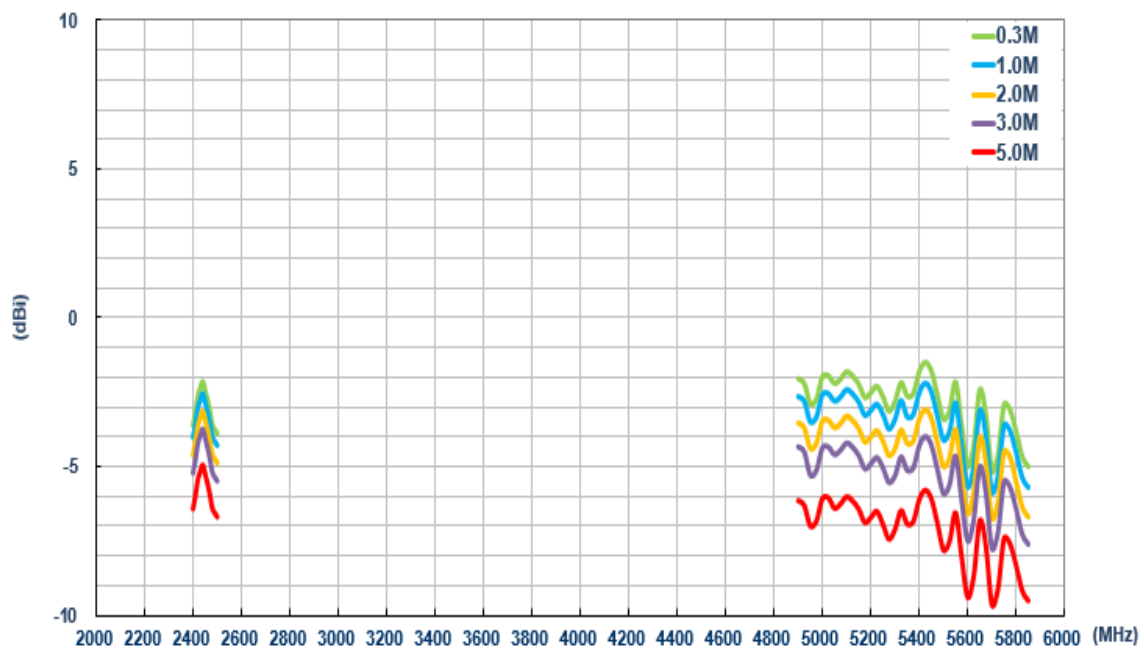

6.8.8 Peak Gain (Wi-Fi MIMO 1)

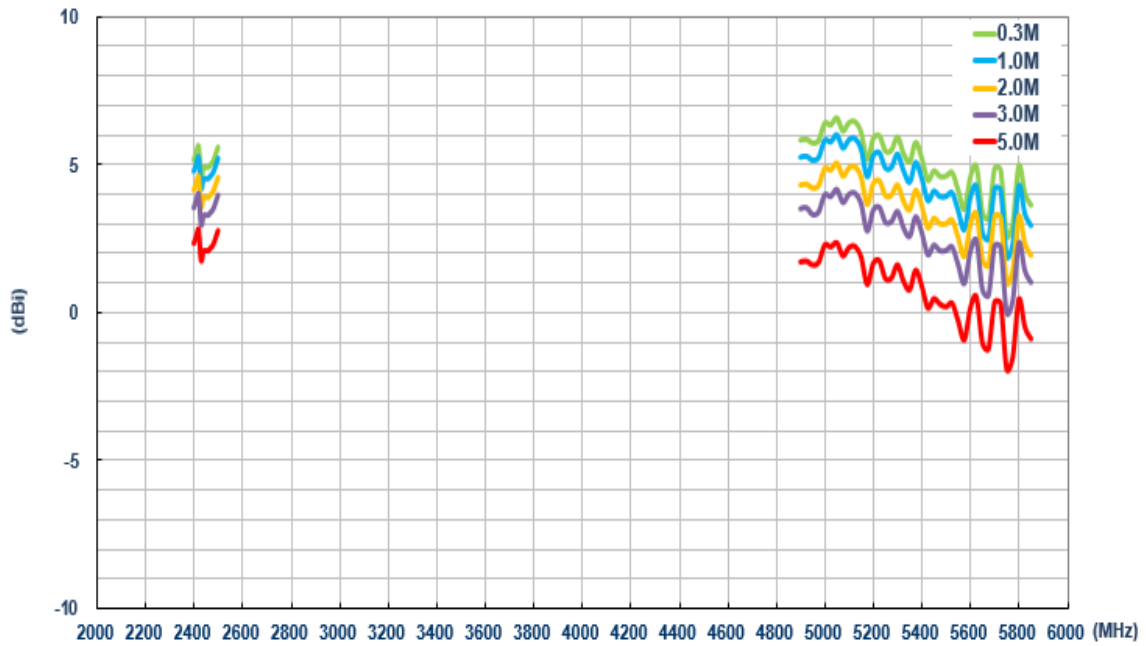

6.8.9 Peak Gain (Wi-Fi MIMO 2)

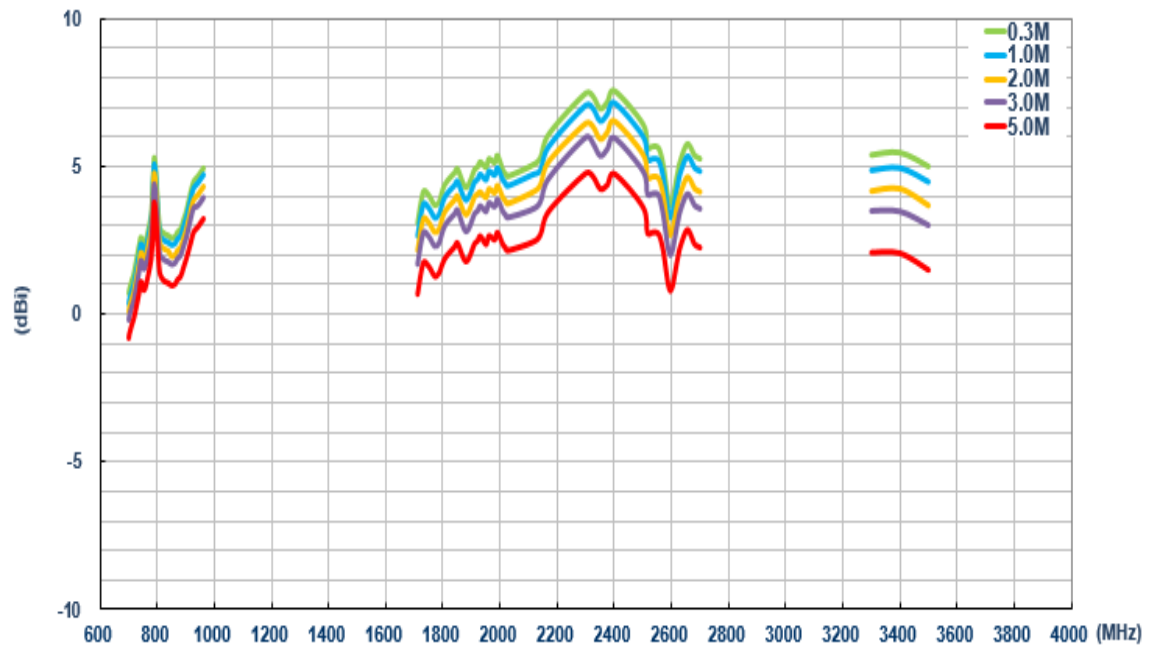

6.9. On the wall (LTE)

6.9.1 Return Loss (LTE MIMO 1)

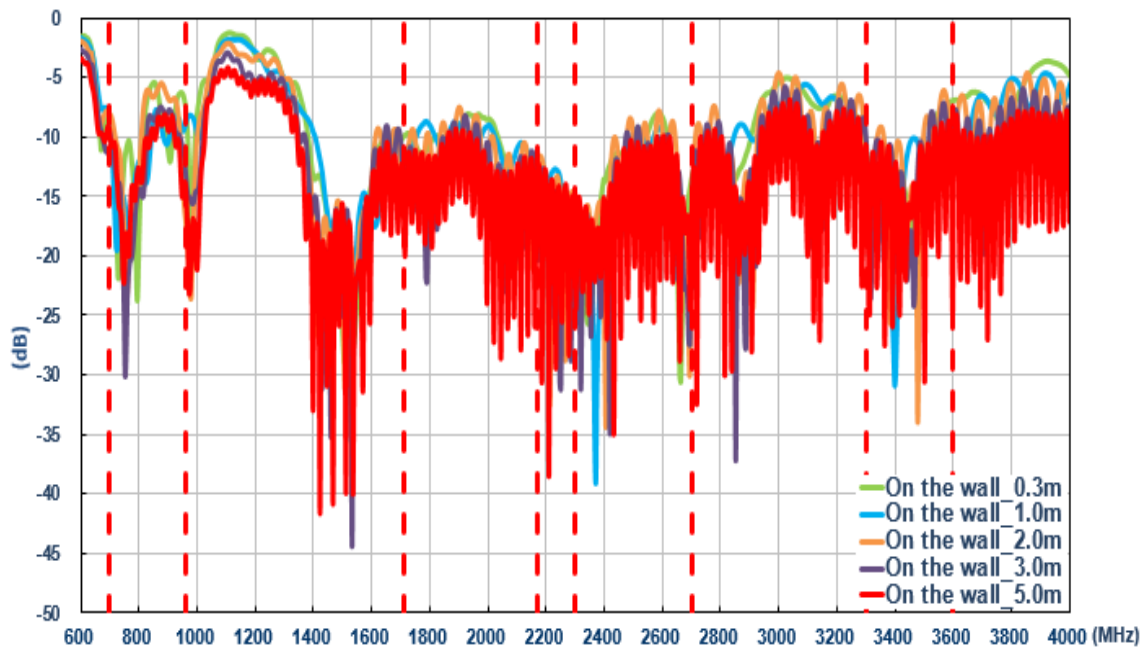

6.9.2 Return Loss (LTE MIMO 2)

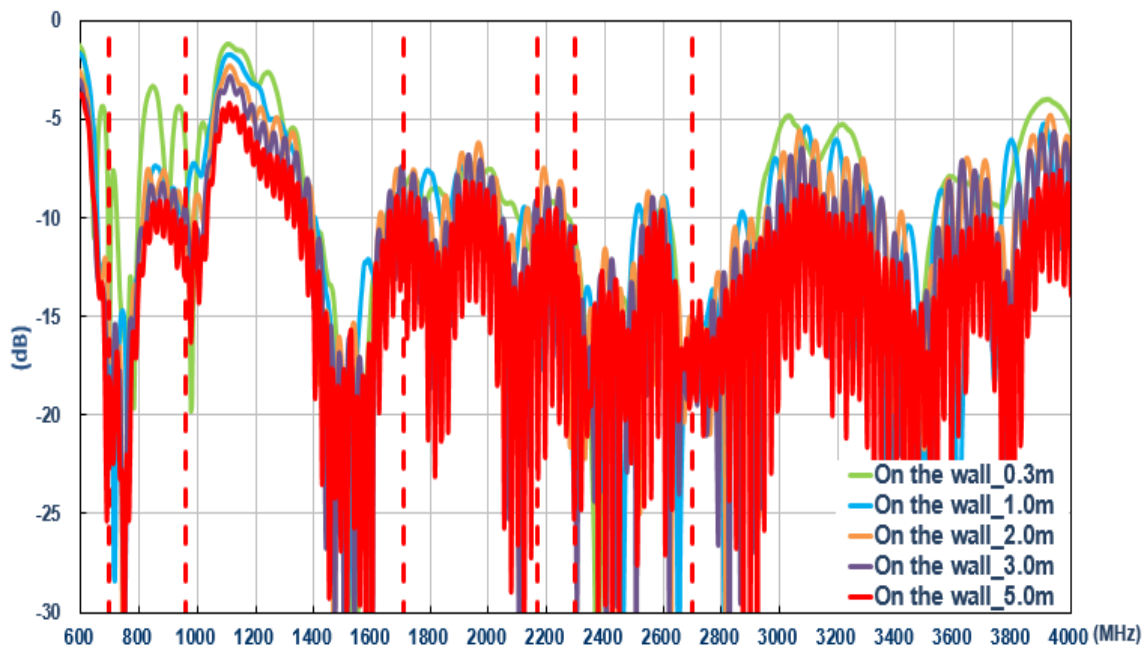

6.9.3 Isolation (LTE Antenna)

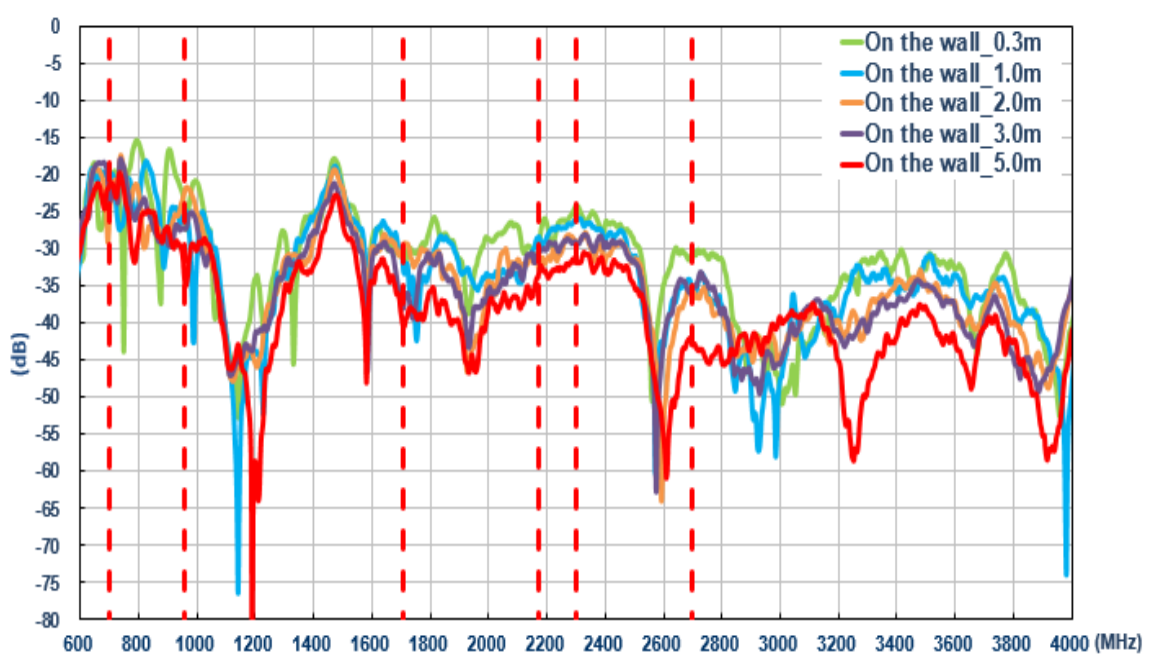

6.9.4 Efficiency (LTE MIMO 1)

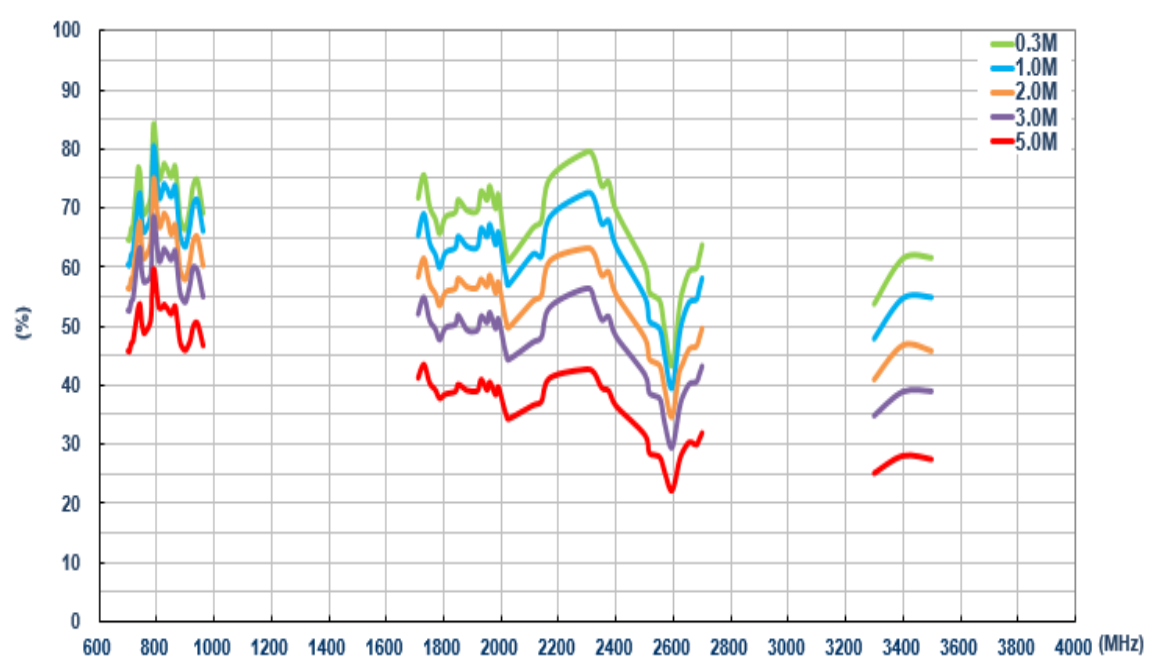

6.9.5 Efficiency (LTE MIMO 2)

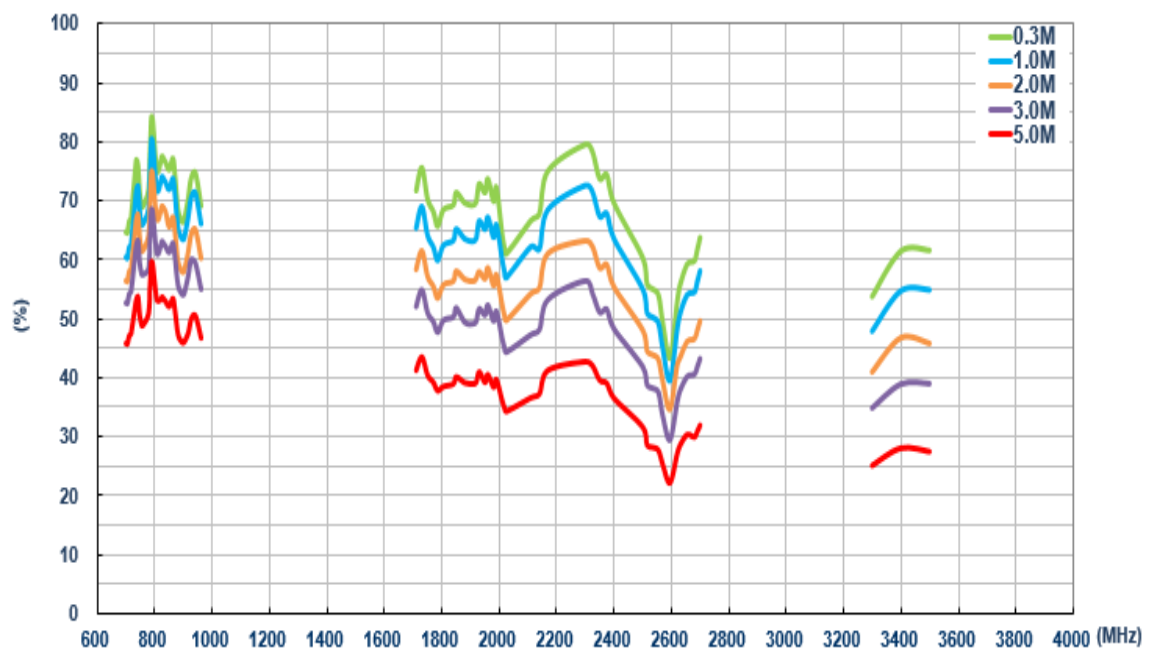

6.9.6 Average Gain (LTE MIMO 1)

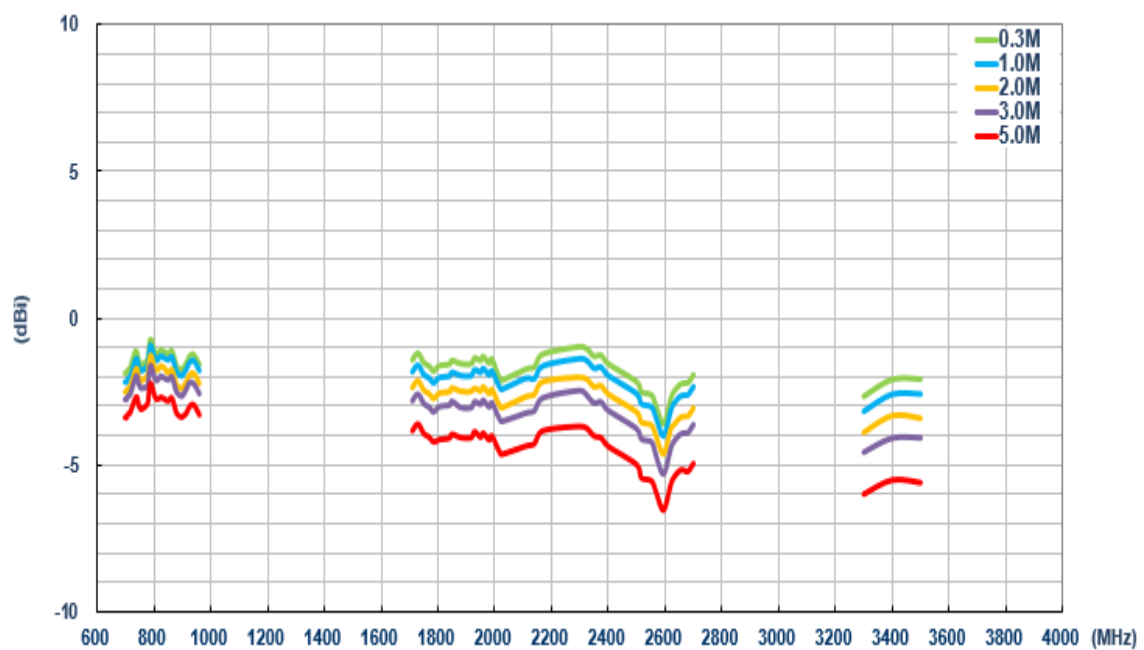

6.9.7 Average Gain (LTE MIMO 2)

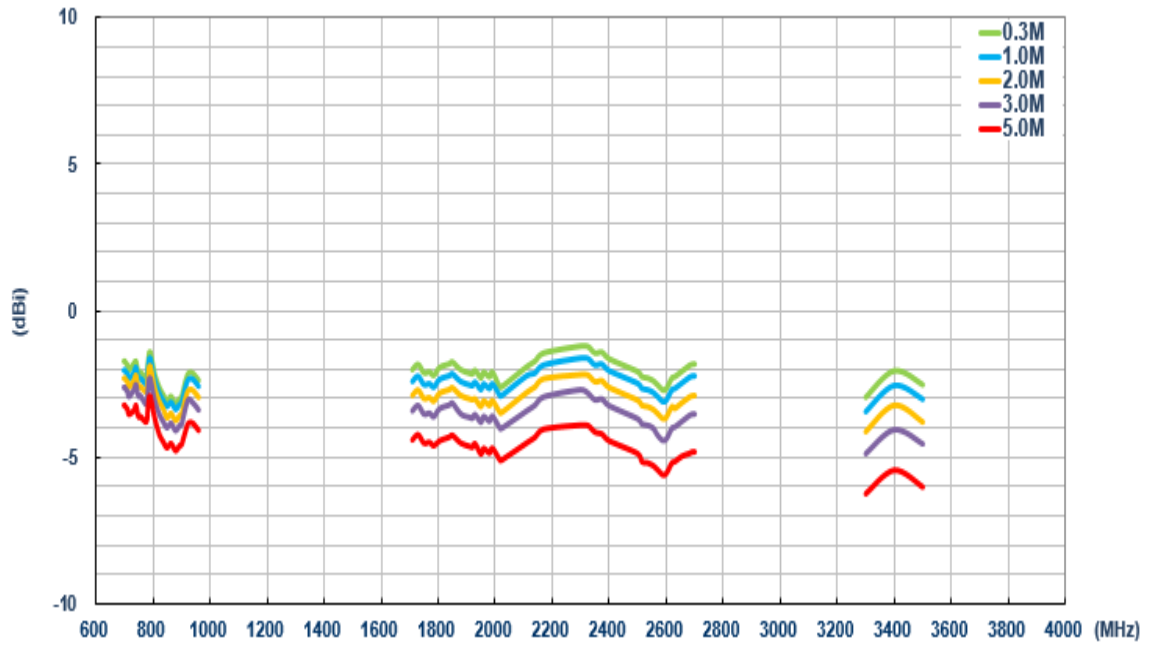

6.9.8 Peak Gain (LTE MIMO 1)

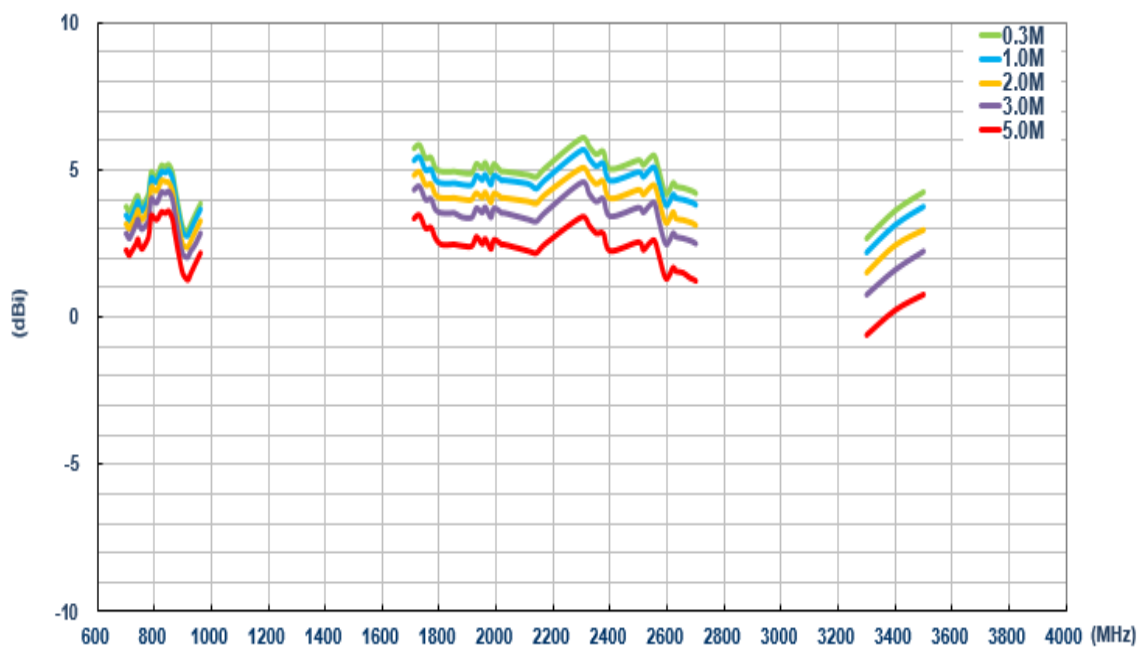

6.9.9 Peak Gain (LTE MIMO 2)

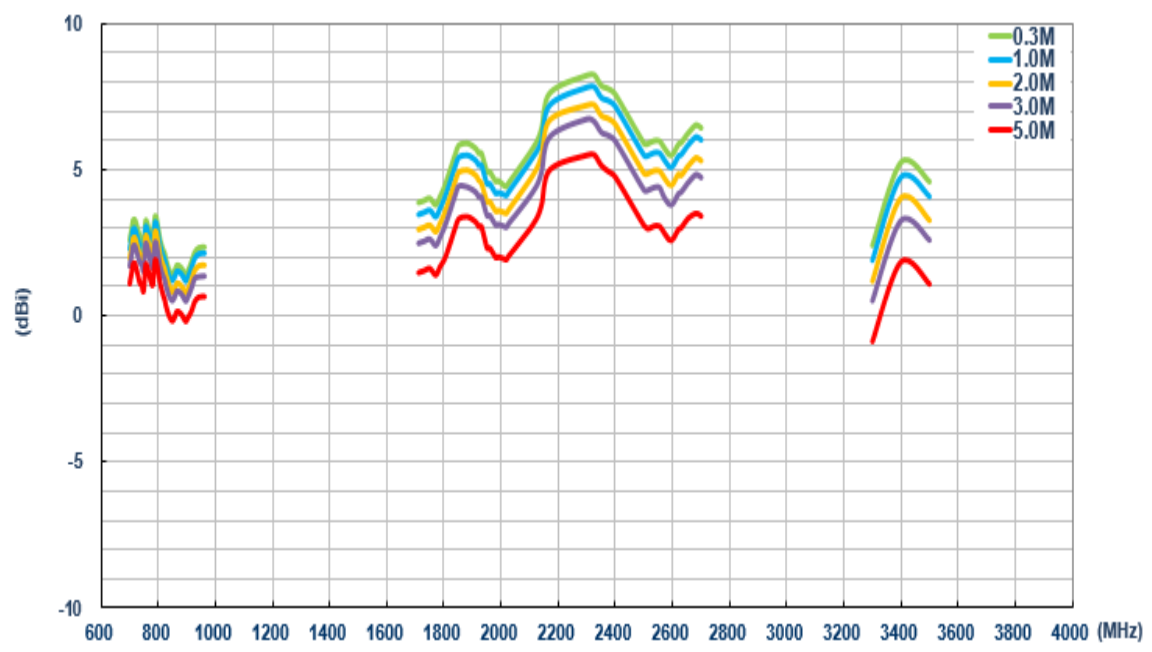

6.9.9 Peak Gain (LTE MIMO 2)

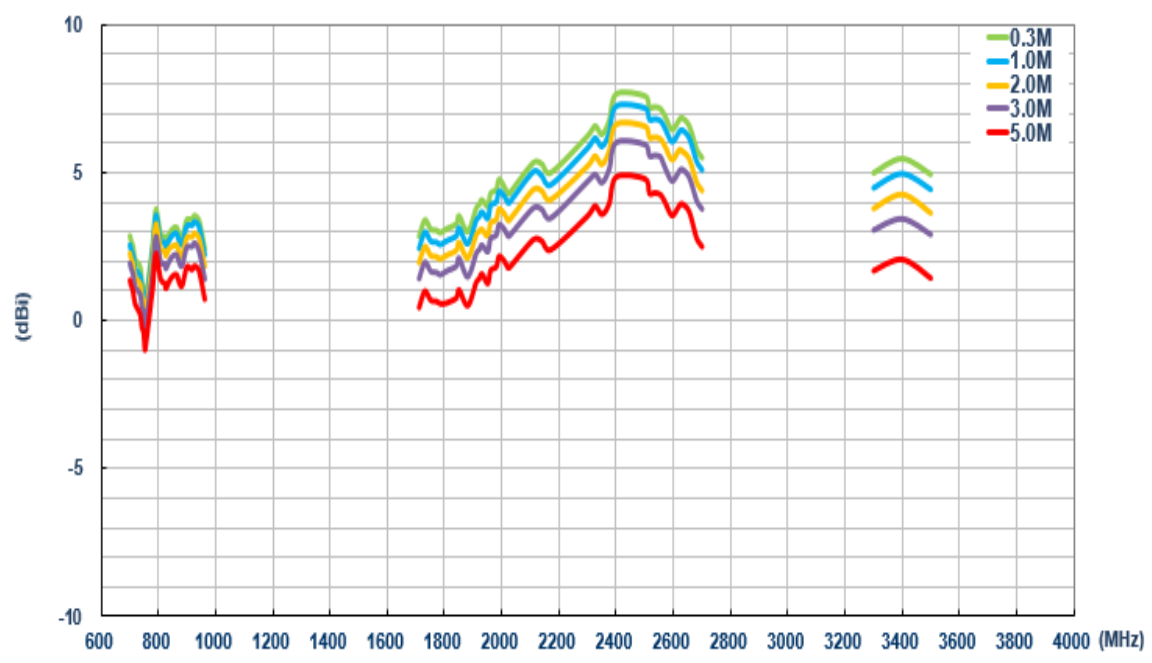

6.10. On wall (Wi-Fi)

6.10.1 Return Loss (Wi-Fi MIMO 1)

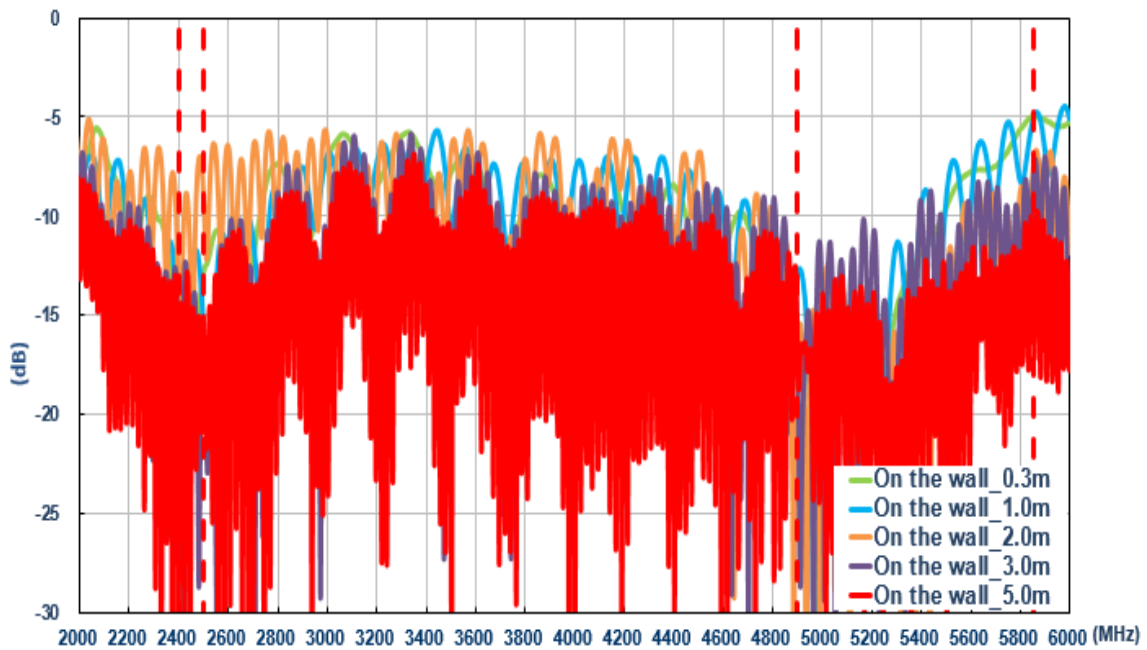

6.10.2 Return Loss (Wi-Fi MIMO 2)

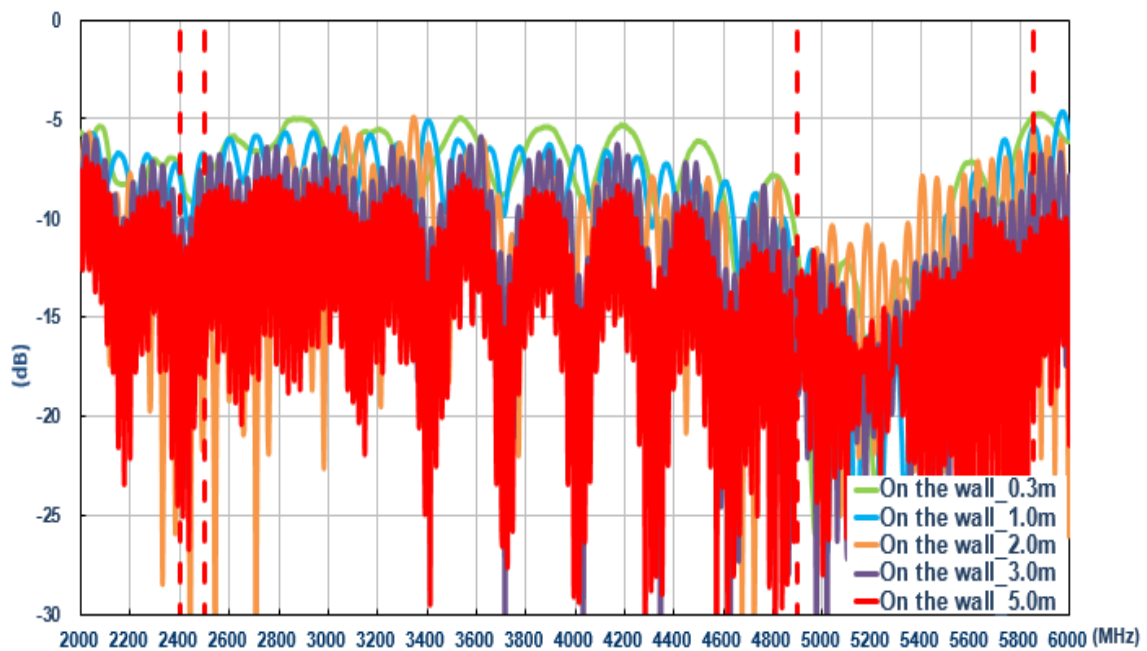

6.10.3 Isolation (Wi-Fi)

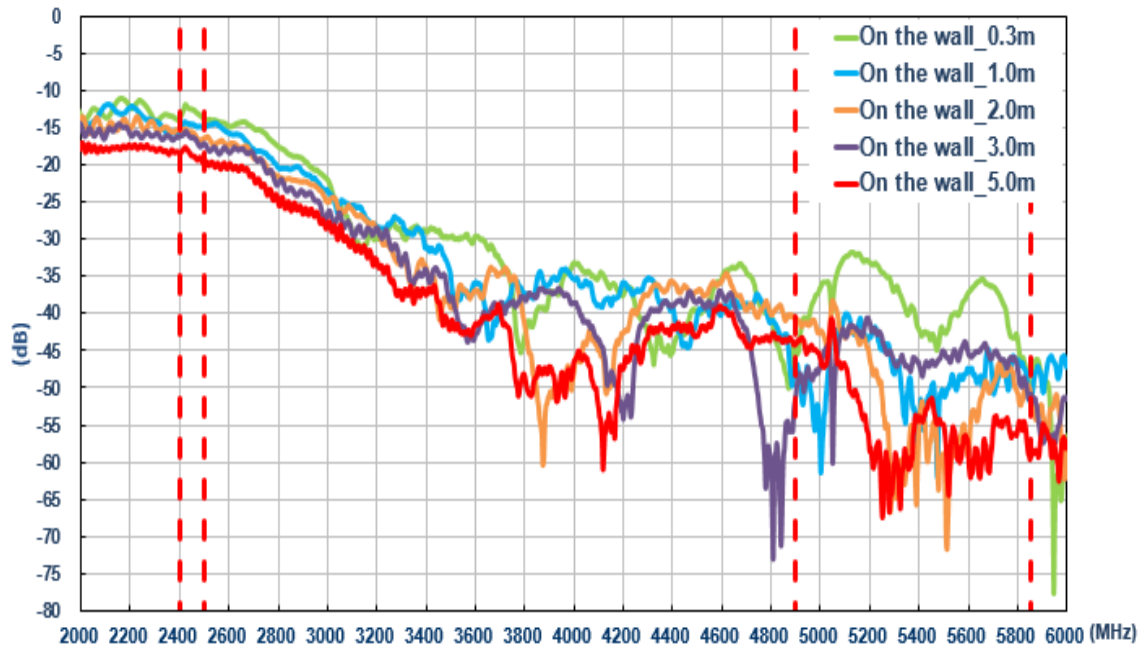

6.10.4 Efficiency (Wi-Fi MIMO 1)

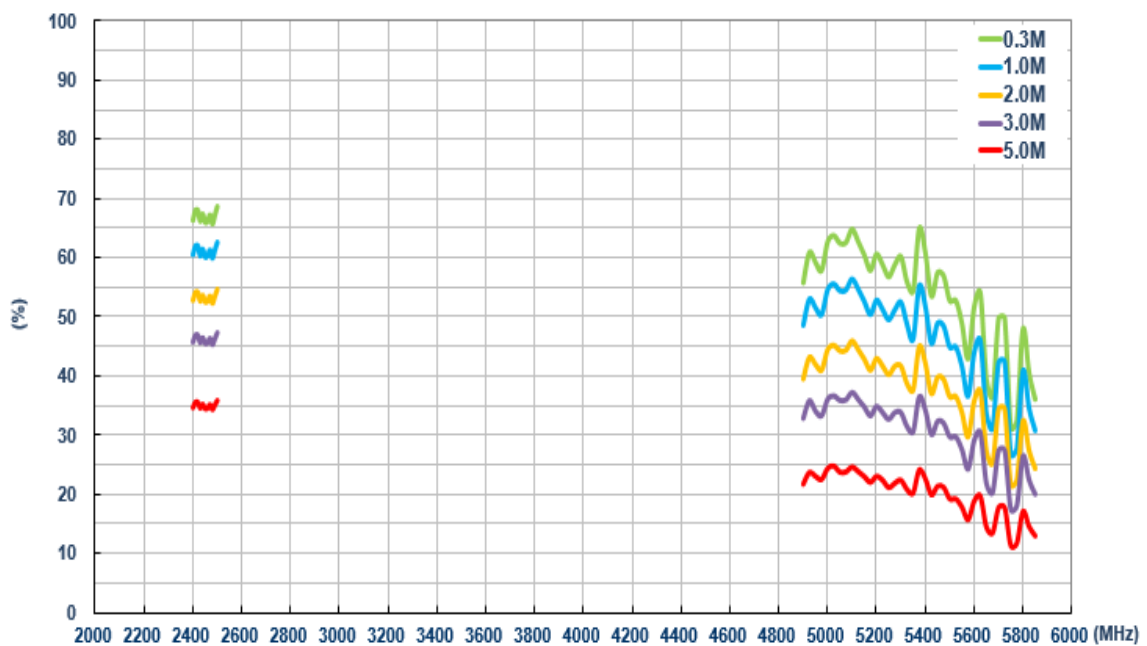

6.10.5 Efficiency (Wi-Fi MIMO 2)

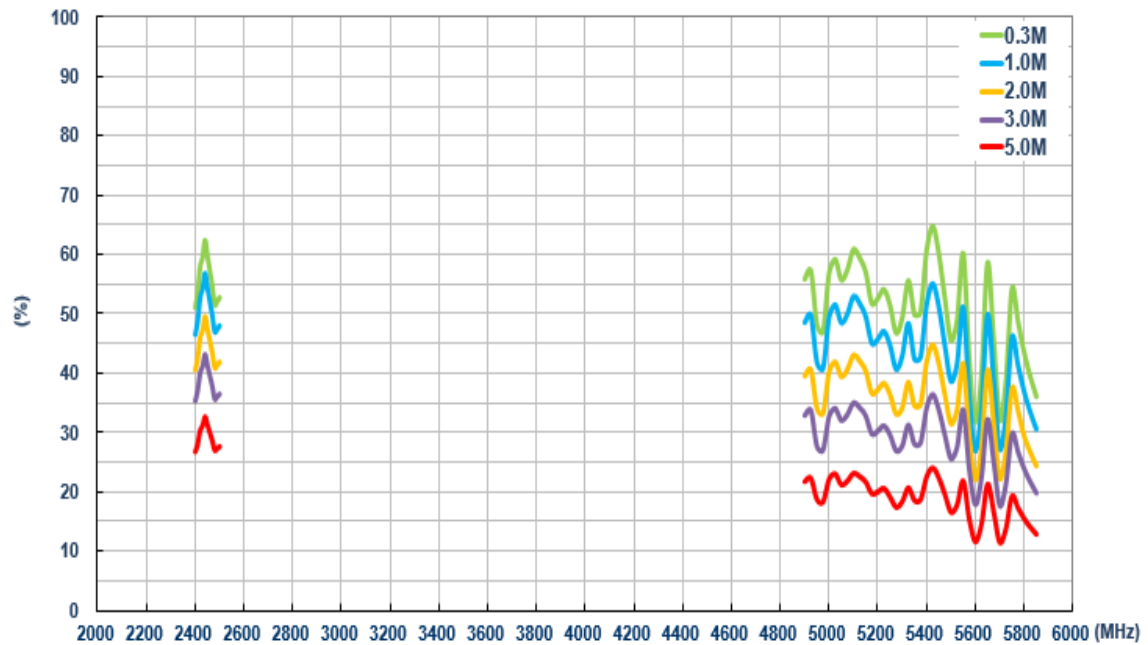

6.10.6 Average Gain (Wi-Fi MIMO 1)

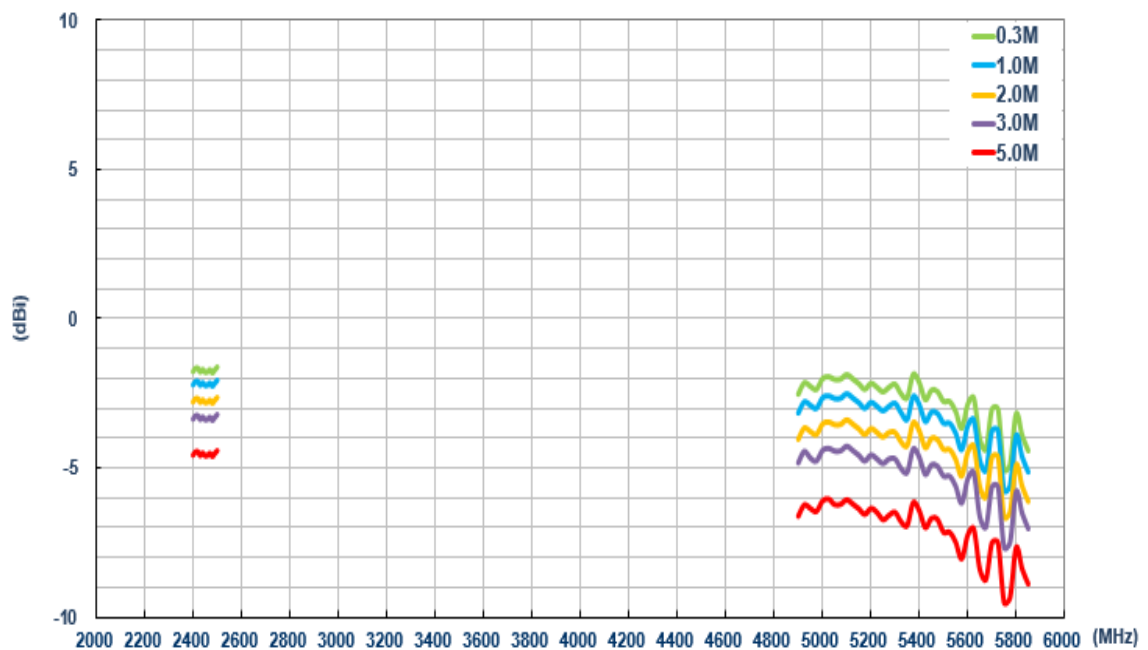

6.10.7 Average Gain (Wi-Fi MIMO 2)

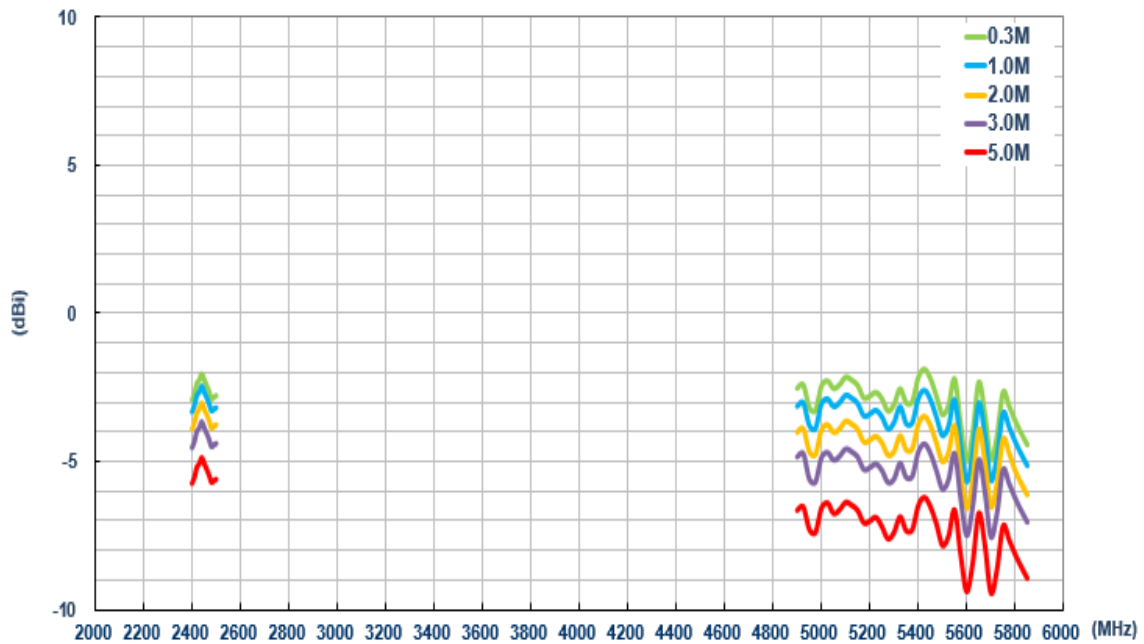

6.10.8 Peak Gain (Wi-Fi MIMO 1)

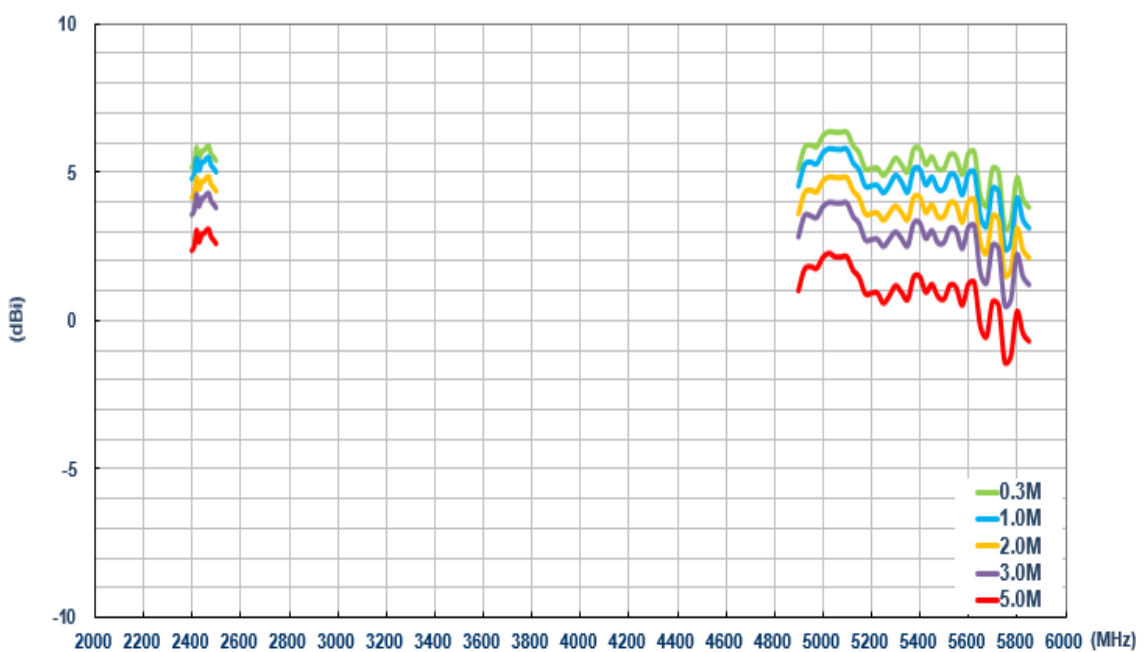

6.10.9 Peak Gain (Wi-Fi MIMO 2)

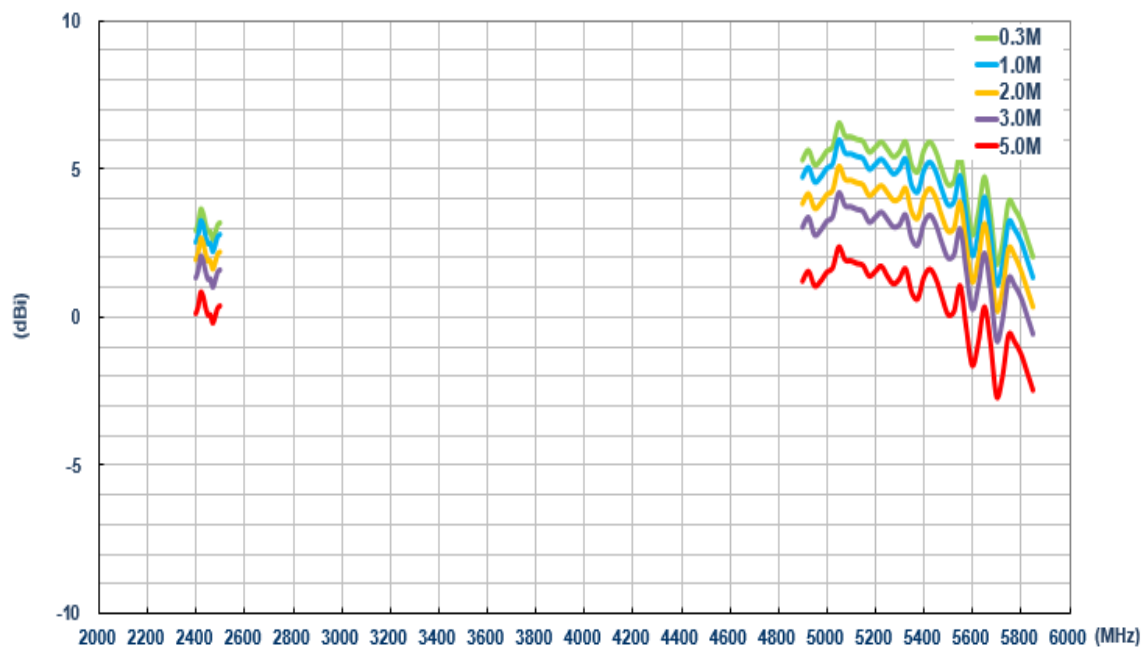

7. Installation Instructions

Introduction

Following these guidelines will help ensure that your Taoglas Guardian antenna is installed correctly. The Guardian is simply mounted via a wall mount bracket, details outlined below.



Electrical Safety

The Pantheon contain an active GPS/GNSS antenna.
Rated voltage: 3-5VDC Rated current: 20mA maximum

The supply to this device must be provided with overcurrent protection of 1A maximum.

Power consumption@1.8V (mA) 8.7 mA

Power consumption@3.0V (mA) 9.0 mA

Power consumption@5.5V (mA) 11 mA

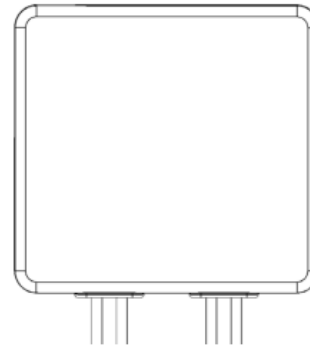

Installation Requirements

Antenna Components:

- Antenna Enclosure x 1
- Mounting Bracket x1
- Screws x2
- Rawl Plugs x2

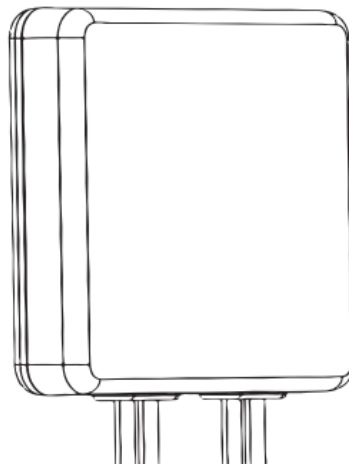
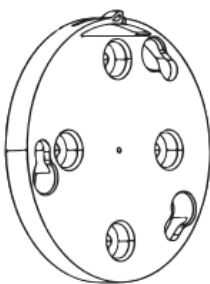

Tools Required:

Screwdriver, drill, M4 [Gauge 8]

Wall Mount

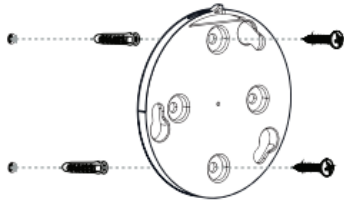

1. Using the mounting bracket as guide, mark the position of the wall screws to the desired location of the bracket. Drill holes for the wall mount studs (6mm [1/4"] diameter, min. 25mm [1"] depth) and secure the studs in place. Insert screws through the bracket holes and into the wall studs. Tighten the screw to secure the mounting bracket to the wall.

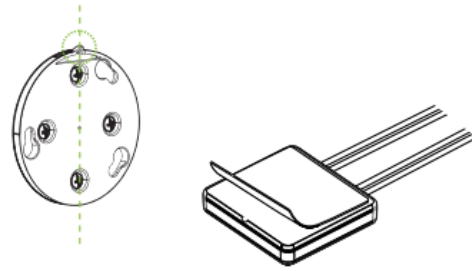

2. Connect the the back of the antenna to the brakcet via the 3 built-in mounting points on the rear of the antenna.
Note: The locking mechanism is highlighted in green.

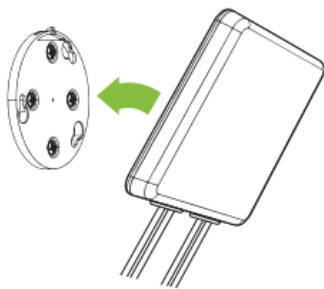

3. Press the antenna into the open area of the holes on the bracket via the mounting points.
Note: The antenna and bracket should be mounted level on the horizontal plane.

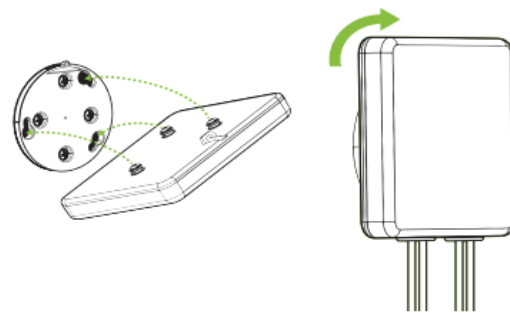

4. Rotate the Antenna in to the bracket by turning slightly. The locking mechanism on the bracket and back of the antenna should be connected together at the point.

5. Completed Installation of the .

Note: The bracket should be flush with antenna.

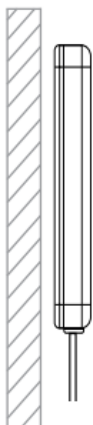

Notices



Caution

To comply with FCC RF Exposure requirements in section 1.1310 of the FCC Rules, antennas used with this device must be installed to provide a separation distance of at least 20 cm from all persons to satisfy RF exposure compliance.



Warning

Do not Operate the transmitter when someone is within 20 cm of the antenna.
Do not operate the equipment in an explosive atmosphere.



European Waste Electronic Equipment Directive 2002/96/EC

Please ensure that your old Waste Electricals and Electronics are recycled do not throw them away into standard waste.

Waiver: This document represents information compiled by Taoglas to the best of our current knowledge. This is not intended to be used as a representation or warranty of fitness of the products described for any particular purpose. This document details guidelines for general information purposes only. When planning installations, always seek specialist advice and ensure that the products are always installed by a properly qualified installer in accordance with applicable regional laws and regulations.

All copyrights, trademarks and any other intellectual property rights related are owned by Taoglas Group Holdings Limited.

Changelog for the datasheet

SPE-18-8-023 – MA950.A.LBICG.005.wm

Revision: C (Current Versions)

Date:	2023-07-21
Notes:	Updated Installation Instructions
Author:	Cesar Sousa

Previous Revisions

Revision: B

Date:	2022-07-06
Notes:	Updated Drawing
Author:	Cesar Sousa

Revision: A (Original First Release)

Date:	2019-04-16
Notes:	Initial Datasheet Release
Author:	Yu Kai Yeung



TAOGLAS®

www.taoglas.com

Mouser Electronics

Authorized Distributor

Click to View Pricing, Inventory, Delivery & Lifecycle Information:

[Taoglas:](#)

[MA950.A.LBICG.005.wm](#)