



TAOGLAS®



Datasheet

Guardian 4in1 Adhesive Mount Antenna

Part No:
MA961.A.BICG.002

Description:

Guardian 4in1 Adhesive Mount Antenna 2*LTE MIMO and 2*Wi-Fi MIMO

Features:

- Low-profile Housing
- 2* 4G/LTE MIMO 698-4000MHz
- 2* Wi-Fi MIMO 2.4GHz/5.8GHz
- Worldwide 4G Bands including fallback to 3G and 2G
- IP67 Waterproof Enclosure
- Dims: 146*134*20mm
- Cables: 3M Low Loss TGC-200 and RG174
- Connectors: SMA(M)/RP-SMA(M)
- Cables and Connectors Customizable
- RoHS Compliant RoHS & REACH Compliant

1.	Introduction	3
2.	Specifications	4
3.	Antenna Characteristics	8
4.	Mechanical Drawing	27
5.	Packaging	28
	Changelog	29

Taoglas makes no warranties based on the accuracy or completeness of the contents of this document and reserves the right to make changes to specifications and product descriptions at any time without notice. Taoglas reserves all rights to this document and the information contained herein.

Reproduction, use or disclosure to third parties without express permission is strictly prohibited.



1. Introduction



The MA961 Guardian is a next generation combination antenna. The first panel antenna worldwide designed for IoT Gateway and Router devices. It is a low profile 4in1 wall mount antenna. This unique product delivers powerful worldwide 4G LTE MIMO antenna technology at 698-4000MHz bands and dual band Wi-Fi. It is a heavy-duty, fully IP67 waterproof external M2M antenna for use by RF professionals in IoT Gateway and Routers, HD Video Streaming, Transportation and Remote Monitoring Applications.

This antenna delivers powerful MIMO antenna technology for worldwide 4G LTE bands at 698-4000MHz bands and dual 2.4/5.8GHz Wi-Fi. It enables designers to cover a wide range of technologies by installing a single antenna.

4G wireless applications demand high speed data uplink and downlink. High efficiency and high gain MIMO antennas are necessary to achieve the required signal to noise ratio and throughput required to solve these challenges. Taoglas also takes care to have high isolation among these antennas to prevent self-interference. Low loss cables used to keep efficiency high over long cable lengths.

The housing is made of durable ASA, is IP67 waterproof and comes with 3M foam adhesive. The antenna can be mounted internally or externally on a vehicle or building. The MA961 comes with 3 meters TGC-200 cable as standard. Customized cables and connector versions are also available. Contact your regional Taoglas customer support for more information on how to integrate the MA961 or sales support.

2. Specifications

4G/3G/2G MIMO1 Antenna									
Frequency (MHz)	LTE700	GSM850	GSM900	DCS	PCS	UMTS1	LTE2600	LTE3500	
	698~803	824~894	880~960	1710~1880	1850~1990	1920~2170	2490~2690	3300~3600	
Efficiency (%)									
In free space	30cm	80.59	64.37	61.48	67.87	72.91	76.16	47.65	55.23
	1M	76.15	61.48	58.71	61.90	66.50	70.02	43.45	49.00
	2M	71.06	56.46	53.55	55.17	58.52	61.35	37.52	41.47
	3M	65.87	52.33	49.65	49.03	51.74	54.25	32.54	35.03
	5M	56.97	44.54	41.98	38.65	40.59	42.27	24.39	25.12
Average Gain (dB)									
In free space	30cm	-0.95	-1.92	-2.11	-1.69	-1.37	-1.19	-3.42	-2.64
	1M	-1.19	-2.12	-2.31	-2.09	-1.77	-1.55	-3.82	-3.17
	2M	-1.49	-2.49	-2.71	-2.59	-2.33	-2.13	-4.45	-3.89
	3M	-1.82	-2.82	-3.04	-3.10	-2.86	-2.66	-5.08	-4.62
	5M	-2.45	-3.52	-3.77	-4.13	-3.92	-3.75	-6.33	-6.07
Peak Gain (dBi)									
In free space	30cm	3.83	3.32	1.83	4.23	4.23	4.70	4.11	3.36
	1M	3.63	3.12	1.63	3.83	3.83	4.30	3.71	3.36
	2M	3.33	2.82	1.23	3.33	3.33	3.80	3.11	2.66
	3M	3.03	2.42	0.85	2.73	2.73	3.20	2.51	1.86
	5M	2.33	1.72	0.15	1.73	1.73	2.10	1.31	0.46
4G/3G/2G MIMO2 Antenna									
Efficiency (%)									
In free space	30cm	80.00	63.77	59.51	67.36	72.20	76.03	57.82	64.24
	1M	75.66	60.90	56.84	61.43	65.84	69.92	52.74	56.94
	2M	70.61	55.93	51.83	54.75	57.94	61.24	45.51	48.21
	3M	65.44	51.84	48.09	48.66	51.23	54.16	39.45	40.77
	5M	56.55	44.12	40.66	38.36	40.18	42.20	29.58	29.22
Average Gain (dB)									
In free space	30cm	-0.99	-1.96	-2.26	-1.72	-1.42	-1.20	-2.47	-1.93
	1M	-1.23	-2.16	-2.46	-2.12	-1.82	-1.56	-2.87	-2.46
	2M	-1.53	-2.53	-2.86	-2.62	-2.37	-2.14	-3.50	-3.18
	3M	-1.86	-2.86	-3.19	-3.13	-2.91	-2.67	-4.13	-3.91
	5M	-2.49	-3.56	-3.92	-4.16	-3.96	-3.76	-5.38	-5.36
Peak Gain (dBi)									
In free space	30cm	4.86	3.06	2.81	4.41	4.67	4.56	3.95	4.15
	1M	4.66	2.86	2.61	4.01	4.27	4.19	3.55	3.55
	2M	4.36	2.56	2.21	3.51	3.77	3.66	2.95	2.85
	3M	4.06	2.16	1.91	2.99	3.17	3.06	2.35	2.15
	5M	3.36	1.46	1.21	1.99	2.17	2.06	1.15	0.65
Impedance		50Ω							
Polarization		Linear							
VSWR		< 3							
Cable		3 meters TGC-200 standard, fully customizable							
Connector		SMA(M) standard, fully customizable							

ELECTRICAL			
Frequency (MHz)		2400~2500	4900~5850
Efficiency (%)			
MIMO_1	30cm	69.77	59.81
	1M	63.63	51.43
	2M	55.42	41.67
	3M	48.27	33.81
	5M	36.62	22.18
MIMO_2	30cm	70.19	59.69
	1M	64.01	51.32
	2M	55.75	41.57
	3M	48.56	33.71
	5M	36.84	22.12
Average Gain (dBi)			
MIMO_1	30cm	-1.57	-2.27
	1M	-1.97	-2.92
	2M	-2.57	-3.84
	3M	-3.17	-4.75
	5M	-4.37	-6.58
MIMO_2	30cm	-1.54	-2.25
	1M	-1.94	-2.91
	2M	-2.54	-3.82
	3M	-3.14	-4.73
	5M	-4.34	-6.56
Peak Gain (dBi)			
MIMO_1	30cm	4.87	4.95
	1M	4.37	4.26
	2M	3.77	3.36
	3M	3.17	2.46
	5M	1.97	0.66
MIMO_2	30cm	4.93	5.09
	1M	4.43	4.39
	2M	3.83	3.49
	3M	3.23	2.59
	5M	2.03	0.79
Impedance	50Ω		
Polarization	Linear		
VSWR	< 3		
Cable	3 meter TGC-200 standard, fully customizable		
Connector	SMA(M) standard, fully customizable		

MECHANICAL	
Antenna Dimensions	146*134*20mm
Casing	ABS+PC
Base and thread	Nickel Plated Aluminium
Weight	586g
Ingress Protection Rating	IP67
ENVIRONMENTAL	
Operation Temperature	-40°C to 85°C
Storage Temperature	-40°C to 90°C
Humidity	Non-condensing 65°C 95% RH

LTE Bands				
Band Number	LTE / LTE-Advanced / WCDMA / HSPA / HSPA+ / TD-SCDMA			
	Uplink	Downlink	MIMO 1	MIMO 2
1	UL: 1920 to 1980	DL: 2110 to 2170	✓	✓
2	UL: 1850 to 1910	DL: 1930 to 1990	✓	✓
3	UL: 1710 to 1785	DL: 1805 to 1880	✓	✓
4	UL: 1710 to 1755	DL: 2110 to 2155	✓	✓
5	UL: 824 to 849	DL: 869 to 894	✓	✓
7	UL: 2500 to 2570	DL: 2620 to 2690	✓	✓
8	UL: 880 to 915	DL: 925 to 960	✓	✓
9	UL: 1749.9 to 1784.9	DL: 1844.9 to 1879.9	✓	✓
11	UL: 1427.9 to 1447.9	DL: 1475.9 to 1495.9	✗	✗
12	UL: 699 to 716	DL: 729 to 746	✓	✓
13	UL: 777 to 787	DL: 746 to 756	✓	✓
14	UL: 788 to 798	DL: 758 to 768	✓	✓
17	UL: 704 to 716	DL: 734 to 746 (LTE only)	✓	✓
18	UL: 815 to 830	DL: 860 to 875 (LTE only)	✓	✓
19	UL: 830 to 845	DL: 875 to 890	✓	✓
20	UL: 832 to 862	DL: 791 to 821	✓	✓
21	UL: 1447.9 to 1462.9	DL: 1495.9 to 1510.9	✗	✗
22	UL: 3410 to 3490	DL: 3510 to 3590	✓	✓
23	UL: 2000 to 2020	DL: 2180 to 2200 (LTE only)	✓	✓
24	UL: 1625.5 to 1660.5	DL: 1525 to 1559 (LTE only)	✓	✗
25	UL: 1850 to 1915	DL: 1930 to 1995	✓	✓
26	UL: 814 to 849	DL: 859 to 894	✓	✓
27	UL: 807 to 824	DL: 852 to 869 (LTE only)	✓	✓
28	UL: 703 to 748	DL: 758 to 803 (LTE only)	✓	✓
29	UL: -	DL: 717 to 728 (LTE only)	✓	✓
30	UL: 2305 to 2315	DL: 2350 to 2360 (LTE only)	✓	✓
31	UL: 452.5 to 457.5	DL: 462.5 to 467.5 (LTE only)	✗	✗
32	UL: -	DL: 1452 - 1496	✗	✗
35		1850 to 1910	✓	✓
38		2570 to 2620	✓	✓
39		1880 to 1920	✓	✓
40		2300 to 2400	✓	✓
41		2496 to 2690	✓	✓
42		3400 to 3600	✓	✓
43		3600 to 3800	✓	✓

*Covered bands represent greater than 20% efficiency

3. Antenna Characteristics

3.1 LTE_MIMO/Wi-Fi_MIMO Antenna

3.1.1 Test Setup

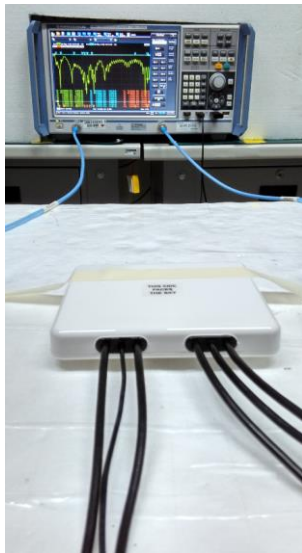

Free space



ABS

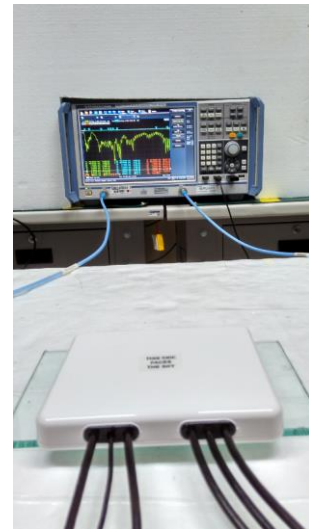

Glass

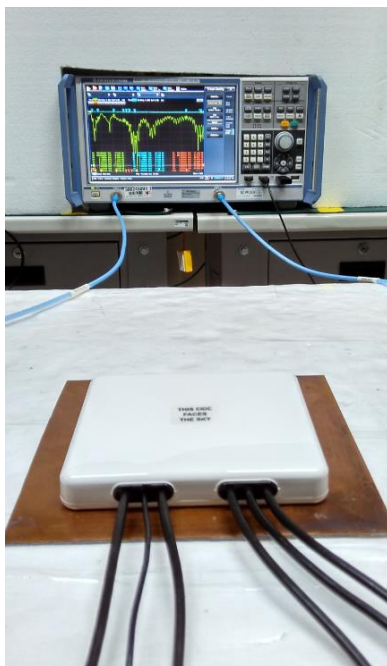

Metal

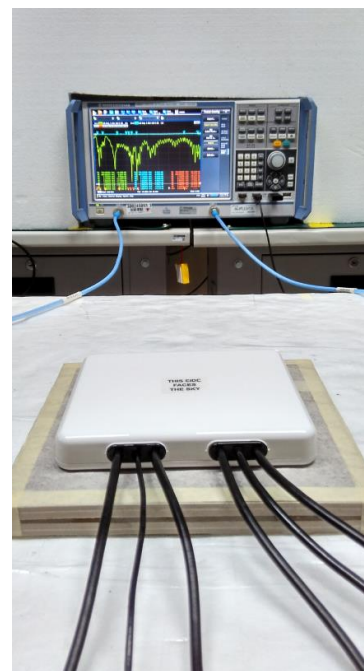

Wall

3.1.2 LTE_1 Antenna Return Loss

Performance in different environments with 1 meter cable length

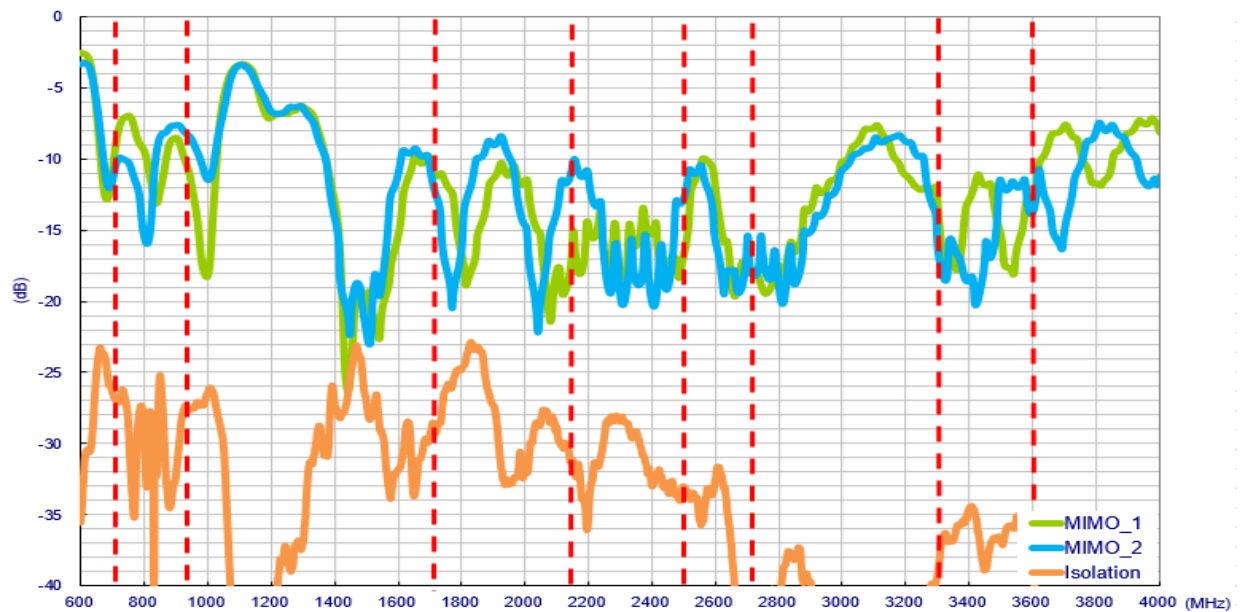

Figure 1. Return loss of MA961 LTE MIMO antenna in free space

3.1.3 LTE Antenna Efficiency

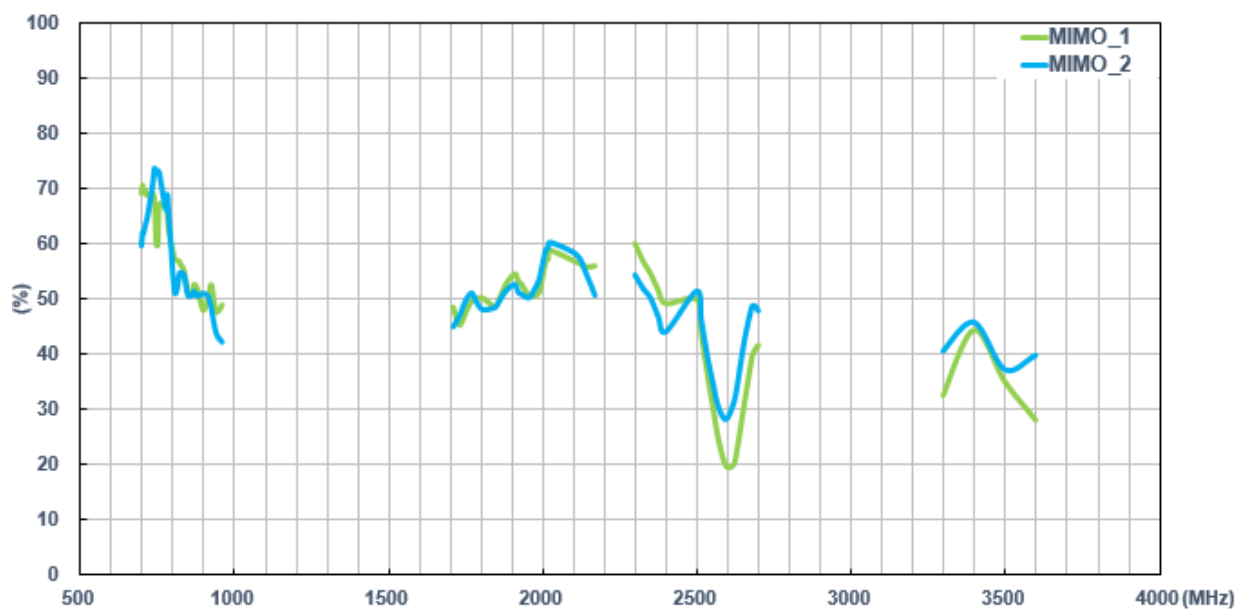

Figure 2. Efficiency of MA961 LTE MIMO antenna in free space

3.1.4 LTE Antenna Average Gain

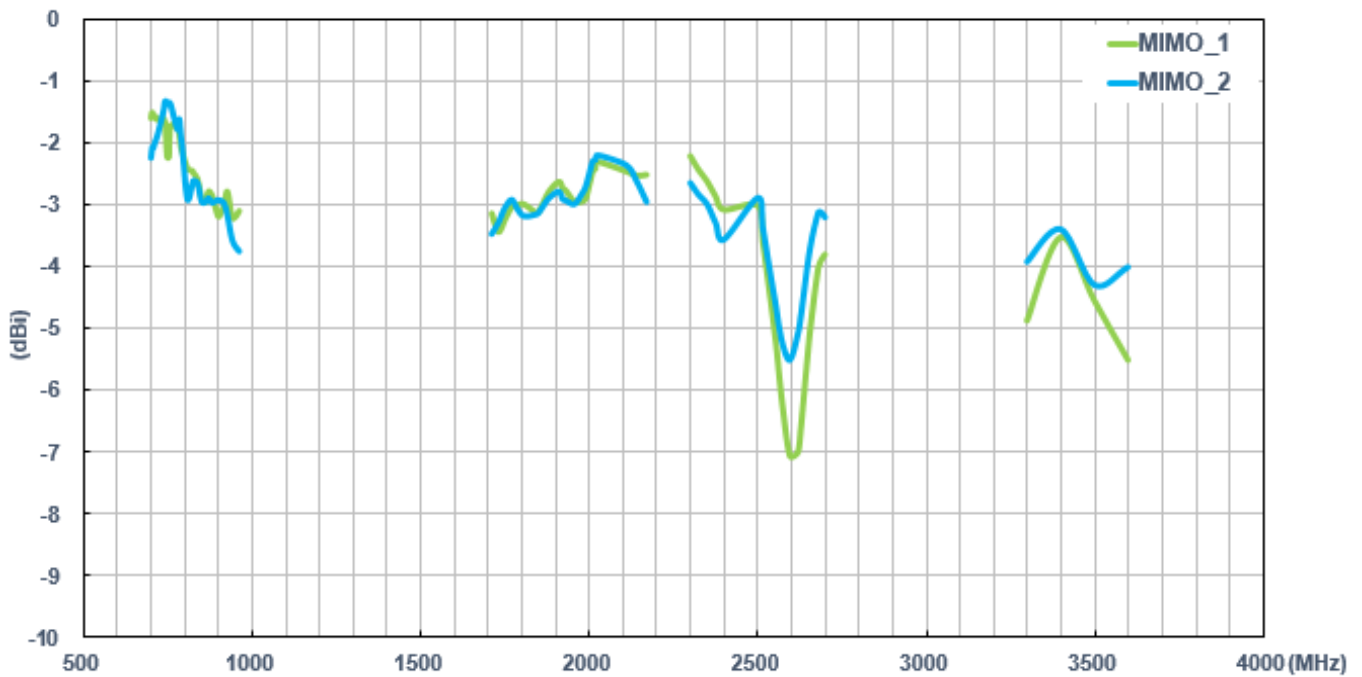

Figure 3. Average gain of MA961 LTE MIMO antenna in free space

3.1.5 LTE Antenna Peak Gain

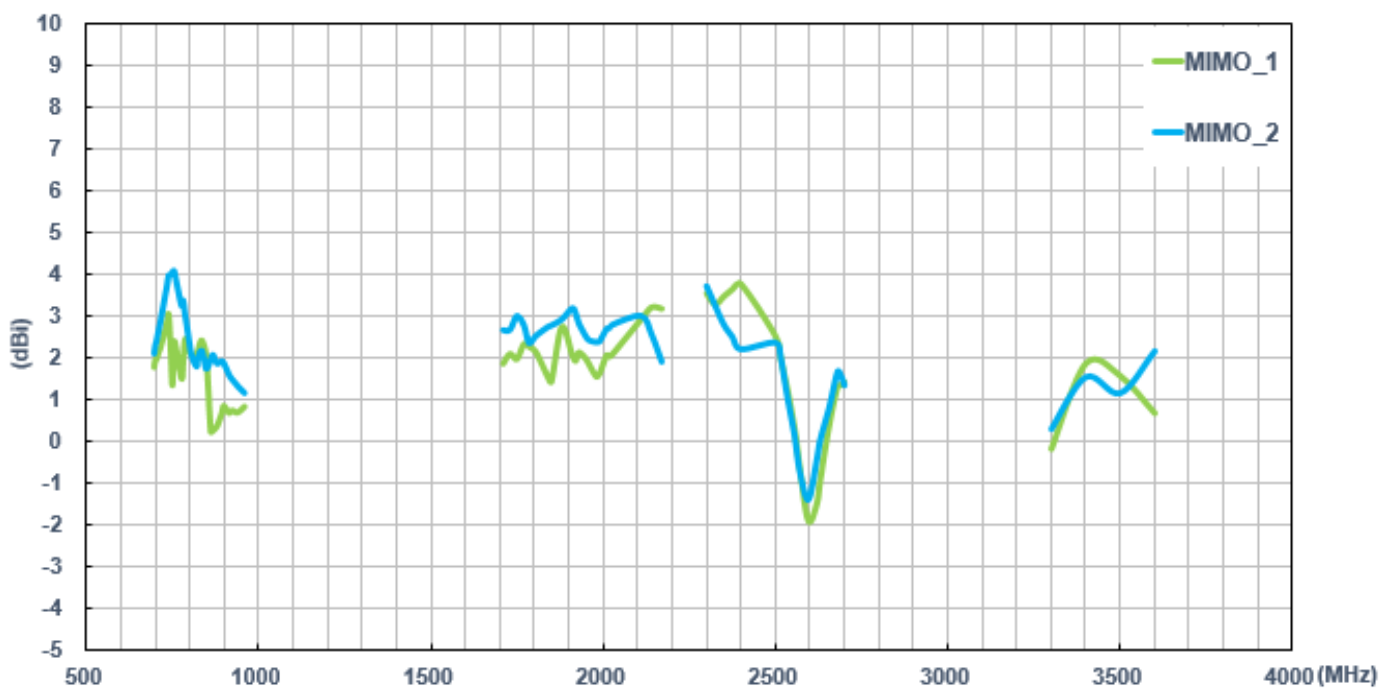

Figure 4. Peak gain of MA961 LTE MIMO antenna in the free space

3.2 Wi-Fi MIMO Antenna

3.2.1 Wi-Fi Antenna Return Loss and Isolation with 3-meter cable length

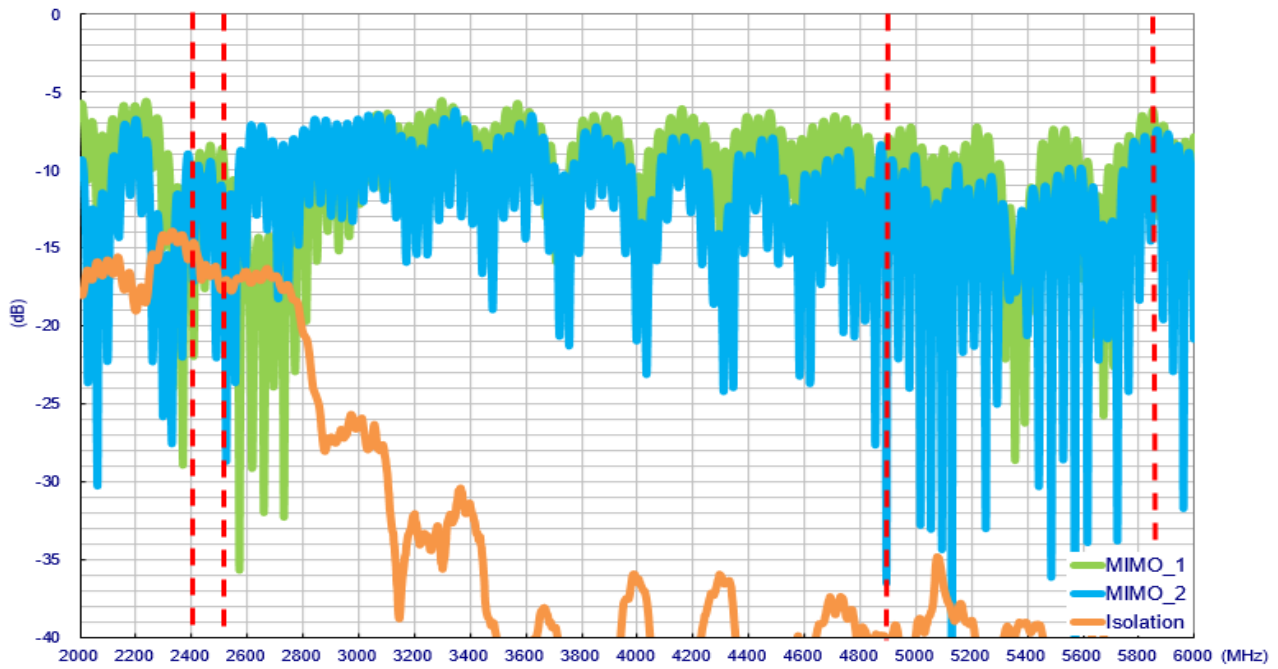

Figure 5. Return loss of MA961 Wi-Fi MIMO antenna in free space

3.2.2 Wi-Fi Antenna Efficiency

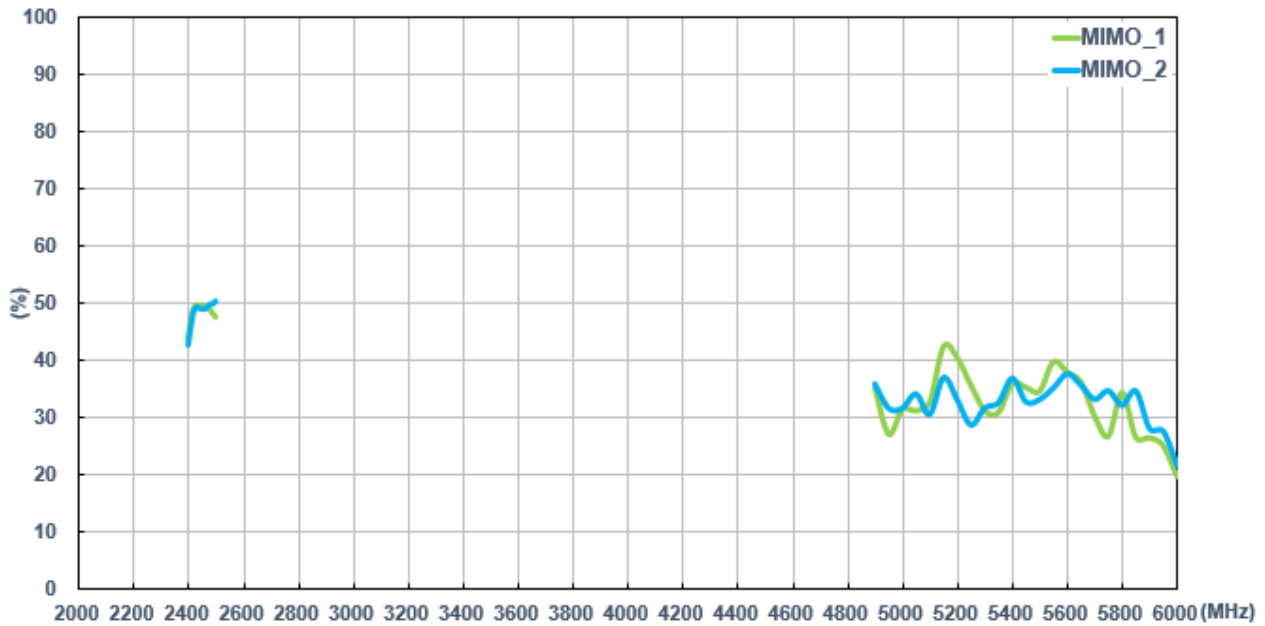

Figure 6. Efficiency of MA961 Wi-Fi MIMO antenna in free space

3.2.3 Wi-Fi Antenna Average Gain

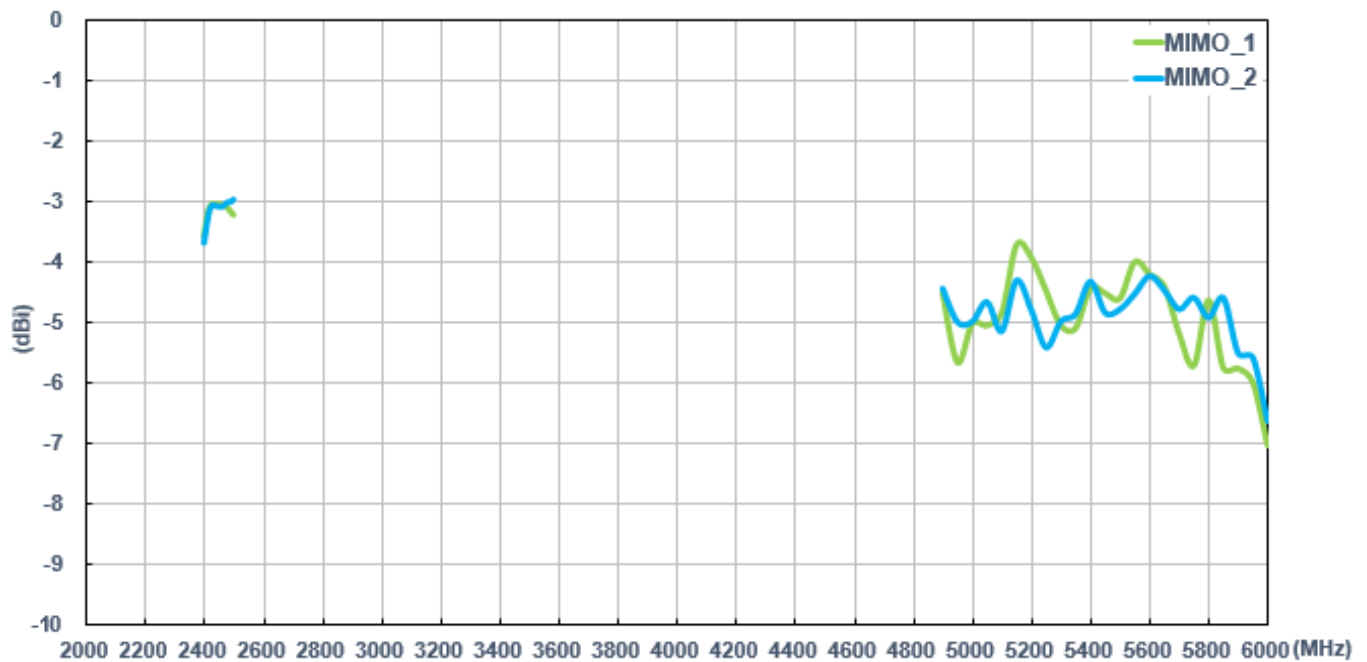

Figure 7. Average gain of MA961 Wi-Fi MIMO antenna in free space

3.2.4 Wi-Fi Antenna Peak Gain

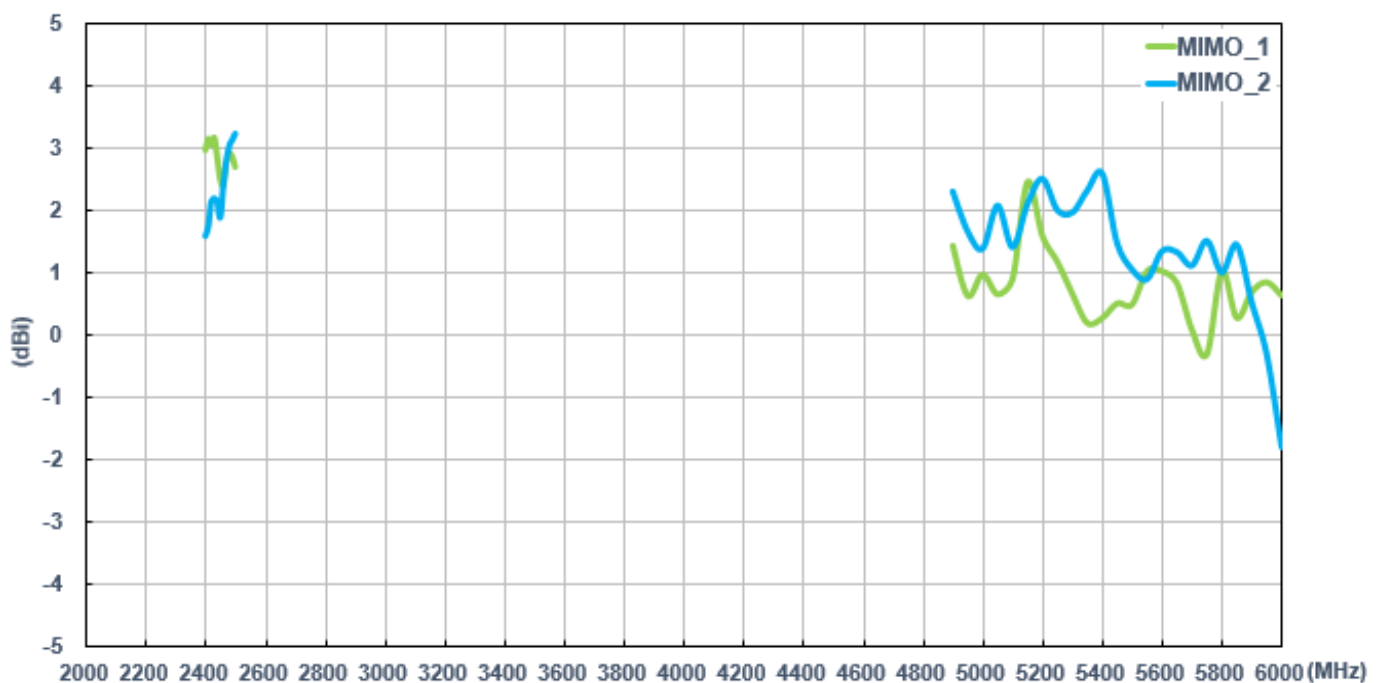
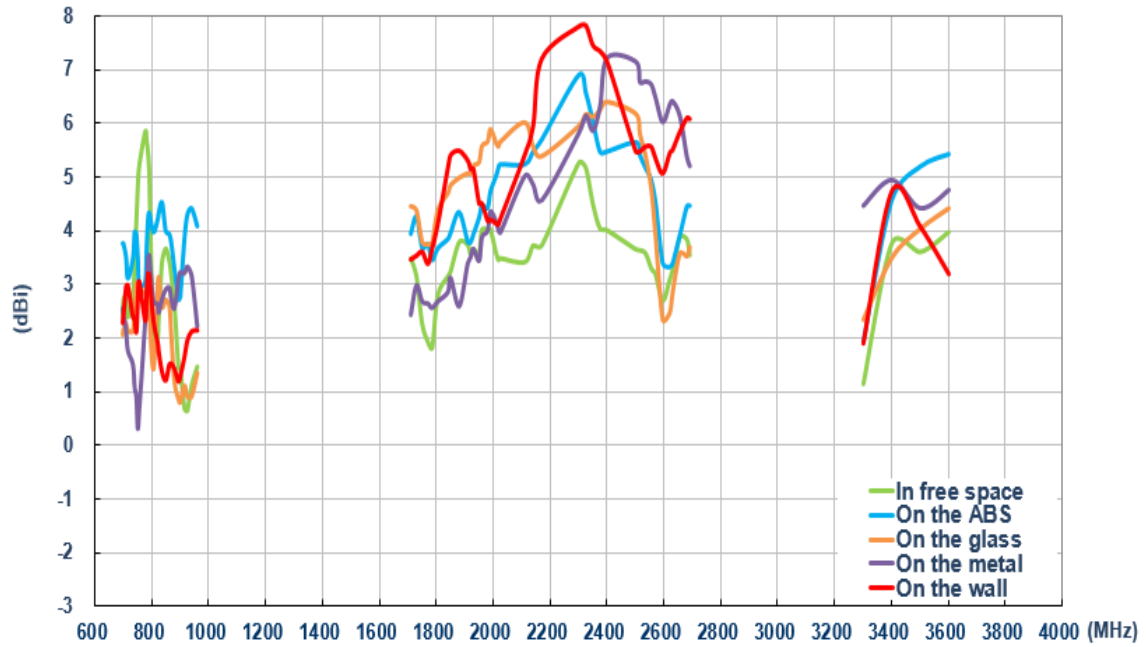

Figure 8. Peak gain of MA961 Wi-Fi MIMO antenna in the free space

3.2.5 LTE_2 Antenna Peak Gain

Performance in different environments with 1 meter cable length



3.3 Test Setup for Antenna Radiation Pattern (ETS Anechoic chamber)

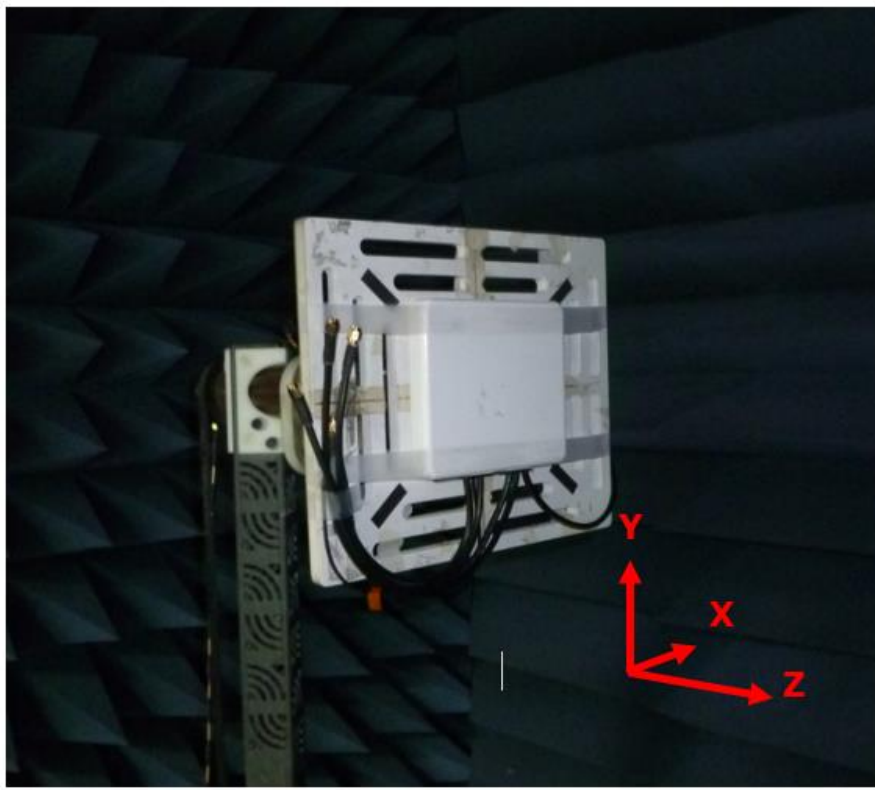

Free space

3.3.1 2D Radiation Patterns (LTE_MIMO1 with 3M cable length in free space)

XY Plane

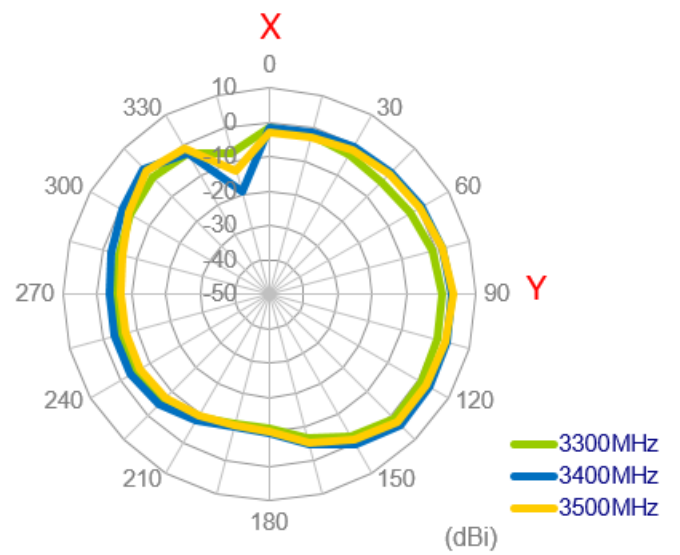
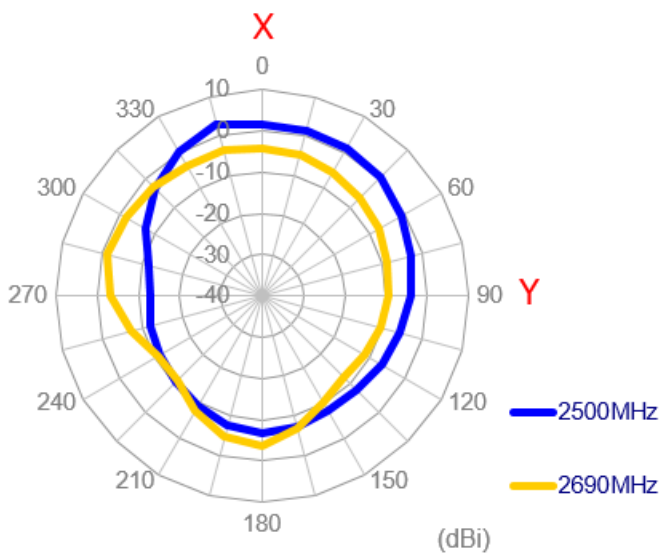
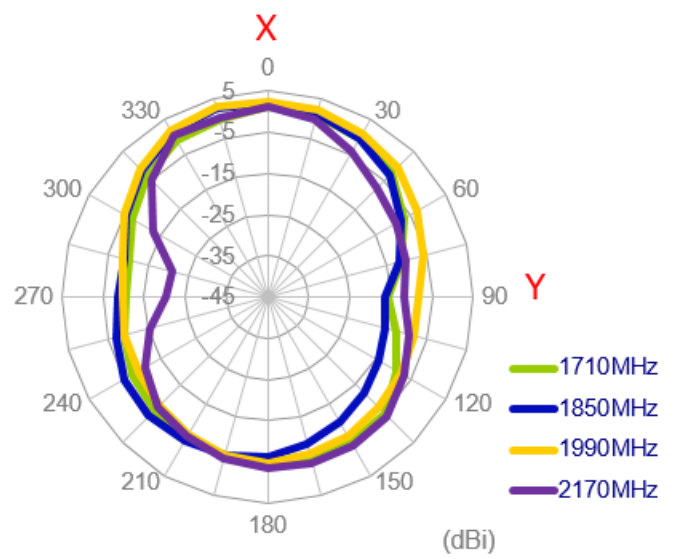
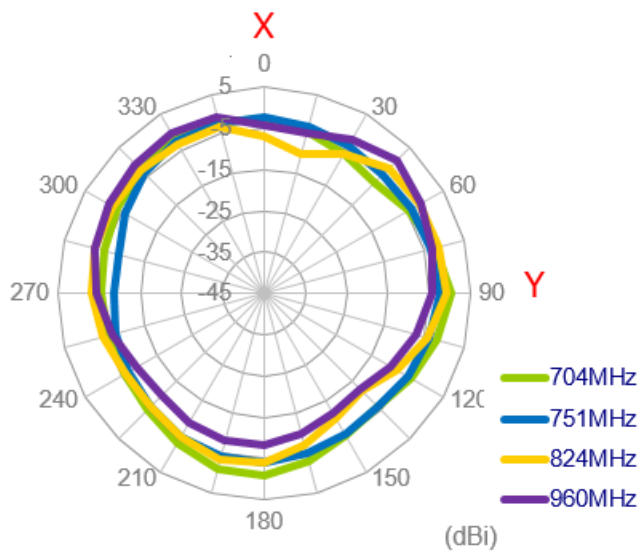

XZ Plane

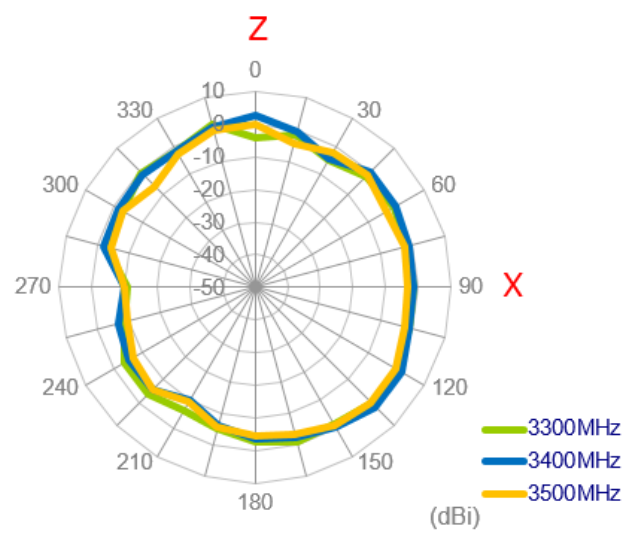
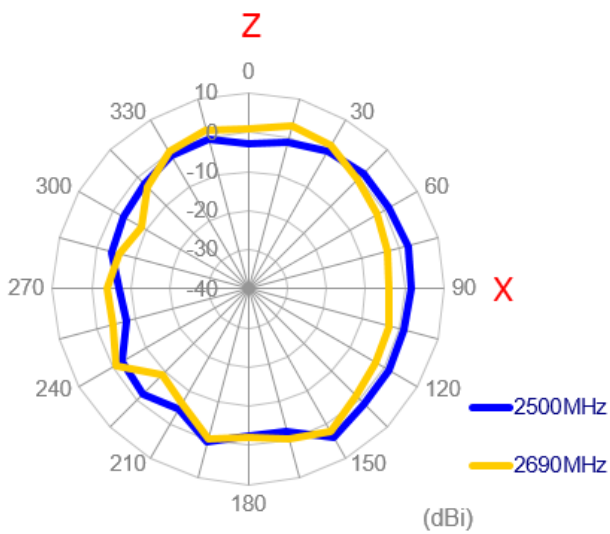
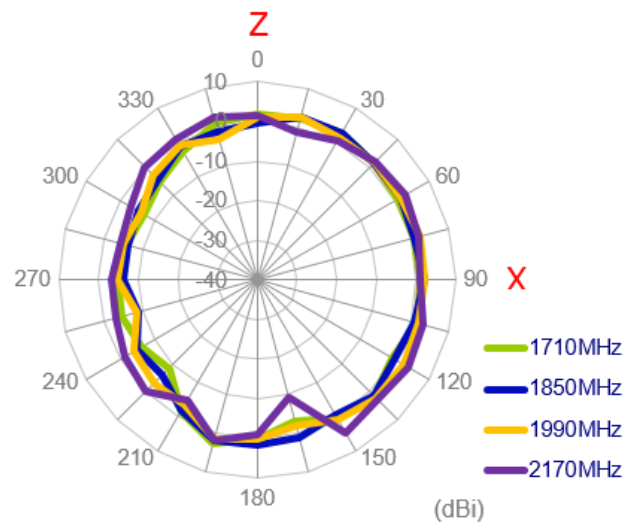
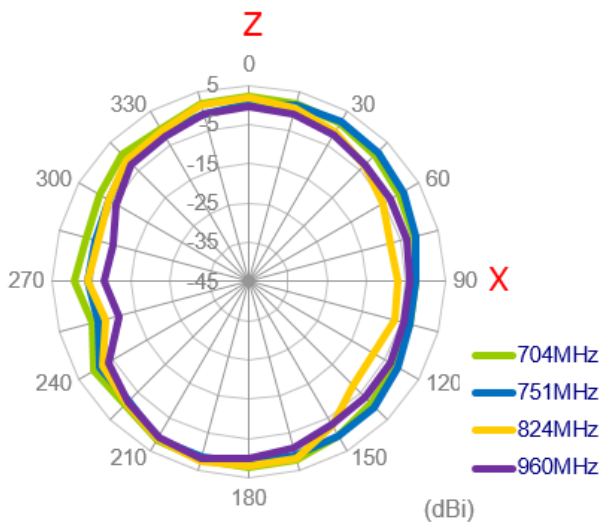

YZ Plane

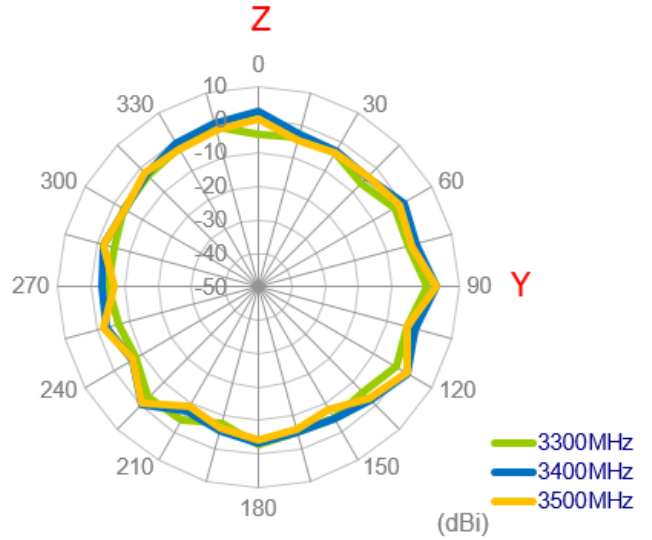
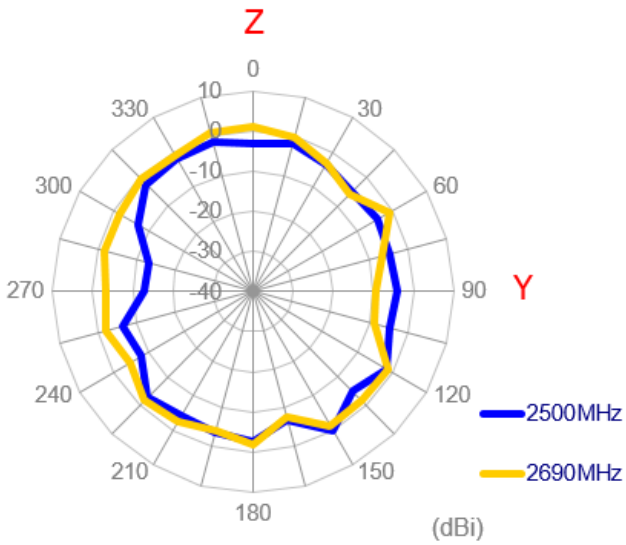
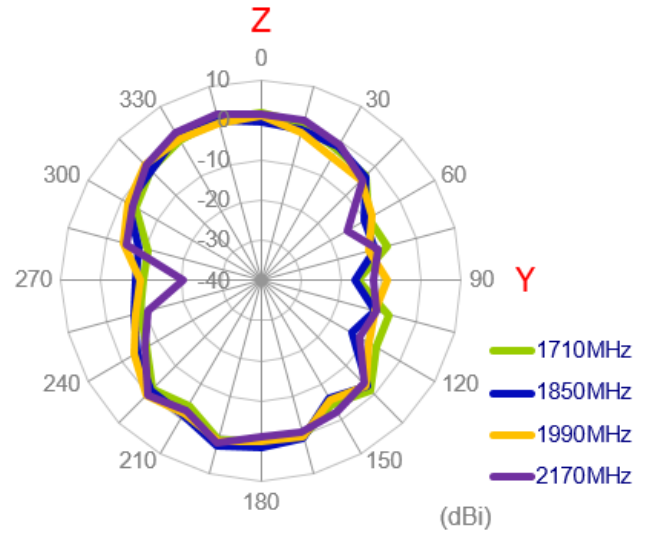
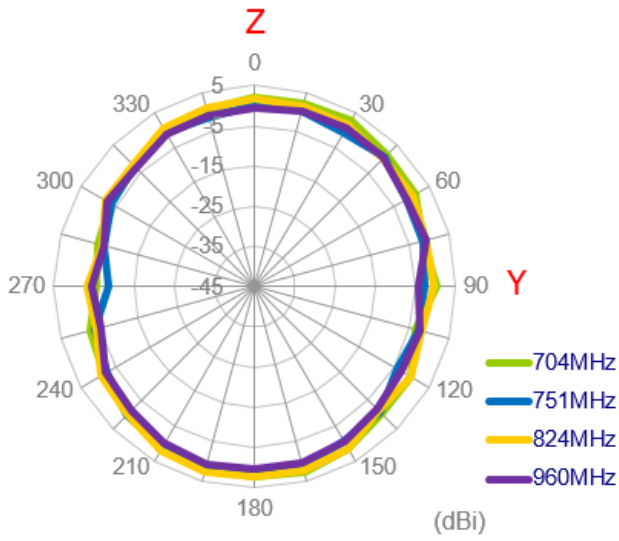

3.3.2 3D Radiation Patterns (LTE_MIMO1 with 3M cable length in free space)

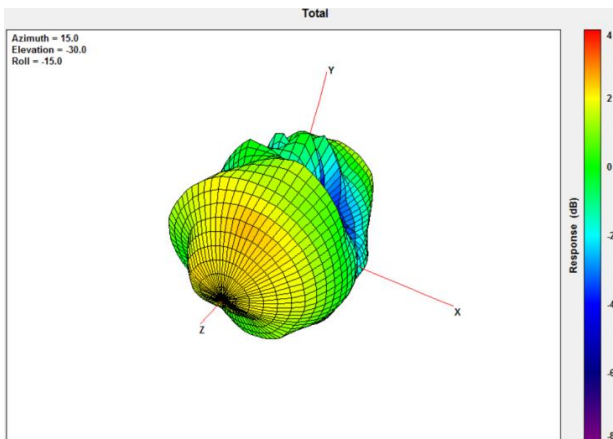

704MHz

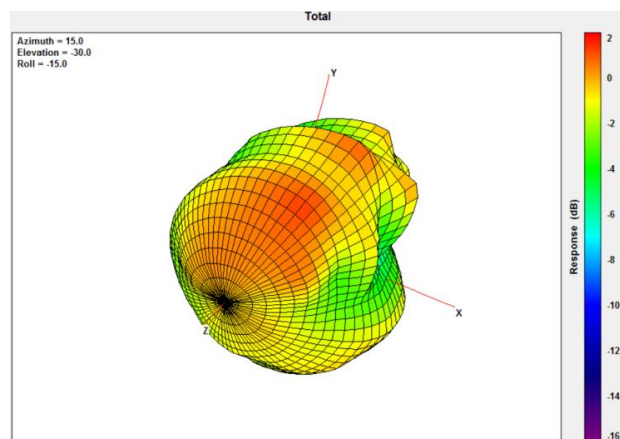

960MHz

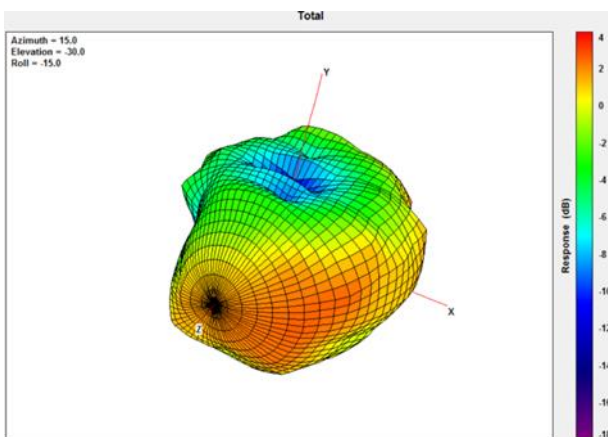

1710MHz

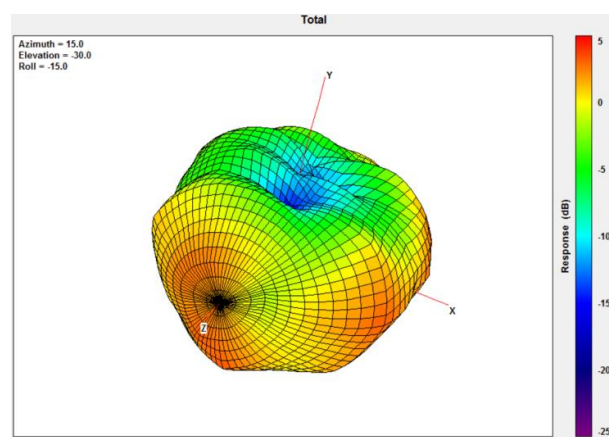

2170MHz

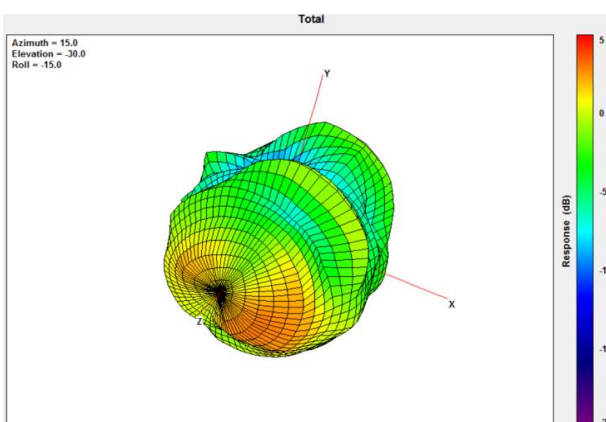

2690MHz

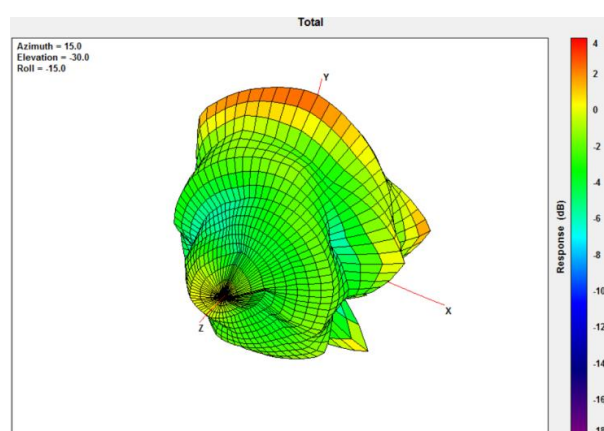

3500MHz

3.3.3 2D Radiation Patterns (LTE_MIMO2 with 3M cable length in free space)

XY Plane

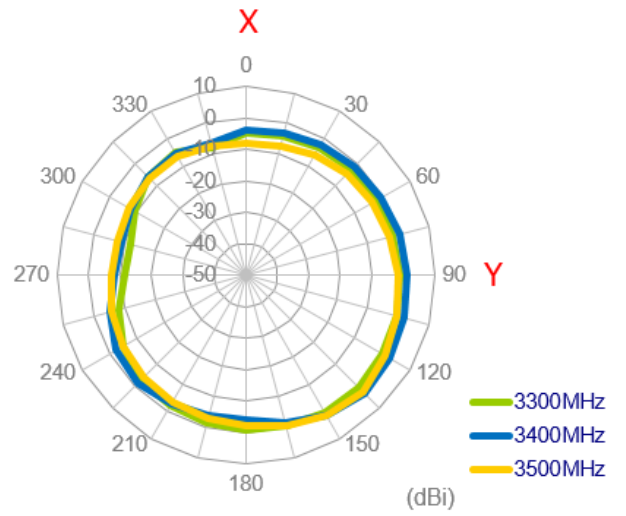
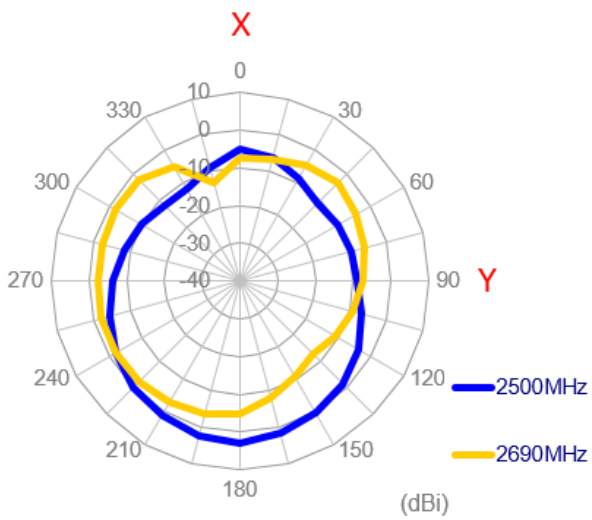
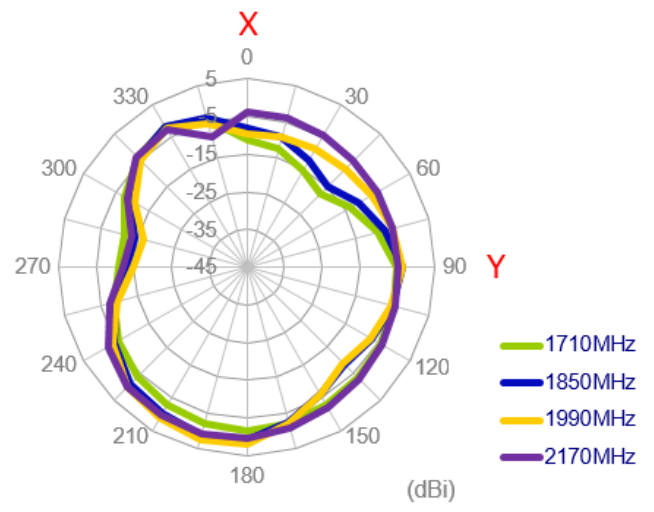
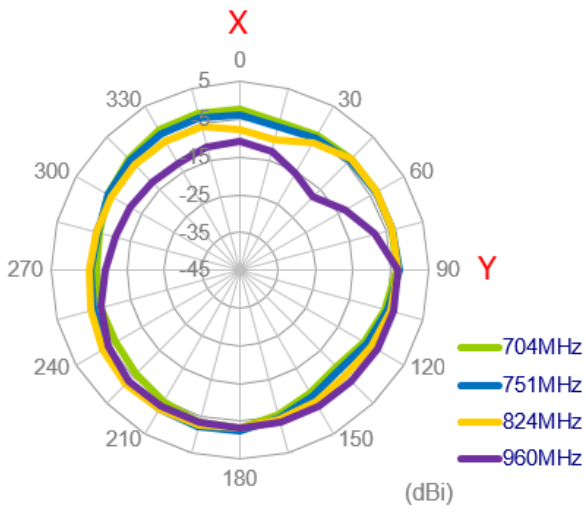

XZ Plane

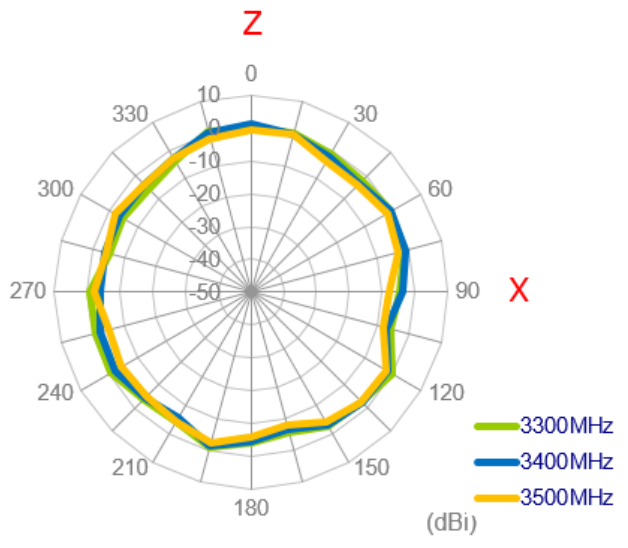
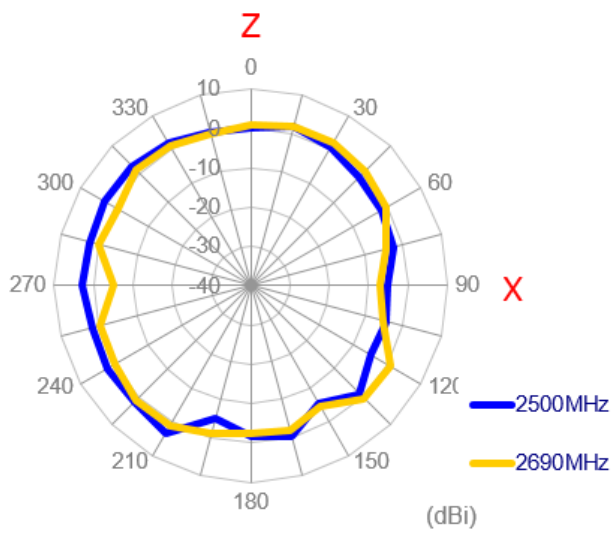
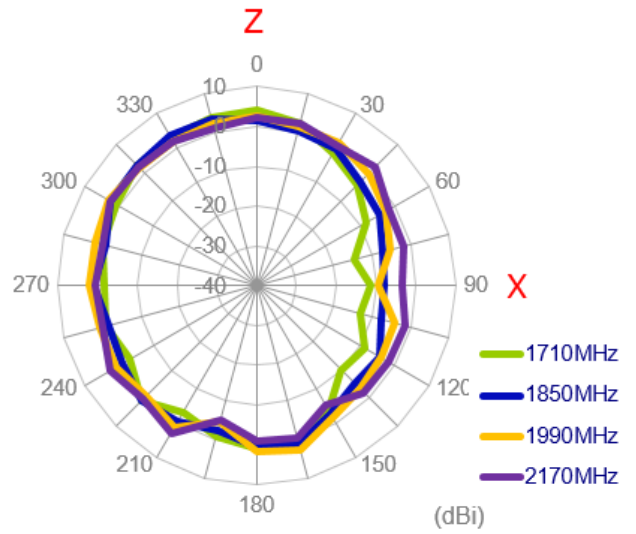
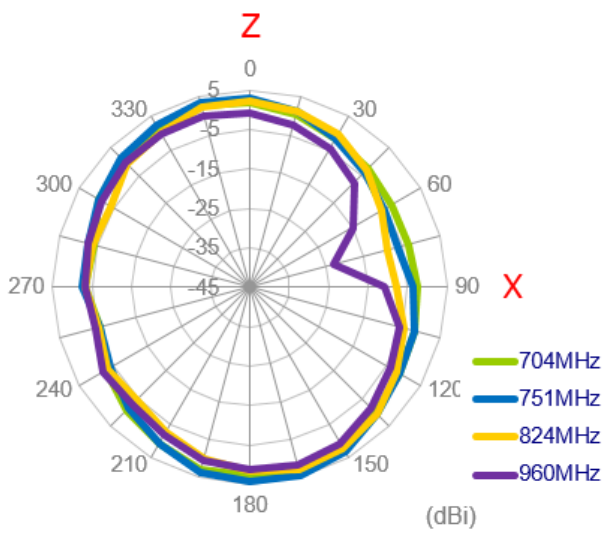

YZ Plane

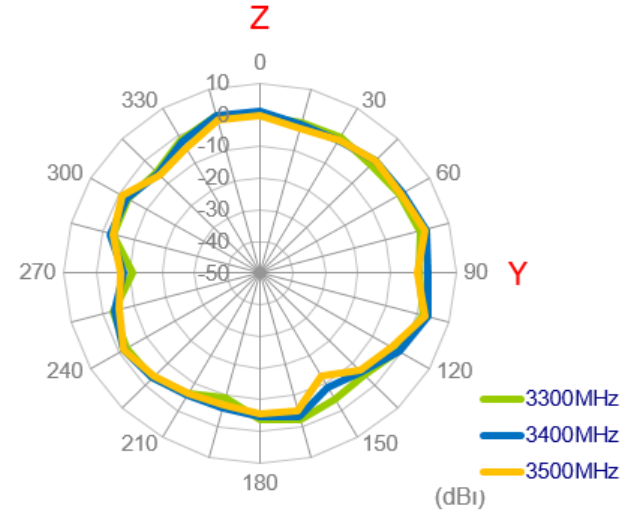
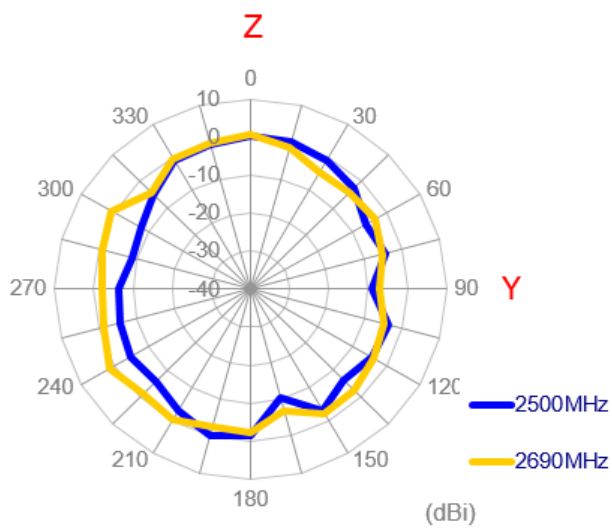
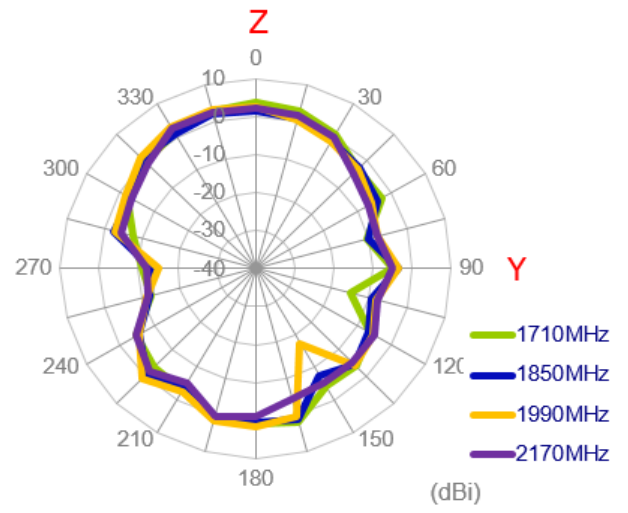
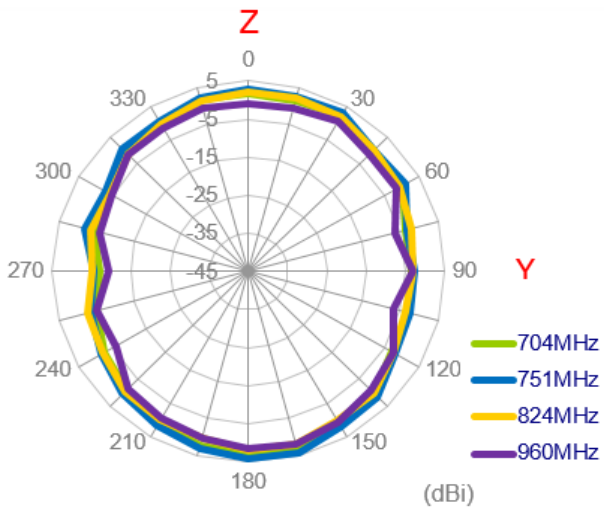

3.2.4 3D Radiation Patterns (LTE_MIMO2 with 1M cable length in free space)

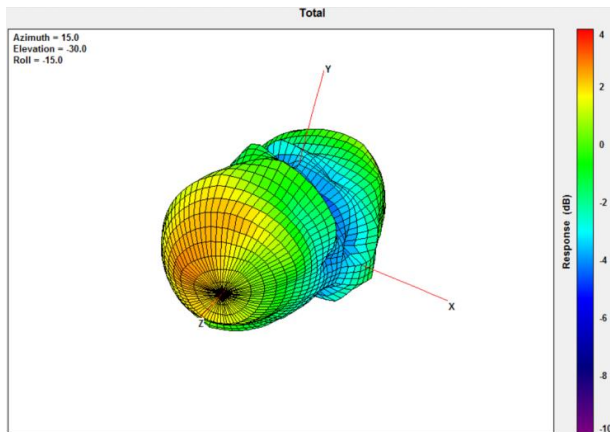

704MHz

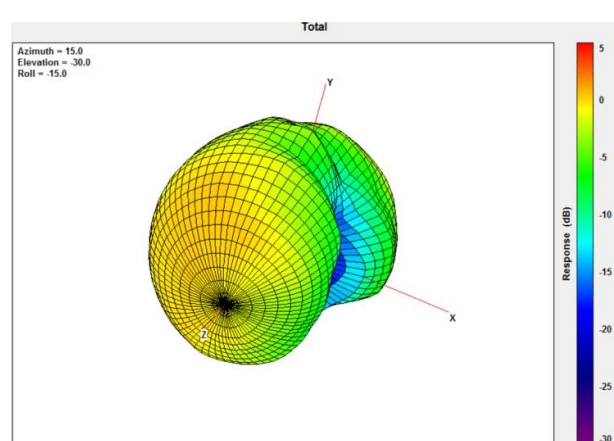

960MHz

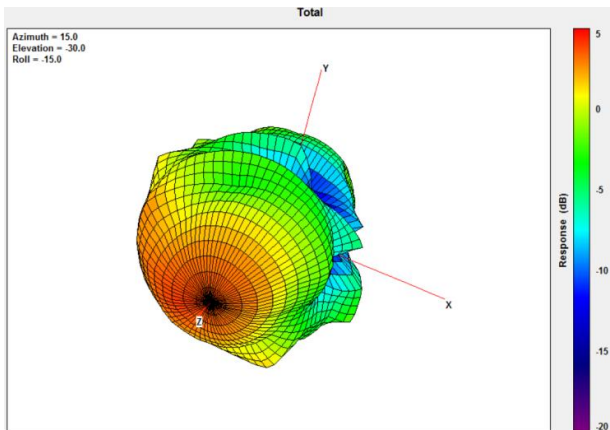

1710MHz

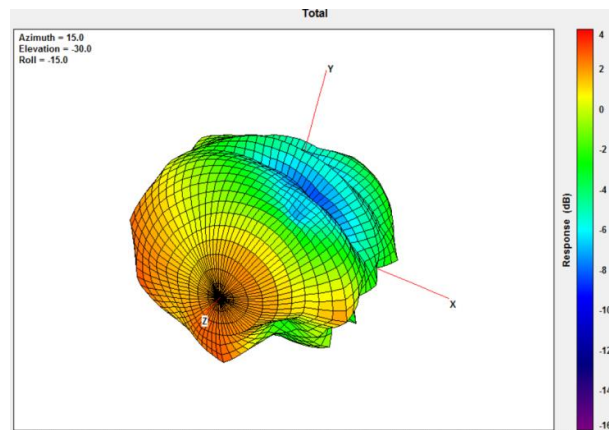

2170MHz

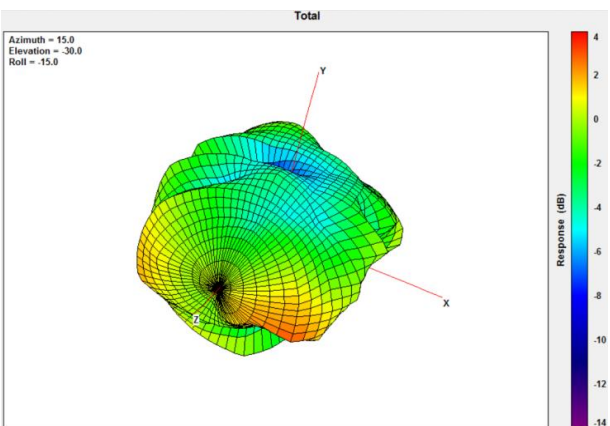

2690MHz

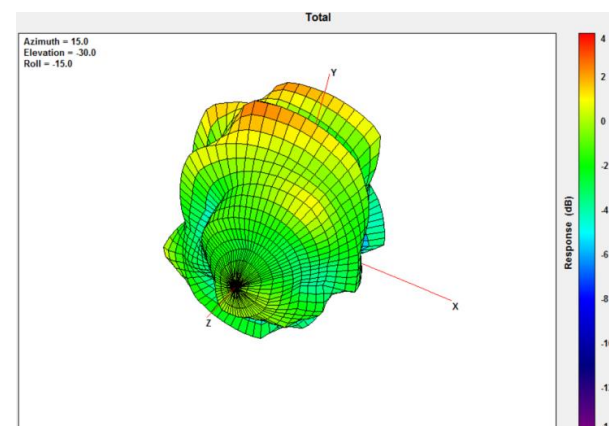

3500MHz

3.2.5 2D Radiation Patterns (LTE_MIMO1 with 3M cable length in free space)

XY Plane

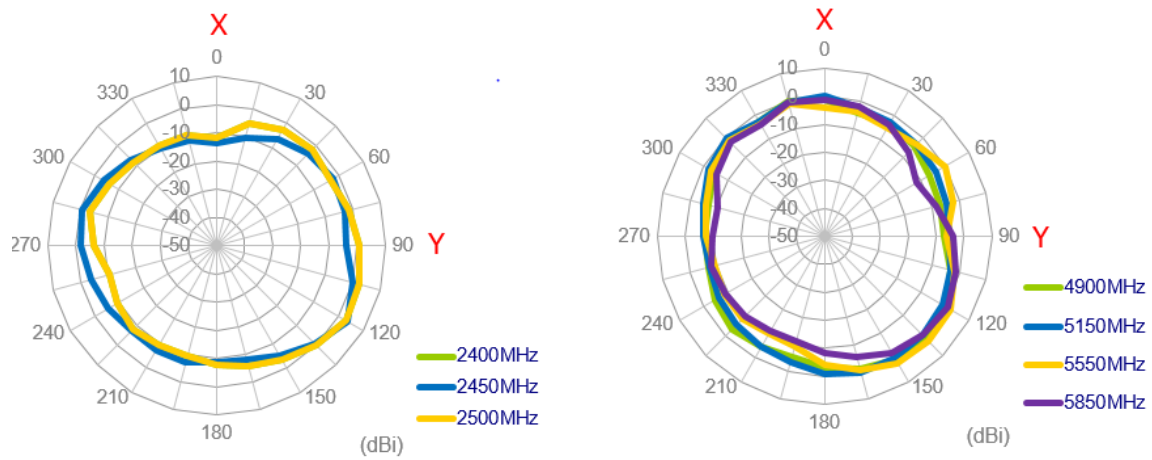

XZ Plane

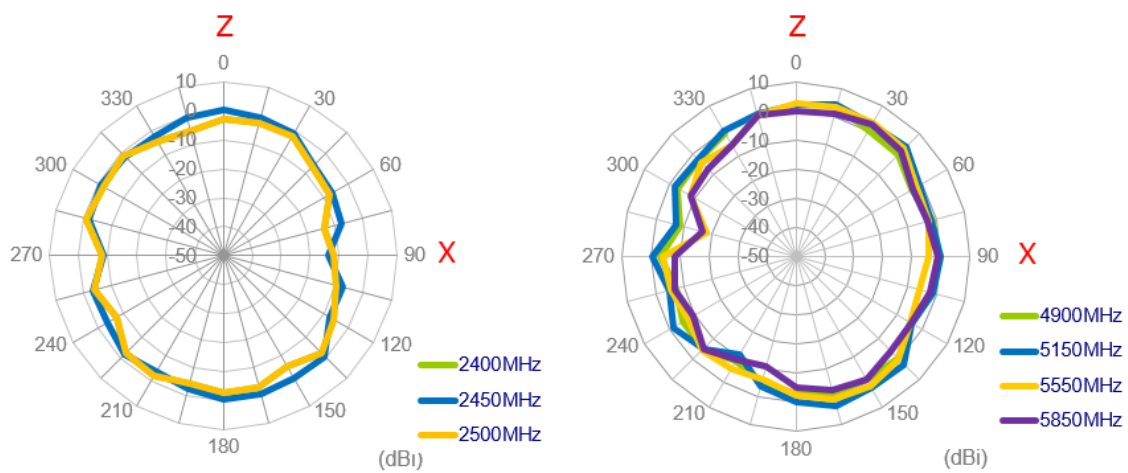

YZ Plane

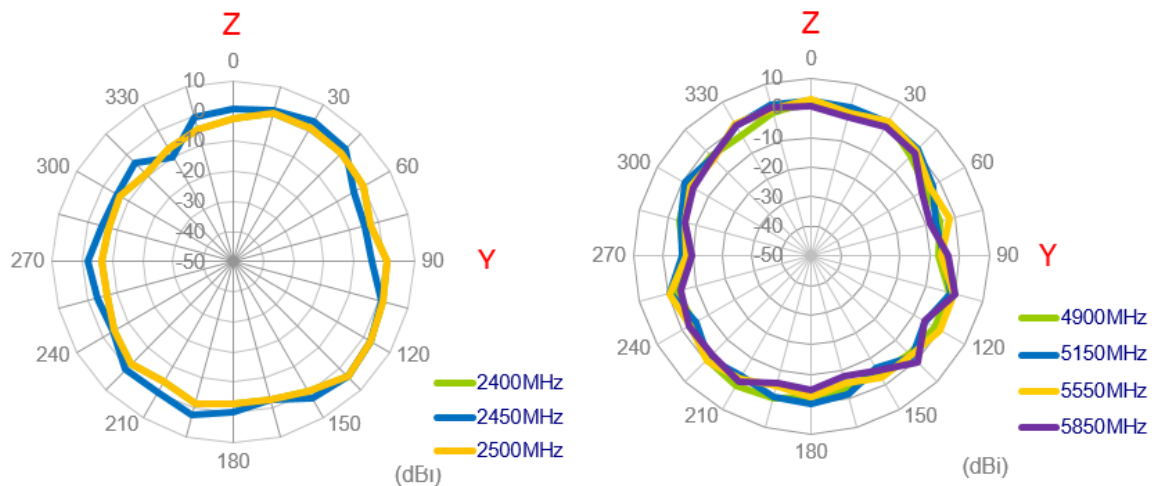

3.2.6 3D Radiation Patterns Pattern (Wi-Fi_MIMO1 with 3M cable length in free space)

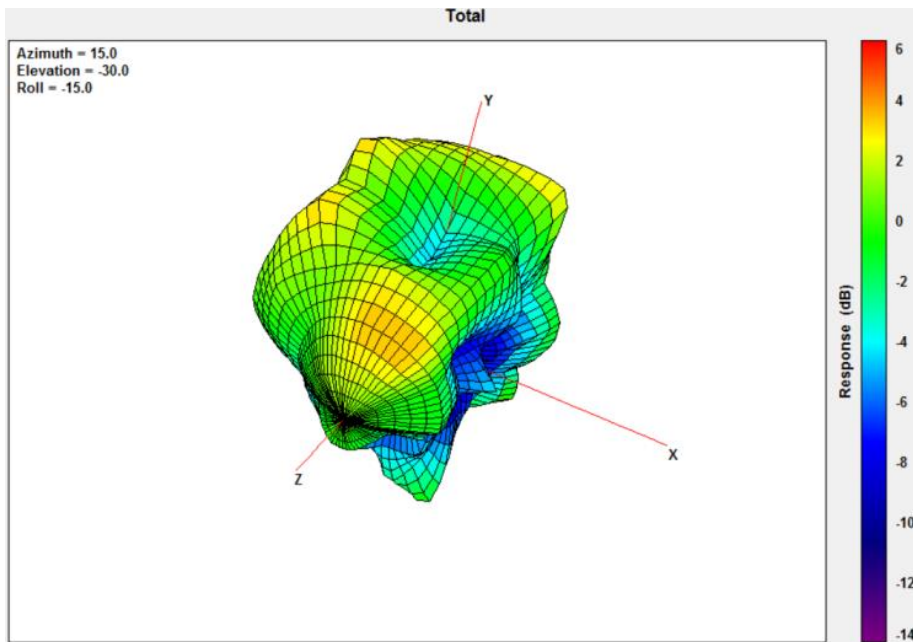

2450MHz

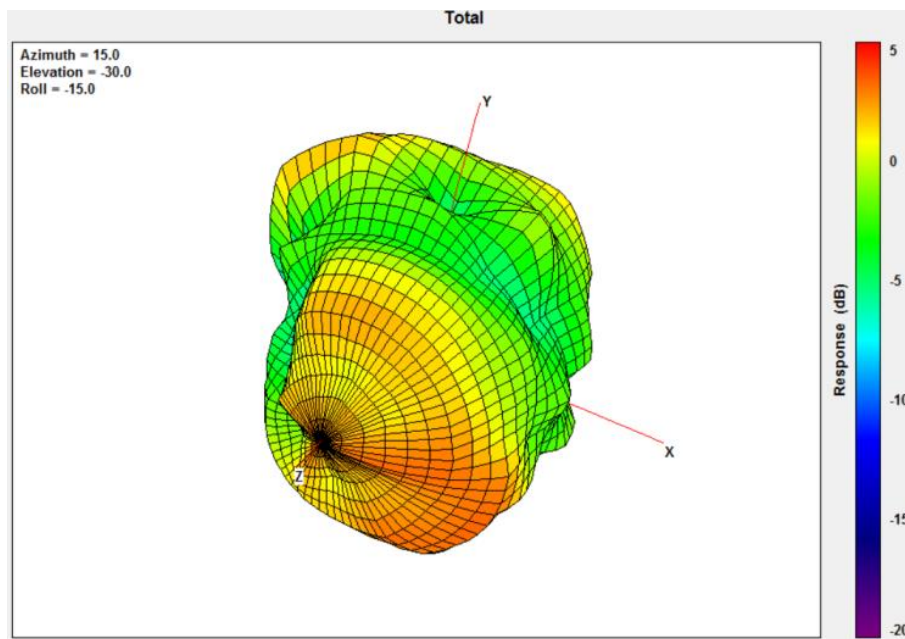

5550MHz

3.2.7 2D Radiation Patterns (Wi-Fi_MIMO2 with 3M cable length in free space)

XY Plane

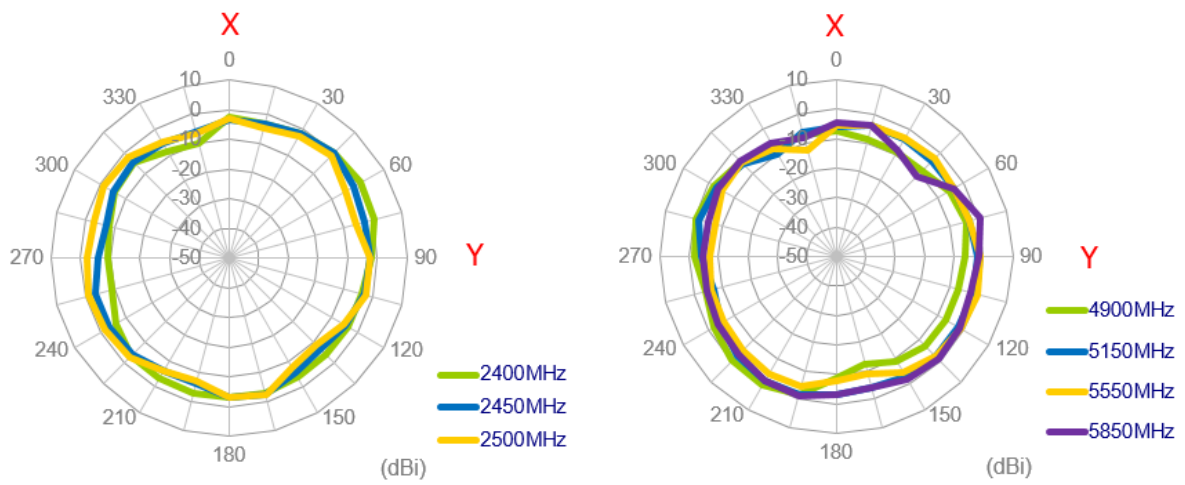

XZ Plane

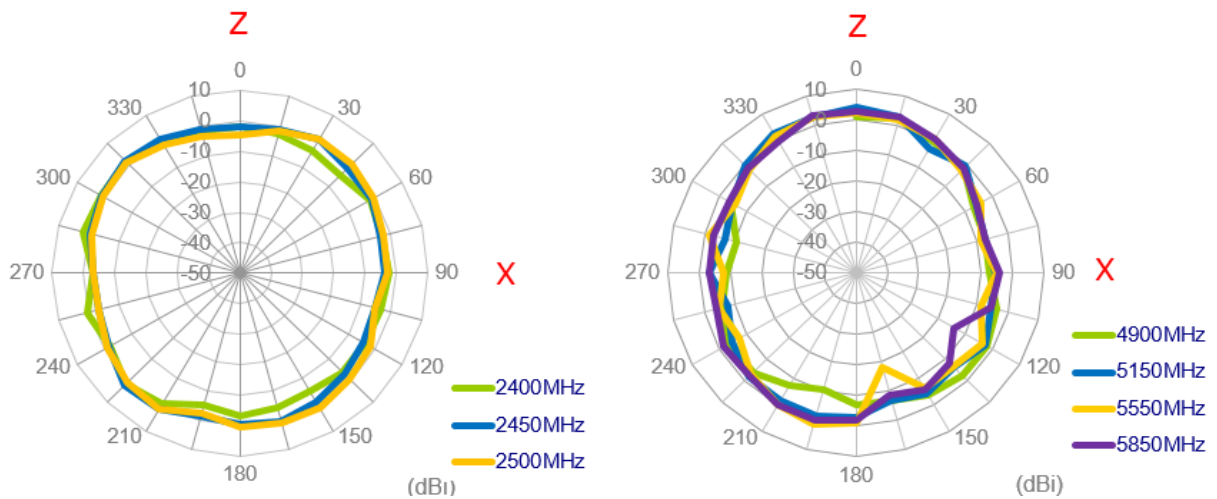

YZ Plane

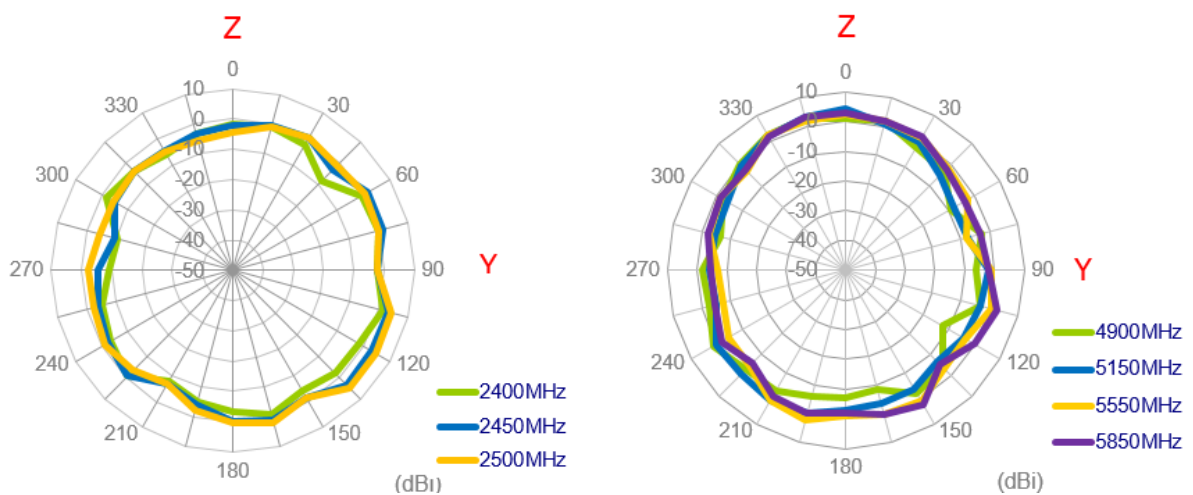

3.2.8 3D Radiation Patterns Pattern (Wi-Fi_MIMO2 with 3M cable length in free space)

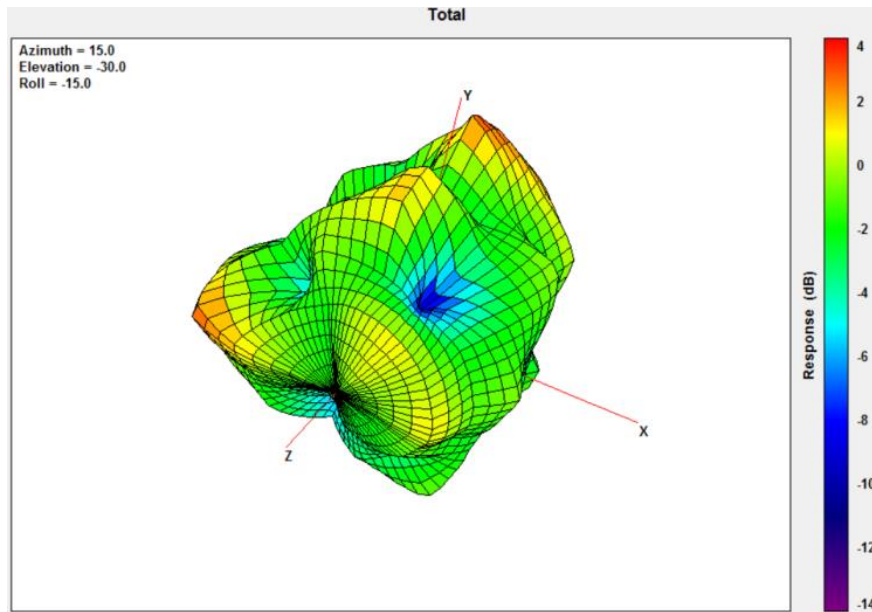

2450MHz

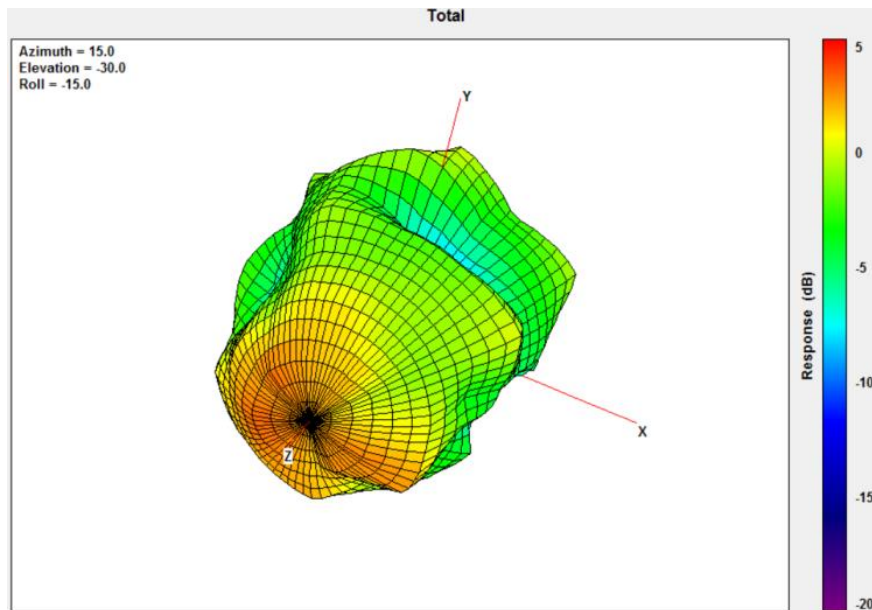

5550MHz

4. Mechanical Drawing (Units: mm)

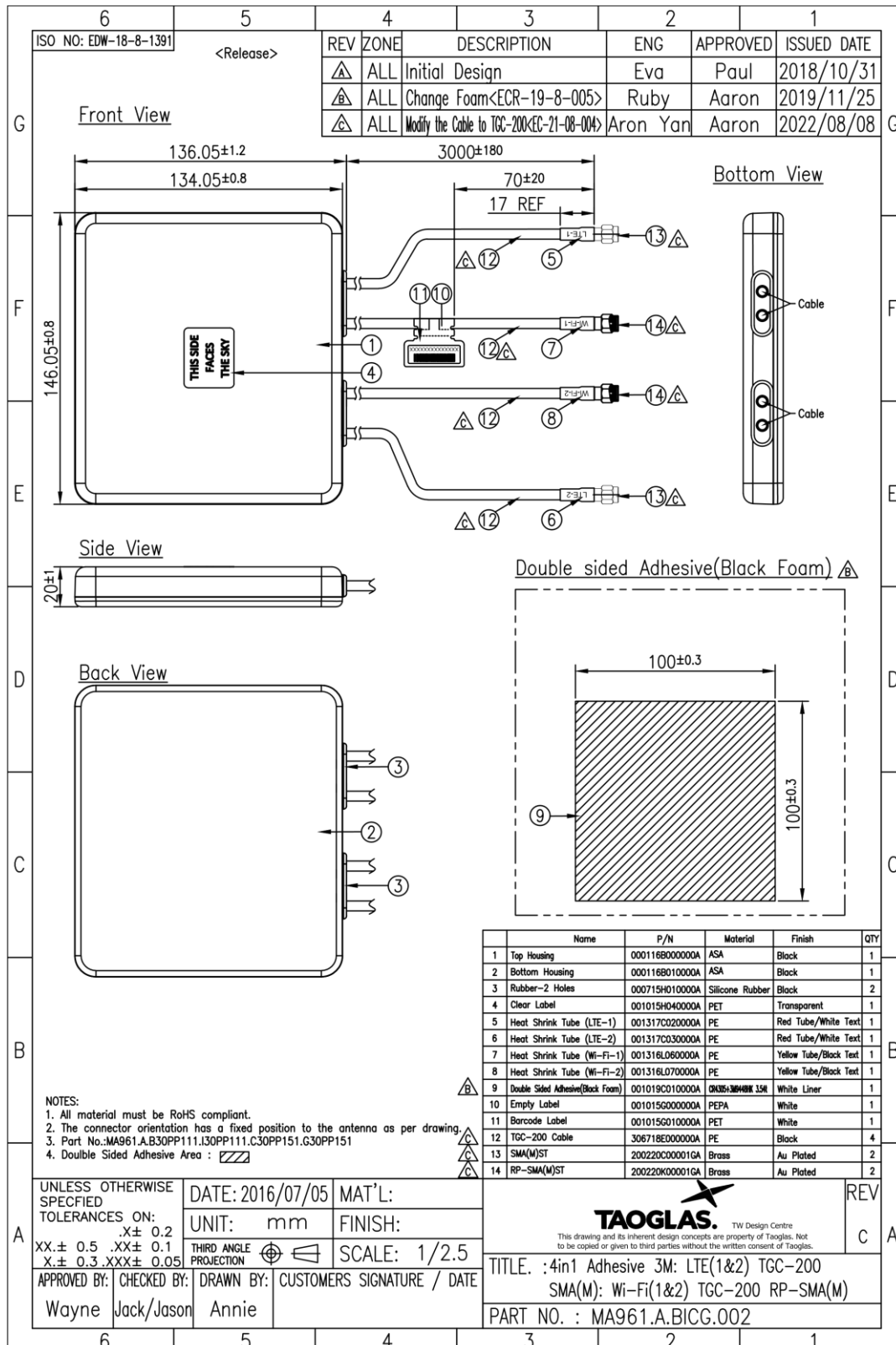

5. Packaging

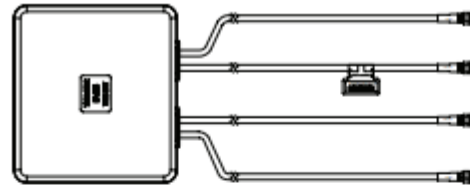

1 MA961.A.BICG.002 per small box
 Box Dimensions - 260 x 240 x 100mm
 Weight - 0.96g

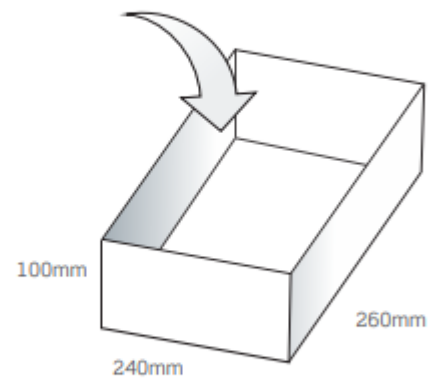

1 Outer Carton
 Carton Dimensions - 540 x 490 x 240mm
 8 pcs MA961.A.BICG.002 per carton
 Weight - 8.7Kg

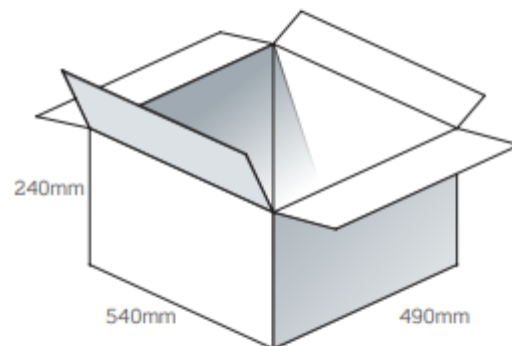

Pallet Dimensions 1200*1000*1400mm
 20 Cartons per Pallet
 4 Cartons per layer
 5 Layers

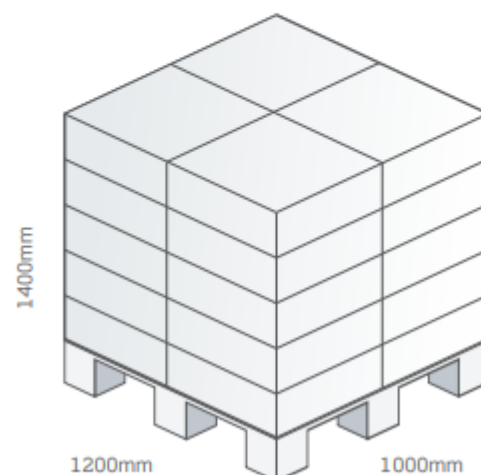

Changelog for the datasheet

SPE-17-8-048 – MA961.A.BICG.002

Revision: C (Current Versions)

Date:	2022-08-08
Notes:	Updated Drawing and specifications
Author:	Cesar Sousa

Previous Revisions

Revision: B

Date:	2019-02-26
Notes:	Updated Drawing
Author:	Jack Conroy

Revision: A (Original First Release)

Date:	2017-04-16
Notes:	Initial Datasheet Release
Author:	Author



www.taoglas.com

