



TAOGLAS®



Datasheet

Guardian 4in1 Wall Mount Antenna

Part No:
MA961.A.BICG.002.wm

Description:

Guardian 4in1 Wall Mount Antenna 2*LTE MIMO and 2*Wi-Fi MIMO

Features:

- Low-profile Housing
- Mount on Wall or Glass
- 2* 4G/LTE MIMO 698-4000MHz
- 2* Wi-Fi MIMO 2.4GHz/5.8GHz
- Worldwide 4G Bands including fallback to 3G and 2G
- IP67 Waterproof Enclosure
- Dims: 146*134*20mm
- Cables: 3M Low Loss TGC-200 and RG174
- Connectors: SMA(M)/RP-SMA(M)
- Cables and Connectors Customizable
- RoHS & REACH Compliant

| | | |
|----|---------------------------|----|
| 1. | Introduction | 3 |
| 2. | Specifications | 4 |
| 3. | Antenna Characteristics | 8 |
| 4. | Mechanical Drawing | 26 |
| 6. | Packaging | 27 |
| 7 | Application Note | 28 |
| 8. | Installation Instructions | 37 |
| | Changelog | |

Taoglas makes no warranties based on the accuracy or completeness of the contents of this document and reserves the right to make changes to specifications and product descriptions at any time without notice. Taoglas reserves all rights to this document and the information contained herein.

Reproduction, use or disclosure to third parties without express permission is strictly prohibited.



1. Introduction



The MA961 Guardian is a next generation combination antenna. The first panel antenna worldwide designed for IoT Gateway and Router devices. It is a low profile 4in1 wall mount antenna. This unique product delivers powerful worldwide 4G LTE MIMO antenna technology at 698-4000MHz bands and dual band Wi-Fi. It is a heavy-duty, fully IP67 waterproof external M2M antenna for use by RF professionals in IoT Gateway and Routers, HD Video Streaming, Transportation and Remote Monitoring Applications.

This antenna delivers powerful MIMO antenna technology for worldwide 4G LTE bands at 698-4000MHz bands and dual 2.4/5.8GHz Wi-Fi. It enables designers to cover a wide range of technologies by installing a single antenna.

4G wireless applications demand high speed data uplink and downlink. High efficiency and high gain MIMO antennas are necessary to achieve the required signal to noise ratio and throughput required to solve these challenges. Taoglas also takes care to have high isolation among these antennas to prevent self-interference. Low loss cables used to keep efficiency high over long cable lengths.

The housing is made of durable ASA, is IP67 waterproof and comes with a wall mount. The antenna can be mounted internally or externally on a vehicle or building. The MA961 comes with 3 meters TGC-200 cable as standard. Customized cables and connector versions are also available. Contact your regional Taoglas customer support for more information on how to integrate the MA961 or sales support.

2. Specifications

| 4G/3G/2G MIMO1 Antenna | | | | | | | | | |
|------------------------|---------|---|---------|-----------|-----------|-----------|-----------|-----------|-------|
| Frequency (MHz) | LTE700 | GSM850 | GSM900 | DCS | PCS | UMTS1 | LTE2600 | LTE3500 | |
| | 698~803 | 824~894 | 880~960 | 1710~1880 | 1850~1990 | 1920~2170 | 2490~2690 | 3300~3600 | |
| Efficiency (%) | | | | | | | | | |
| In free space | 30cm | 80.59 | 64.37 | 61.48 | 67.87 | 72.91 | 76.16 | 47.65 | 55.23 |
| | 1M | 76.15 | 61.48 | 58.71 | 61.90 | 66.50 | 70.02 | 43.45 | 49.00 |
| | 2M | 71.06 | 56.46 | 53.55 | 55.17 | 58.52 | 61.35 | 37.52 | 41.47 |
| | 3M | 65.87 | 52.33 | 49.65 | 49.03 | 51.74 | 54.25 | 32.54 | 35.03 |
| | 5M | 56.97 | 44.54 | 41.98 | 38.65 | 40.59 | 42.27 | 24.39 | 25.12 |
| Average Gain (dB) | | | | | | | | | |
| In free space | 30cm | -0.95 | -1.92 | -2.11 | -1.69 | -1.37 | -1.19 | -3.42 | -2.64 |
| | 1M | -1.19 | -2.12 | -2.31 | -2.09 | -1.77 | -1.55 | -3.82 | -3.17 |
| | 2M | -1.49 | -2.49 | -2.71 | -2.59 | -2.33 | -2.13 | -4.45 | -3.89 |
| | 3M | -1.82 | -2.82 | -3.04 | -3.10 | -2.86 | -2.66 | -5.08 | -4.62 |
| | 5M | -2.45 | -3.52 | -3.77 | -4.13 | -3.92 | -3.75 | -6.33 | -6.07 |
| Peak Gain (dBi) | | | | | | | | | |
| In free space | 30cm | 3.83 | 3.32 | 1.83 | 4.23 | 4.23 | 4.70 | 4.11 | 3.36 |
| | 1M | 3.63 | 3.12 | 1.63 | 3.83 | 3.83 | 4.30 | 3.71 | 3.36 |
| | 2M | 3.33 | 2.82 | 1.23 | 3.33 | 3.33 | 3.80 | 3.11 | 2.66 |
| | 3M | 3.03 | 2.42 | 0.85 | 2.73 | 2.73 | 3.20 | 2.51 | 1.86 |
| | 5M | 2.33 | 1.72 | 0.15 | 1.73 | 1.73 | 2.10 | 1.31 | 0.46 |
| 4G/3G/2G MIMO2 Antenna | | | | | | | | | |
| Efficiency (%) | | | | | | | | | |
| In free space | 30cm | 80.00 | 63.77 | 59.51 | 67.36 | 72.20 | 76.03 | 57.82 | 64.24 |
| | 1M | 75.66 | 60.90 | 56.84 | 61.43 | 65.84 | 69.92 | 52.74 | 56.94 |
| | 2M | 70.61 | 55.93 | 51.83 | 54.75 | 57.94 | 61.24 | 45.51 | 48.21 |
| | 3M | 65.44 | 51.84 | 48.09 | 48.66 | 51.23 | 54.16 | 39.45 | 40.77 |
| | 5M | 56.55 | 44.12 | 40.66 | 38.36 | 40.18 | 42.20 | 29.58 | 29.22 |
| Average Gain (dB) | | | | | | | | | |
| In free space | 30cm | -0.99 | -1.96 | -2.26 | -1.72 | -1.42 | -1.20 | -2.47 | -1.93 |
| | 1M | -1.23 | -2.16 | -2.46 | -2.12 | -1.82 | -1.56 | -2.87 | -2.46 |
| | 2M | -1.53 | -2.53 | -2.86 | -2.62 | -2.37 | -2.14 | -3.50 | -3.18 |
| | 3M | -1.86 | -2.86 | -3.19 | -3.13 | -2.91 | -2.67 | -4.13 | -3.91 |
| | 5M | -2.49 | -3.56 | -3.92 | -4.16 | -3.96 | -3.76 | -5.38 | -5.36 |
| Peak Gain (dBi) | | | | | | | | | |
| In free space | 30cm | 4.86 | 3.06 | 2.81 | 4.41 | 4.67 | 4.56 | 3.95 | 4.15 |
| | 1M | 4.66 | 2.86 | 2.61 | 4.01 | 4.27 | 4.19 | 3.55 | 3.55 |
| | 2M | 4.36 | 2.56 | 2.21 | 3.51 | 3.77 | 3.66 | 2.95 | 2.85 |
| | 3M | 4.06 | 2.16 | 1.91 | 2.99 | 3.17 | 3.06 | 2.35 | 2.15 |
| | 5M | 3.36 | 1.46 | 1.21 | 1.99 | 2.17 | 2.06 | 1.15 | 0.65 |
| Impedance | | 50Ω | | | | | | | |
| Polarization | | Linear | | | | | | | |
| VSWR | | < 3 | | | | | | | |
| Cable | | 3 meters TGC-200 standard, fully customizable | | | | | | | |
| Connector | | SMA(M) standard, fully customizable | | | | | | | |

| ELECTRICAL | | | |
|---------------------------|--|-----------|-----------|
| Frequency (MHz) | | 2400~2500 | 4900~5850 |
| Efficiency (%) | | | |
| MIMO_1 | 30cm | 69.77 | 59.81 |
| | 1M | 63.63 | 51.43 |
| | 2M | 55.42 | 41.67 |
| | 3M | 48.27 | 33.81 |
| | 5M | 36.62 | 22.18 |
| MIMO_2 | 30cm | 70.19 | 59.69 |
| | 1M | 64.01 | 51.32 |
| | 2M | 55.75 | 41.57 |
| | 3M | 48.56 | 33.71 |
| | 5M | 36.84 | 22.12 |
| Average Gain (dBi) | | | |
| MIMO_1 | 30cm | -1.57 | -2.27 |
| | 1M | -1.97 | -2.92 |
| | 2M | -2.57 | -3.84 |
| | 3M | -3.17 | -4.75 |
| | 5M | -4.37 | -6.58 |
| MIMO_2 | 30cm | -1.54 | -2.25 |
| | 1M | -1.94 | -2.91 |
| | 2M | -2.54 | -3.82 |
| | 3M | -3.14 | -4.73 |
| | 5M | -4.34 | -6.56 |
| Peak Gain (dBi) | | | |
| MIMO_1 | 30cm | 4.87 | 4.95 |
| | 1M | 4.37 | 4.26 |
| | 2M | 3.77 | 3.36 |
| | 3M | 3.17 | 2.46 |
| | 5M | 1.97 | 0.66 |
| MIMO_2 | 30cm | 4.93 | 5.09 |
| | 1M | 4.43 | 4.39 |
| | 2M | 3.83 | 3.49 |
| | 3M | 3.23 | 2.59 |
| | 5M | 2.03 | 0.79 |
| Impedance | 50Ω | | |
| Polarization | Linear | | |
| VSWR | < 3 | | |
| Cable | 3 meter TGC-200 standard, fully customizable | | |
| Connector | SMA(M) standard, fully customizable | | |

| MECHANICAL | |
|---------------------------|----------------------------|
| Antenna Dimensions | 146*134*20mm |
| Casing | ABS+PC |
| Base and thread | Nickel Plated Aluminium |
| Weight | 586g |
| Ingress Protection Rating | IP67 |
| ENVIRONMENTAL | |
| Operation Temperature | -40°C to 85°C |
| Storage Temperature | -40°C to 90°C |
| Humidity | Non-condensing 65°C 95% RH |

| LTE Bands | | | | |
|-------------|--|-------------------------------|--------|--------|
| Band Number | LTE / LTE-Advanced / WCDMA / HSPA / HSPA+ / TD-SCDMA | | | |
| | Uplink | Downlink | MIMO 1 | MIMO 2 |
| 1 | UL: 1920 to 1980 | DL: 2110 to 2170 | ✓ | ✓ |
| 2 | UL: 1850 to 1910 | DL: 1930 to 1990 | ✓ | ✓ |
| 3 | UL: 1710 to 1785 | DL: 1805 to 1880 | ✓ | ✓ |
| 4 | UL: 1710 to 1755 | DL: 2110 to 2155 | ✓ | ✓ |
| 5 | UL: 824 to 849 | DL: 869 to 894 | ✓ | ✓ |
| 7 | UL: 2500 to 2570 | DL: 2620 to 2690 | ✓ | ✓ |
| 8 | UL: 880 to 915 | DL: 925 to 960 | ✓ | ✓ |
| 9 | UL: 1749.9 to 1784.9 | DL: 1844.9 to 1879.9 | ✓ | ✓ |
| 11 | UL: 1427.9 to 1447.9 | DL: 1475.9 to 1495.9 | ✗ | ✗ |
| 12 | UL: 699 to 716 | DL: 729 to 746 | ✓ | ✓ |
| 13 | UL: 777 to 787 | DL: 746 to 756 | ✓ | ✓ |
| 14 | UL: 788 to 798 | DL: 758 to 768 | ✓ | ✓ |
| 17 | UL: 704 to 716 | DL: 734 to 746 (LTE only) | ✓ | ✓ |
| 18 | UL: 815 to 830 | DL: 860 to 875 (LTE only) | ✓ | ✓ |
| 19 | UL: 830 to 845 | DL: 875 to 890 | ✓ | ✓ |
| 20 | UL: 832 to 862 | DL: 791 to 821 | ✓ | ✓ |
| 21 | UL: 1447.9 to 1462.9 | DL: 1495.9 to 1510.9 | ✗ | ✗ |
| 22 | UL: 3410 to 3490 | DL: 3510 to 3590 | ✓ | ✓ |
| 23 | UL: 2000 to 2020 | DL: 2180 to 2200 (LTE only) | ✓ | ✓ |
| 24 | UL: 1625.5 to 1660.5 | DL: 1525 to 1559 (LTE only) | ✓ | ✓ |
| 25 | UL: 1850 to 1915 | DL: 1930 to 1995 | ✓ | ✓ |
| 26 | UL: 814 to 849 | DL: 859 to 894 | ✓ | ✓ |
| 27 | UL: 807 to 824 | DL: 852 to 869 (LTE only) | ✓ | ✓ |
| 28 | UL: 703 to 748 | DL: 758 to 803 (LTE only) | ✓ | ✓ |
| 29 | UL: - | DL: 717 to 728 (LTE only) | ✓ | ✓ |
| 30 | UL: 2305 to 2315 | DL: 2350 to 2360 (LTE only) | ✓ | ✓ |
| 31 | UL: 452.5 to 457.5 | DL: 462.5 to 467.5 (LTE only) | ✗ | ✗ |
| 32 | UL: - | DL: 1452 - 1496 | ✓ | ✓ |
| 35 | | 1850 to 1910 | ✓ | ✓ |
| 38 | | 2570 to 2620 | ✗ | ✓ |
| 39 | | 1880 to 1920 | ✓ | ✓ |
| 40 | | 2300 to 2400 | ✓ | ✓ |
| 41 | | 2496 to 2690 | ✗ | ✓ |
| 42 | | 3400 to 3600 | ✓ | ✓ |
| 43 | | 3600 to 3800 | ✓ | ✓ |

*Covered bands represent greater than 20% efficiency

3. Antenna Characteristics

3.1 LTE_MIMO/Wi-Fi_MIMO Antenna

3.1.1 Test Setup

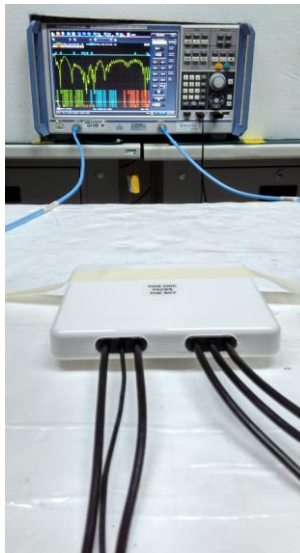

Free space

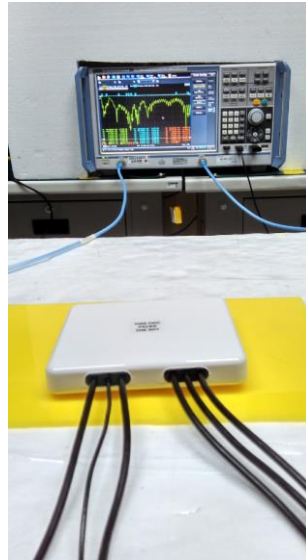

ABS

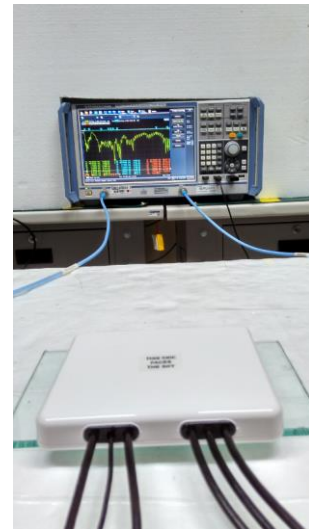

Glass

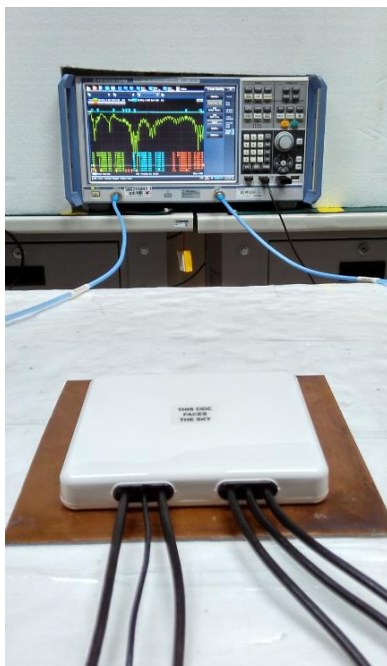

Metal

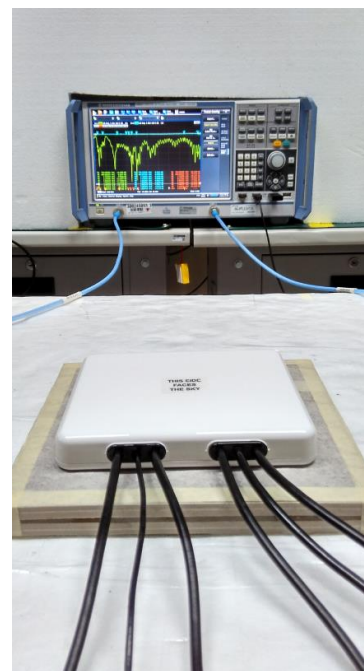

Wall

3.1.2 LTE_1 Antenna Return Loss

Performance in different environments with 1 meter cable length

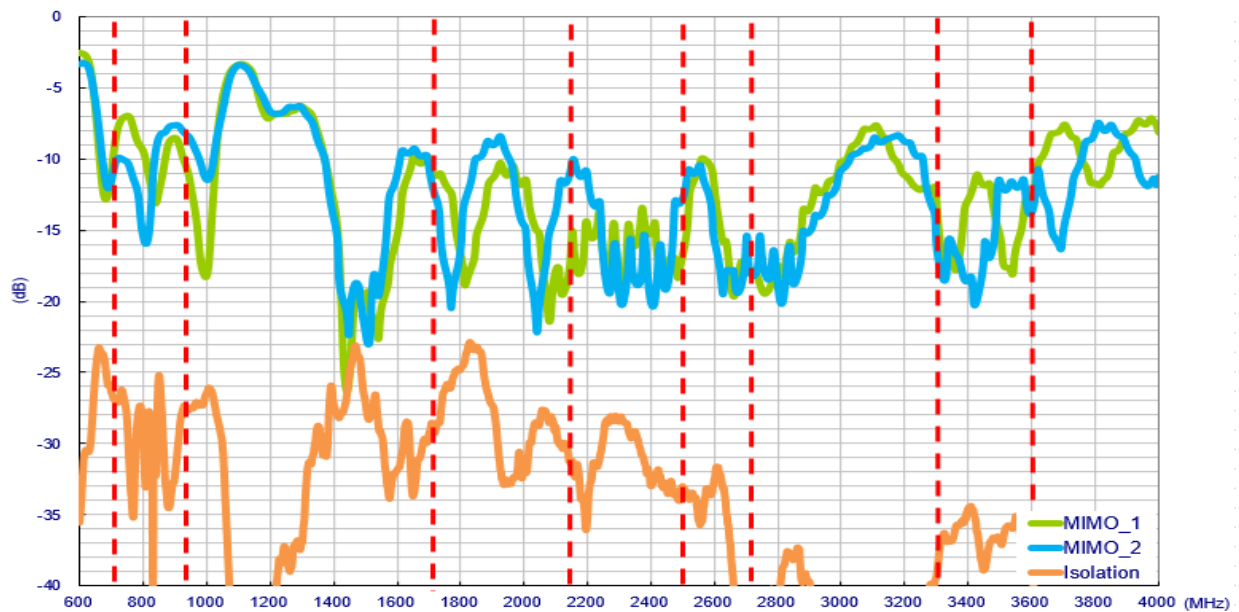

Figure 1. Return loss of MA961 LTE MIMO antenna in free space

3.1.3 LTE Antenna Efficiency

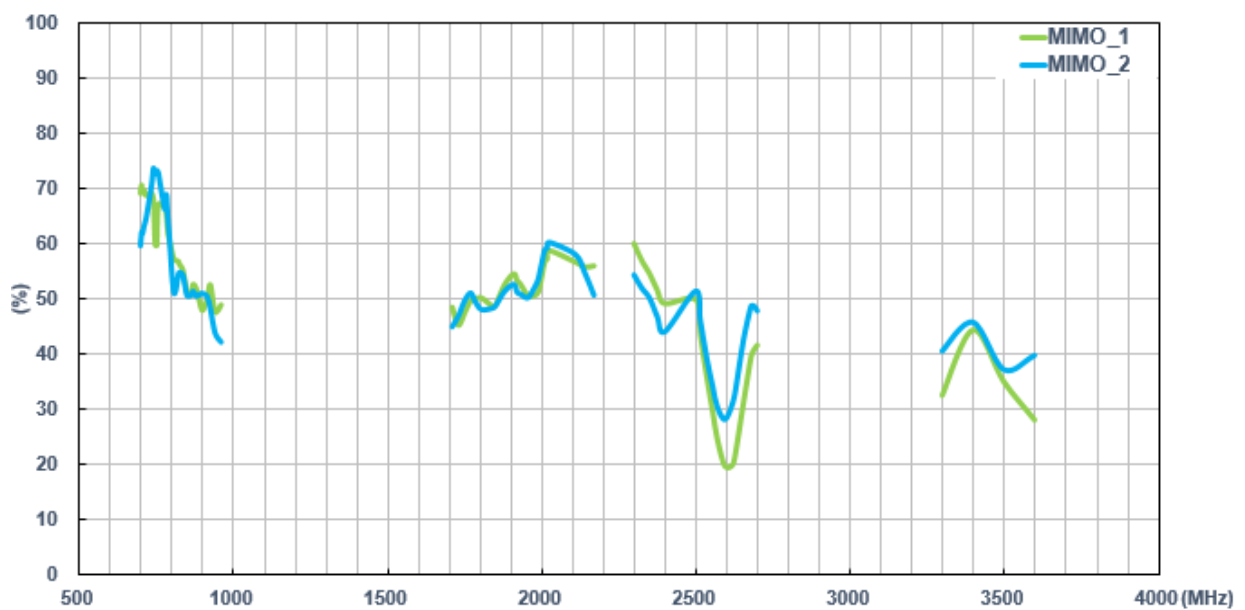

Figure 2. Efficiency of MA961 LTE MIMO antenna in free space

3.1.4 LTE Antenna Average Gain

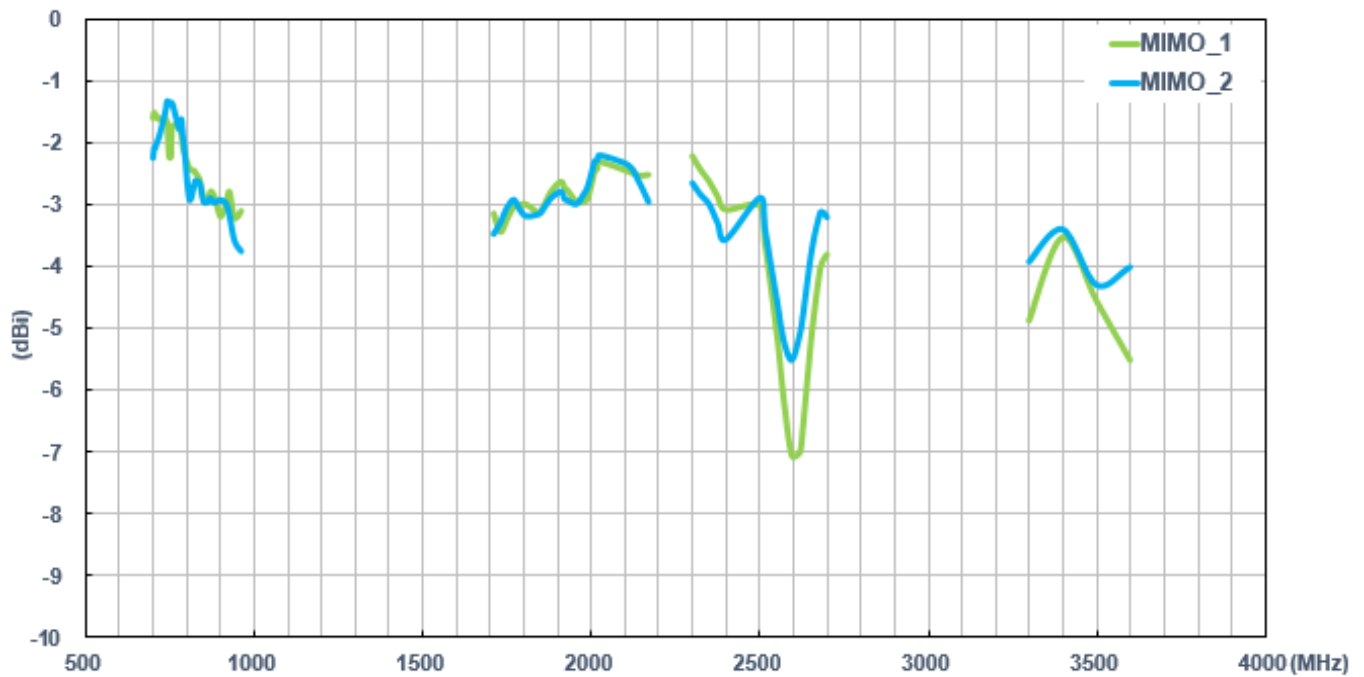

Figure 3. Average gain of MA961 LTE MIMO antenna in free space

3.1.5 LTE Antenna Peak Gain

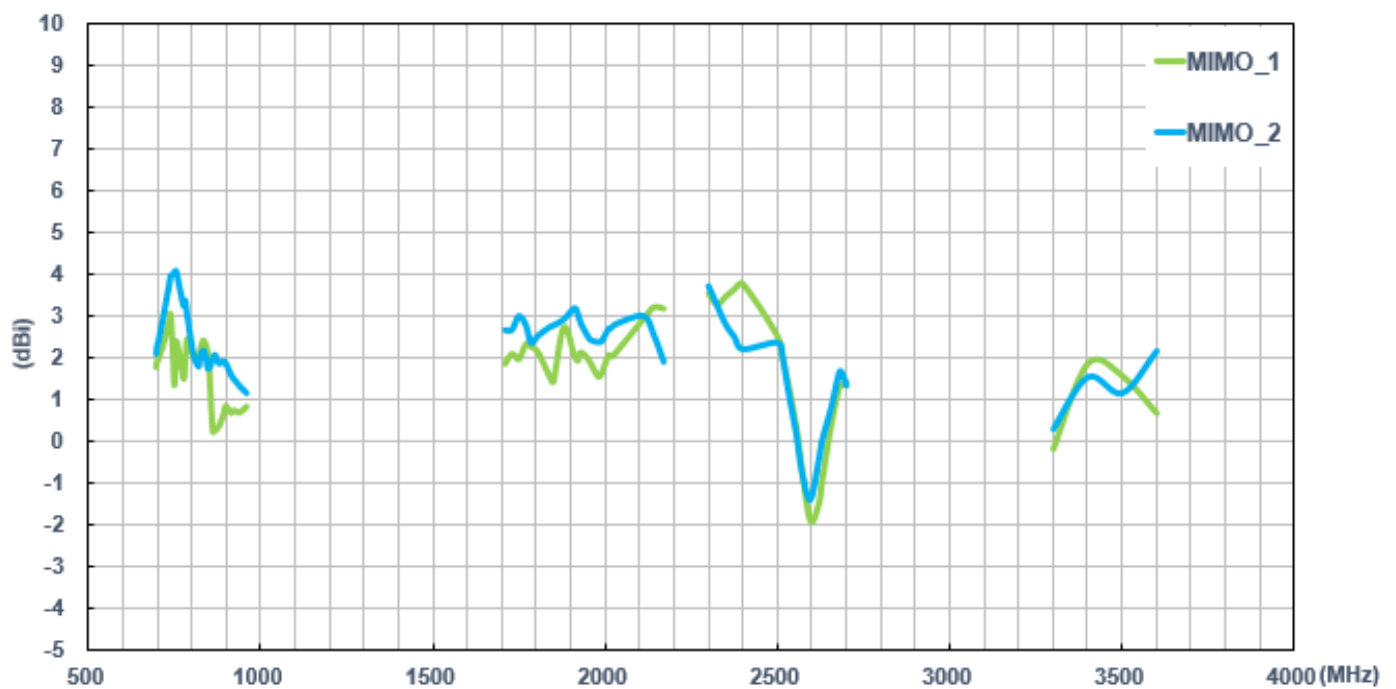

Figure 4. Peak gain of MA961 LTE MIMO antenna in the free space

3.2 Wi-Fi MIMO Antenna

3.2.1 Wi-Fi Antenna Return Loss and Isolation with 3-meter cable length

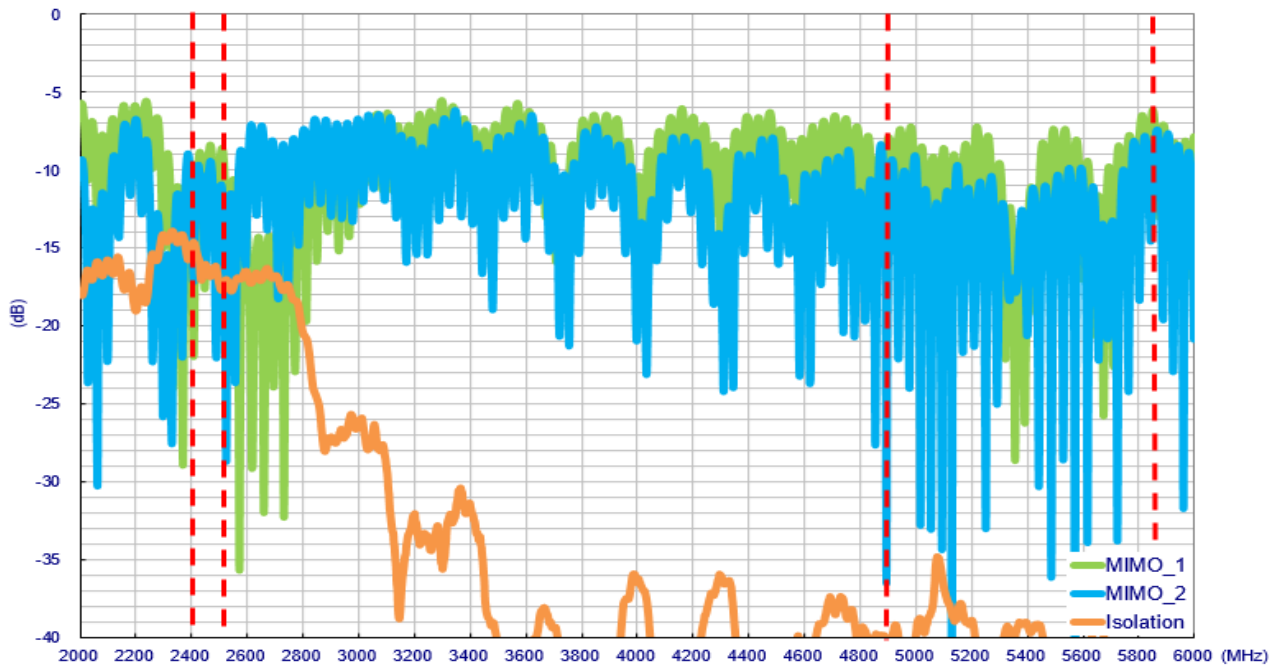

Figure 5. Return loss of MA961 Wi-Fi MIMO antenna in free space

3.2.2 Wi-Fi Antenna Efficiency

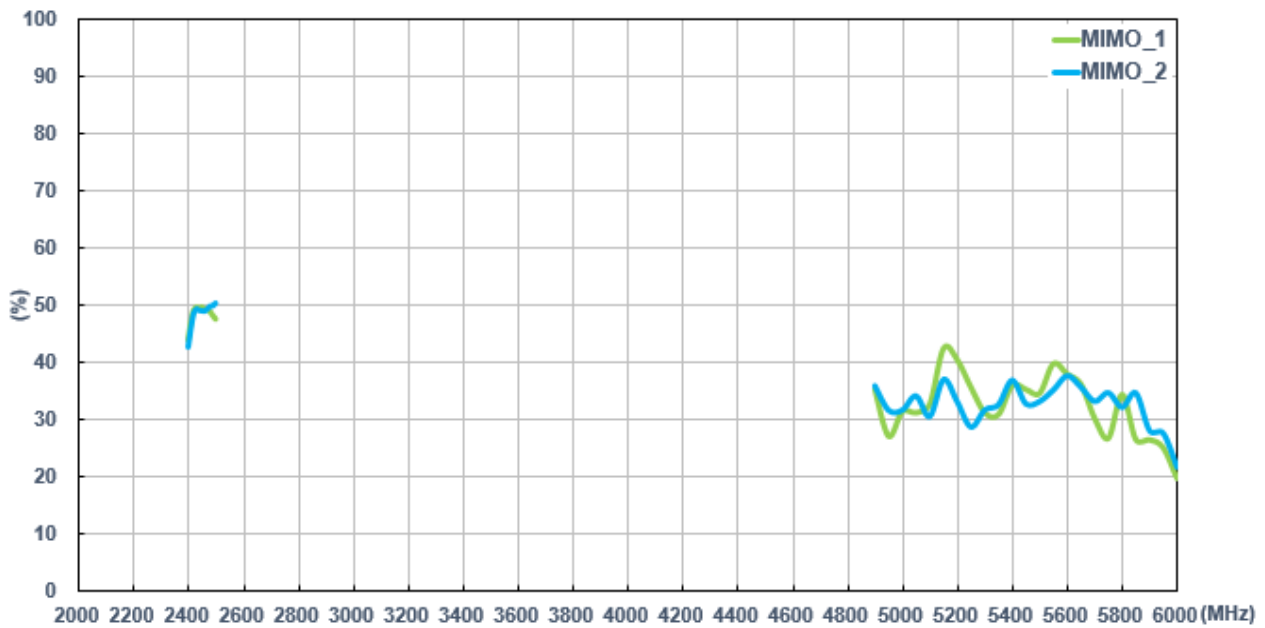

Figure 6. Efficiency of MA961 Wi-Fi MIMO antenna in free space

3.2.3 Wi-Fi Antenna Average Gain

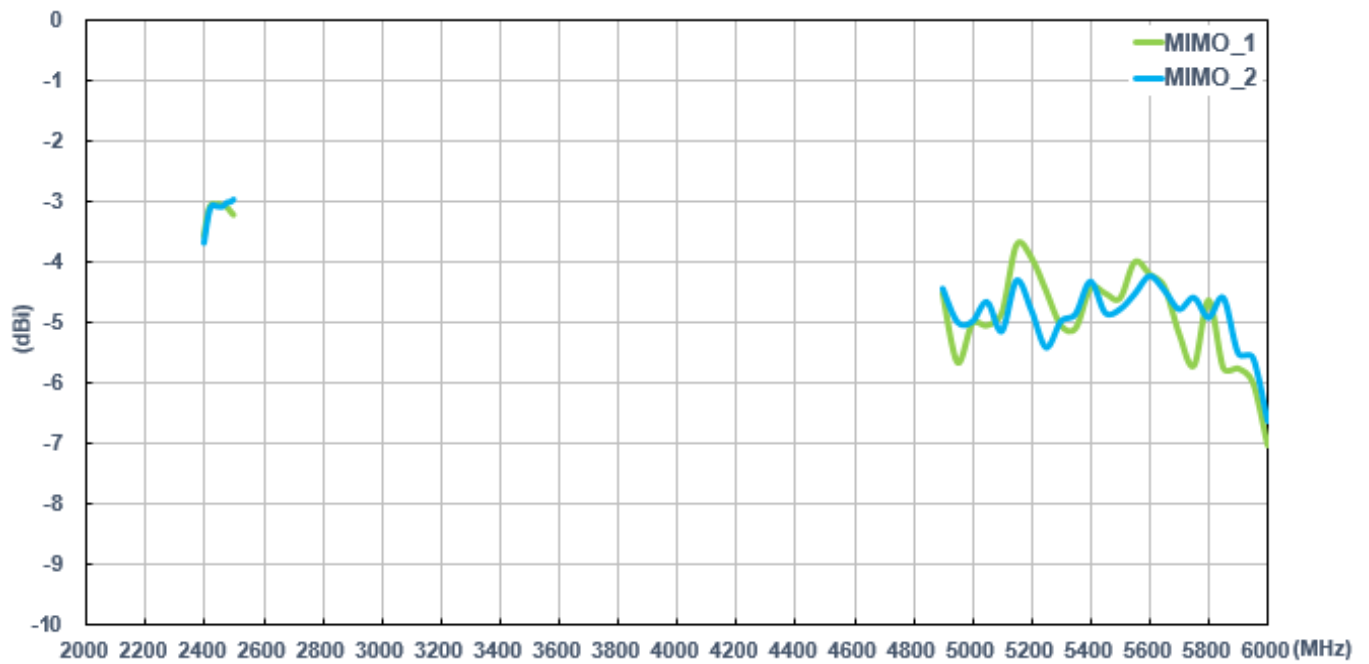

Figure 7. Average gain of MA961 Wi-Fi MIMO antenna in free space

3.2.4 Wi-Fi Antenna Peak Gain

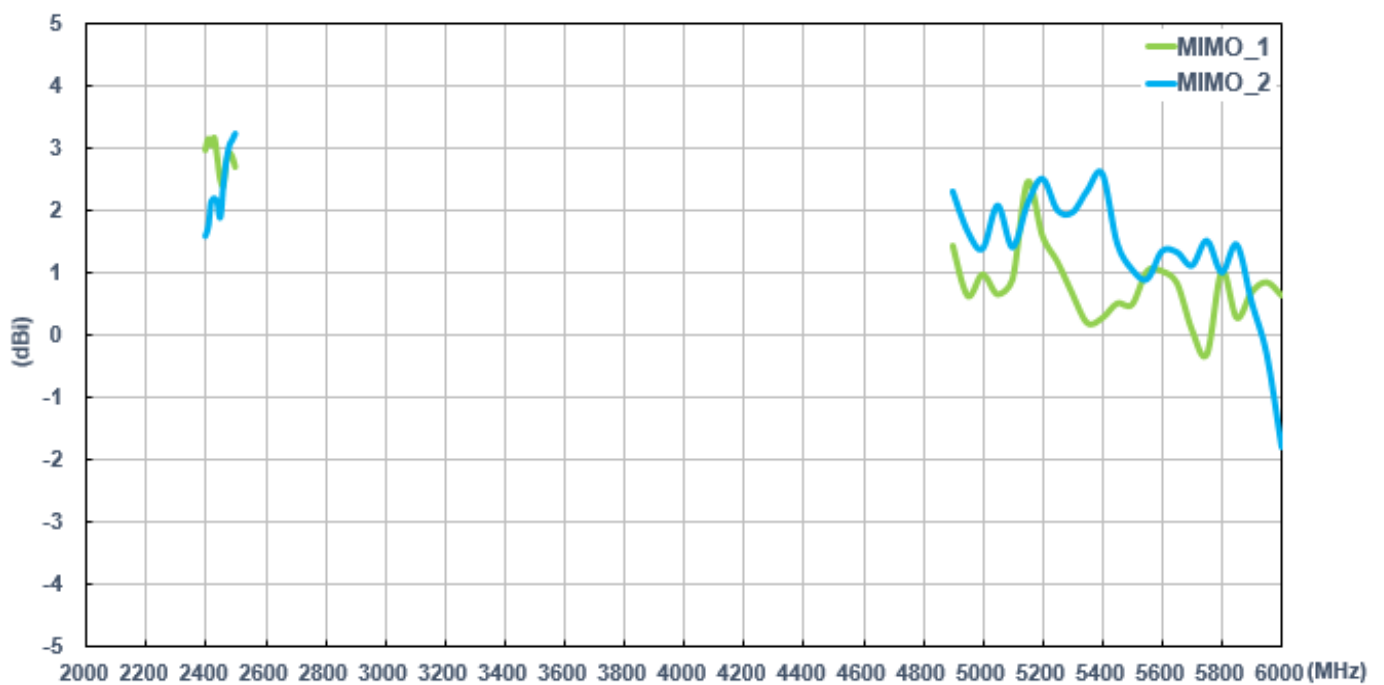

Figure 8. Peak gain of MA961 Wi-Fi MIMO antenna in the free space

3.3 Test Setup for Antenna Radiation Pattern (ETS Anechoic chamber)



Free space

3.3.1 2D Radiation Patterns (LTE_MIMO1 with 3M cable length in free space)

XY Plane

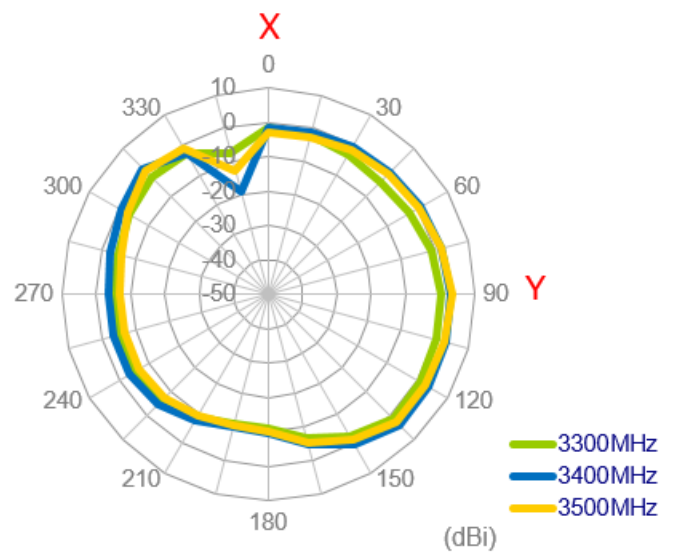
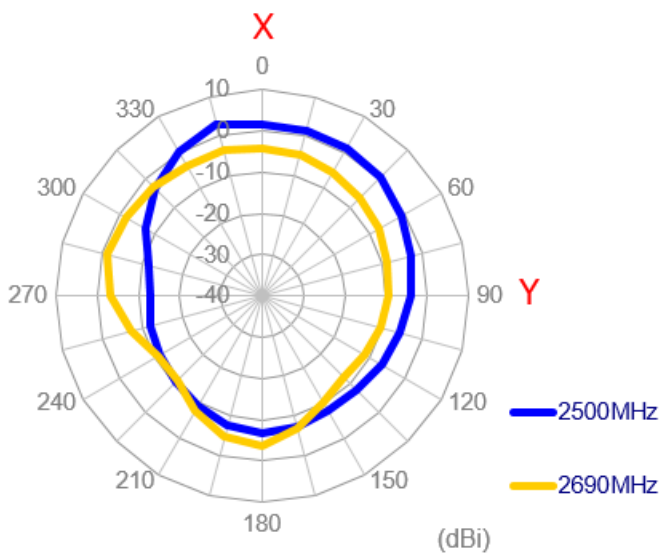
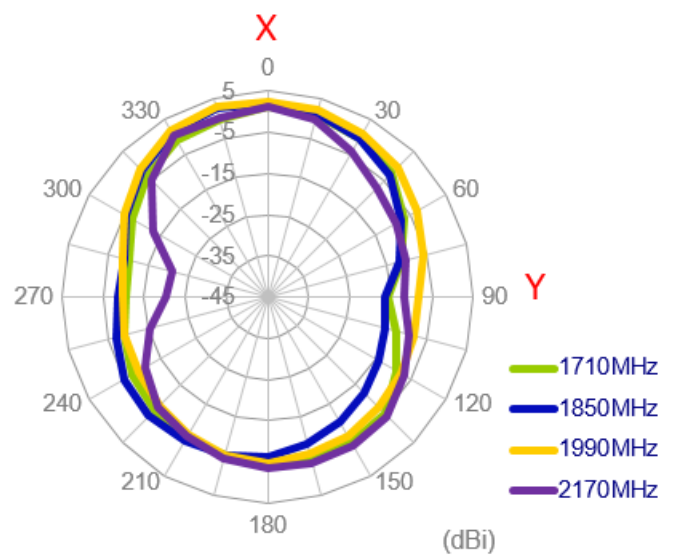
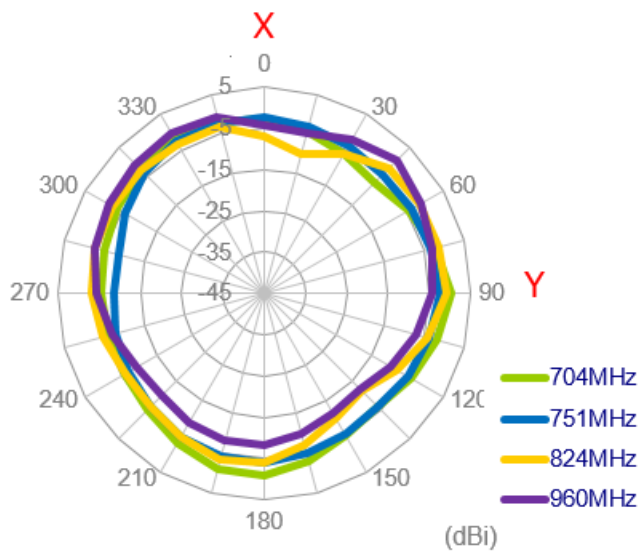

XZ Plane

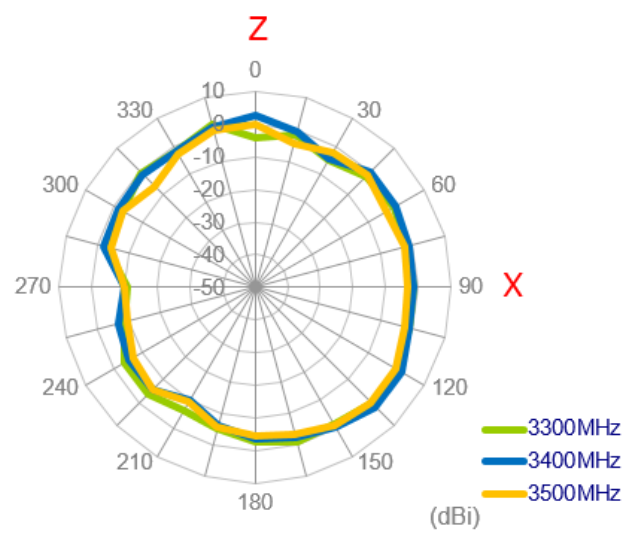
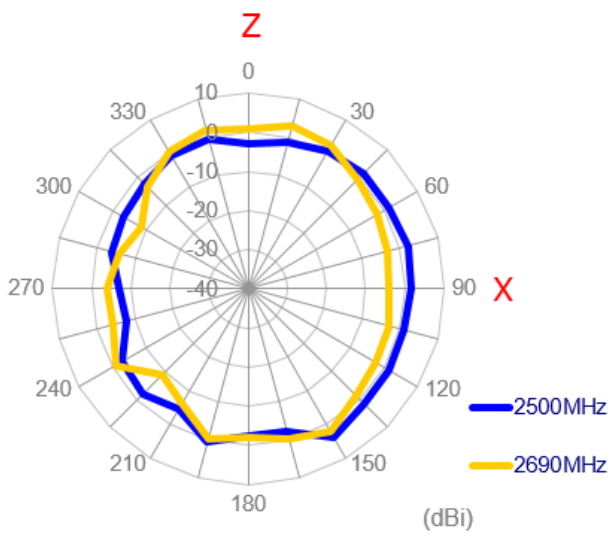
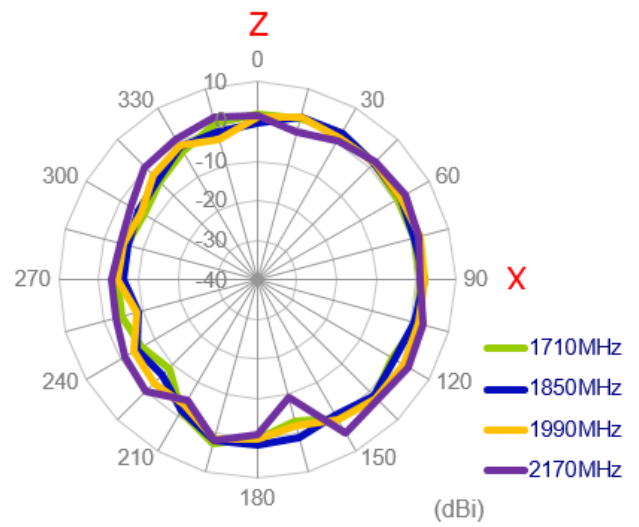
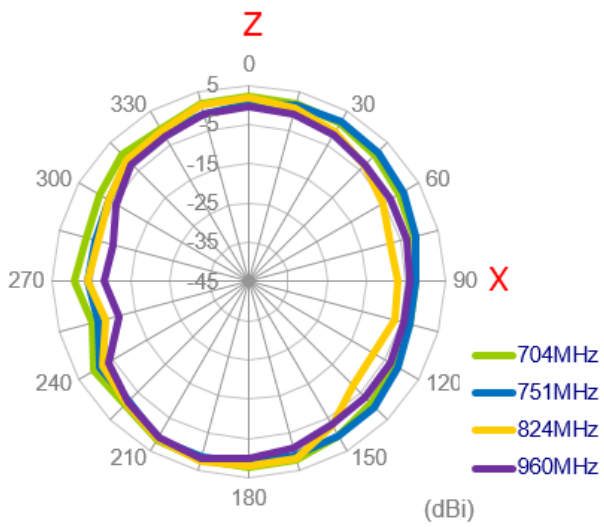

YZ Plane

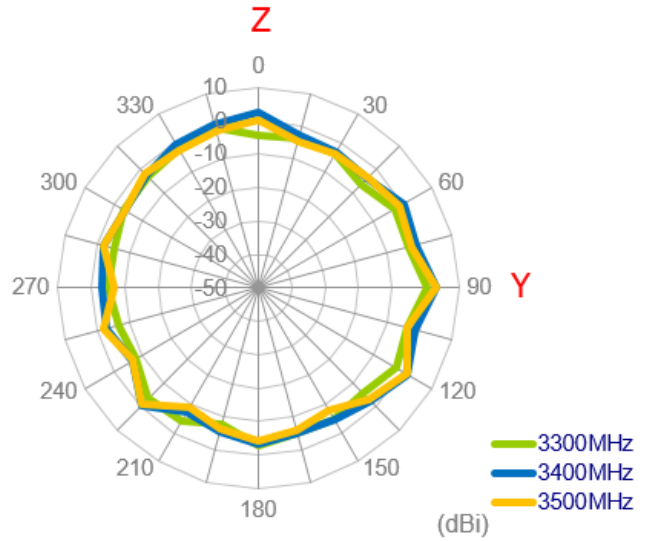
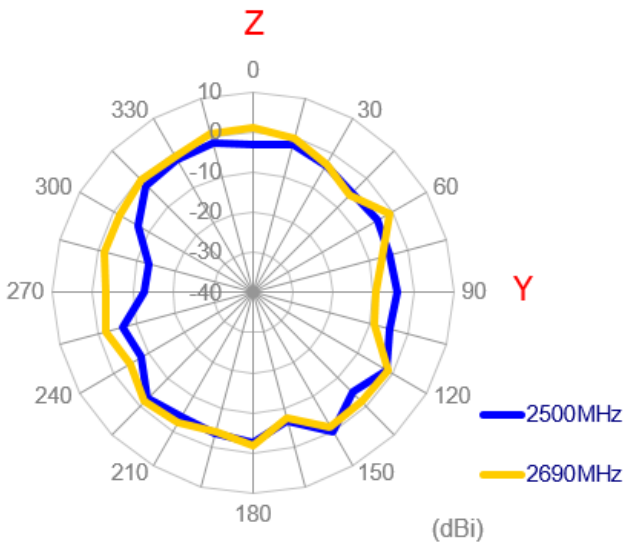
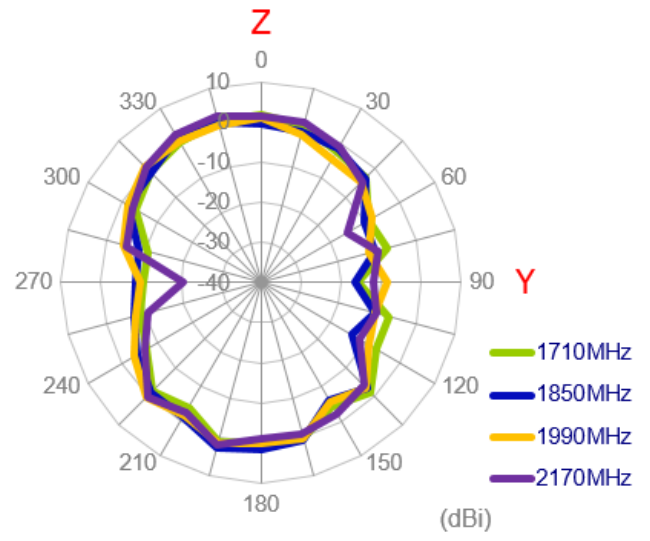
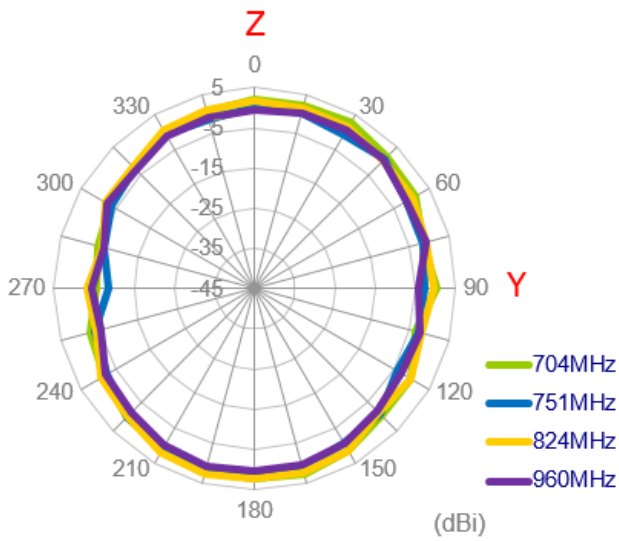

3.3.2 3D Radiation Patterns (LTE_MIMO1 with 3M cable length in free space)

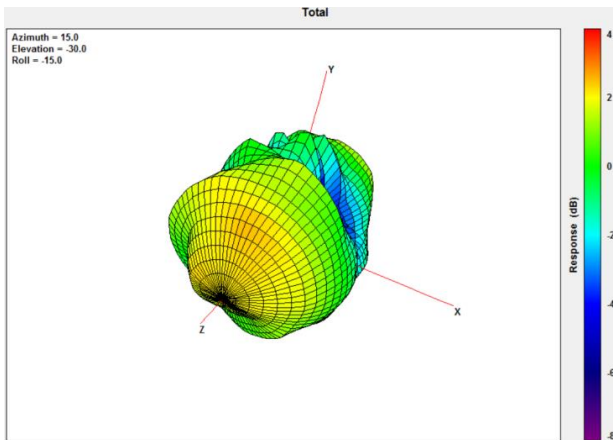

704MHz

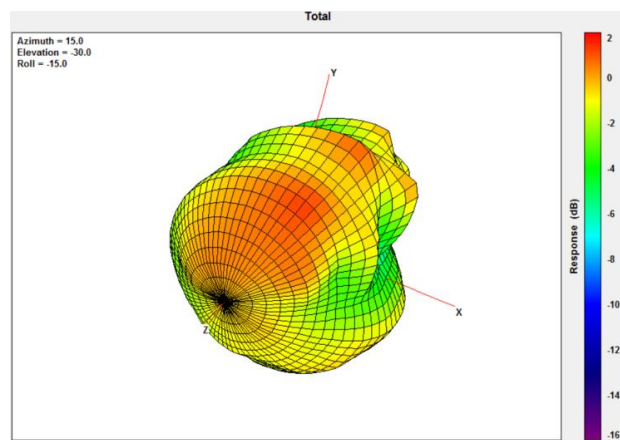

960MHz

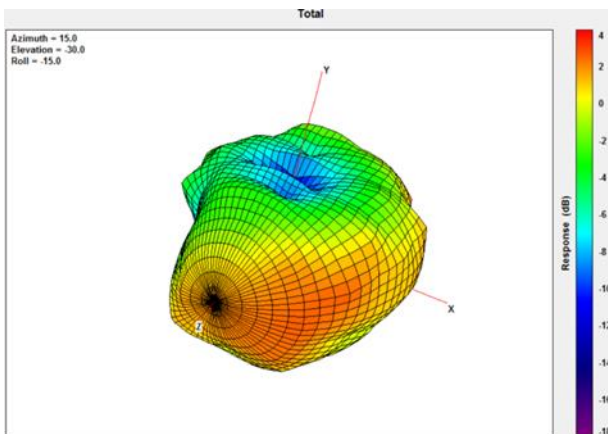

1710MHz

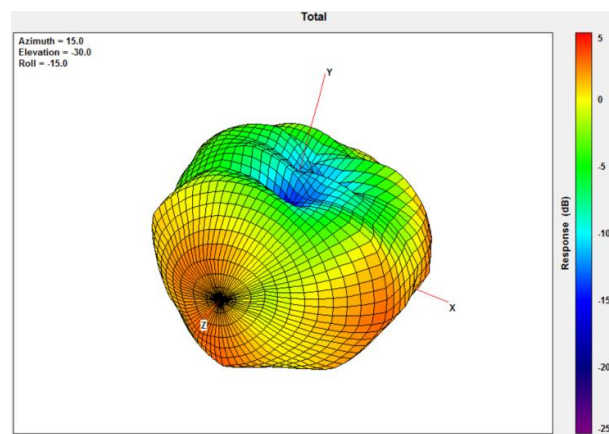

2170MHz

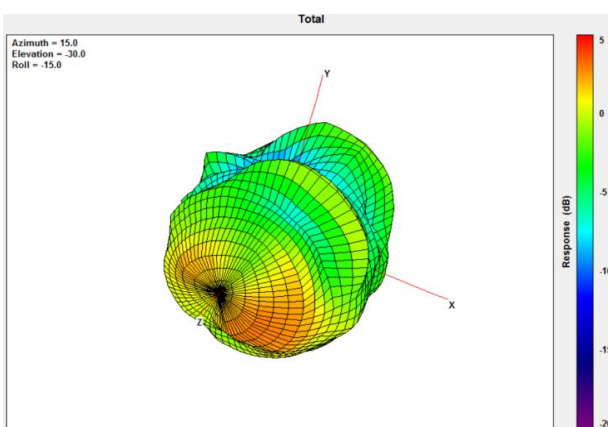

2690MHz

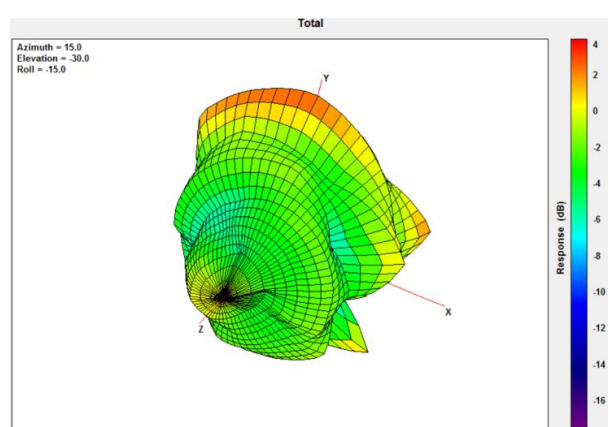

3500MHz

3.3.3 2D Radiation Patterns (LTE_MIMO2 with 3M cable length in free space)

XY Plane

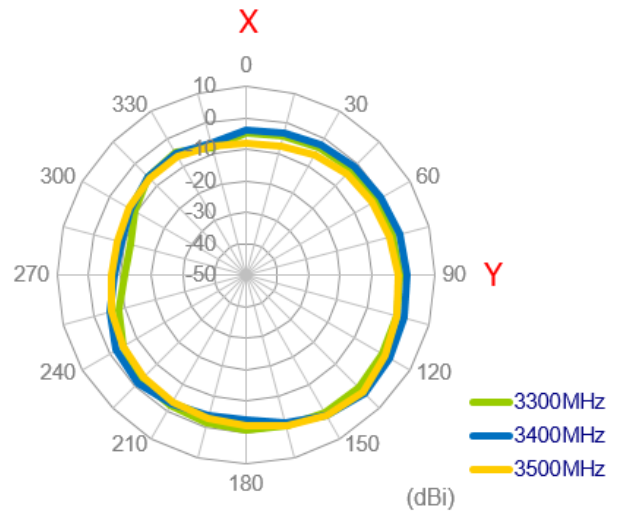
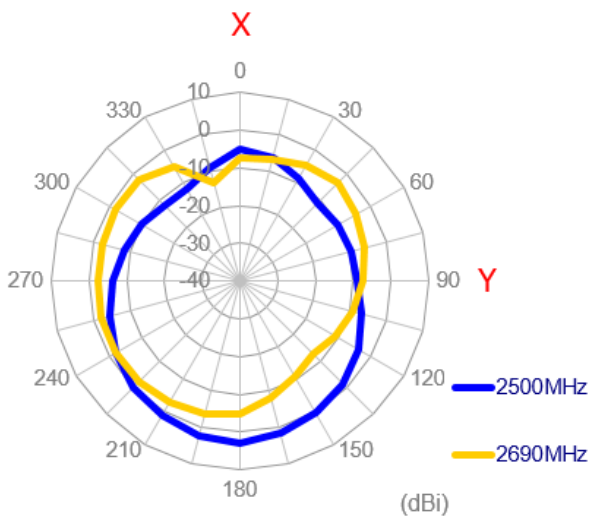
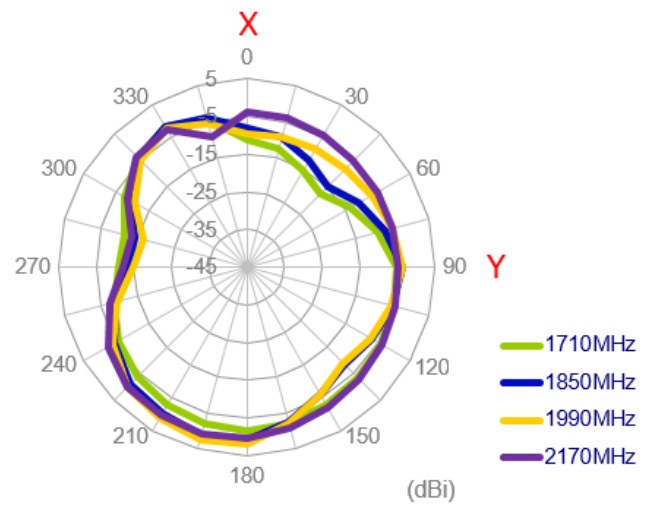
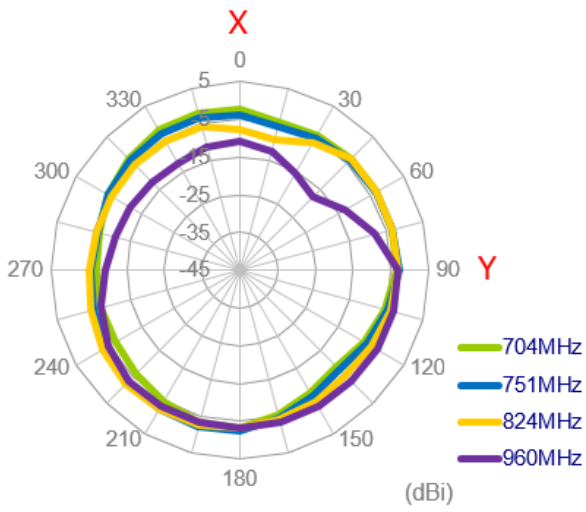

XZ Plane

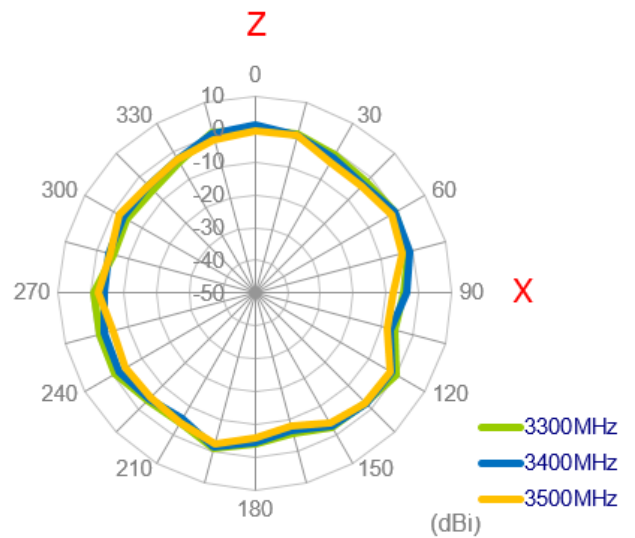
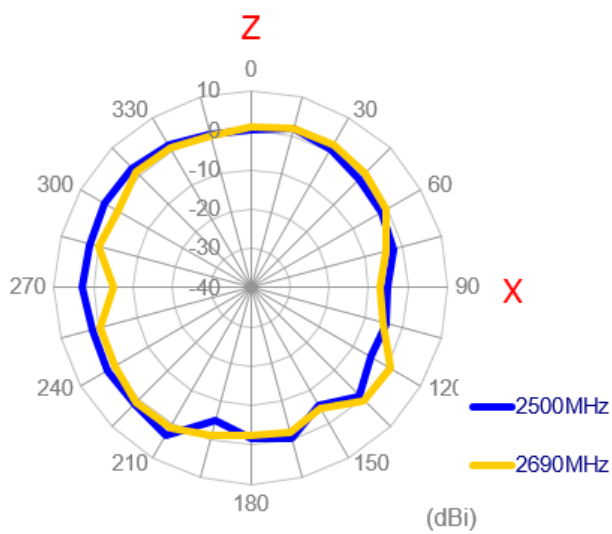
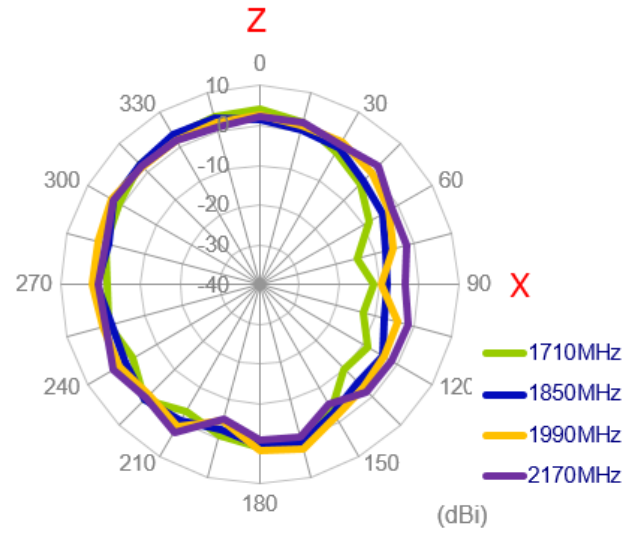
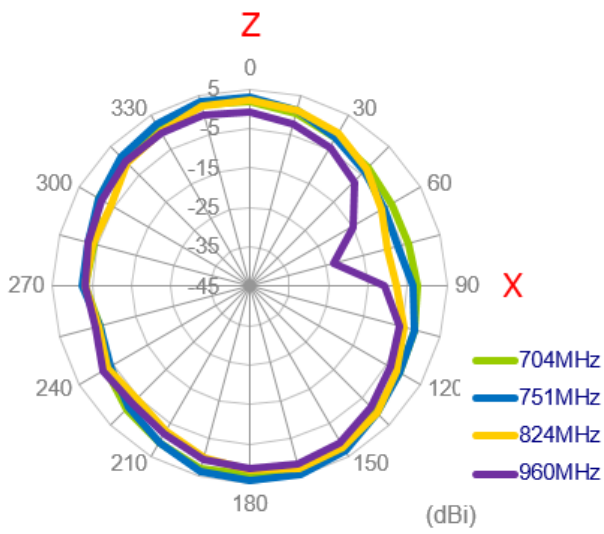

YZ Plane

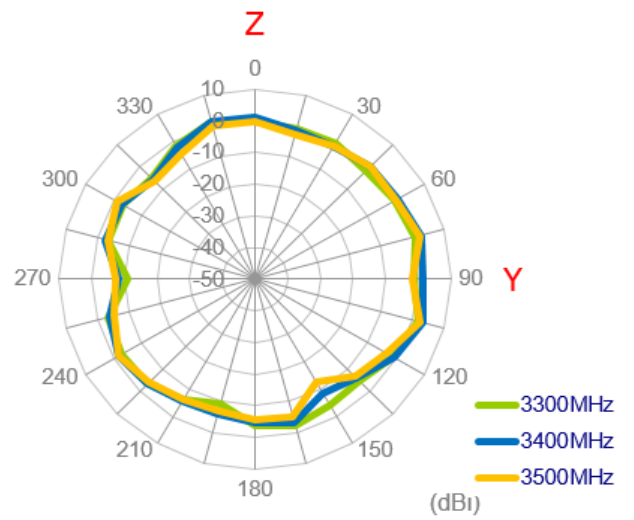
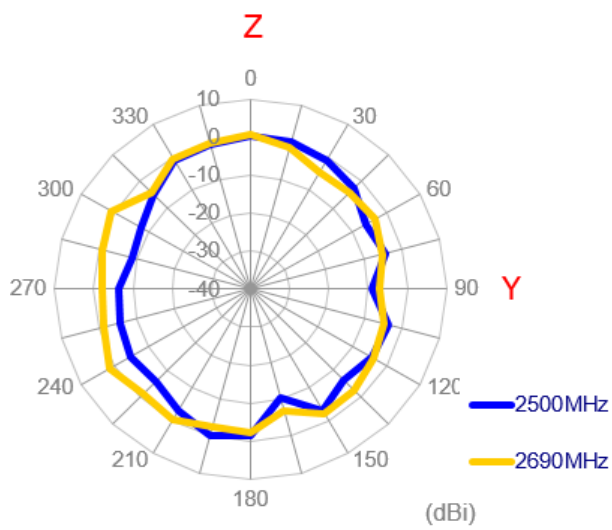
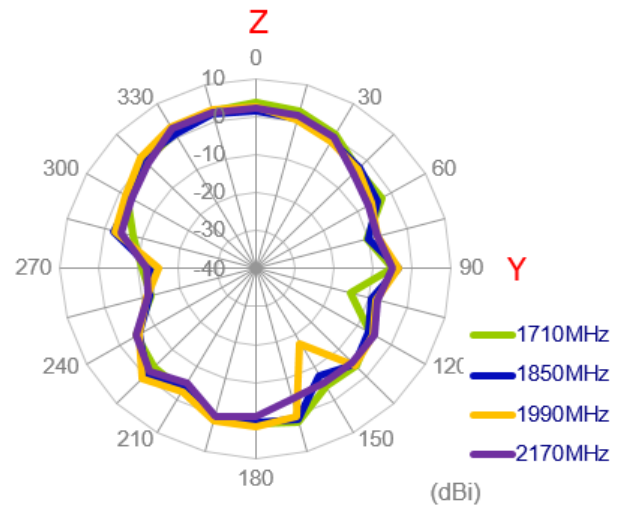
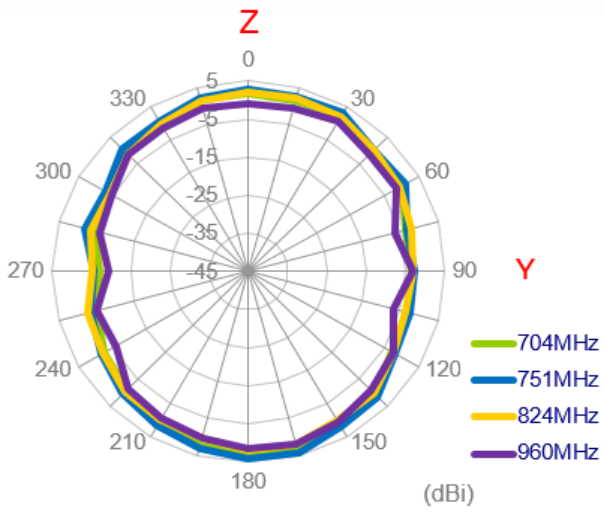

3.2.4 3D Radiation Patterns (LTE_MIMO2 with 1M cable length in free space)

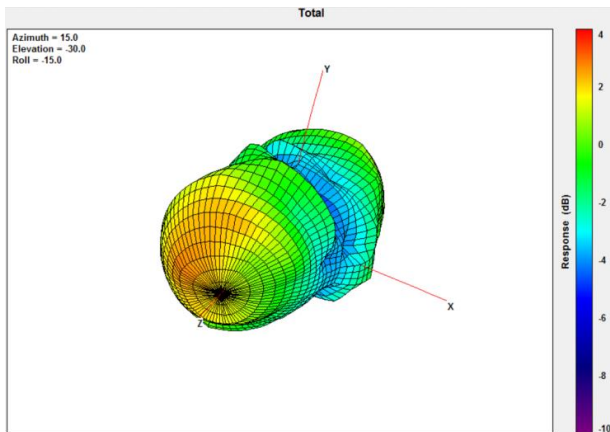

704MHz

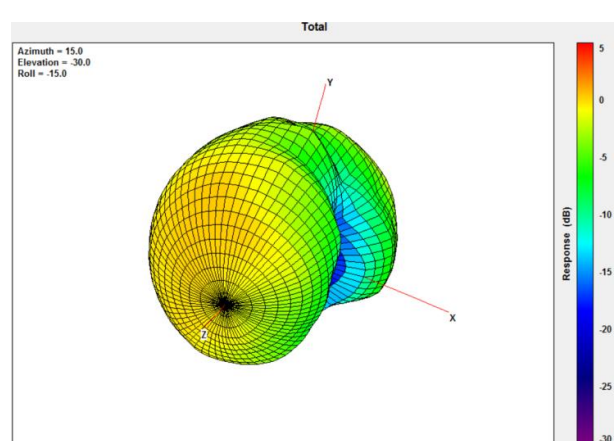

960MHz

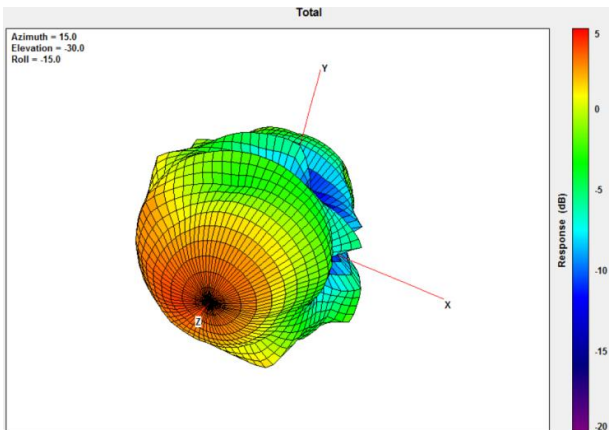

1710MHz

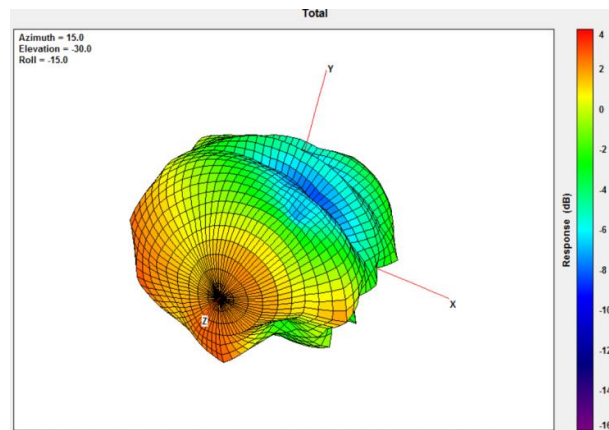

2170MHz

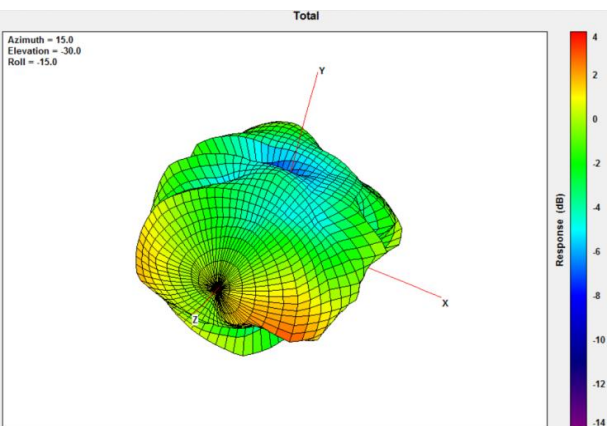

2690MHz

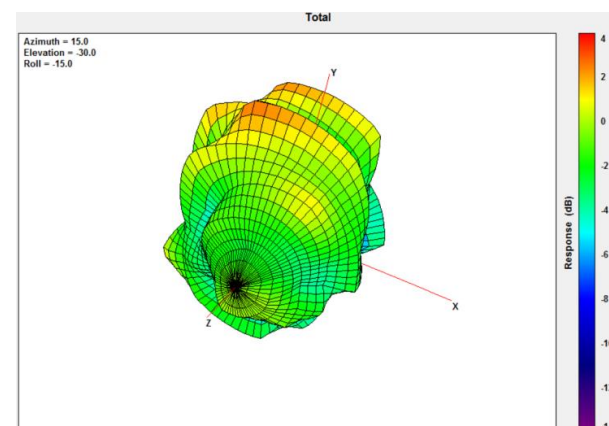

3500MHz

3.2.5 2D Radiation Patterns (LTE_MIMO1 with 3M cable length in free space)

XY Plane

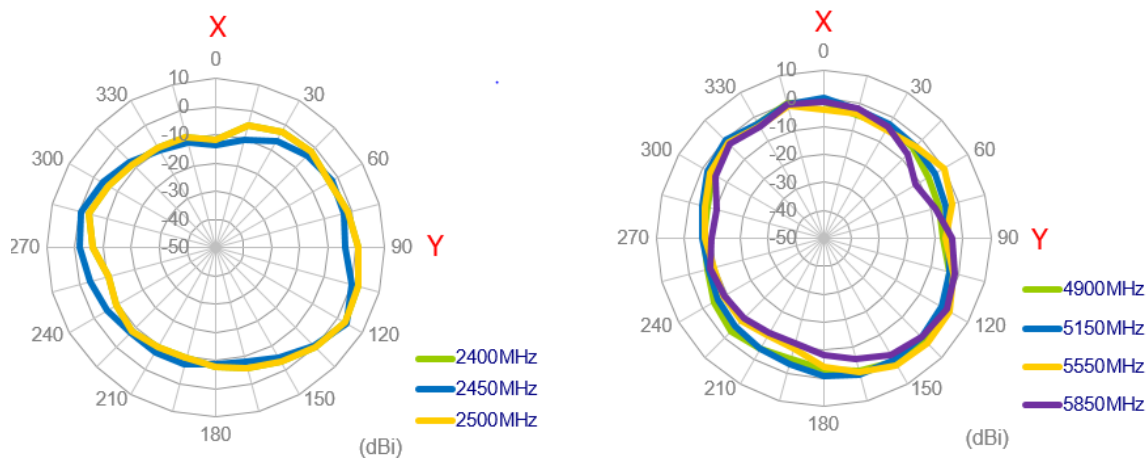

XZ Plane

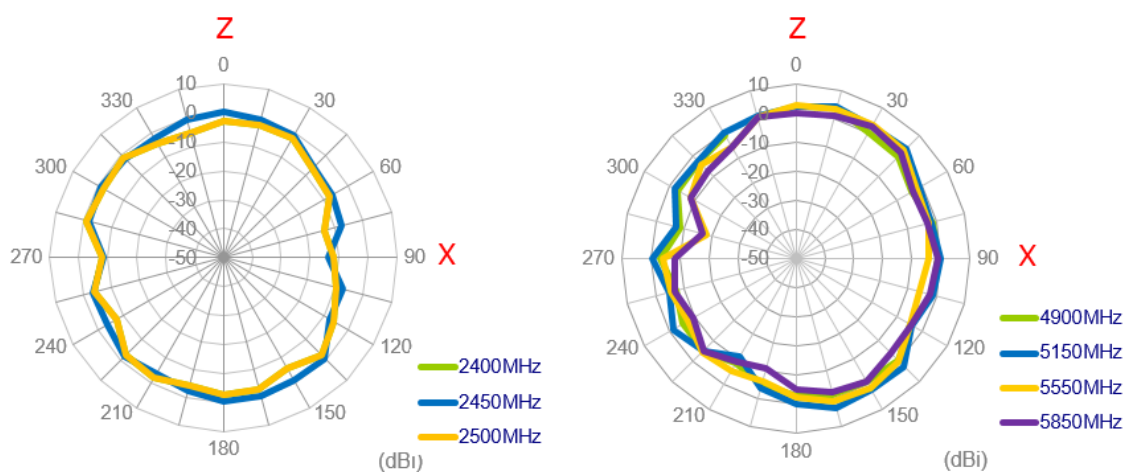

YZ Plane

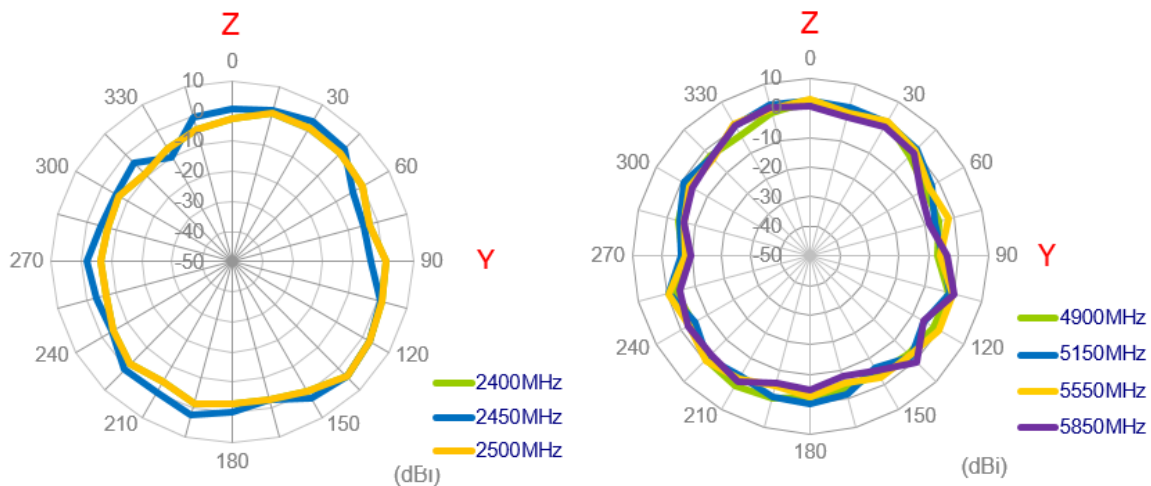

3.2.6 3D Radiation Patterns Pattern (Wi-Fi_MIMO1 with 3M cable length in free space)

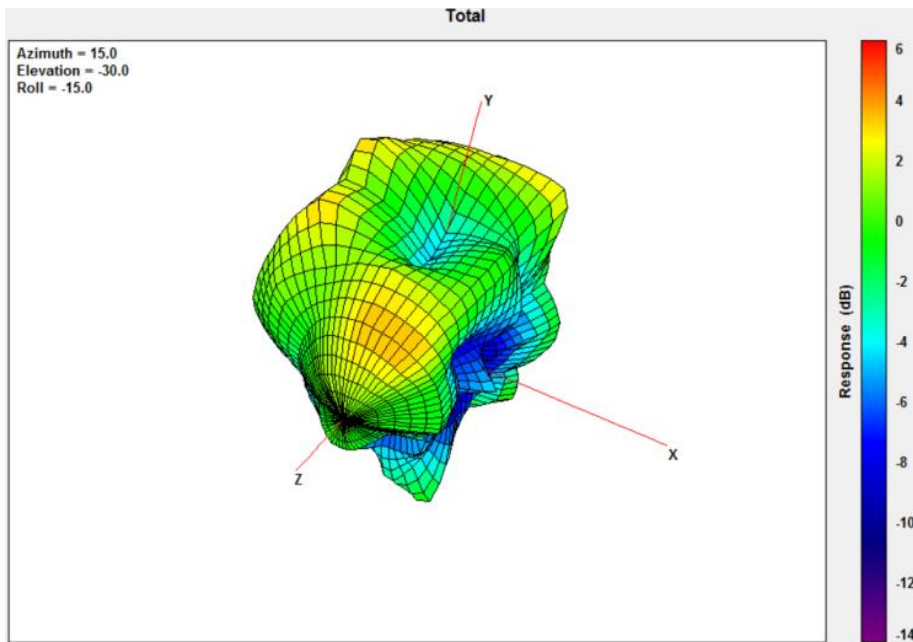

2450MHz

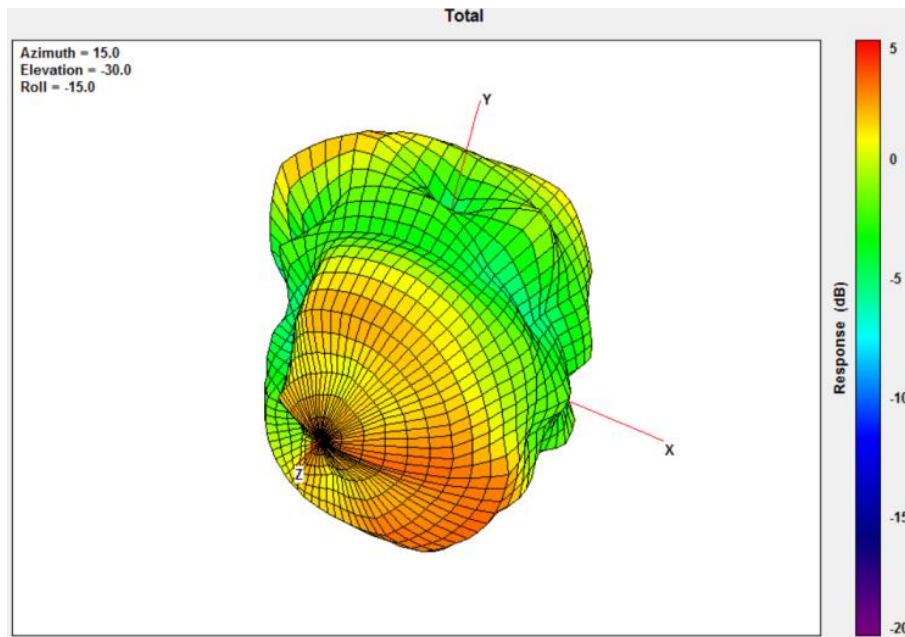

5550MHz

3.2.7 2D Radiation Patterns (Wi-Fi_MIMO2 with 3M cable length in free space)

XY Plane

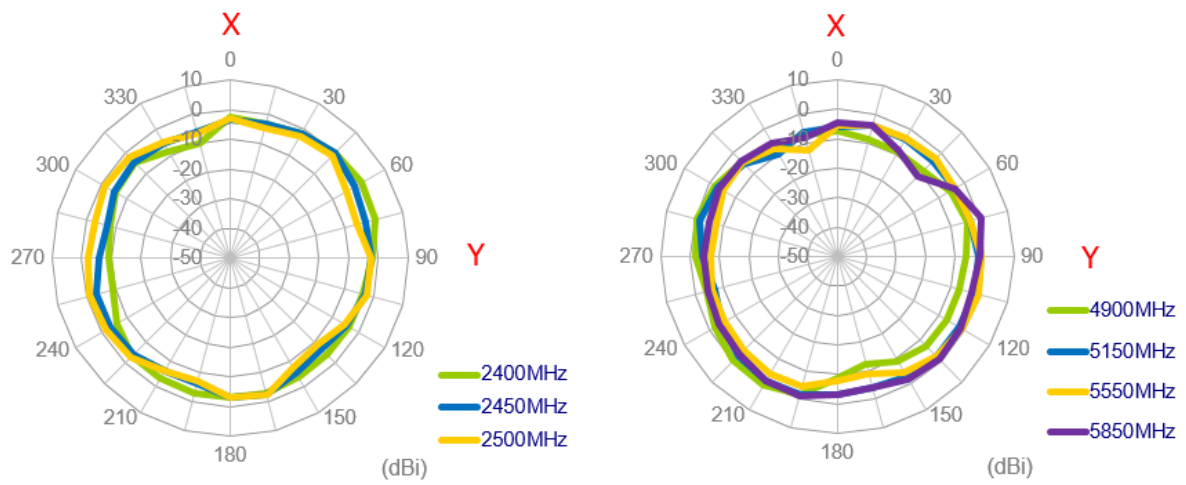

XZ Plane

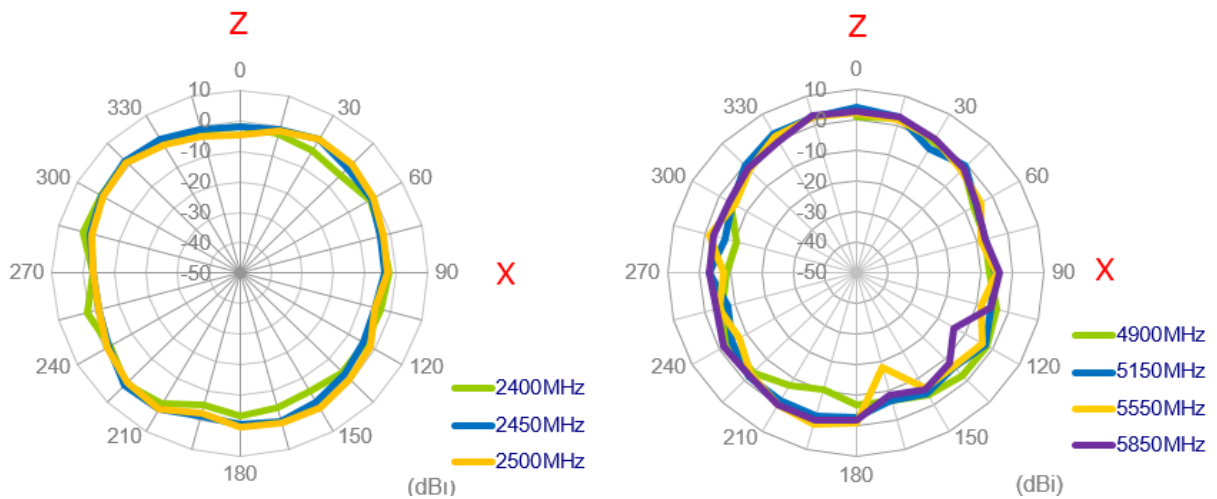

YZ Plane

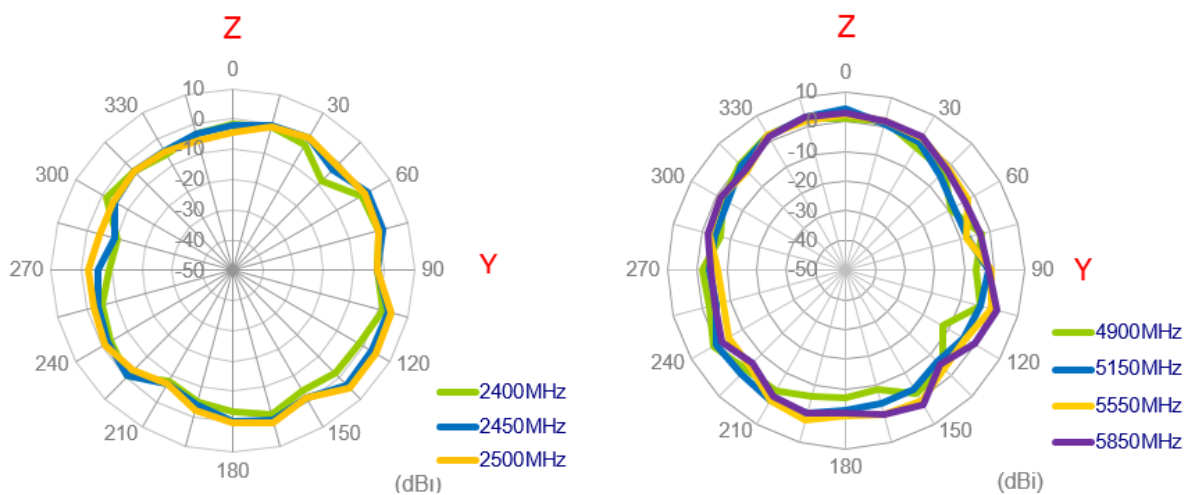

3.2.8 3D Radiation Patterns Pattern (Wi-Fi_MIMO2 with 3M cable length in free space)

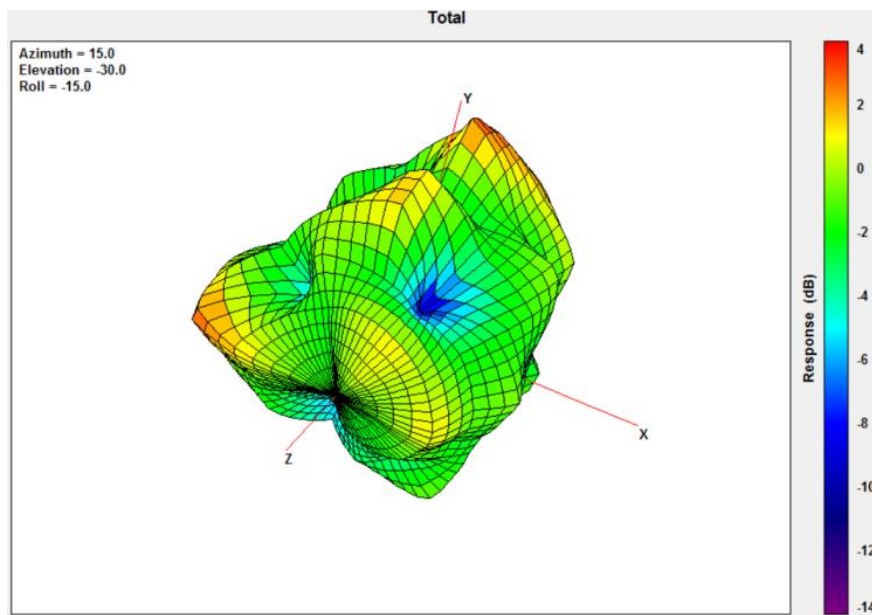

2450MHz

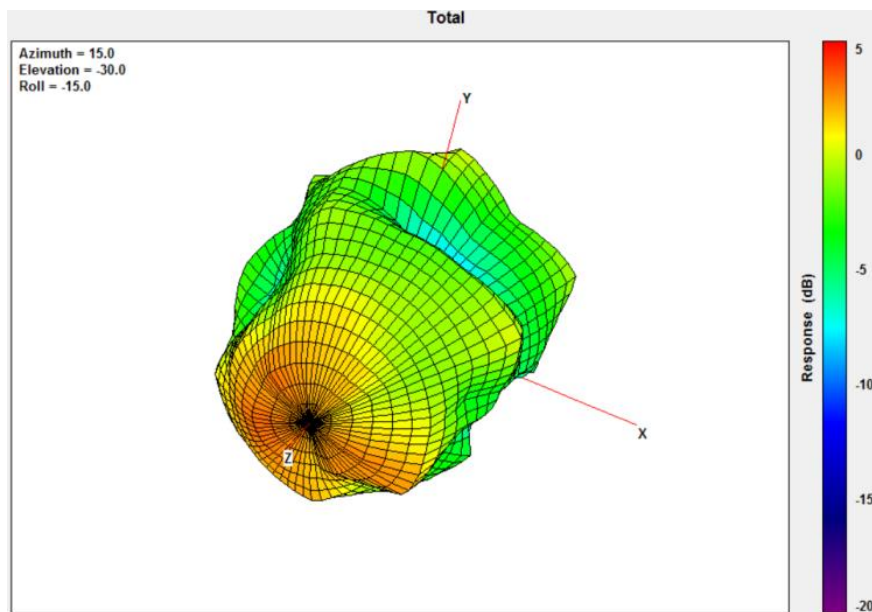

5550MHz

4. Mechanical Drawing (Units: mm)

| | | | | | | | |
|-----------------------|---|-----------|------|--|----------|----------|-------------|
| 6 | 5 | 4 | 3 | 2 | 1 | | |
| ISO NO: EDW-18-8-6262 | | <Release> | | | | | |
| | | REV | ZONE | DESCRIPTION | ENG | APPROVED | ISSUED DATE |
| | | △01 | ALL | Initial Design | Haley | Paul | 2017/08/11 |
| | | △02 | ALL | Cancel Double Sided Adhesive. | Bonnie | Paul | 2017/08/22 |
| | | △03 | ALL | Change Label to Heat Shrink Tube with Printing Text. Amend QTY of Screw TP4x25L & Wall mount stud 6x24L. | Bonnie | Paul | 2017/11/16 |
| | | △04 | ALL | Separate the bracket. | Bonnie | Sky | 2018/02/02 |
| | | △05 | ALL | Modify the Cable to TGC-200<EG-21-08-004> | Aron Yan | Aaron | 2022/08/08 |

Front View △05

Side View △05

Back View △05

Bottom View △05

Detail A
SMA(M)ST
Scale: 2:1

Detail B
RP-SMA(M)ST
Scale: 2:1

| Name | P/N | Material | Finish | QTY |
|-----------------------------|----------------|-----------------|------------------------|-----|
| 1 Top Housing | 000116B000000A | ASAB23S | Black | 1 |
| 2 Bottom Housing | 000116B010000A | ASAB23S | Black | 1 |
| 3 Rubber-2 Holes | 000715H010000A | Silicone Rubber | Black | 2 |
| 4 Clear Label | 001015H040000A | PET | Transparent | 1 |
| 5 Heat Shrink Tube(LTE-1) | 001317C020000A | PE | Red Tube/White Text | 1 |
| 6 Heat Shrink Tube(LTE-2) | 001317C030000A | PE | Red Tube/White Text | 1 |
| 7 Heat Shrink Tube(Wi-Fi-1) | 001316L060000A | PE | Yellow Tube/Black Text | 1 |
| 8 Heat Shrink Tube(Wi-Fi-2) | 001316L070000A | PE | Yellow Tube/Black Text | 1 |
| 9 Hook_Key | 000117D020000A | ASAB23S | Black | 1 |
| 10 Empty Label(48*30) | 001015G000000A | PEPA | White | 1 |
| 11 Barcode Label(25*9) | 001015G010000A | PET | White | 1 |
| 12 MA9 Series Bracket | 000117E060000A | ASAB23S | Black | 1 |
| 13 Screw TP1(3x8L) | 000416J000000A | Steel | Ni Plated | 3 |
| 14 Fastening Washer | 000116I000000A | ASAB23S | Black | 3 |
| 15 Screw TP4x25L | 000411A040054A | Steel | Ni Plated | 2 |
| 16 Wall mount stud 6x24L | 000411A050054A | Nylon | White | 2 |

| Name | P/N | SPEC | Finish | QTY |
|-------------------|----------------|-------------|-----------|-----|
| XX TGC-200 Cable | 305416B000000A | KSR200-P | Black | 4 |
| YY Connector Type | 200220C00001GA | SMA(M)ST | Au Plated | 2 |
| ZZ Connector Type | 200220K00001GA | RP-SMA(M)ST | Au Plated | 2 |

Notes:

- All material must be RoHS compliant.
- Color Codes: PANTONE Black / Plastics Color Q728-1-1.
- Finish: Mirror Polish / SPI A-2.
- Deburring: Less than 0.02mm.
- No gate, parting line and any other tooling marks on appearance of product.
- Once product have any crack/break/thread damage or any structural tooling issue, molding supplier need to correct the issue unconditionally.
- Use this drawing together with the corresponding 3D CAD database file to fully describe the part.
- The connector orientation has a fixed position to the antenna as per drawing.
- Double Sided Adhesive Area :
- Part No.: MA961.A.B30PP111.J30PP111.C30PP151.G30PP151.wm
- ** Critical Dimensions.

| | | | |
|---|------------------------|-----------------|-----|
| UNLESS OTHERWISE SPECIFIED TOLERANCES ON: | DATE: 2017/08/11 | MAT'L: | REV |
| | UNIT: mm | FINISH: | |
| XX±0.5 .XX±0.1 X±0.3 .XXX±0.05 | THIRD ANGLE PROJECTION | SCALE: 1/4 | D05 |
| APPROVED BY: Paul | CHECKED BY: Jack | DRAWN BY: Haley | |

| | |
|---|--|
| TW Design Centre This drawing and its inherent design concepts are property of Taoglas. Not to be copied or given to third parties without the written consent of Taoglas. | |
| TITLE: :4in1 Adhesive 3000mm: LTE(1&2) TGC-200 SMA(M): Wi-Fi(1&2) TGC-200 RP-SMA(M) Wall Mount | |
| PART NO. : MA961.A.BICG.002.wm | |

6. Packaging

1 MA961.A.BICG.002.wm per small box
 Box Dimensions - 260 x 235 x 105mm
 Weight - 1000g

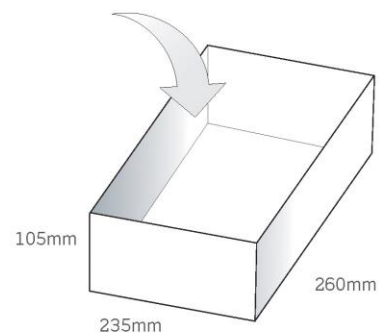
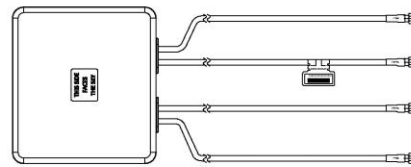

1 Outer Carton
 Carton Dimensions - 540 x 490 x 240mm
 8 pcs MA961.A.BICG.002.wm per carton
 Weight - 9.01Kg

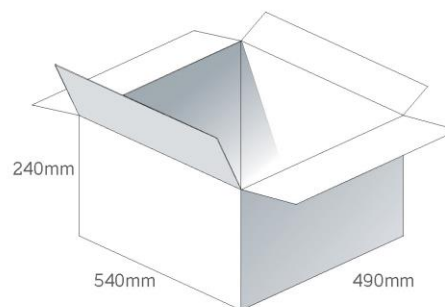

Pallet Dimensions 1200*1000*1400mm
 20 Cartons per Pallet
 4 Cartons per layer
 5 Layers

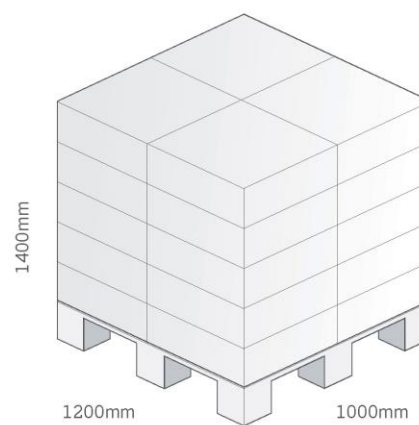

7. Application Note

7.1 In free space (LTE)

7.1 Return Loss (LTE MIMO 1)

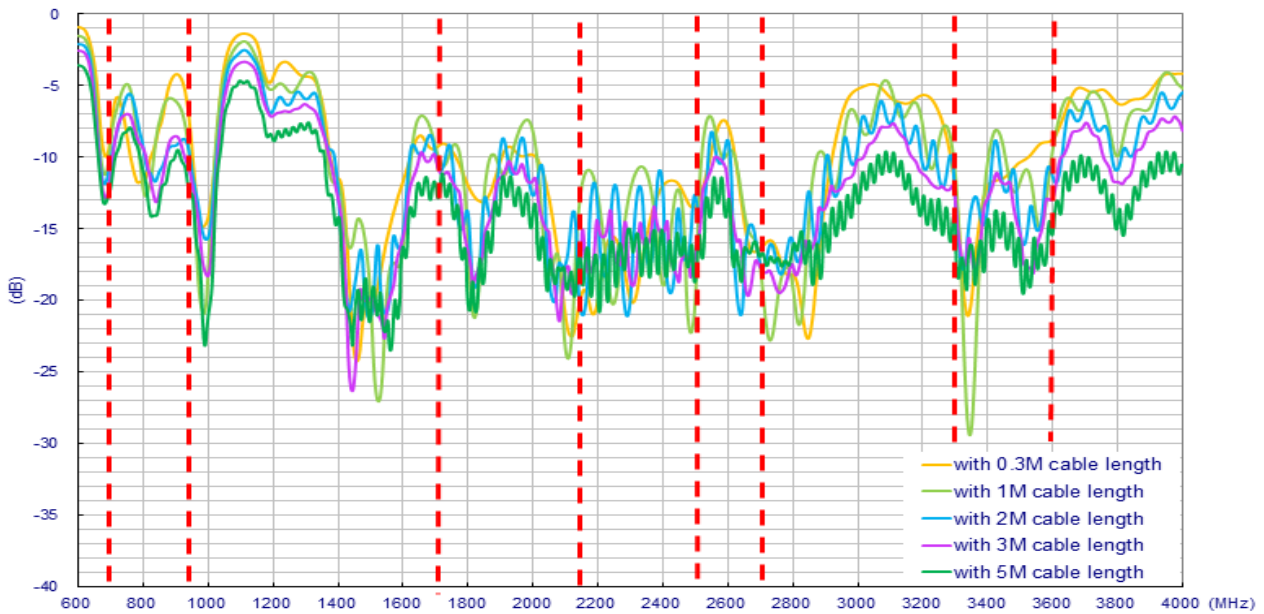

The MA961 antenna performance with different cable lengths is shown below.

7.1.2 Return Loss (LTE MIMO 2)

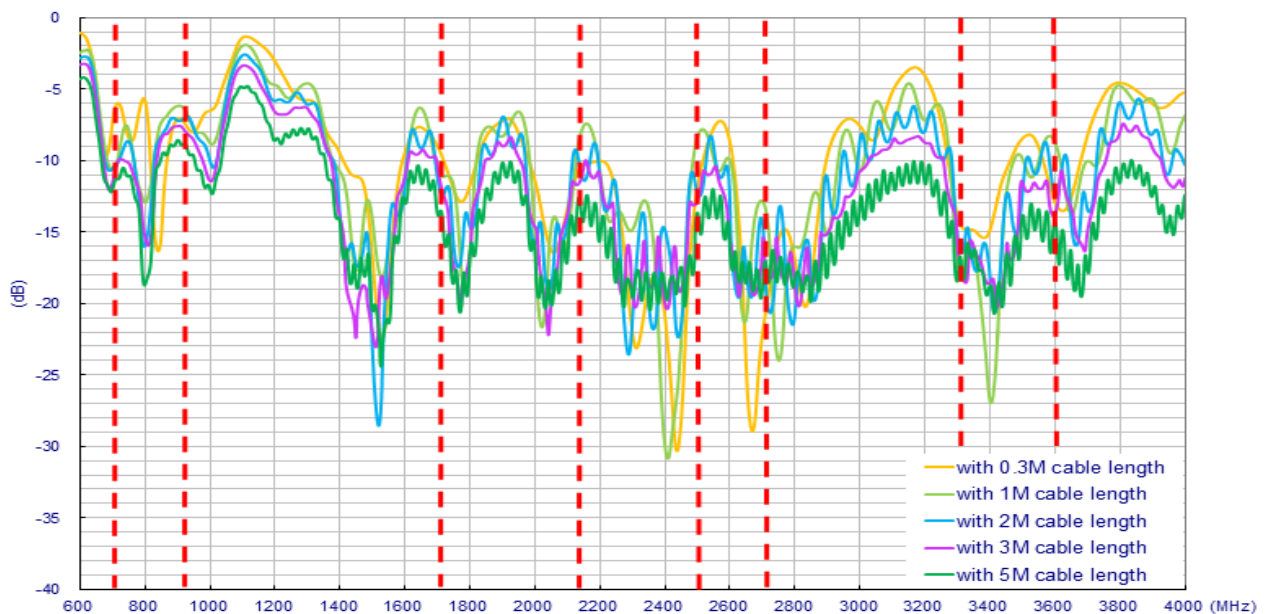

7.1.3 Isolation (LTE antenna)

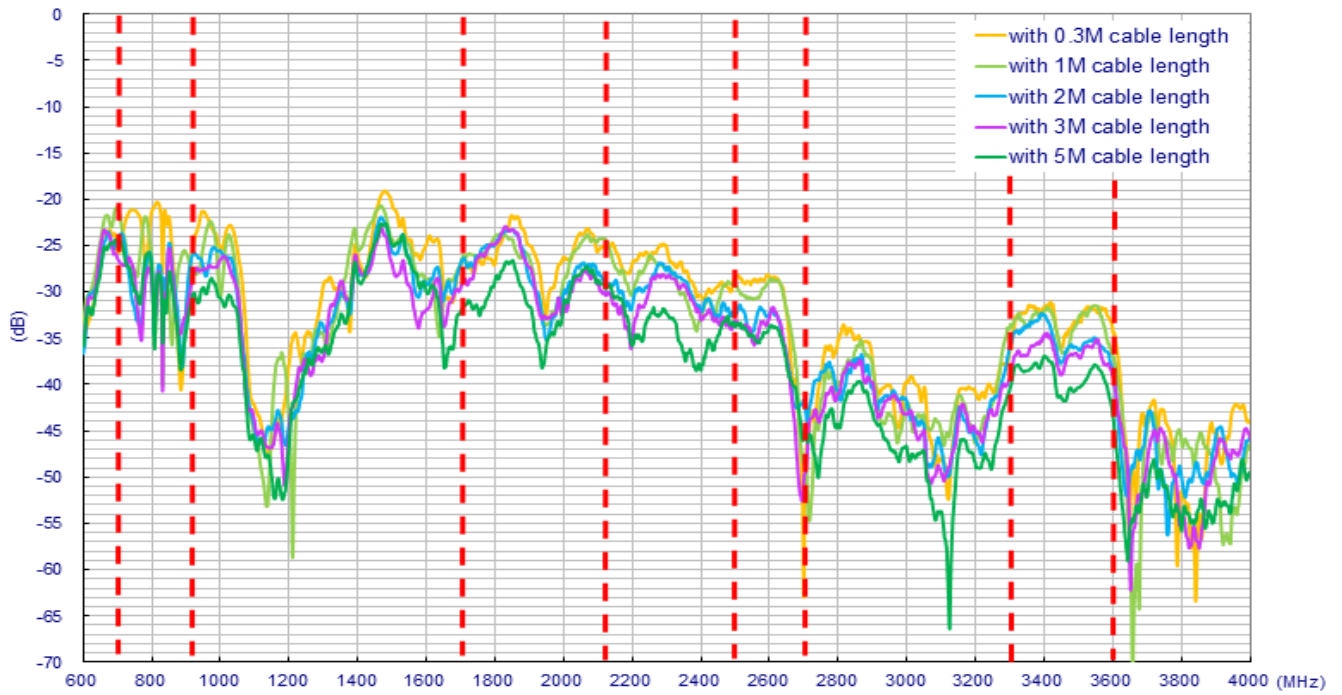

7.1.4 Return Loss (LTE MIMO 2)

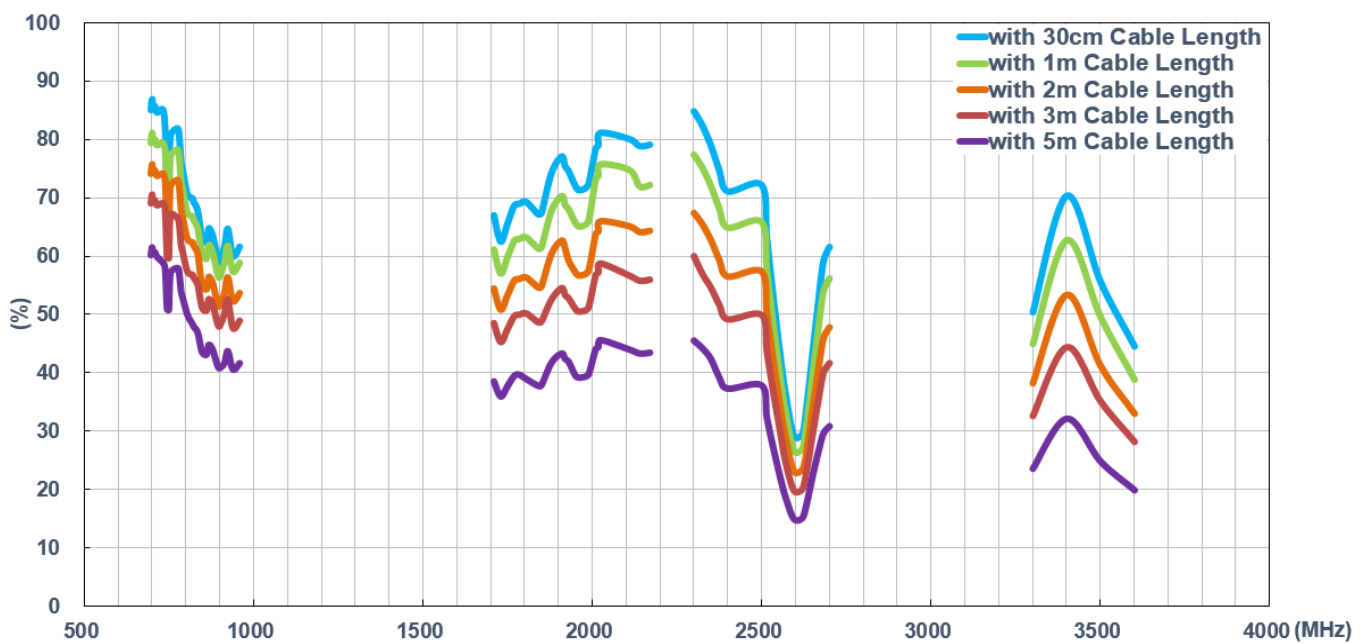

7.1.5 Efficiency (LTE MIMO 2)

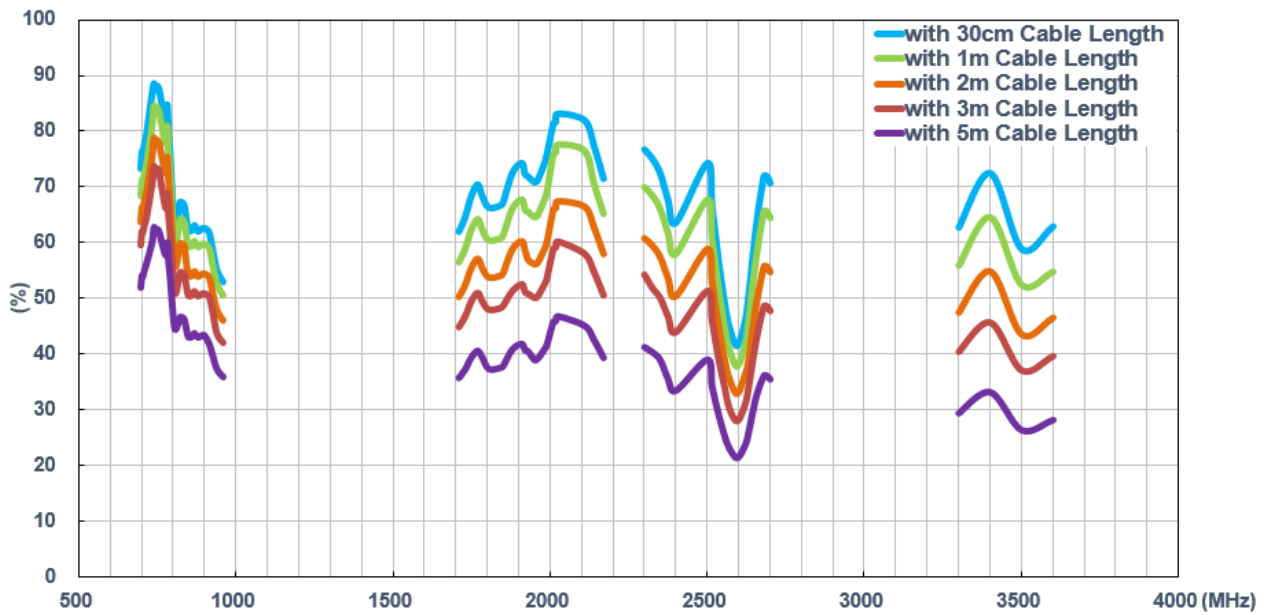

7.1.6 Average Gain (LTE MIMO 1)

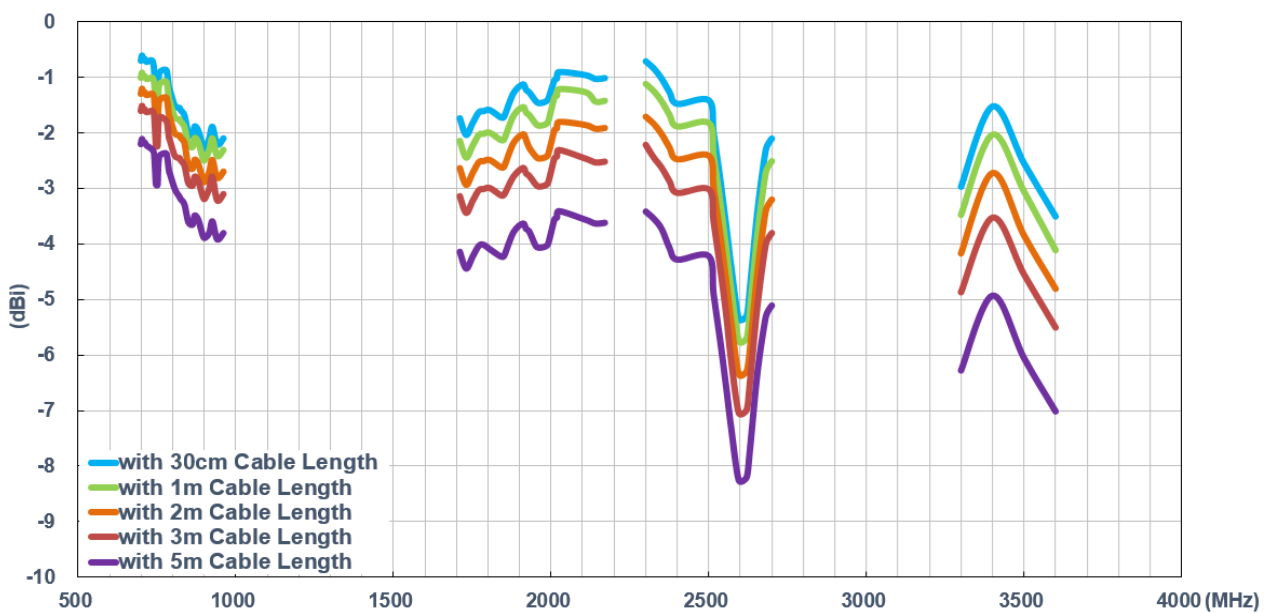

7.1.7 Average Gain (LTE MIMO 2)

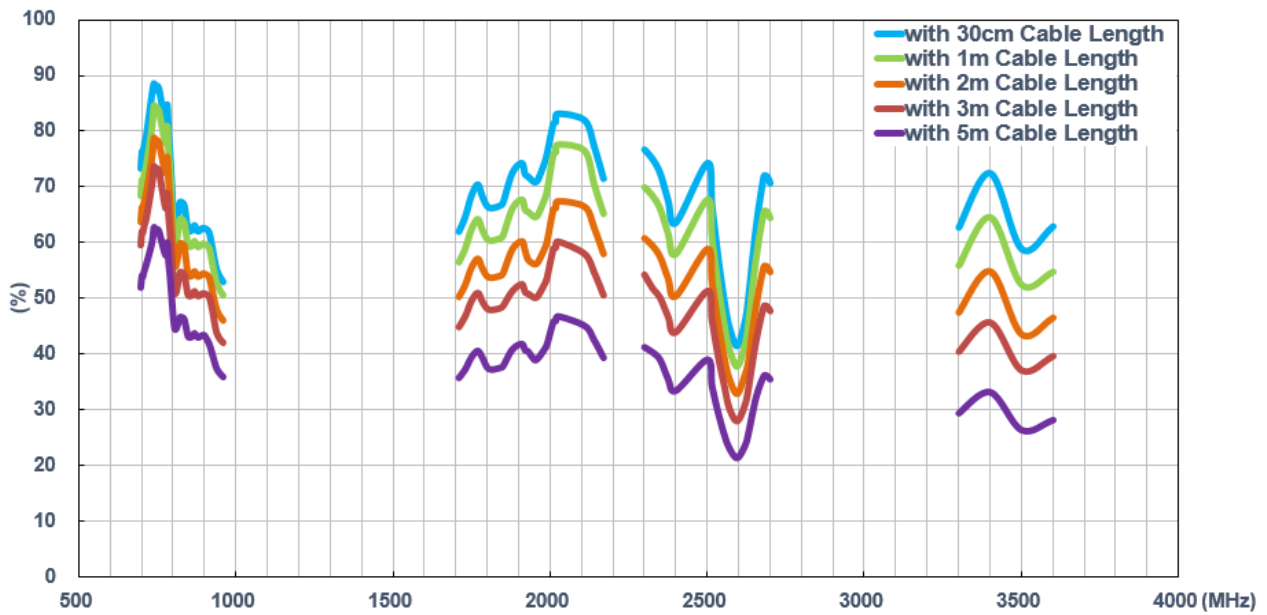

7.1.8 Peak Gain (LTE MIMO 1)

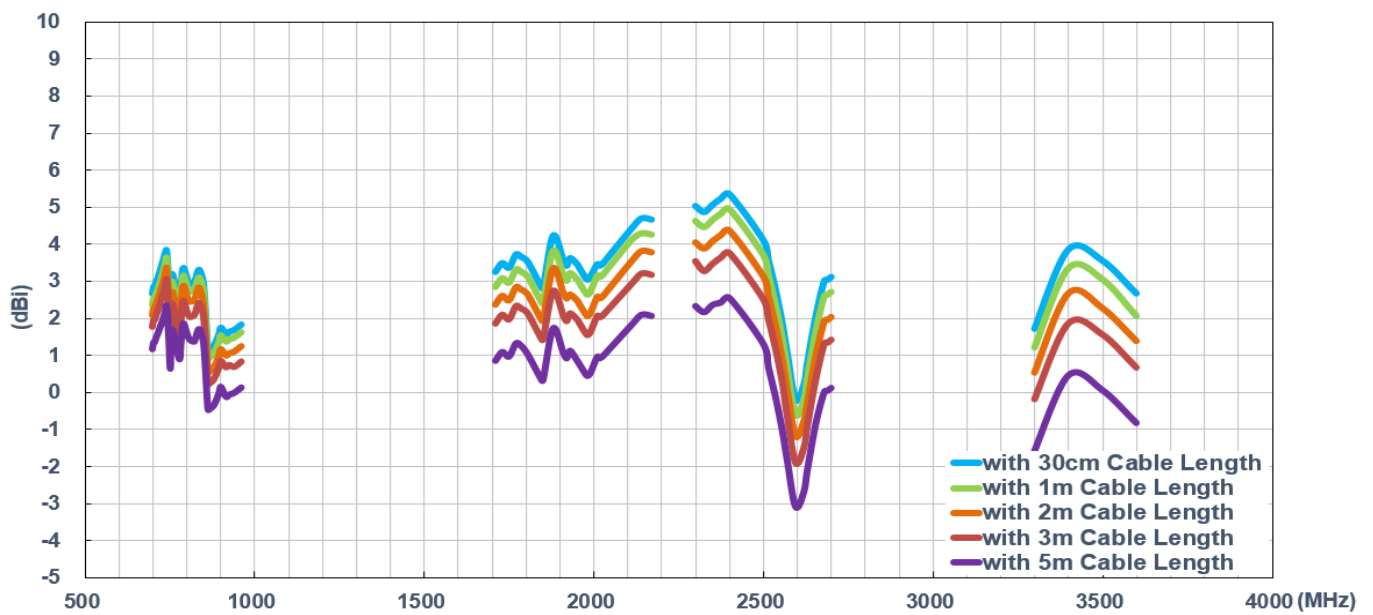

7.1.9 Peak Gain (LTE MIMO 2)

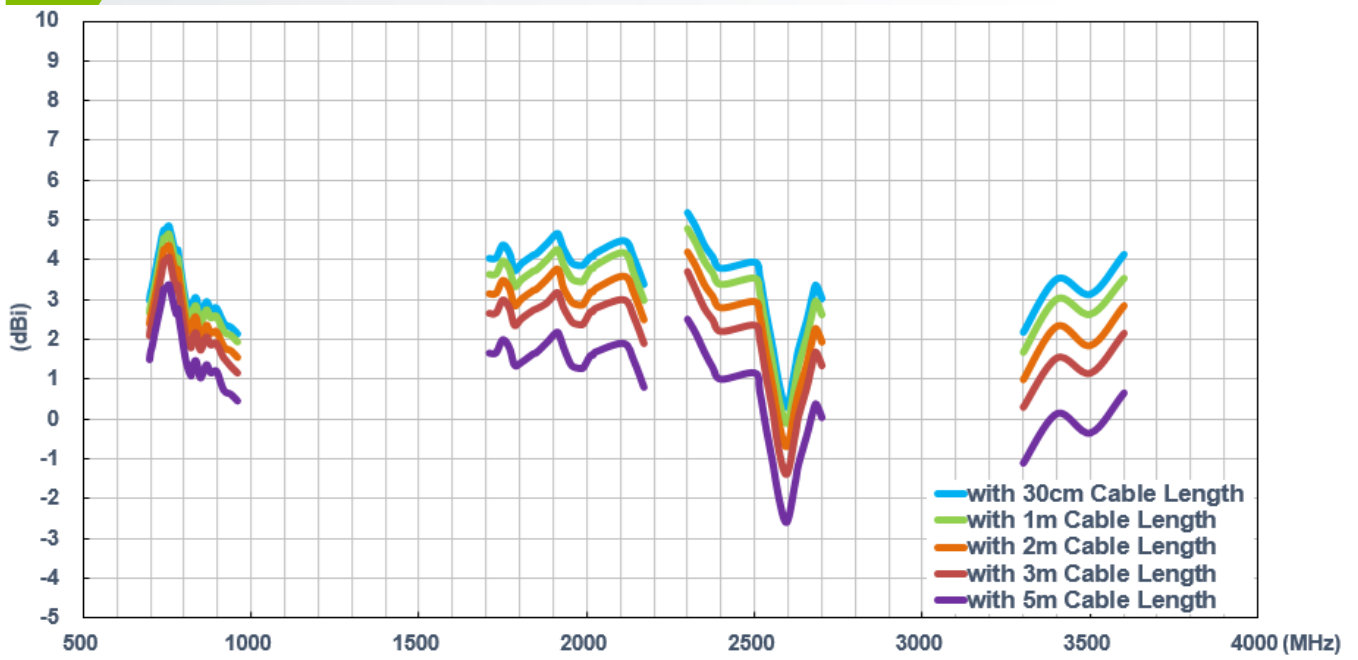

7.2 In free space (Wi-Fi)

7.2.1 Return Loss (Wi-Fi MIMO 1)

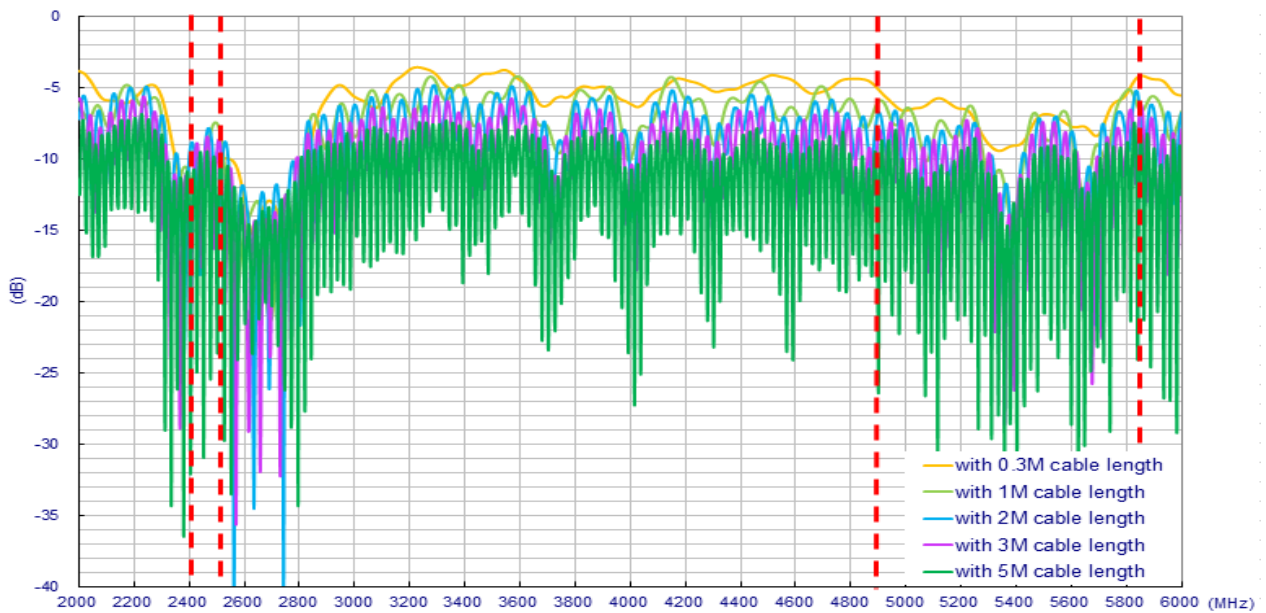

7.2.2 Return Loss (Wi-Fi MIMO 2)

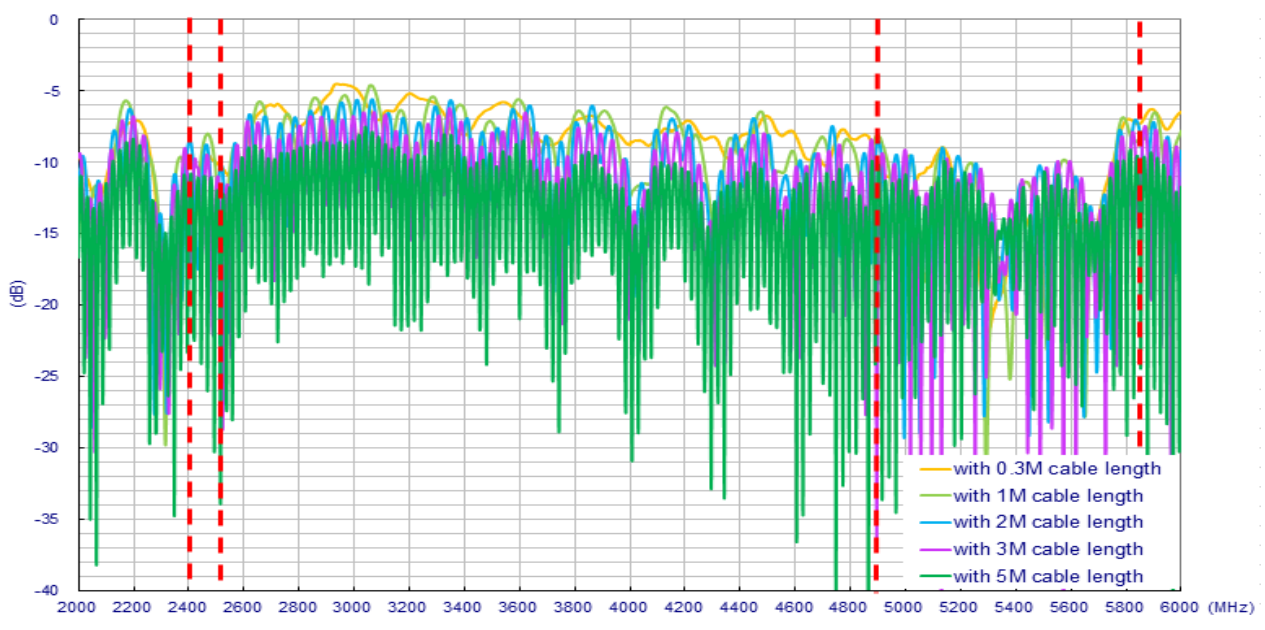

7.2.3 Isolation (Wi-Fi)

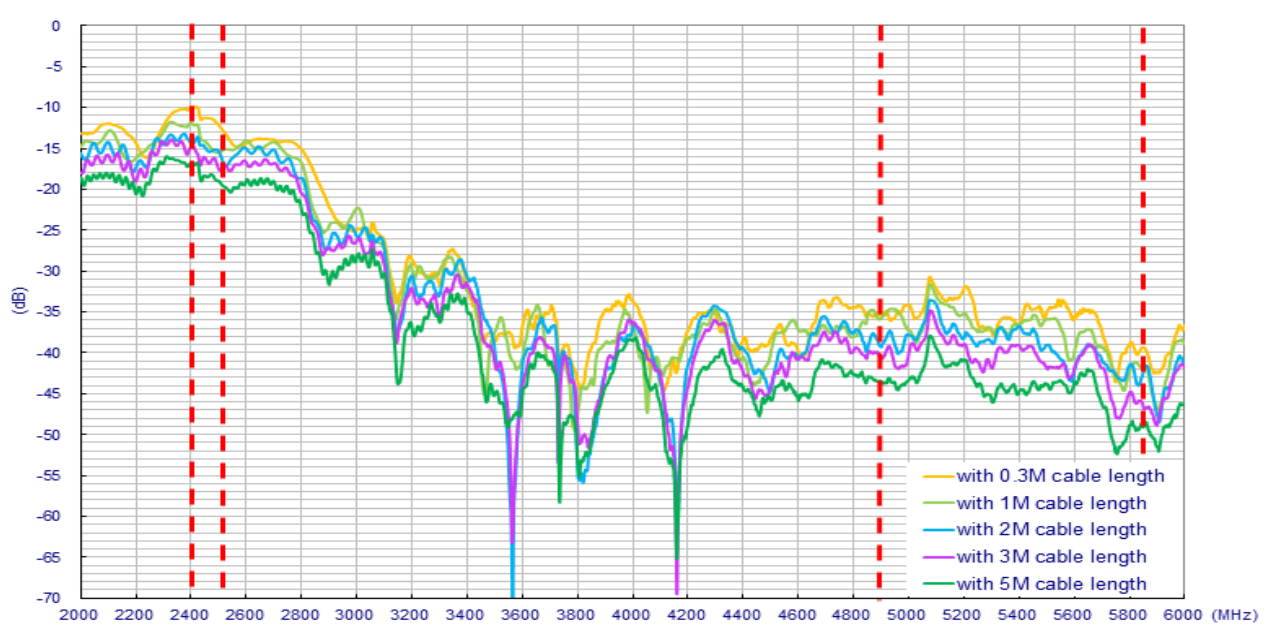

7.2.4 Efficiency (Wi-Fi MIMO 1)

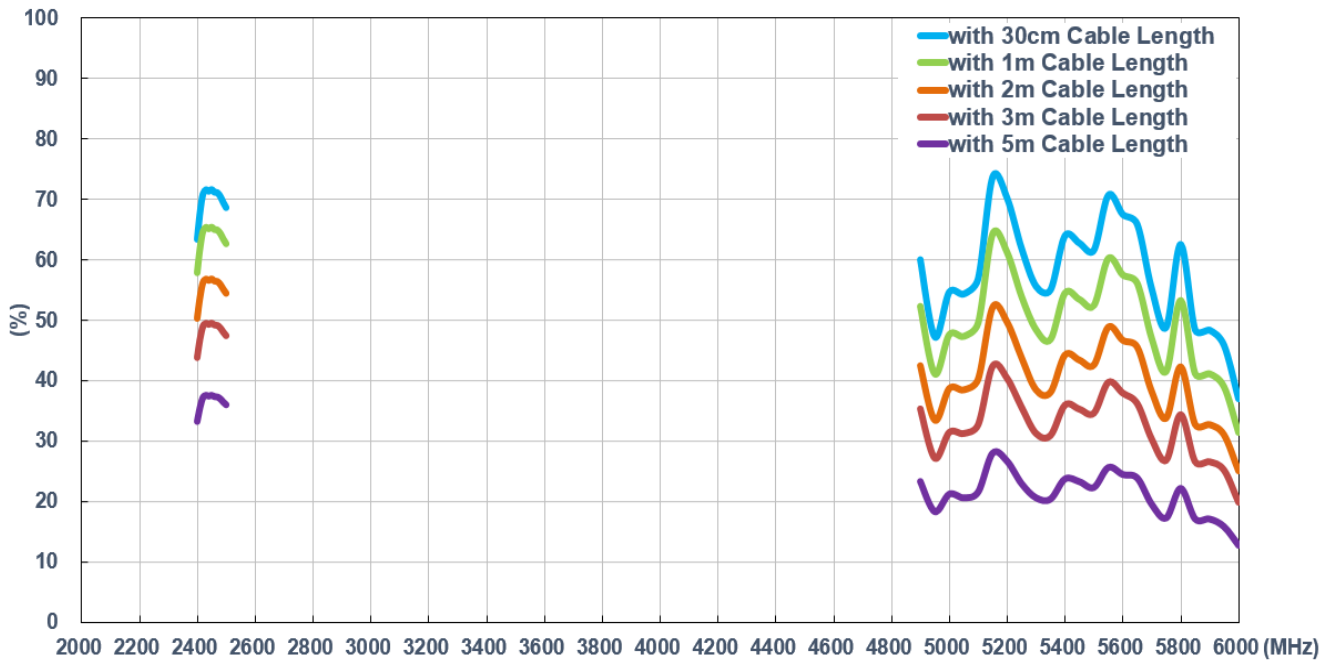

7.2.5 Efficiency (Wi-Fi MIMO 2)

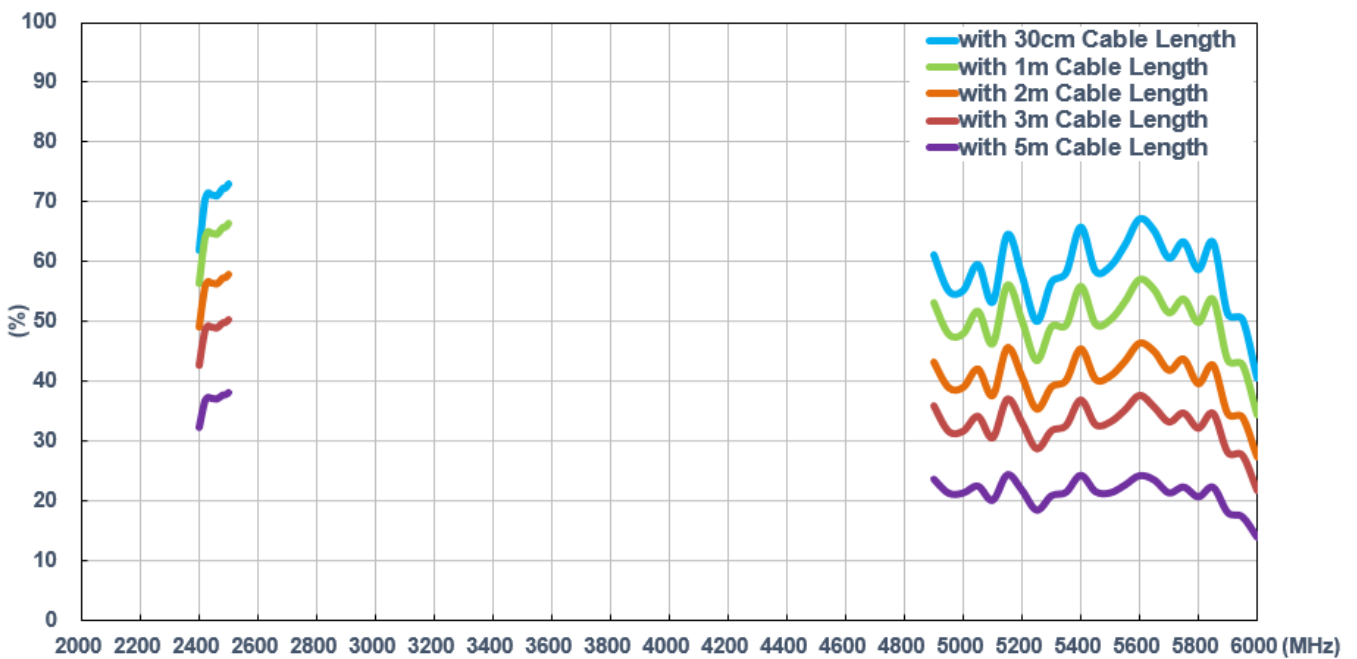

7.2.6 Average Gain (Wi-Fi MIMO 1)

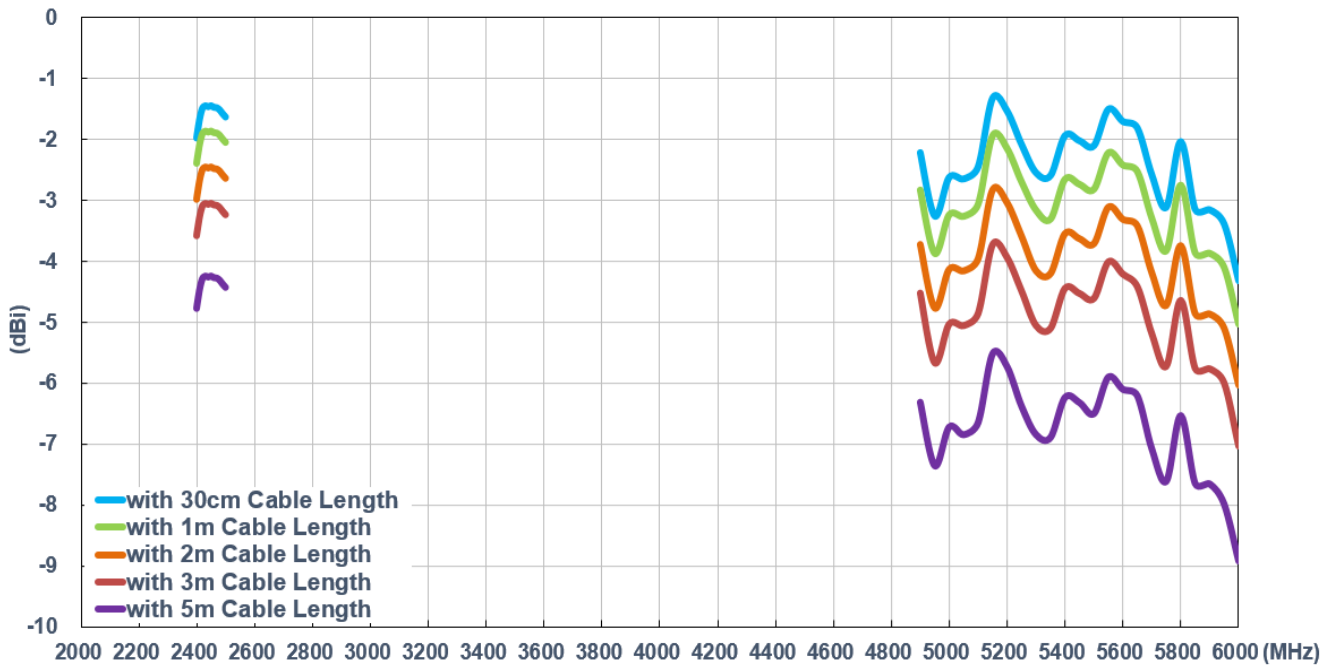

7.2.7 Average Gain (Wi-Fi MIMO 2)

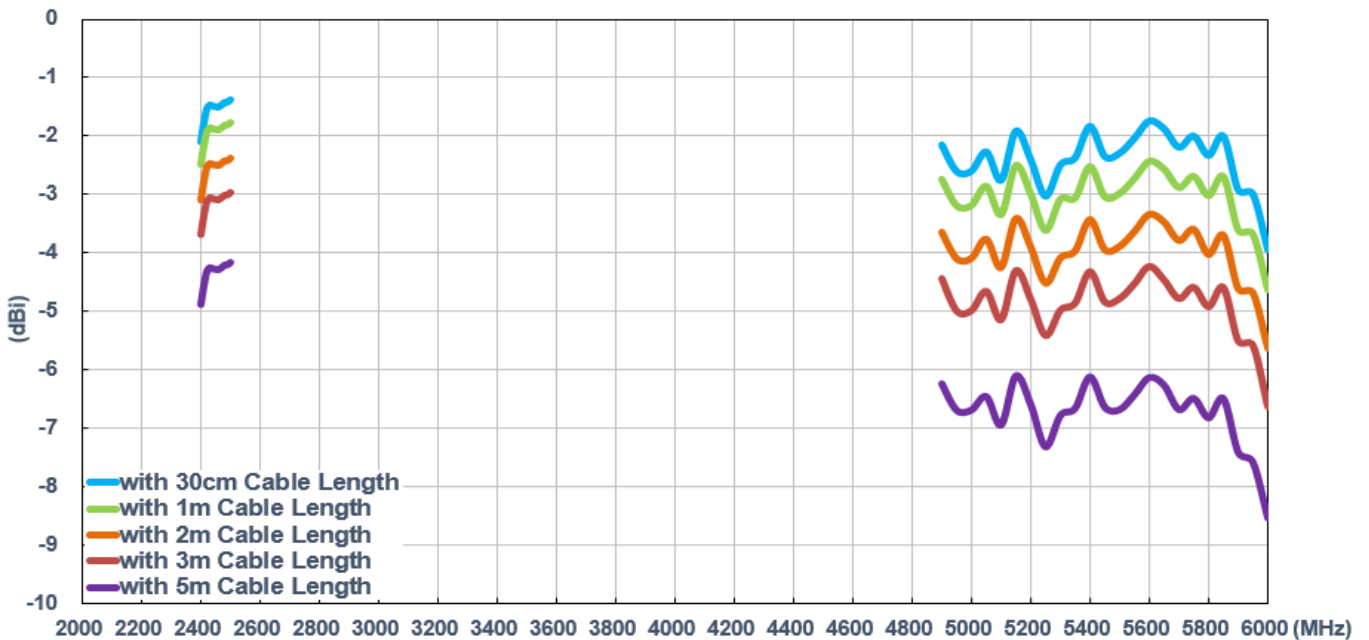

7.2.8 Peak Gain (Wi-Fi MIMO 1)

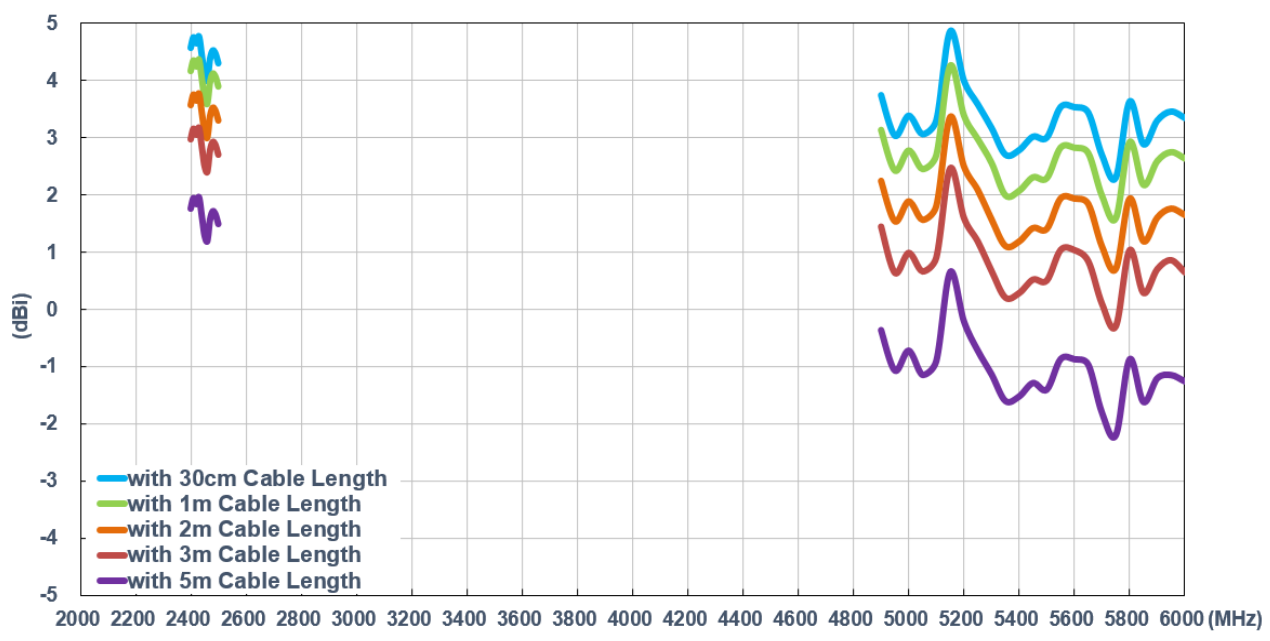

7.2.9 Peak Gain (Wi-Fi MIMO 2)

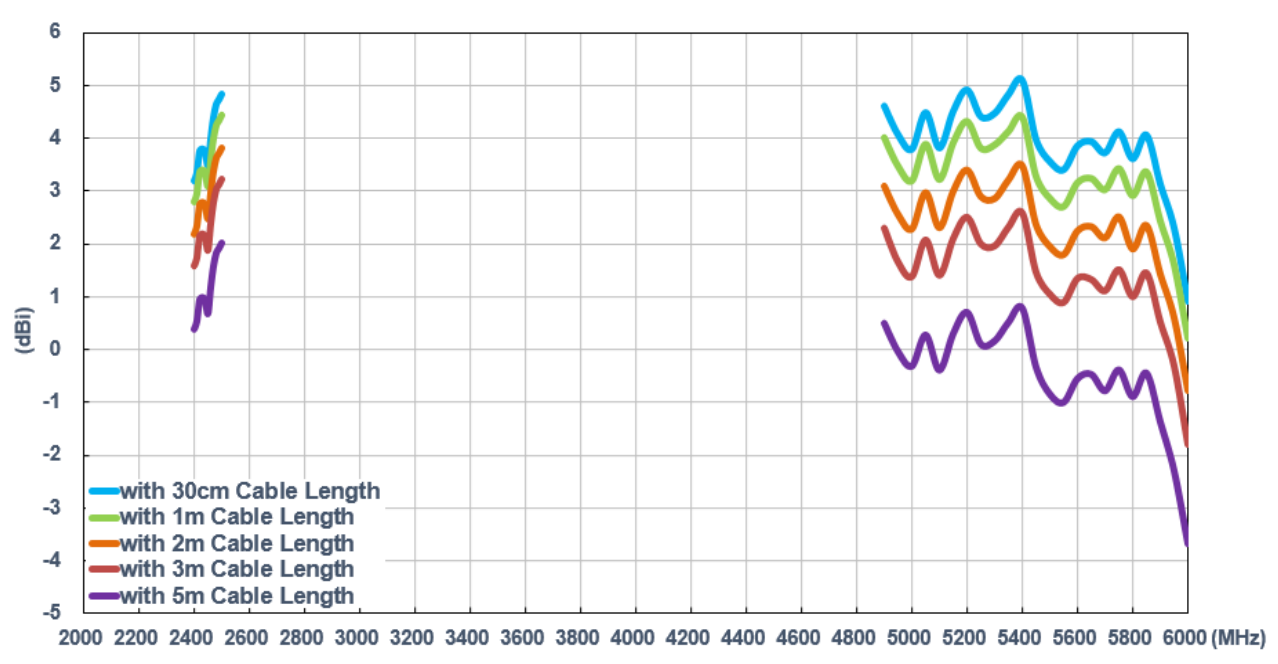

8. Installation Instructions

Introduction

Following these guidelines will help ensure that your Taoglas Guardian antenna is installed correctly. The Guardian is simply mounted via a wall mount bracket, details outlined below.



Electrical Safety

The Pantheon contain an active GPS/GNSS antenna.
Rated voltage: 3-5VDC Rated current: 20mA maximum

The supply to this device must be provided with overcurrent protection of 1A maximum.

Power consumption@1.8V (mA) 8.7 mA

Power consumption@3.0V (mA) 9.0 mA

Power consumption@5.5V (mA) 11 mA

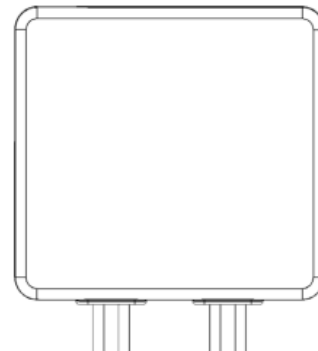

Installation Requirements

Antenna Components:

- Antenna Enclosure x 1
- Mounting Bracket x1
- Screws x2
- Rawl Plugs x2

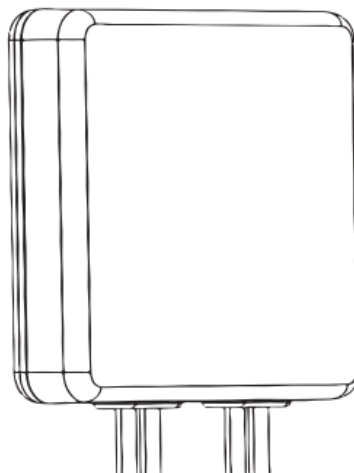
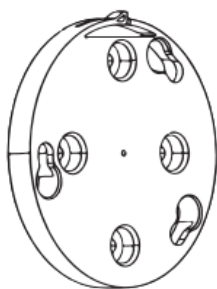

Tools Required:

Screwdriver, drill, M4 [Gauge 8]

Wall Mount

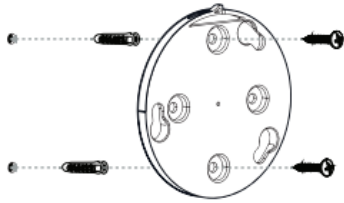

1. Using the mounting bracket as guide, mark the position of the wall screws to the desired location of the bracket. Drill holes for the wall mount studs (6mm [1/4"] diameter, min. 25mm [1"] depth) and secure the studs in place. Insert screws through the bracket holes and into the wall studs. Tighten the screw to secure the mounting bracket to the wall.

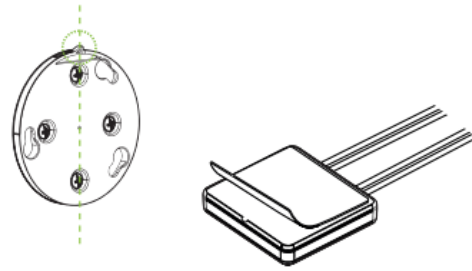

2. Connect the the back of the antenna to the brakcet via the 3 built-in mounting points on the rear of the antenna.
Note: The locking mechanism is highlighted in green.

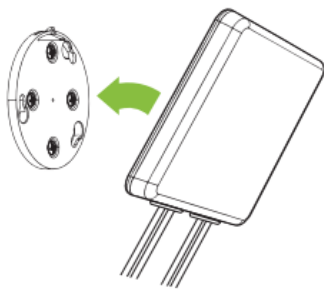

3. Press the antenna into the open area of the holes on the bracket via the mounting points.
Note: The antenna and bracket should be mounted level on the horizontal plane.

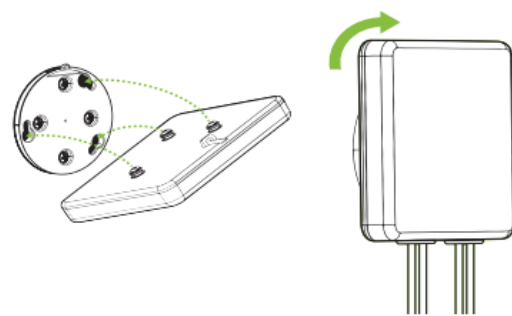

4. Rotate the Antenna in to the bracket by turning slightly. The locking mechanism on the bracket and back of the antenna should be connected together at the point.

5. Completed Installation of the .

Note: The bracket should be flush with antenna.

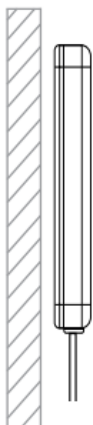

Notices



Caution

To comply with FCC RF Exposure requirements in section 1.1310 of the FCC Rules, antennas used with this device must be installed to provide a separation distance of at least 20 cm from all persons to satisfy RF exposure compliance.



Warning

Do not Operate the transmitter when someone is within 20 cm of the antenna.
Do not operate the equipment in an explosive atmosphere.



European Waste Electronic Equipment Directive 2002/96/EC

Please ensure that your old Waste Electricals and Electronics are recycled do not throw them away into standard waste.

Waiver: This document represents information compiled by Taoglas to the best of our current knowledge. This is not intended to be used as a representation or warranty of fitness of the products described for any particular purpose. This document details guidelines for general information purposes only. When planning installations, always seek specialist advice and ensure that the products are always installed by a properly qualified installer in accordance with applicable regional laws and regulations.

All copyrights, trademarks and any other intellectual property rights related are owned by Taoglas Group Holdings Limited.

Changelog for the datasheet

SPE-18-8-022 – MA961.A.BICG.002.wm

Revision: C (Current Versions)

| | |
|---------|-----------------------------------|
| Date: | 2023-07-21 |
| Notes: | Updated Installation Instructions |
| Author: | Cesar Sousa |

Previous Revisions

Revision: B

| | |
|---------|------------------------------------|
| Date: | 2022-08-08 |
| Notes: | Updated Drawing and specifications |
| Author: | Cesar Sousa |

Revision: A (Original First Release)

| | |
|---------|---------------------------|
| Date: | 2018-01-19 |
| Notes: | Initial Datasheet Release |
| Author: | Author |



www.taoglas.com

