



TAOGLAS®



Datasheet

5G/4G Terminal Mount Monopole Antenna

Part No:
TG.55.8113W

Description

5G/4G Terminal Mount Monopole Antenna with 90° Hinged SMA (M) Connector

Features:

- Covering Sub 6GHz 5G NR Bands
- Covering Worldwide 4G Bands
- 600MHz-6GHz Bandwidth
- High Efficiency up to 80%
- 3G/2G Fallback with NB-IoT and CAT-M capabilities
- 90° Hinged Right Angle SMA (M) Connector
- Straight Dimensions: 172 x 23.9 x 13 mm
- Right Angle Dimensions: 148 x 42.4 x 13 mm
- RoHS & REACH Compliant

1.	Introduction	3
2.	Specification	4
3.	Antenna Characteristics	7
4.	Radiation Patterns	10
5.	Mechanical Drawing	55
6.	Packaging	56
<hr/>		
	Changelog	57

Taoglas makes no warranties based on the accuracy or completeness of the contents of this document and reserves the right to make changes to specifications and product descriptions at any time without notice. Taoglas reserves all rights to this document and the information contained herein. Reproduction, use or disclosure to third parties without express permission is strictly prohibited.



1. Introduction



The Taoglas TG.55.8113W is a 5G/4G monopole antenna, designed primarily for use with modules and devices that require high efficiency and peak gain. It delivers best in class throughput on all major cellular bands worldwide, perfect for access points, terminals, and routers. The TG.55 covers many 5G NR Sub 6GHz bands including the new Extended LTE Band 71. It has an SMA (M) connector as standard and is an ideal solution for any device requiring reliable performance in a slim form factor.

Typical Applications include:

- Gateways & Routers
- Industrial IoT
- Smart Metering
- Smart Home
- Vending Machines
- Connected Enterprise

The TG.55 exhibits an efficiency of up to 80% across wideband 5G/4G bands and is backward compatible with 3G/2G cellular applications. The TG.55 is a fully omnidirectional antenna as seen in the radiation patterns and is stable across all bands. The SMA (M) connector hinge mechanism allows the antenna to be rotated into the preferred orientation which helps to avoid other antennas or objects. This also helps with isolation by pointing the antennas in different directions when used in MIMO systems or when other antennas are present on the same device. The antenna blade can swivel 90 degrees from the connector accommodating different installation configurations.

The TG.55.8113W is also available with a black enclosure, [TG.55.8113](#). The connector is also available in FAKRA Code D, [TG.55.8723](#) but can be customized based on an MOQ.

Contact your regional Taoglas customer support team to request these services or additional support to integrate and test this antenna's performance in your device.

2. Specification

Band	Frequency (MHz)	Measurement	Efficiency (%)	Average Gain (dB)	Peak Gain (dBi)	Impedance	Polarization	Radiation Pattern	Max. input power
5G NR/4G Band 71	617-698	Bent in Free Space	51.5	-2.88	1.47	50 Ω	Linear	Omni	2W
		Bent on a 9x15cm Ground Plane	17.0	-7.69	-3.62				
		Straight in Free Space	50.3	-2.99	2.44				
		Straight on a 9x15cm Ground Plane	17.7	-7.52	-3.10				
LTE 700	698-824	Bent in Free Space	43.7	-3.60	1.08				
		Bent on a 9x15cm Ground Plane	26.6	-5.74	-1.46				
		Straight in Free Space	47.7	-3.21	2.65				
		Straight on a 9x15cm Ground Plane	25.8	-5.88	0.45				
GSM 850/90	824-960	Bent in Free Space	50.8	-2.94	3.33				
		Bent on a 9x15cm Ground Plane	57.2	-2.42	1.12				
		Straight in Free Space	52.2	-2.82	3.37				
		Straight on a 9x15cm Ground Plane	54.5	-2.64	2.48				
5G NR/4G Band 21,32,74,75,76	1427-1518	Bent in Free Space	55.0	-2.60	2.26				
		Bent on a 9x15cm Ground Plane	64.3	-1.92	2.00				
		Straight in Free Space	54.7	-2.62	4.14				
		Straight on a 9x15cm Ground Plane	63.6	-1.96	3.50				
GNSS E1/B1/G1/L1	1559-1610	Bent in Free Space	69.6	-1.57	2.25				
		Bent on a 9x15cm Ground Plane	78.6	-1.05	2.95				
		Straight in Free Space	69.0	-1.61	3.02				
		Straight on a 9x15cm Ground Plane	79.0	-1.03	3.64				
DCS	1710-1880	Bent in Free Space	87.4	-0.58	3.99				
		Bent on a 9x15cm Ground Plane	84.4	-0.74	3.11				
		Straight in Free Space	84.2	-0.75	3.38				
		Straight on a 9x15cm Ground Plane	75.4	-1.23	2.93				
UMTS1	1920-2170	Bent in Free Space	78.3	-1.06	3.12				
		Bent on a 9x15cm Ground Plane	75.1	-1.25	2.81				
		Straight in Free Space	74.6	-1.27	3.64				
		Straight on a 9x15cm Ground Plane	74.1	-1.30	4.43				
LTE 2600	2300-2690	Bent in Free Space	68.4	-1.65	3.37				
		Bent on a 9x15cm Ground Plane	66.4	-1.78	2.85				
		Straight in Free Space	68.4	-1.65	4.89				
		Straight on a 9x15cm Ground Plane	66.2	-1.79	4.36				
5G NR B 77,78,79	3300-5000	Bent in Free Space	79.4	-1.00	5.00				
		Bent on a 9x15cm Ground Plane	74.0	-1.31	5.39				
		Straight in Free Space	82.9	-0.82	4.75				
		Straight on a 9x15cm Ground Plane	75.6	-1.21	4.96				
LTE 5200	5150-5925	Bent in Free Space	62.8	-2.02	5.23				
		Bent on a 9x15cm Ground Plane	56.3	-2.49	4.76				
		Straight in Free Space	60.1	-2.21	4.06				
		Straight on a 9x15cm Ground Plane	58.5	-2.33	4.52				

5G/4G Bands						
Band Number	5G NR / FR1 / LTE / LTE-Advanced / WCDMA / HSPA / HSPA+ / TD-SCDMA					
	Uplink	Downlink	Bent in Free Space	Bent on a 9x15cm Ground Plane	Straight in Free Space	Straight on a 9x15cm Ground Plane
B1	1920 to 1980	2110 to 2170	✓	✓	✓	✓
B2	1850 to 1910	1930 to 1990	✓	✓	✓	✓
B3	1710 to 1785	1805 to 1880	✓	✓	✓	✓
B4	1710 to 1755	2110 to 2155	✓	✓	✓	✓
B5	824 to 849	869 to 894	✓	✓	✓	✓
B7	2500 to 2570	2620 to 2690	✓	✓	✓	✓
B8	880 to 915	925 to 960	✓	✓	✓	✓
B9*	1749.9 to 1784.9	1844.9 to 1879.9	✓	✓	✓	✓
B11	1427.9 to 1447.9	1475.9 to 1495.9	✓	✓	✓	✓
B12	699 to 716	729 to 746	✓	✓	✓	✓
B13	777 to 787	746 to 756	✓	✓	✓	✓
B14	788 to 798	758 to 768	✓	✓	✓	✓
B17	704 to 716	734 to 746	✓	✓	✓	✓
B18	815 to 830	860 to 875	✓	✓	✓	✓
B19	830 to 845	875 to 890	✓	✓	✓	✓
B20	832 to 862	791 to 821	✓	✓	✓	✓
B21	1447.9 to 1462.9	1495.9 to 1510.9	✓	✓	✓	✓
B22*	3410 to 3490	3510 to 3590	✓	✓	✓	✓
B23*	2000 to 2020	2180 to 2200	✓	✓	✓	✓
B24	1626.5 to 1660.5	1525 to 1559	✓	✓	✓	✓
B25	1850 to 1915	1930 to 1995	✓	✓	✓	✓
B26	814 to 849	859 to 894	✓	✓	✓	✓
B27*	807 to 824	852 to 869	✓	✓	✓	✓
B28	703 to 748	758 to 803	✓	✓	✓	✓
B29		717 to 728	✓	✓	✓	✓
B30	2305 to 2315	2350 to 2360	✓	✓	✓	✓
B31	452.5 to 457.5	462.5 to 467.5	*	*	*	*
B32		1452 to 1496	✓	✓	✓	✓
B34		2010 to 2025	✓	✓	✓	✓
B35		1850 to 1910	✓	✓	✓	✓
B36		1930 to 1990	✓	✓	✓	✓
B37		1910 to 1930	✓	✓	✓	✓
B38		2570 to 2620	✓	✓	✓	✓
B39		1880 to 1920	✓	✓	✓	✓
B40		2300 to 2400	✓	✓	✓	✓
B41		2496 to 2690	✓	✓	✓	✓
B42		3400 to 3600	✓	✓	✓	✓
B43		3600 to 3800	✓	✓	✓	✓
B45		1447 to 1467	✓	✓	✓	✓
B46		5150 to 5925	✓	✓	✓	✓
B47		5855 to 5925	✓	✓	✓	✓
B48		3550 to 3700	✓	✓	✓	✓
B49		3550 to 3700	✓	✓	✓	✓
B50		1432 to 1517	✓	✓	✓	✓
B51		1427 to 1432	✓	✓	✓	✓
B52		3300 to 3400	✓	✓	✓	✓
B53		2483.5 to 2495	✓	✓	✓	✓
B65	1920 to 2010	2110 to 2200	✓	✓	✓	✓
B66	1710 to 1780	2110 to 2200	✓	✓	✓	✓
B68	698 to 728	753 to 783	✓	✓	✓	✓
B69		2570 to 2620	✓	✓	✓	✓
B70	1695 to 1710	1995 to 2020	✓	✓	✓	✓
B71	663 to 698	617 to 652	✓	✓	✓	✓
B72	451 to 456	461 to 466	*	*	*	*
B73	450 to 455	460 to 465	*	*	*	*
B74	1427 to 1470	1475 to 1518	✓	✓	✓	✓
B75		1432 to 1517	✓	✓	✓	✓
B76		1427 to 1432	✓	✓	✓	✓
B77		3300 to 4200	✓	✓	✓	✓
B78		3300 to 3800	✓	✓	✓	✓
B79		4400 to 5000	✓	✓	✓	✓
B85	698 to 716	728 to 746	✓	✓	✓	✓
B87	410 to 415	420 to 425	*	*	*	*
B88	412 to 417	422 to 427	*	*	*	*

Mechanical

SMA Connector Diameter	13mm
Planner Dimension	172mm * 23.88mm
Casing	ABS + PC (White)
Connector	SMA (M)
Weight	24.3g

Environmental

Operation Temperature	-40°C to 85°C
Storage Temperature	-40°C to 85°C
Relative Humidity	Non-condensing 65°C 95% RH

3. Antenna Characteristics

3.1 Test Setup

AUT



Vector Network Analyzer

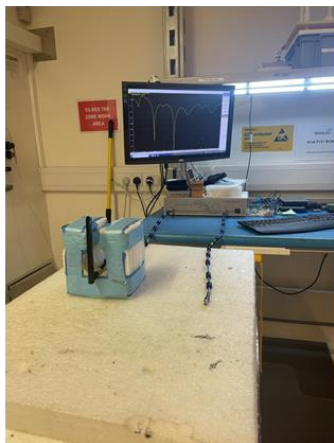

VNA Setup Bent in Free Space



VNA Setup Straight in Free Space

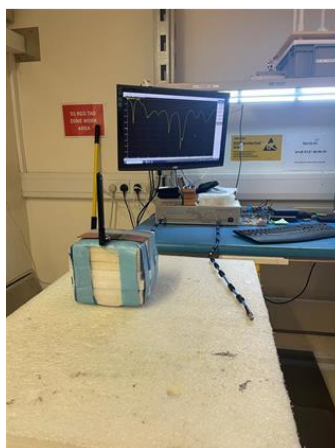

VNA Setup Bent on a 9x15cm Ground Plane

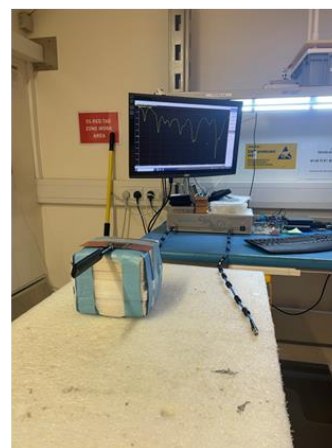

VNA Setup Straight on a 9x15cm Ground Plane

3.2 Return Loss

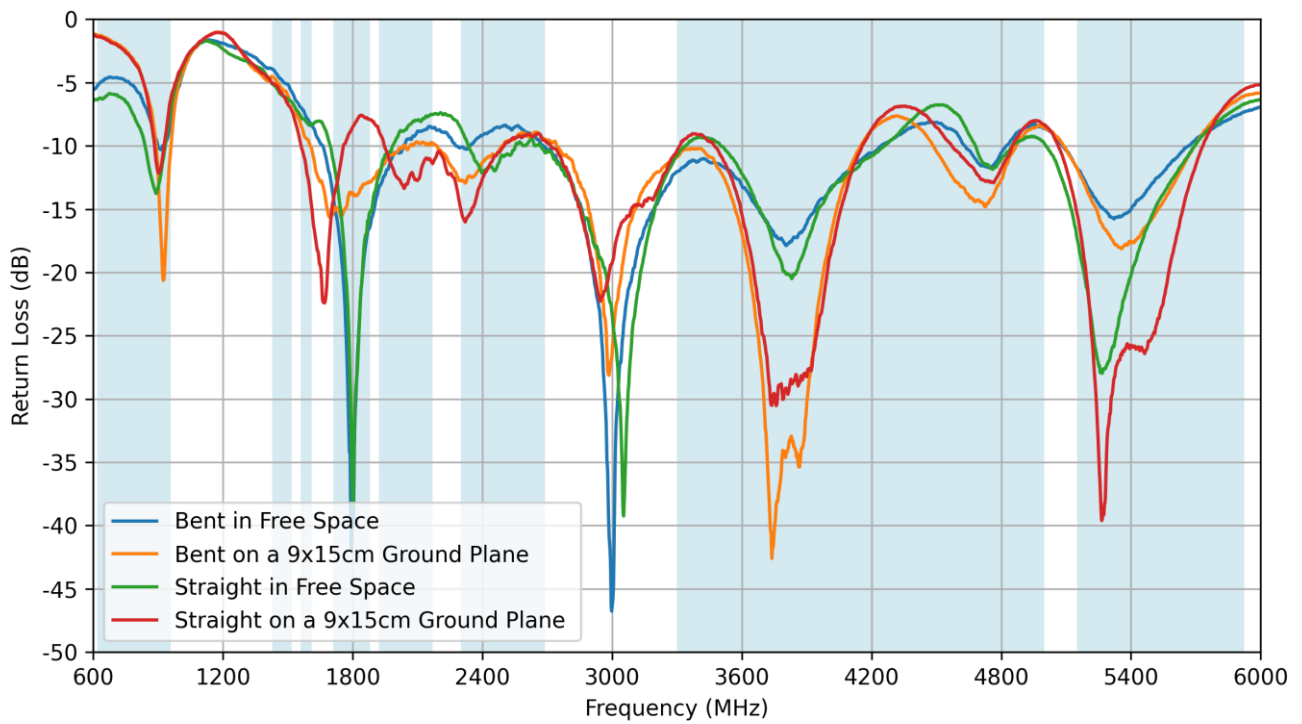

3.3 Efficiency

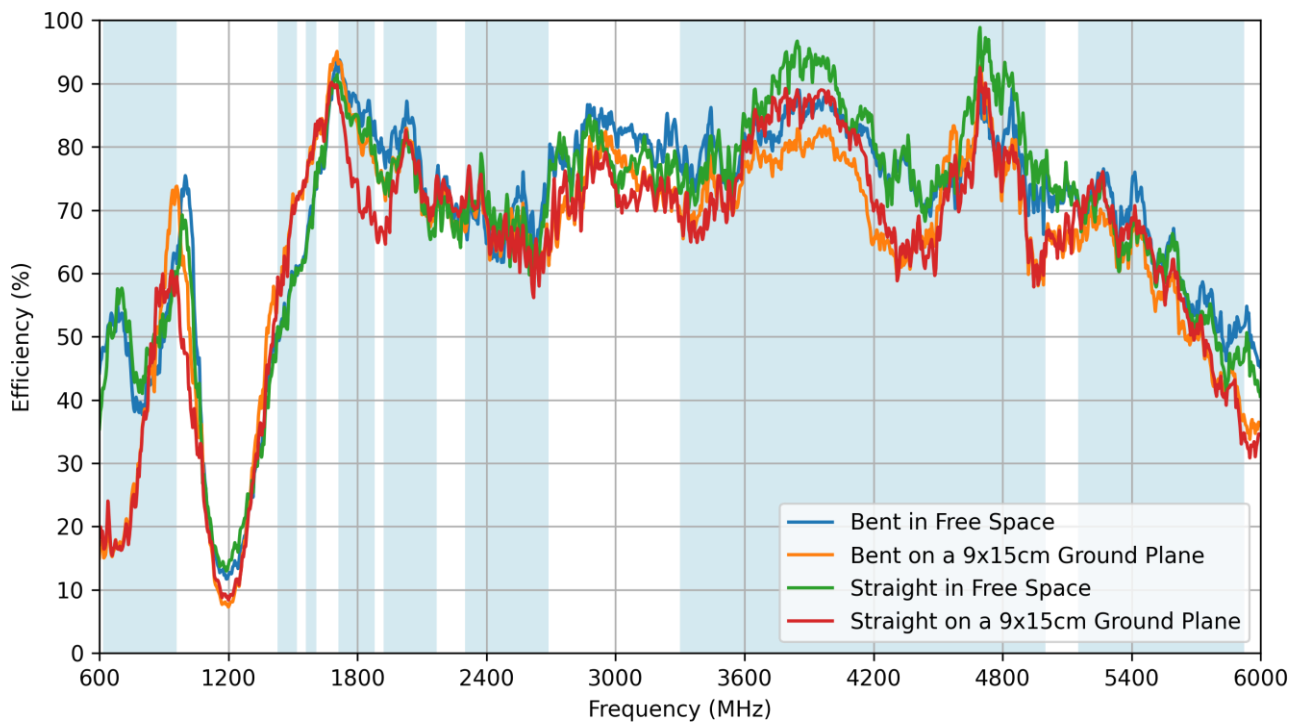

3.4 Average Gain

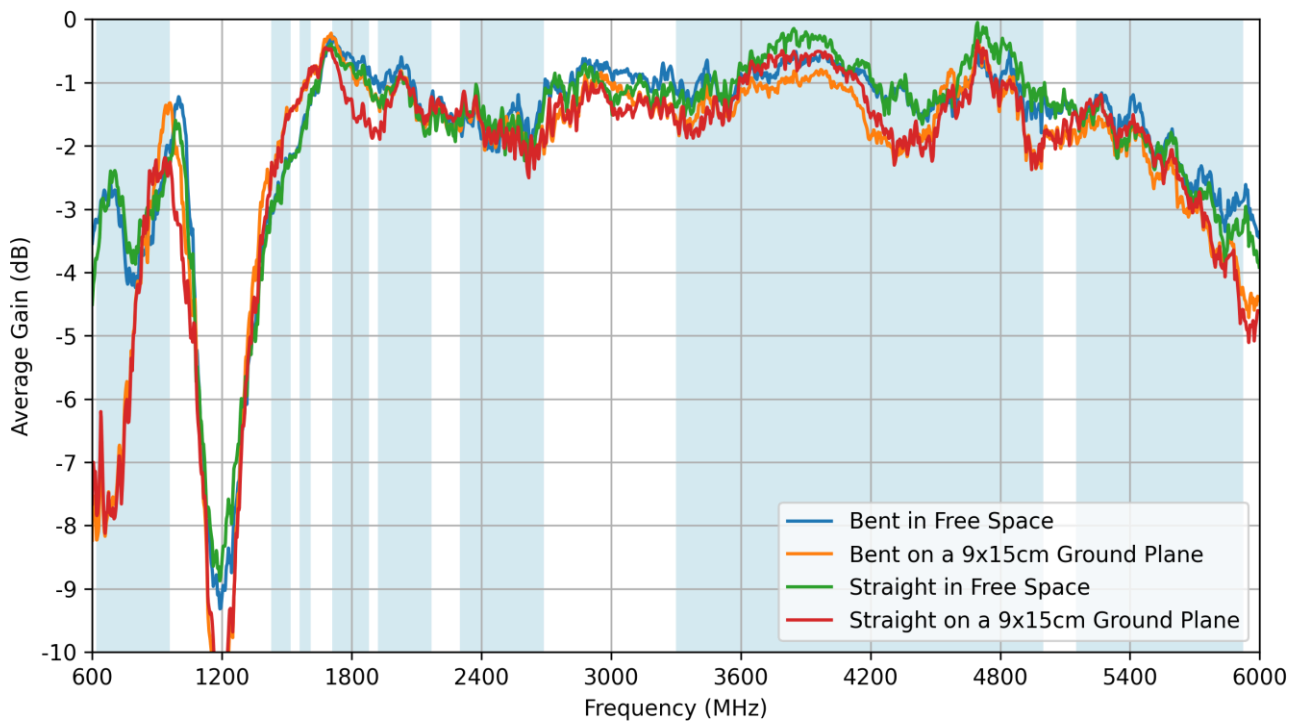

3.5 Peak Gain

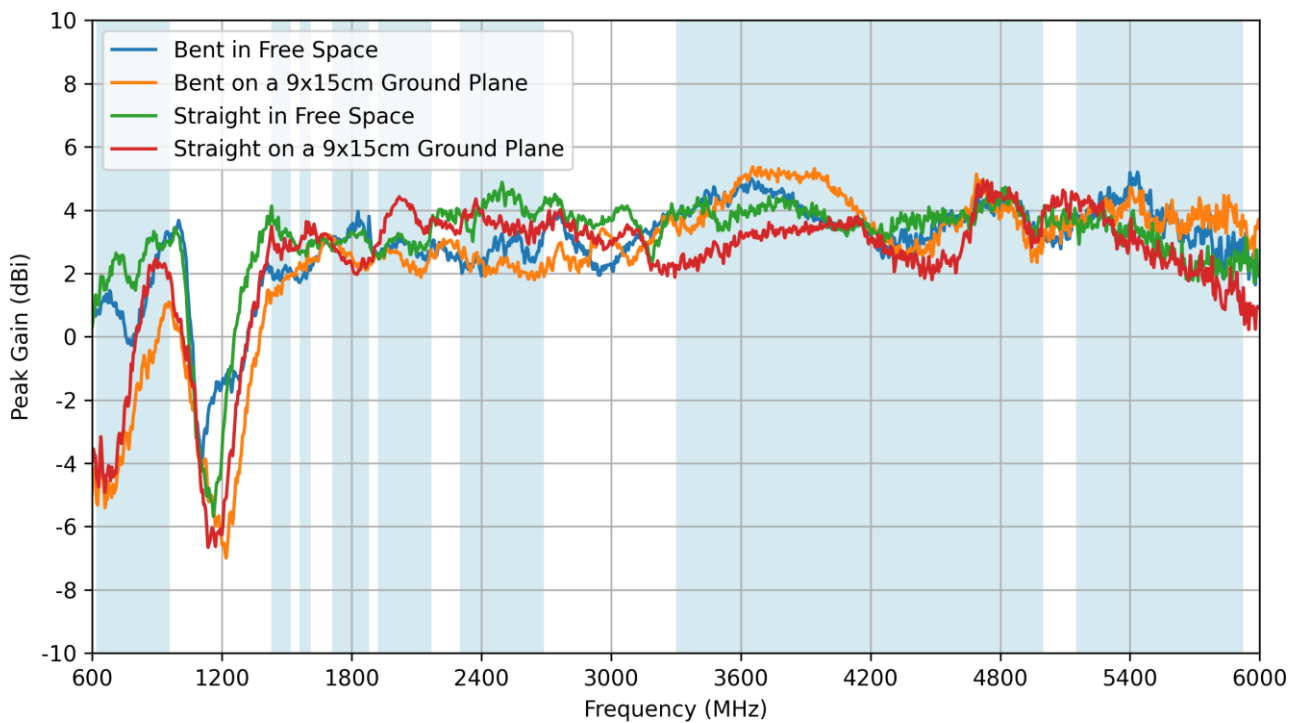

4. Radiation Patterns

4.1 Test Setup

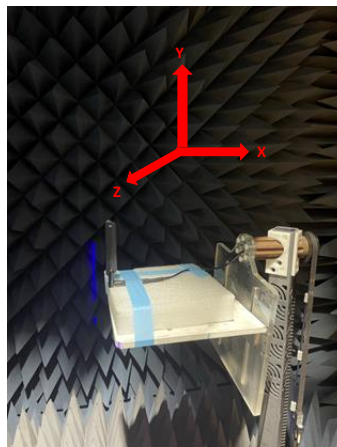
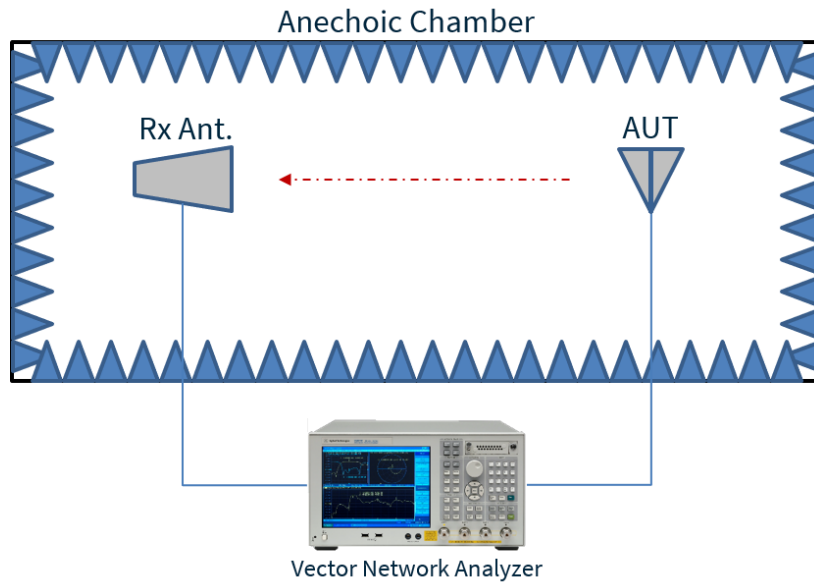

Chamber Setup Bent in Free Space

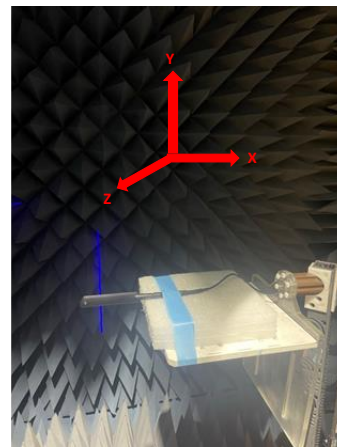

Chamber Setup Straight in Free Space

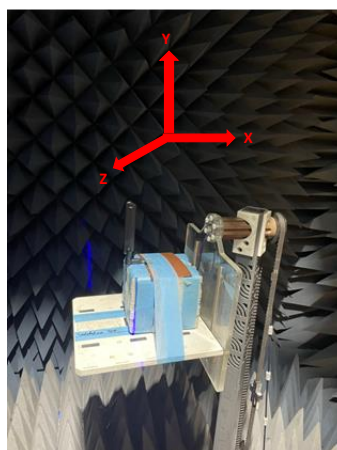

Chamber Setup Bent on a 9x15cm Ground Plane

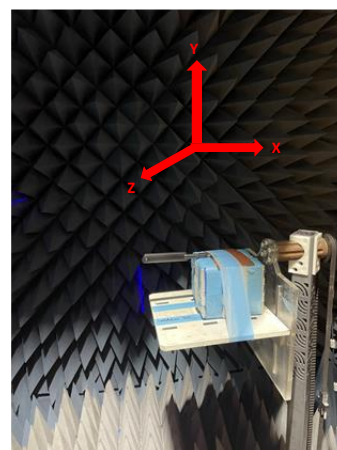

Chamber Setup Straight on a 9x15cm Ground Plane

4.2 Bent in Free Space Patterns at 650 MHz

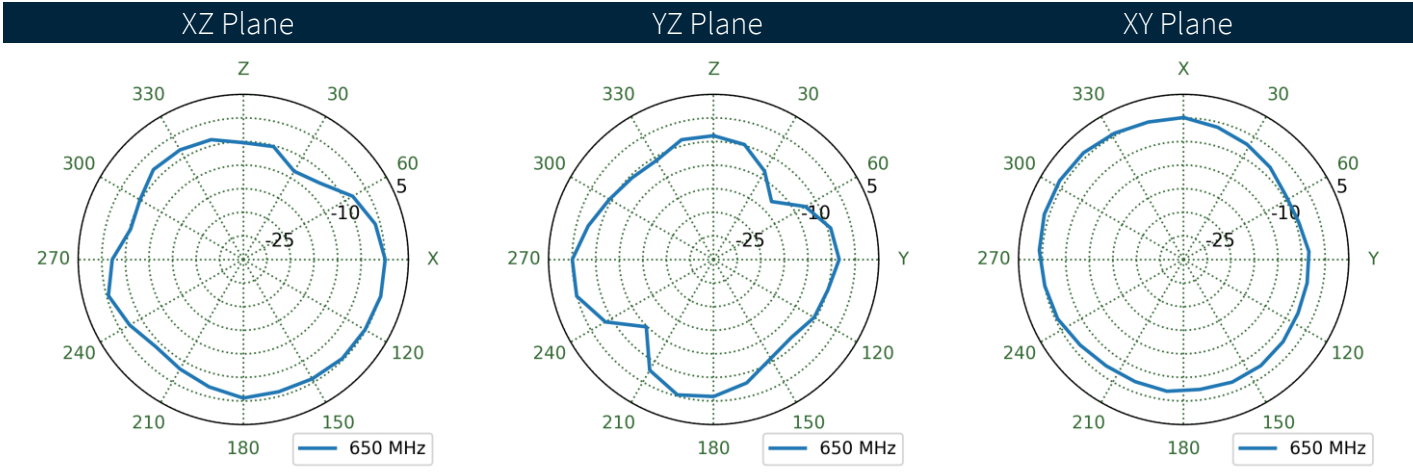
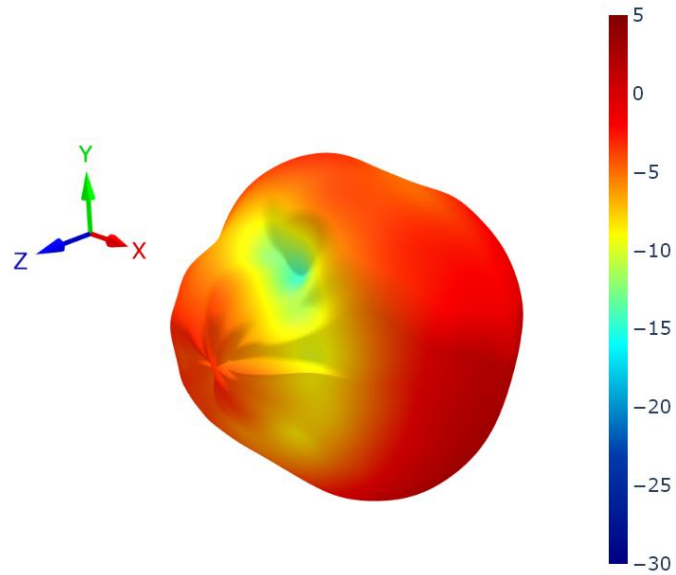

4.3 Bent on a 9x15cm Ground Plane Patterns at 650 MHz

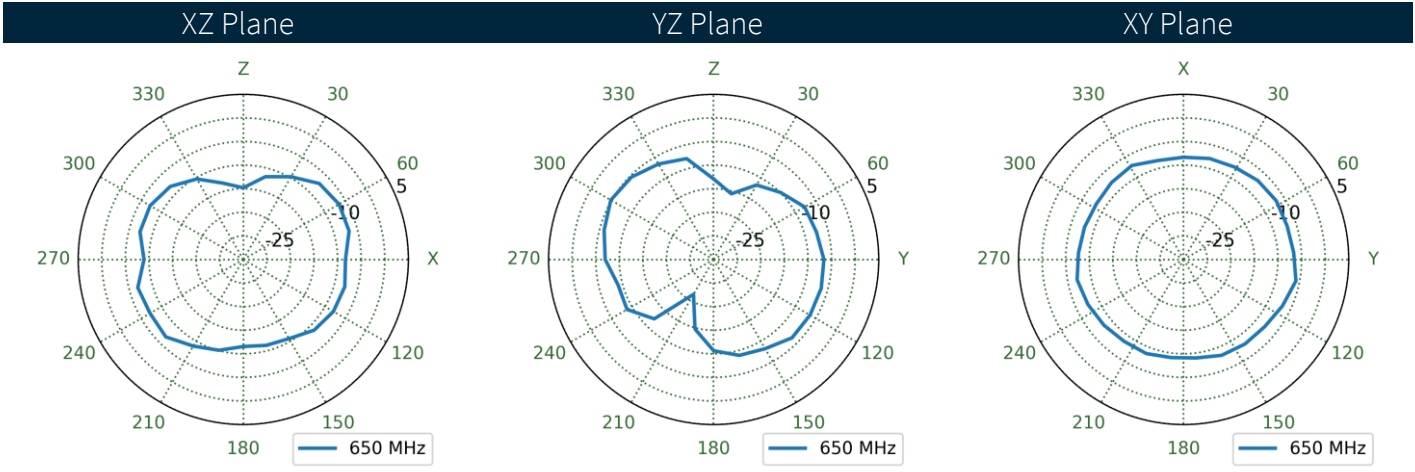
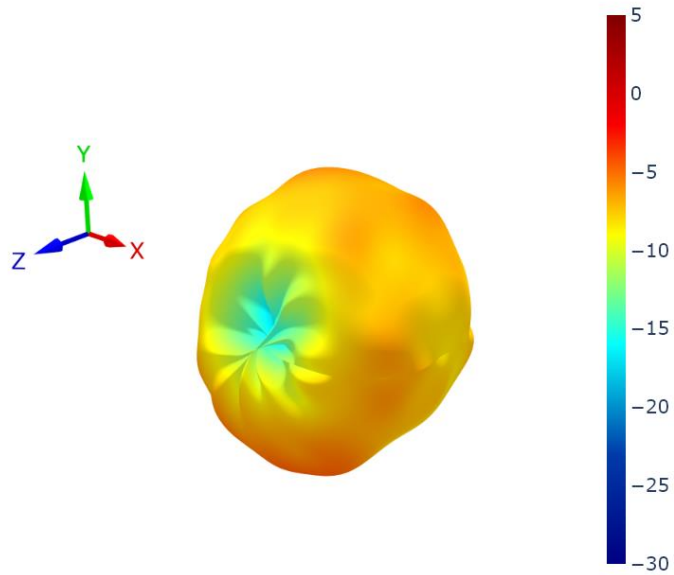

4.4 Straight in Free Space Patterns at 650 MHz

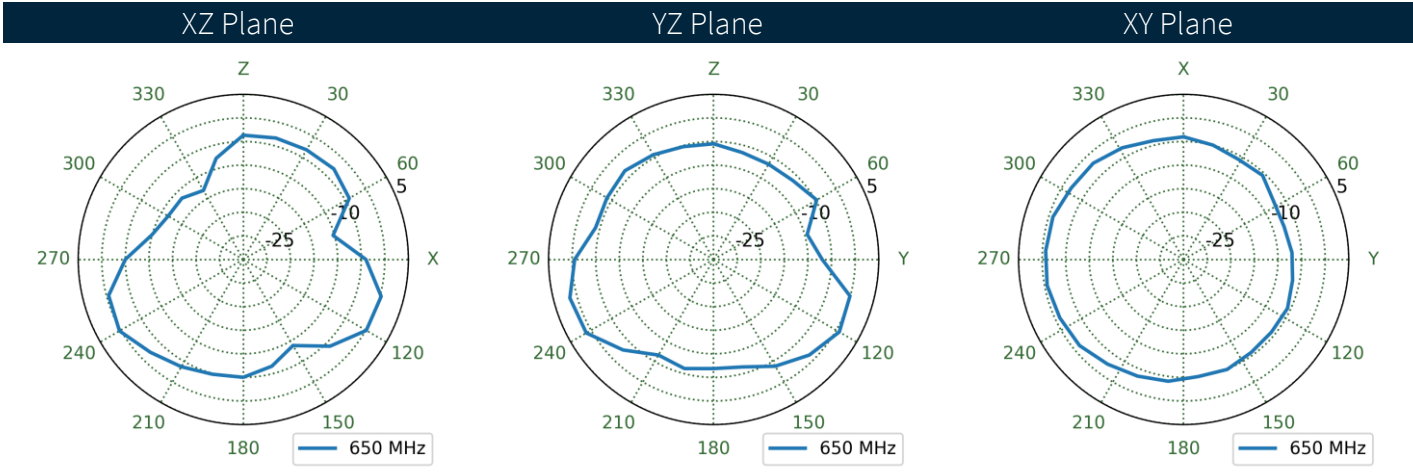
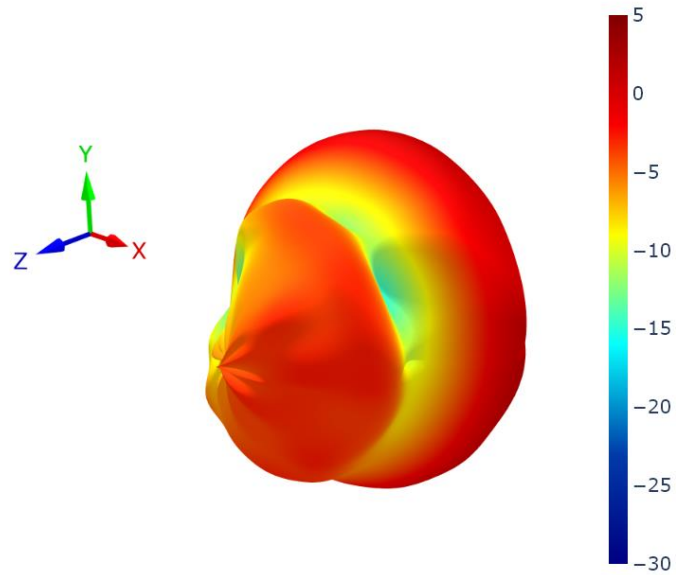

4.5 Straight on a 9x15cm Ground Plane Patterns at 650 MHz

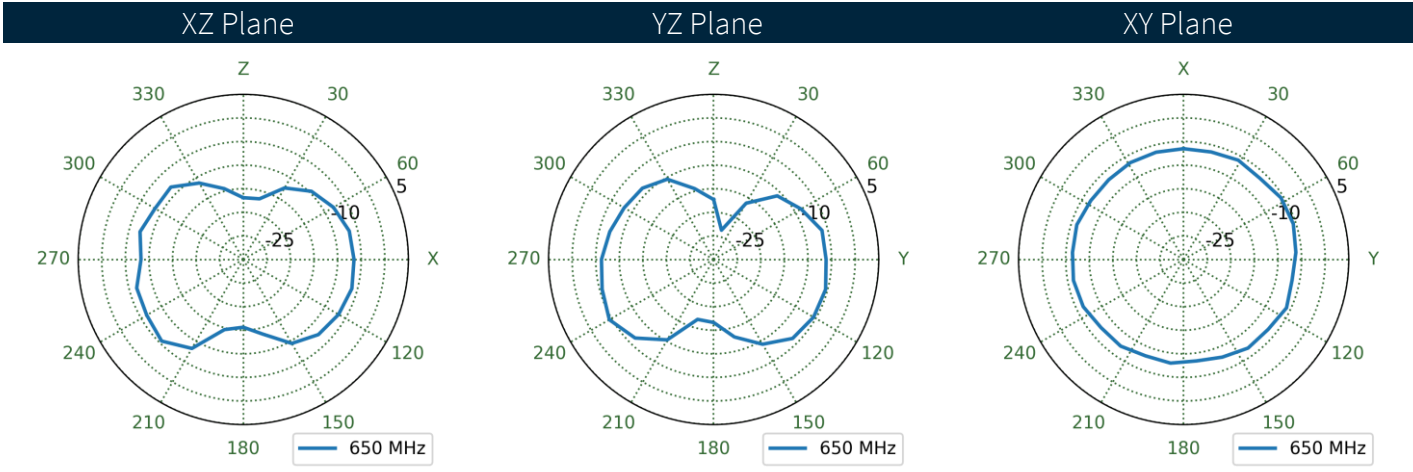
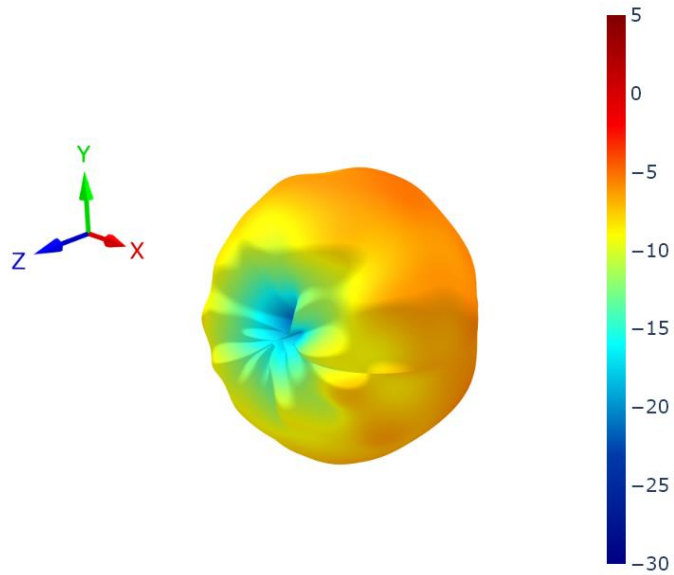

4.6 Bent in Free Space Patterns at 750 MHz

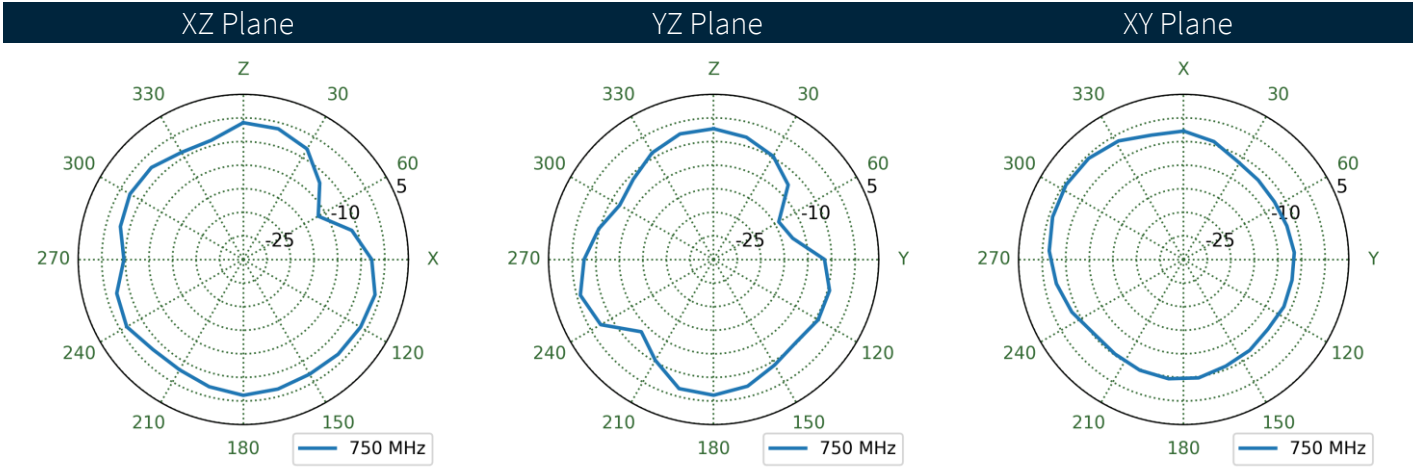
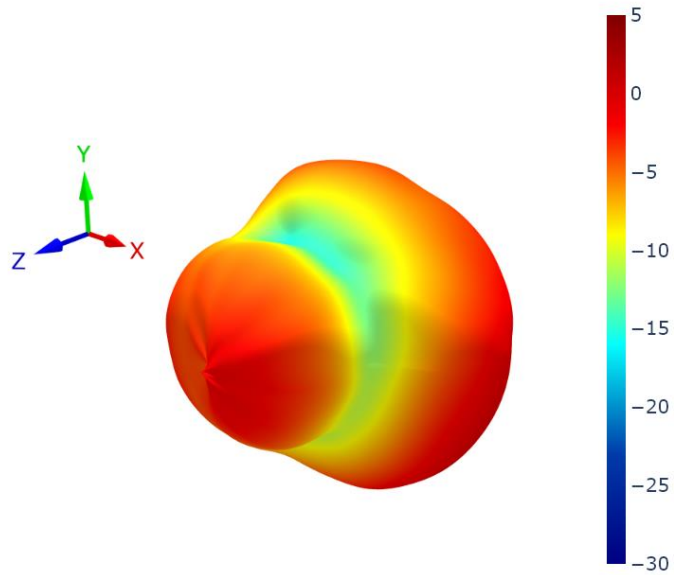

4.7 Bent on a 9x15cm Ground Plane Patterns at 750 MHz

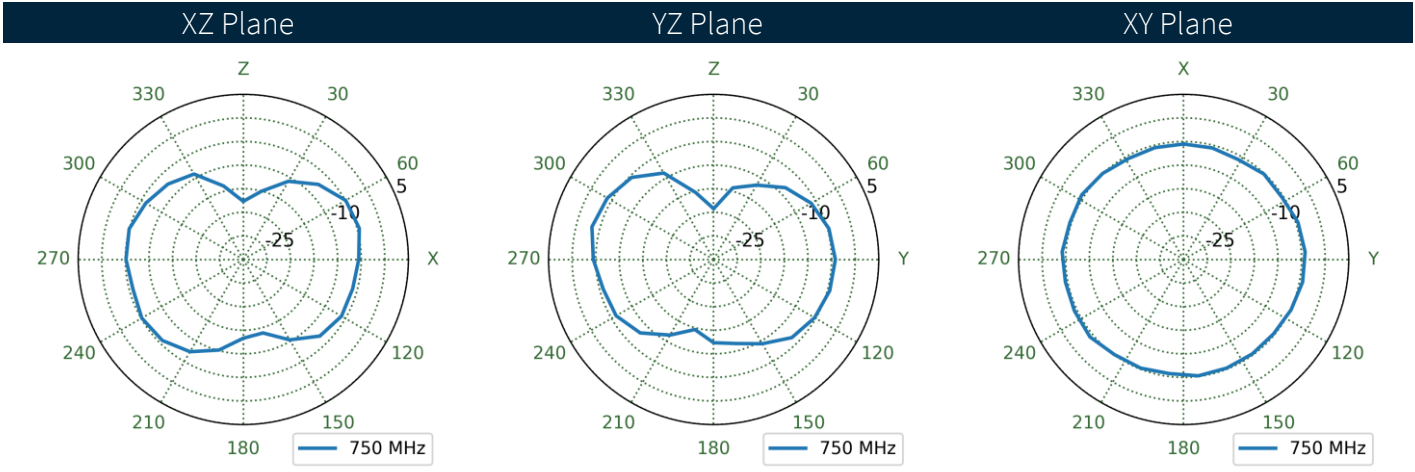
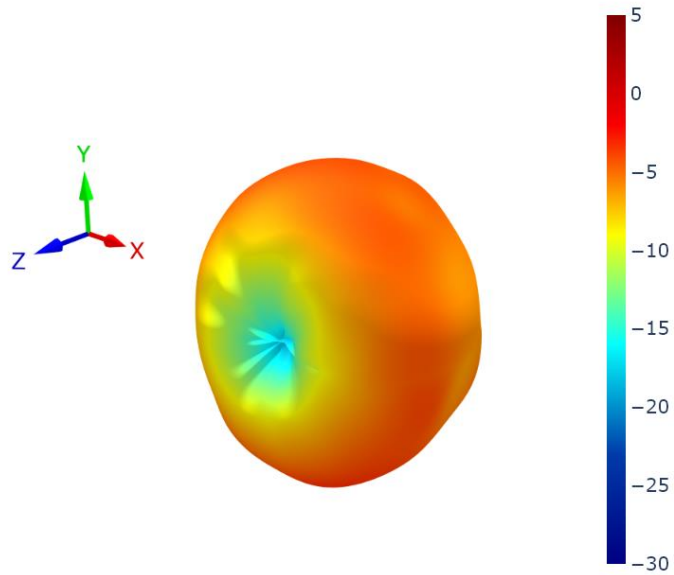

4.8 Straight in Free Space Patterns at 750 MHz

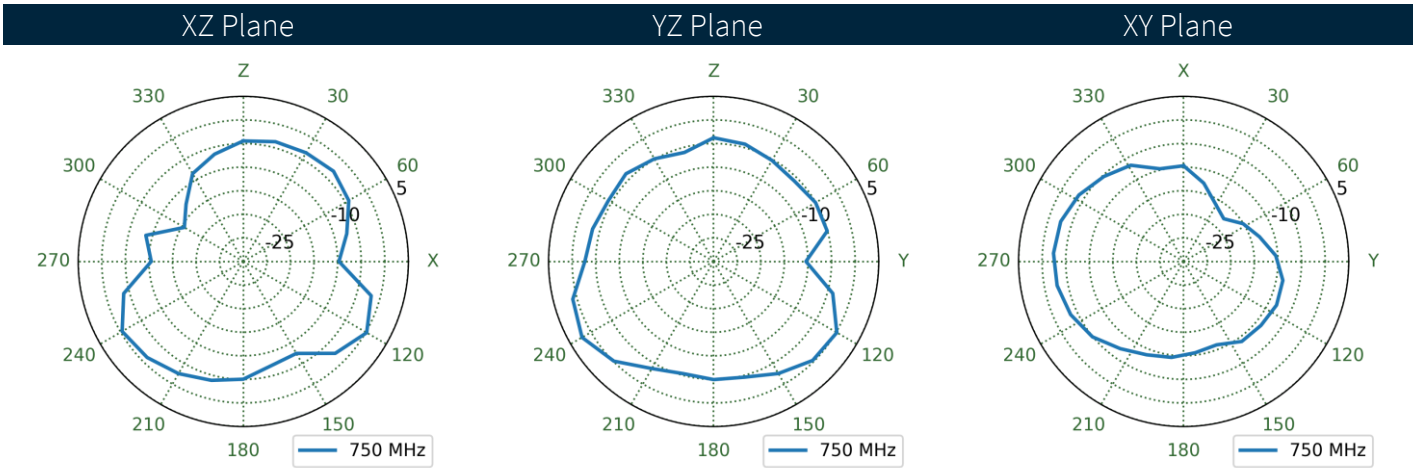
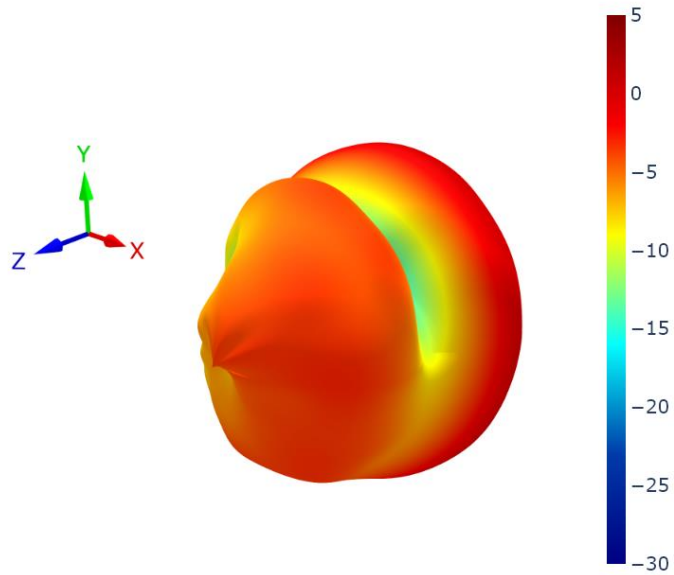

4.9 Straight on a 9x15cm Ground Plane Patterns at 750 MHz

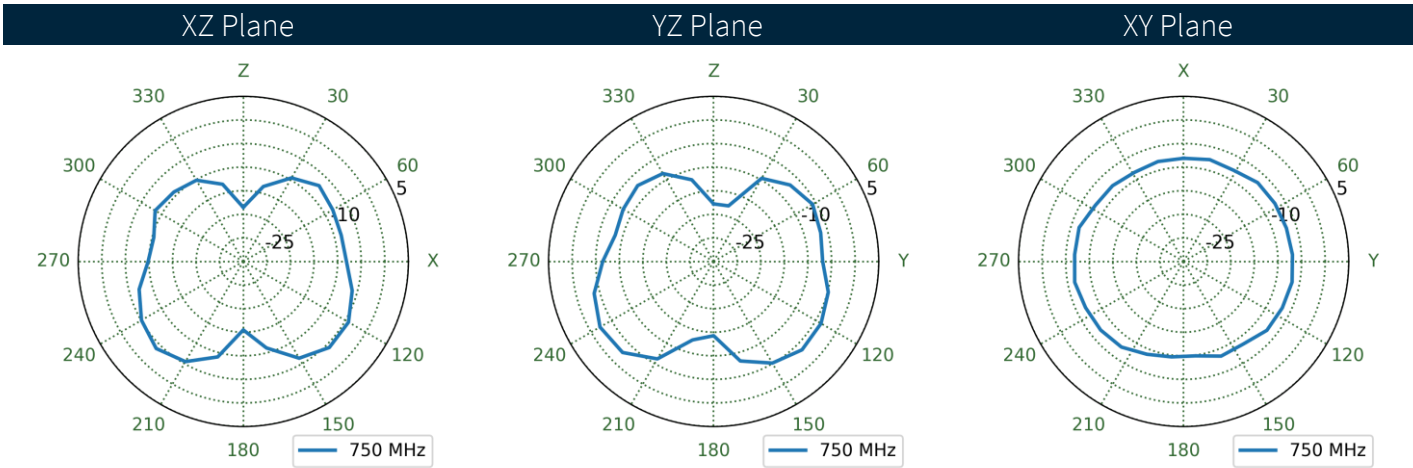
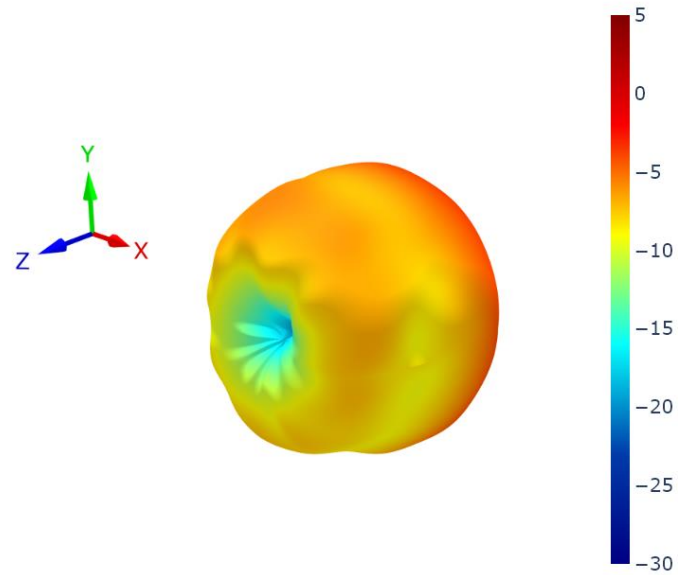

4.10 Bent in Free Space Patterns at 890 MHz

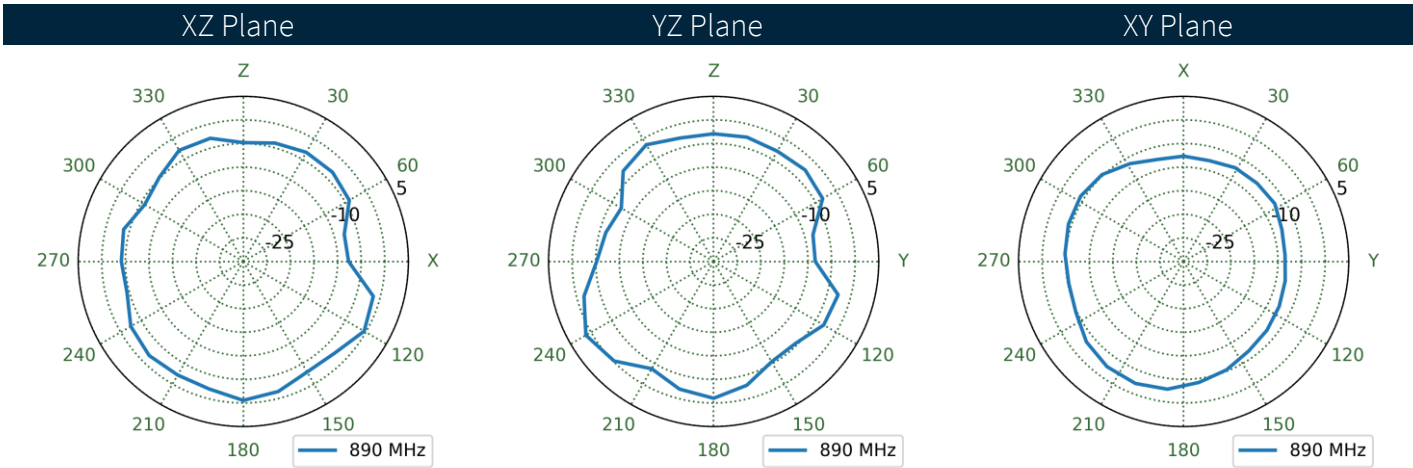
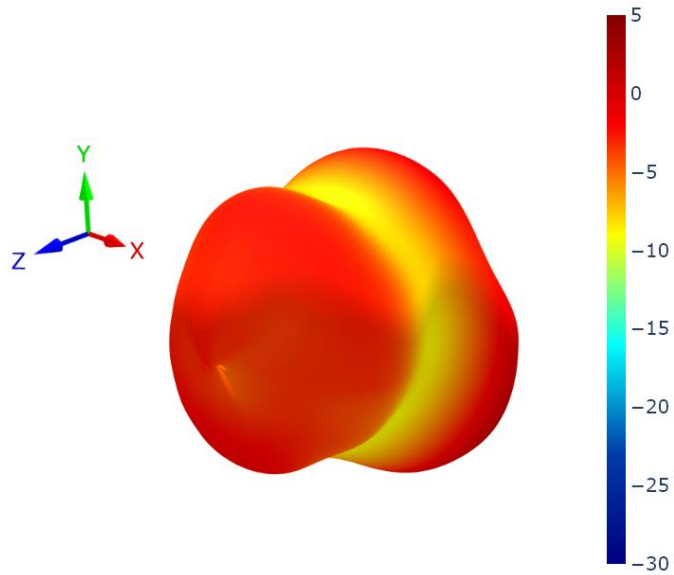

4.11 Bent on a 9x15cm Ground Plane Patterns at 890 MHz

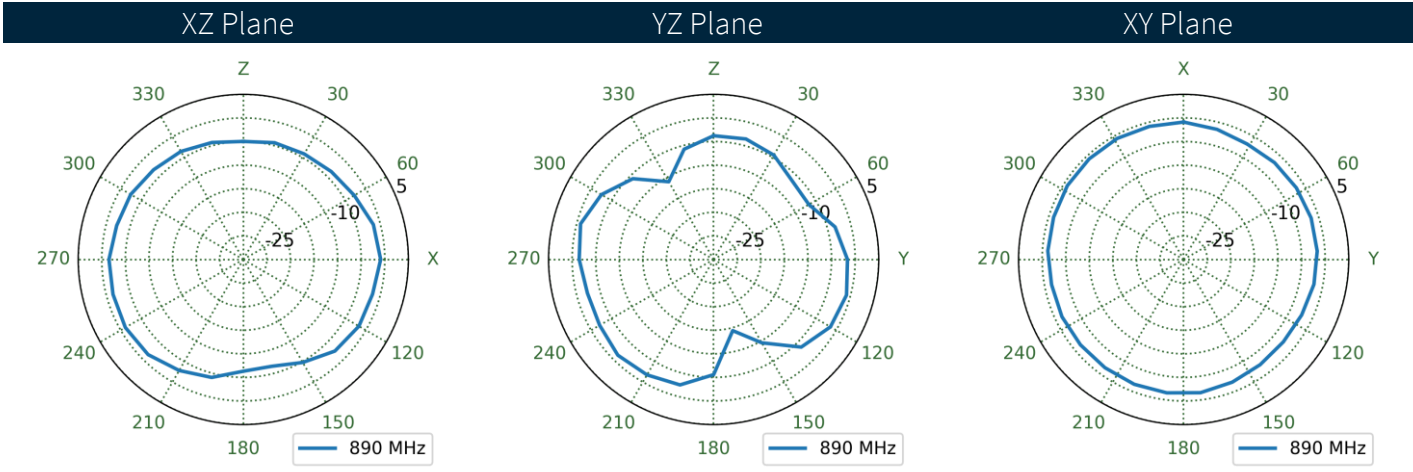
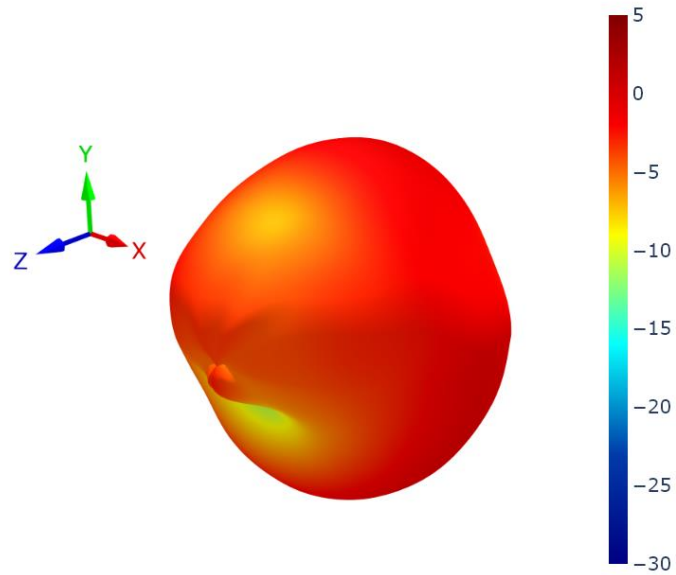

4.12 Straight in Free Space Patterns at 890 MHz

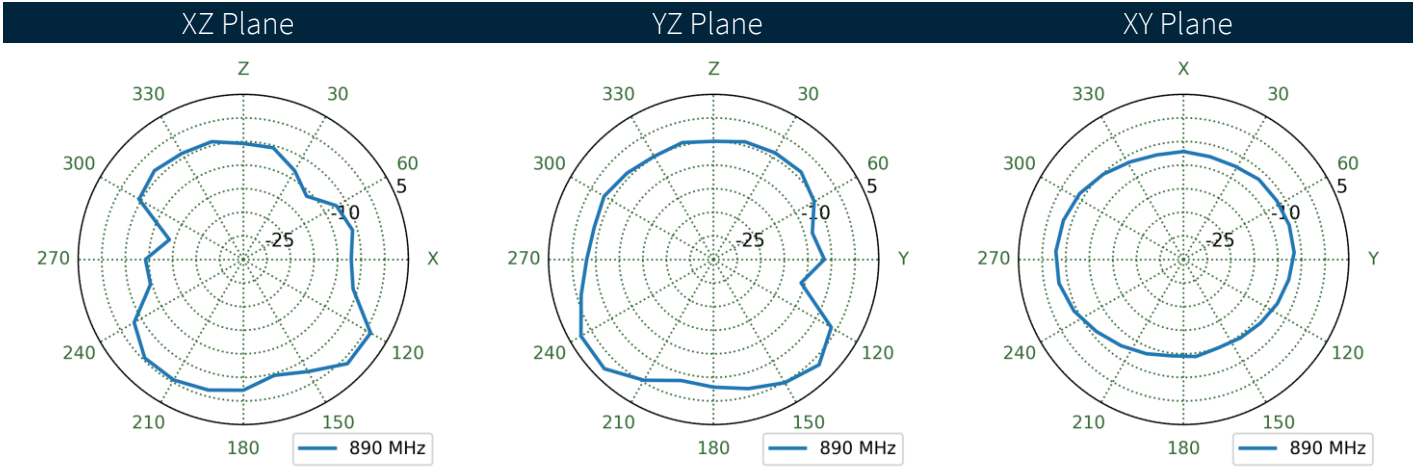
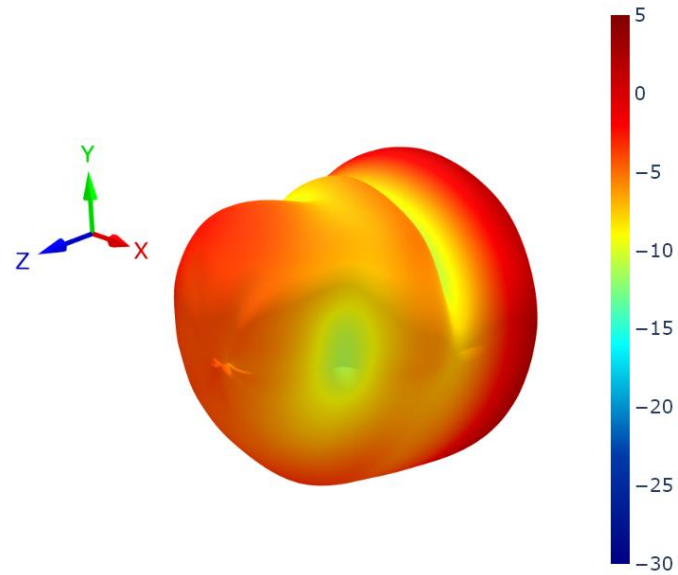

4.13 Straight on a 9x15cm Ground Plane Patterns at 890 MHz

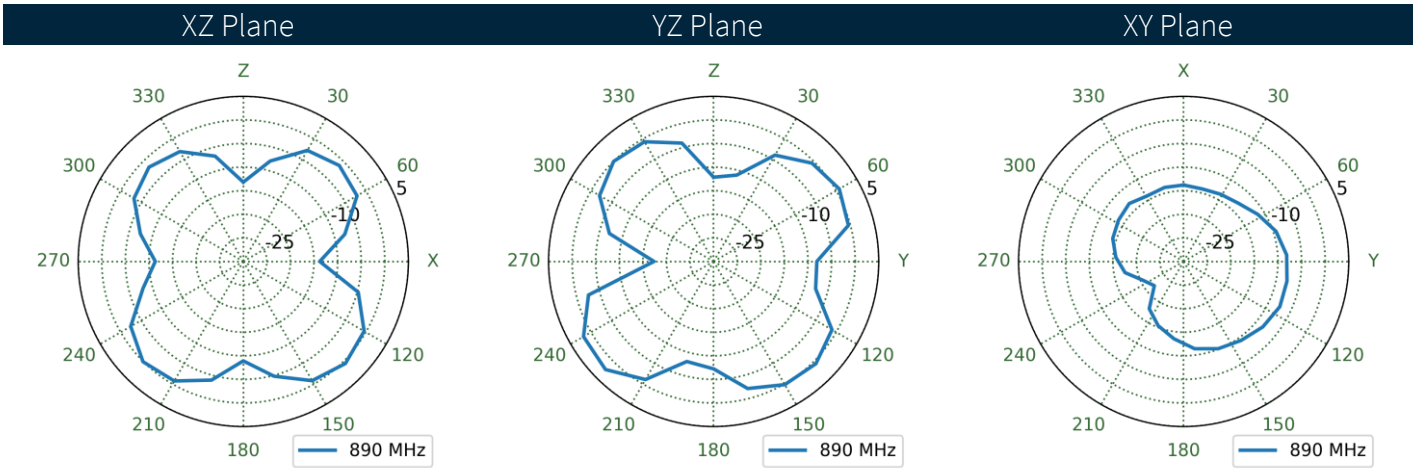
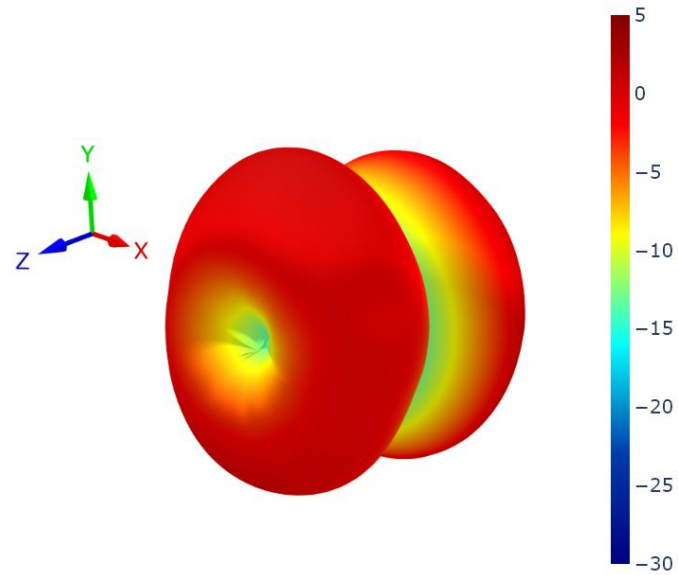

4.14 Bent in Free Space Patterns at 1470 MHz

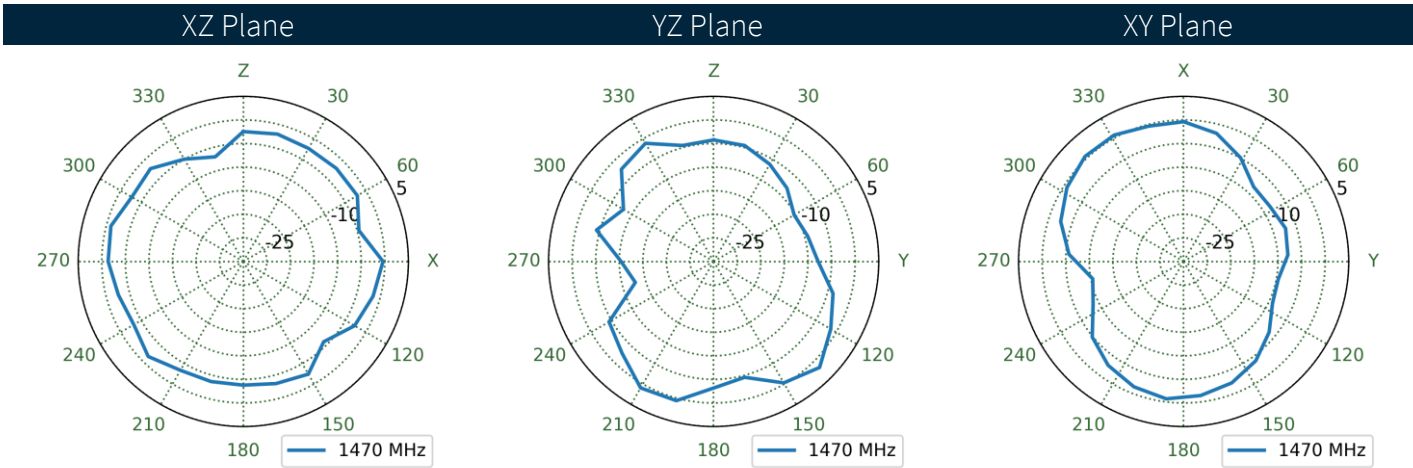
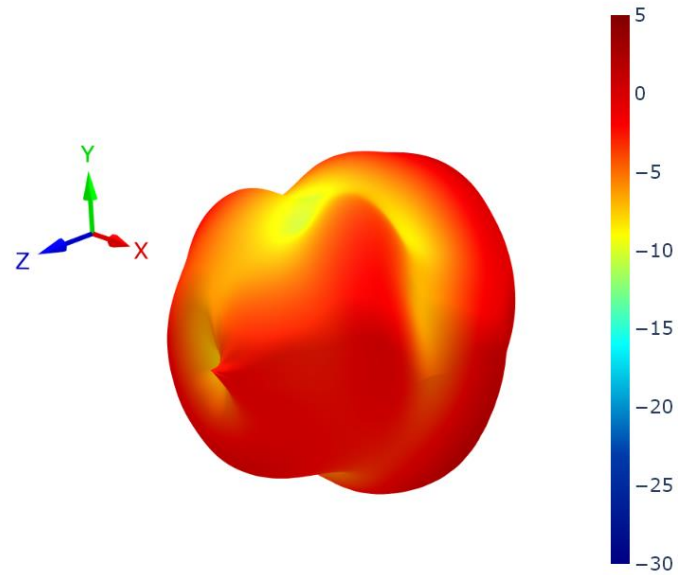

4.15 Bent on a 9x15cm Ground Plane Patterns at 1470 MHz

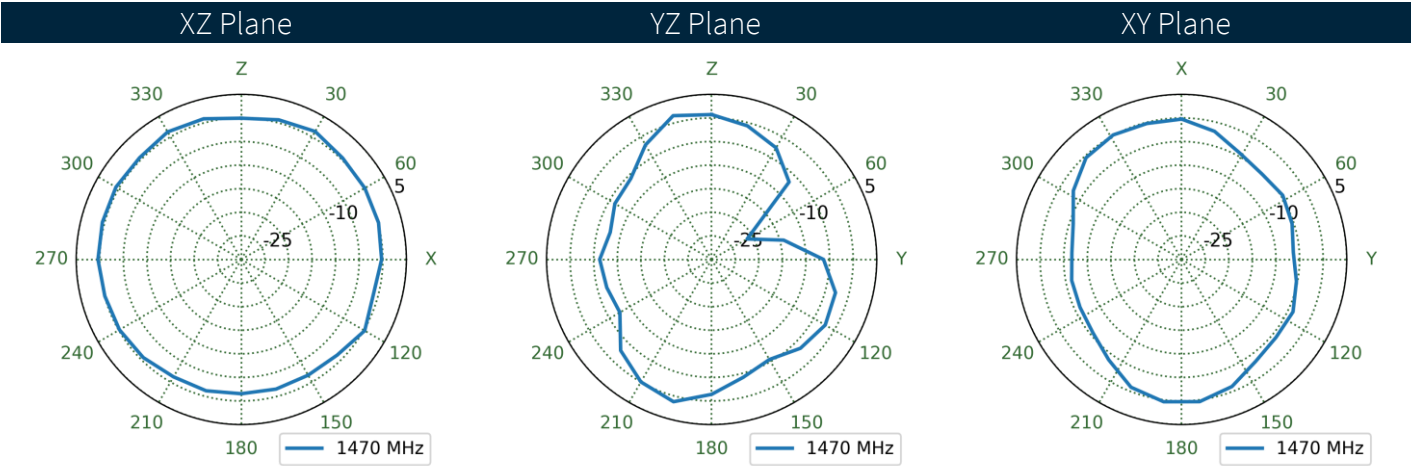
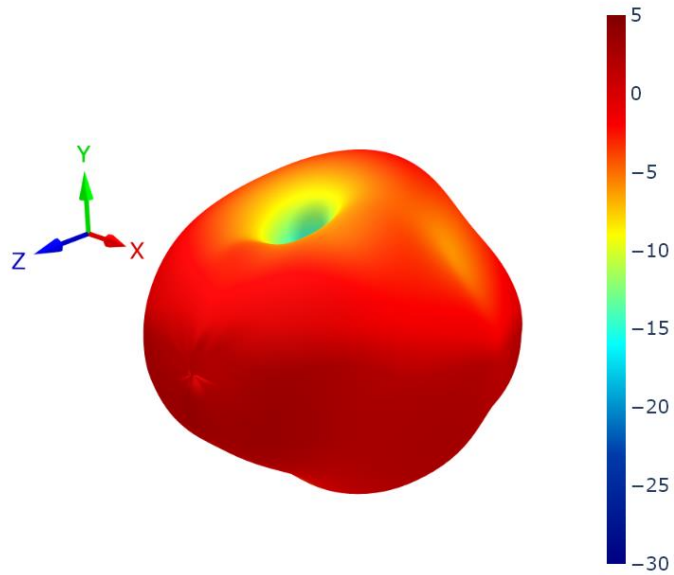

4.16 Straight in Free Space Patterns at 1470 MHz

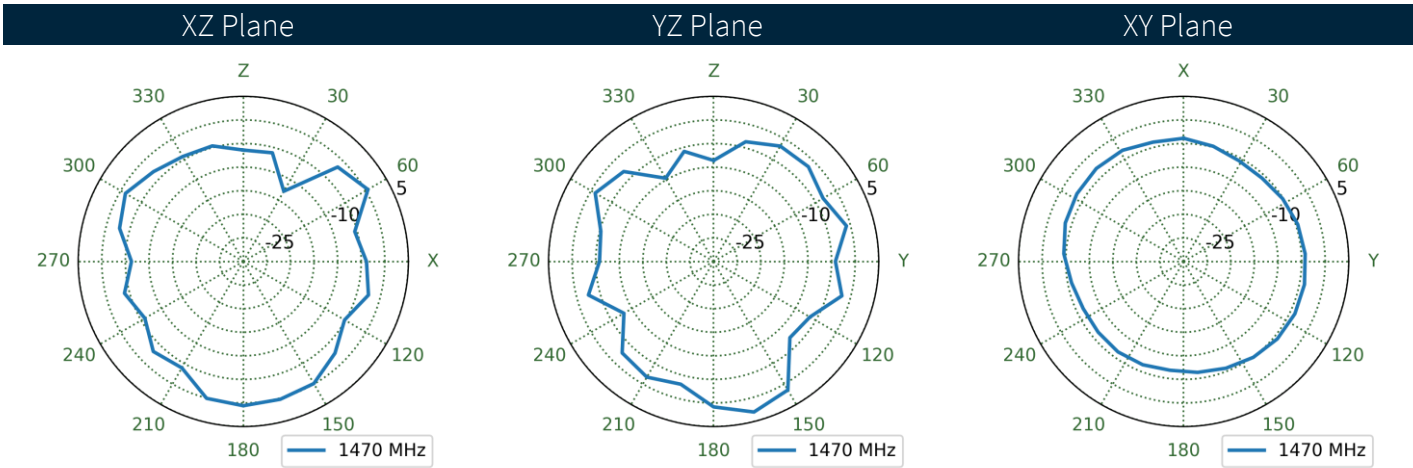
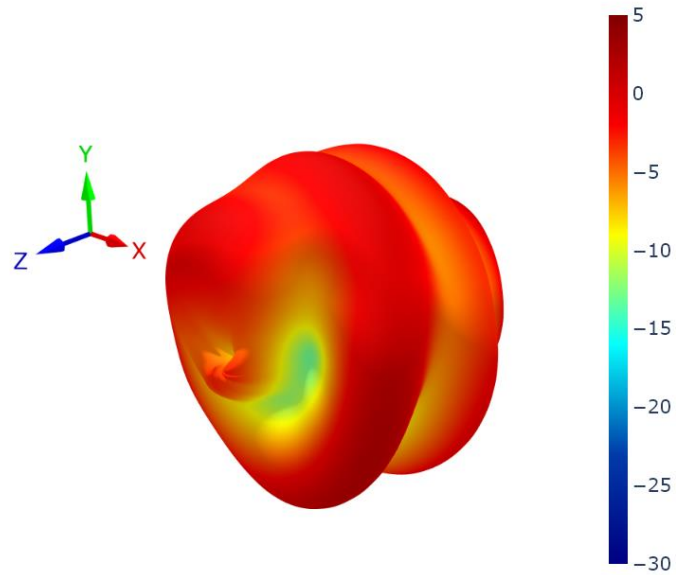

4.17 Straight on a 9x15cm Ground Plane Patterns at 1470 MHz

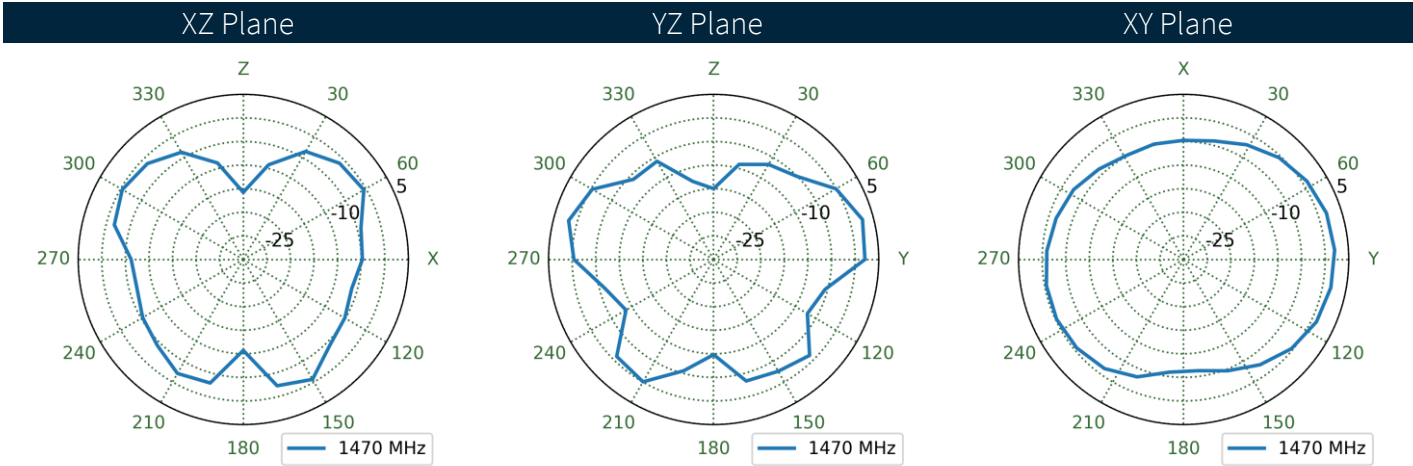
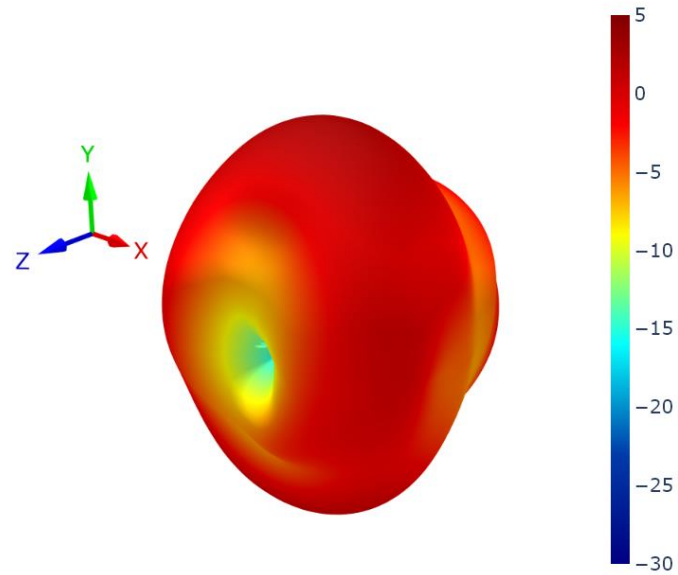

4.18 Bent in Free Space Patterns at 1575 MHz

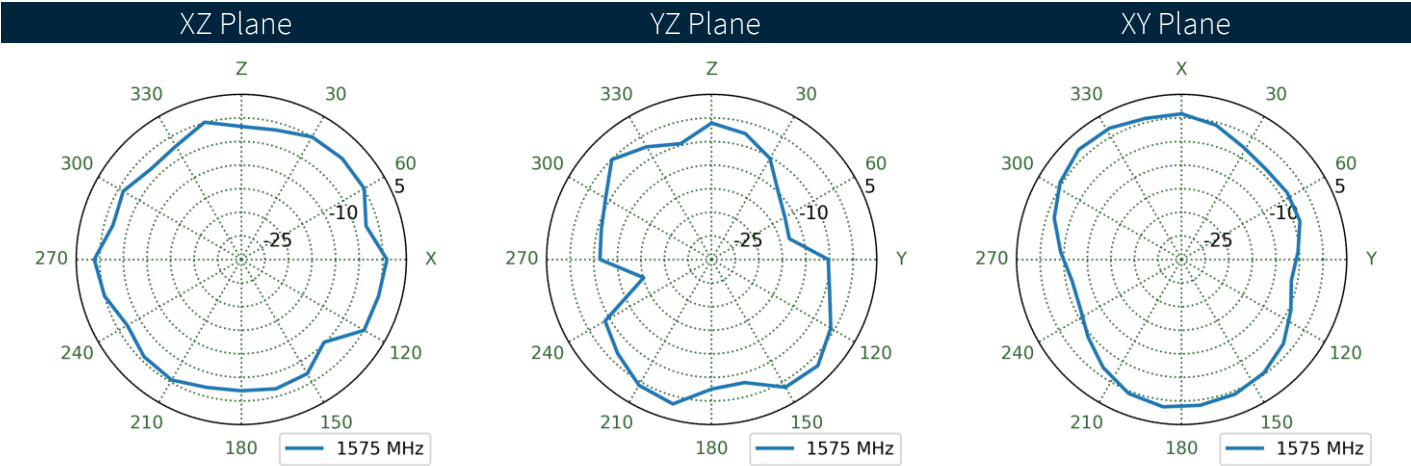
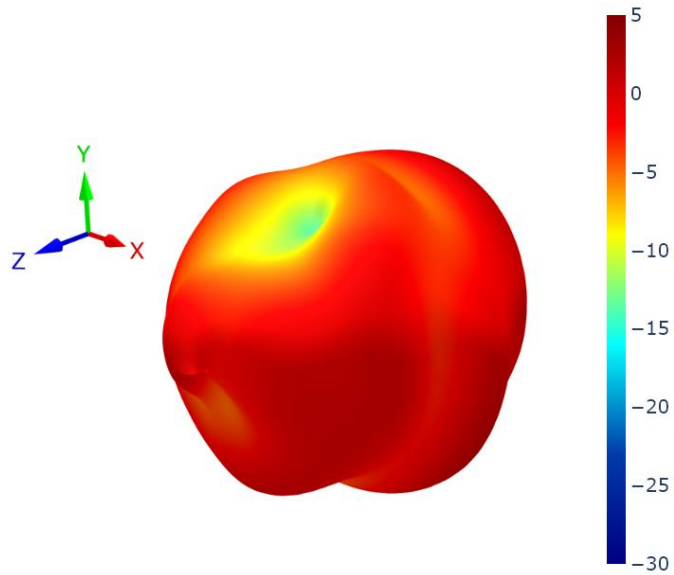

4.19 Bent on a 9x15cm Ground Plane Patterns at 1575 MHz

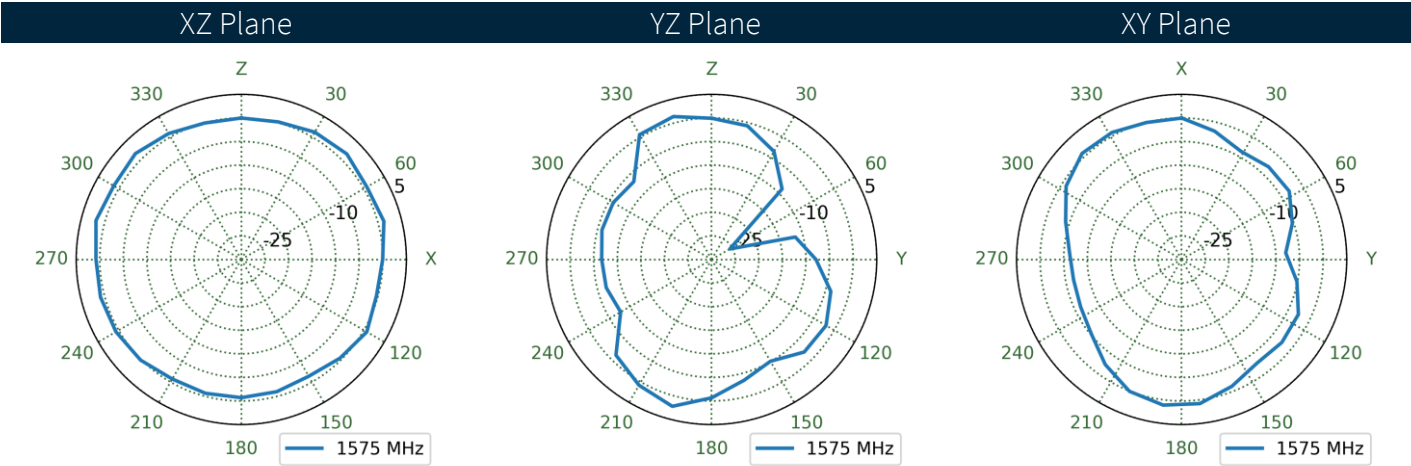
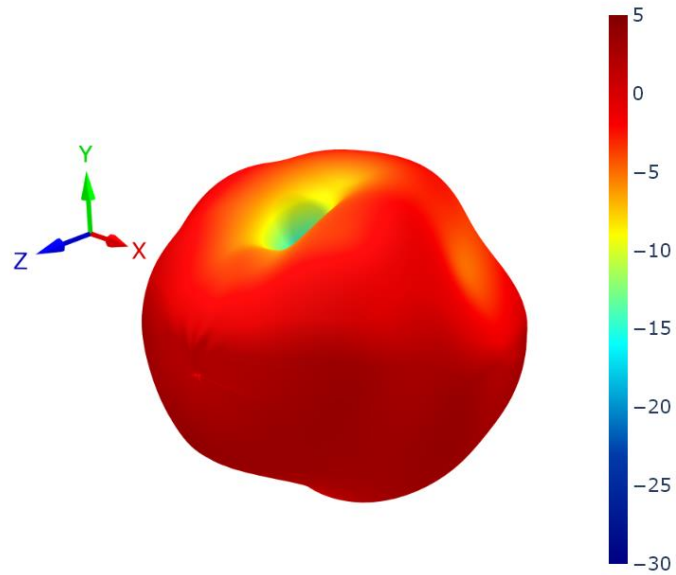

4.20 Straight in Free Space Patterns at 1575 MHz

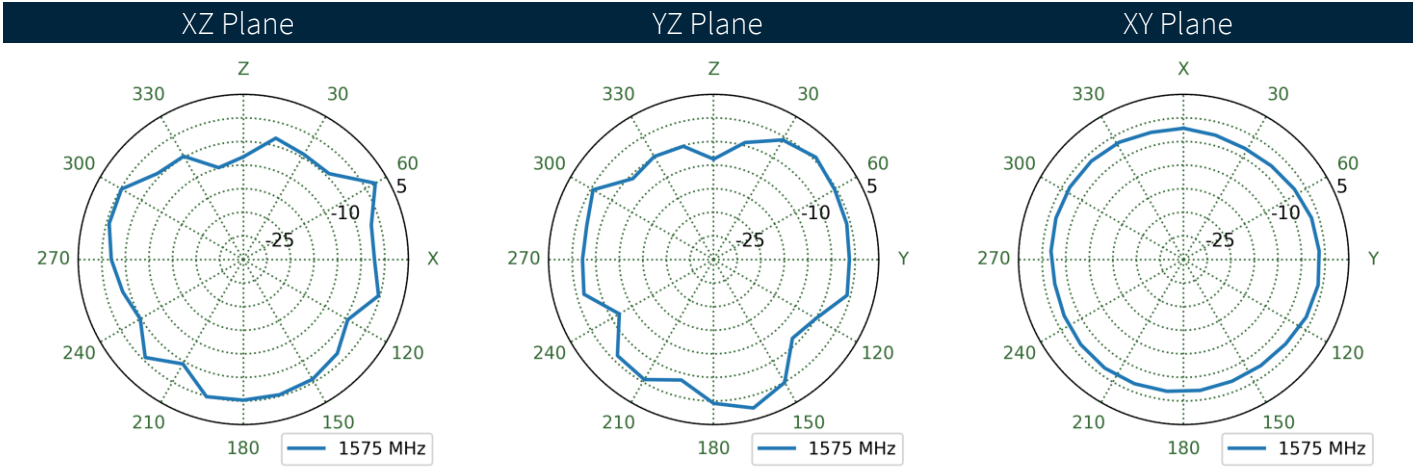
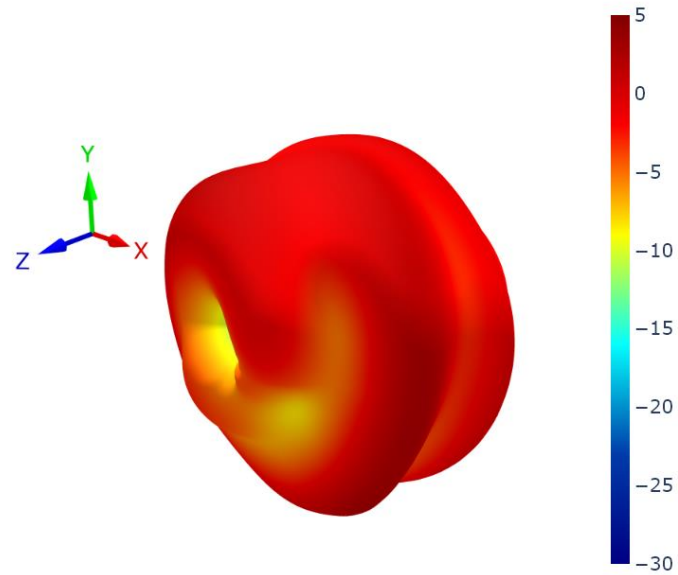

4.21 Straight on a 9x15cm Ground Plane Patterns at 1575 MHz

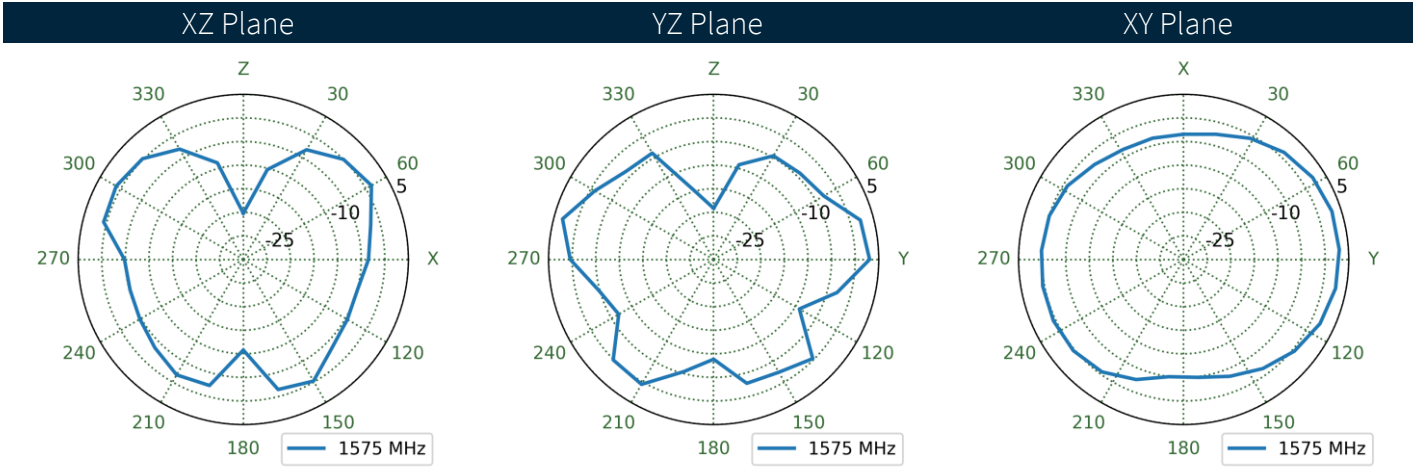
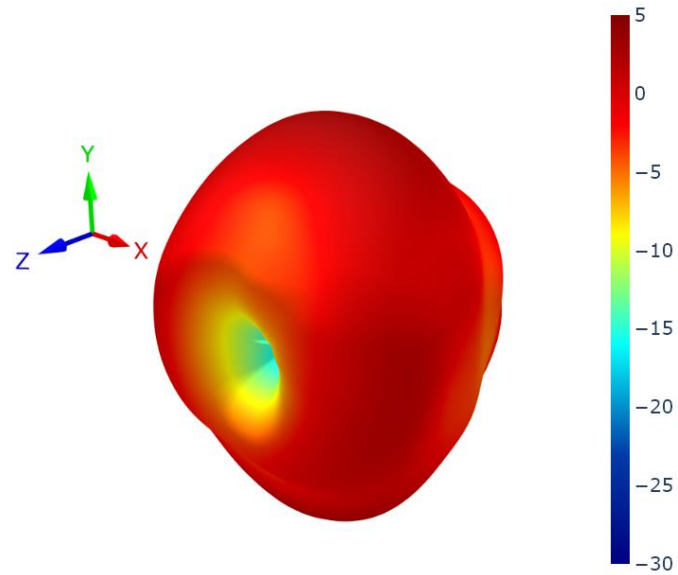

4.22 Bent in Free Space Patterns at 1805 MHz

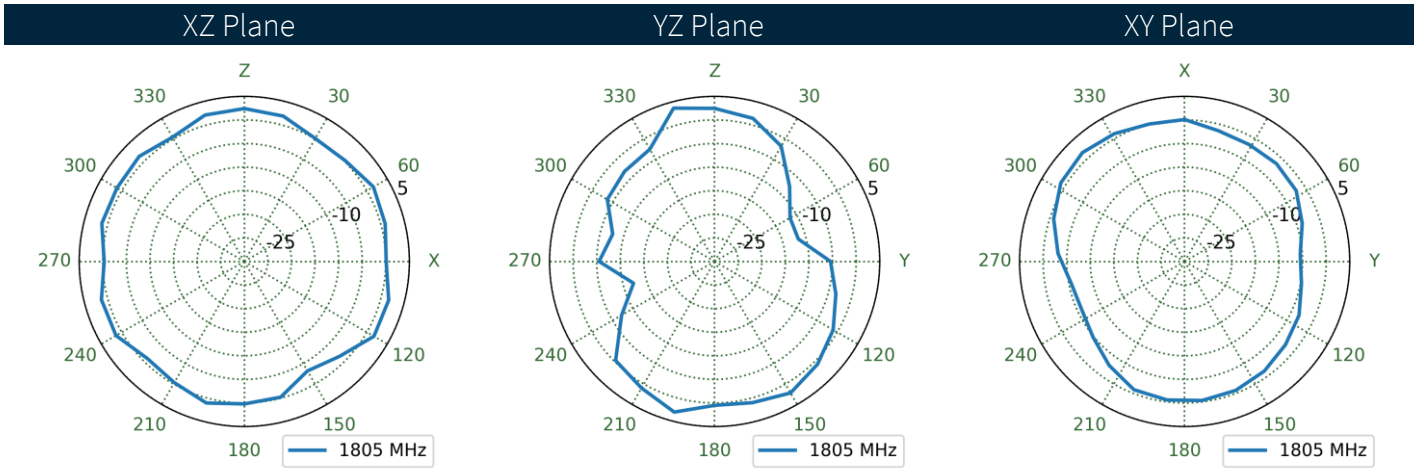
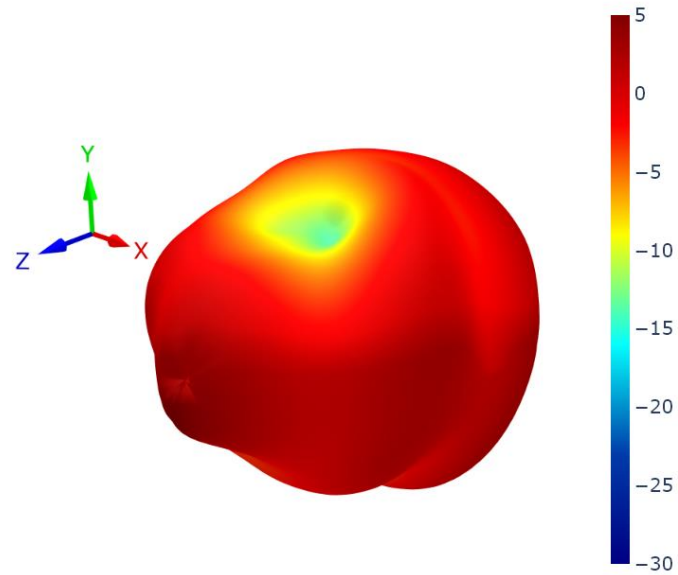

4.23 Bent on a 9x15cm Ground Plane Patterns at 1805 MHz

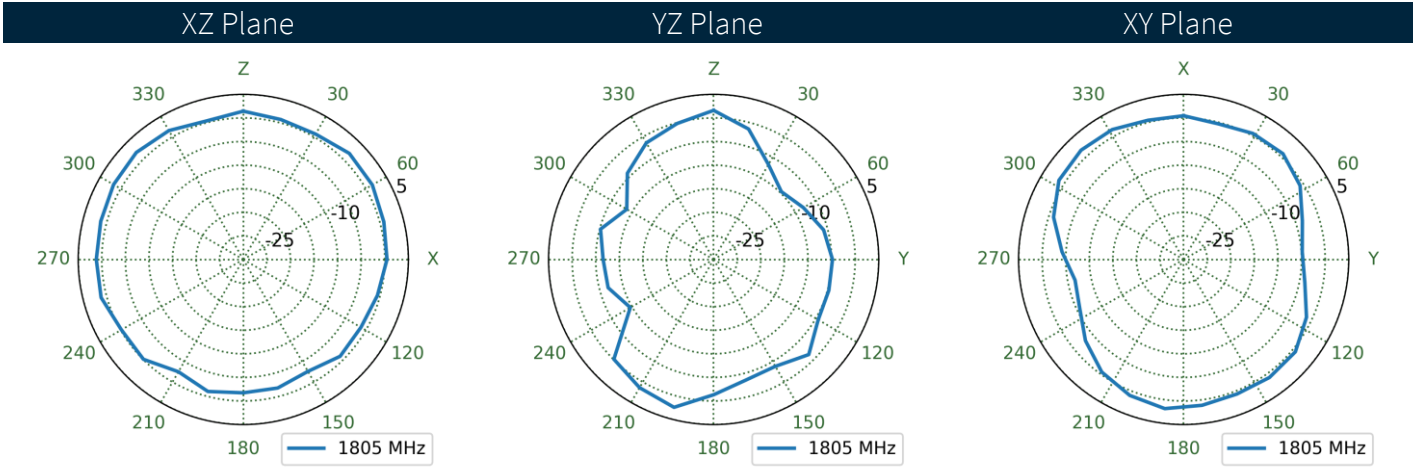
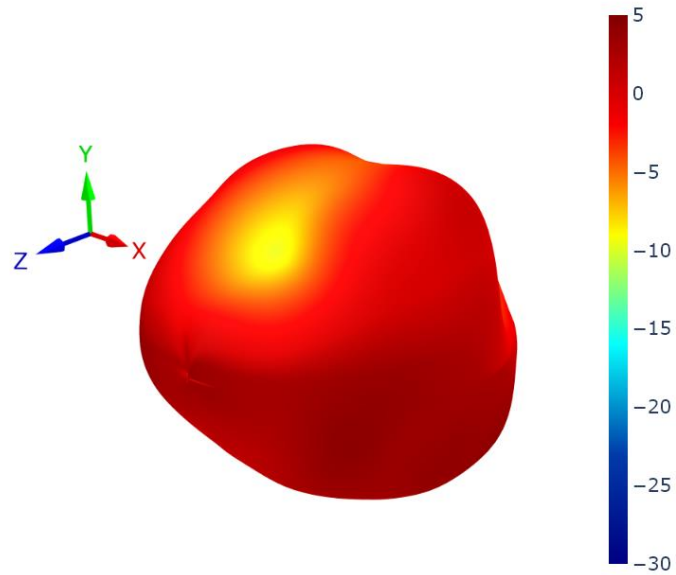

4.24 Straight in Free Space Patterns at 1805 MHz

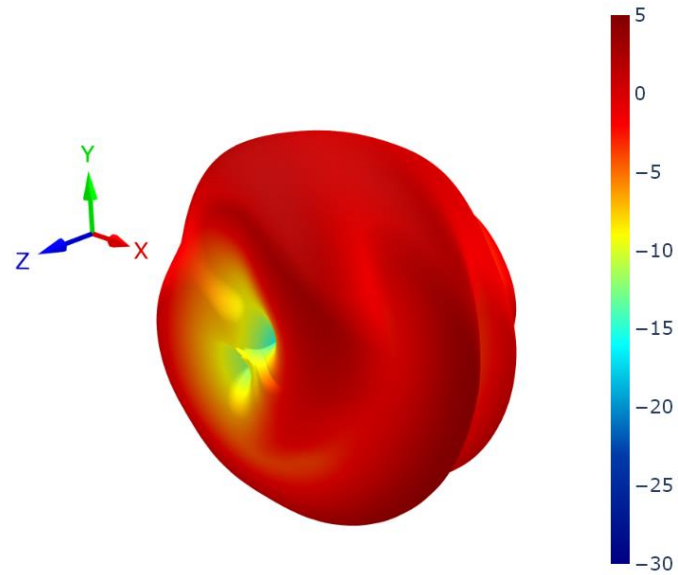

XZ Plane YZ Plane XY Plane

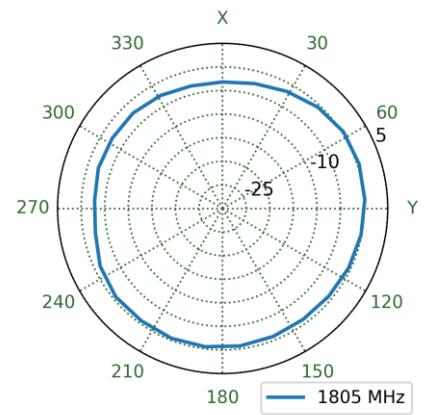
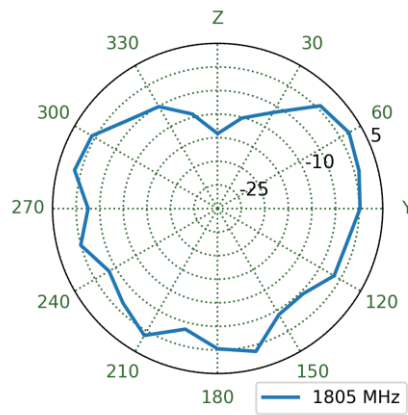
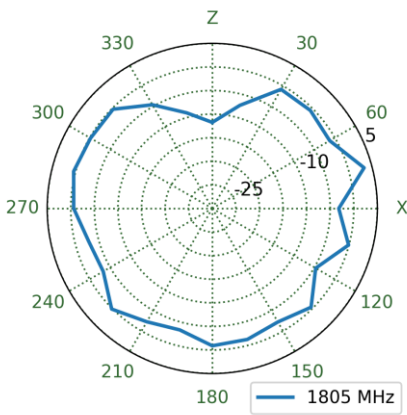

4.25 Straight on a 9x15cm Ground Plane Patterns at 1805 MHz

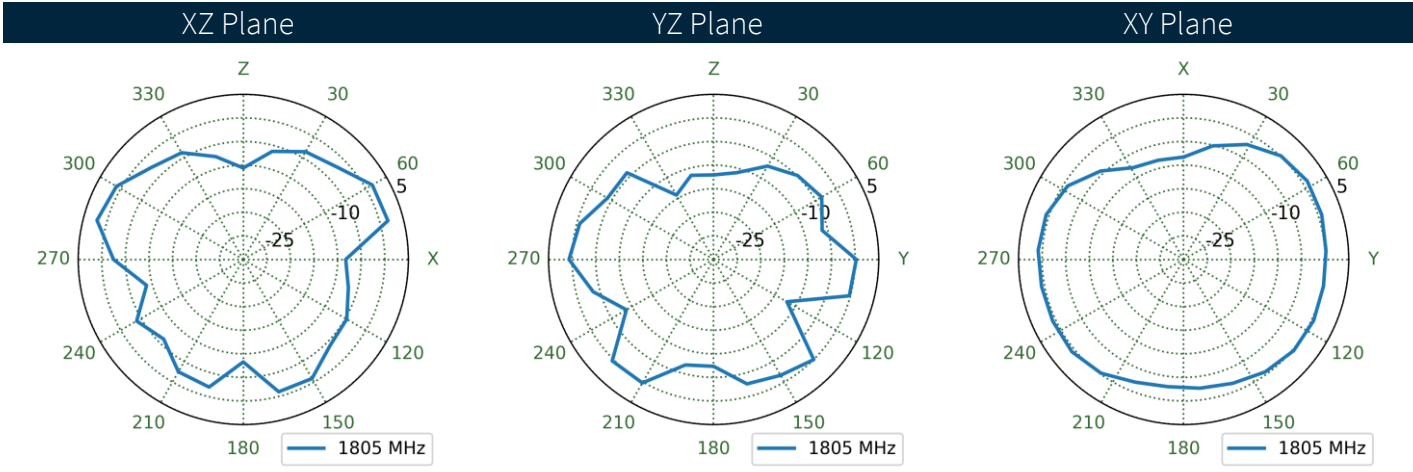
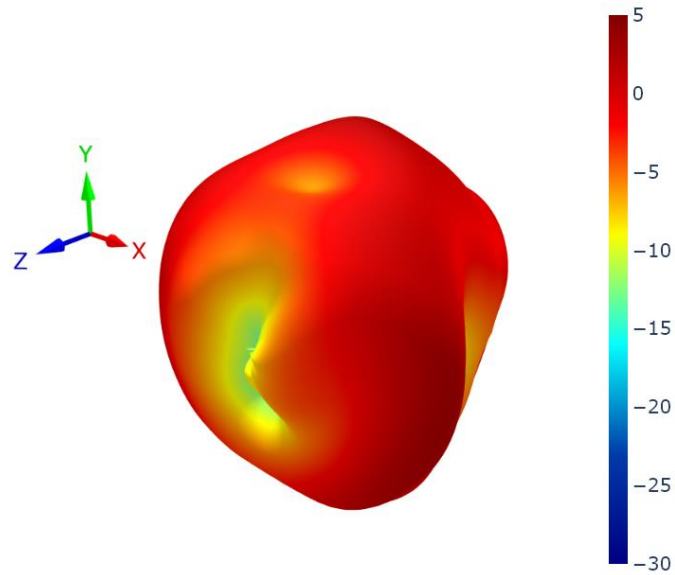

4.26 Bent in Free Space Patterns at 1920 MHz

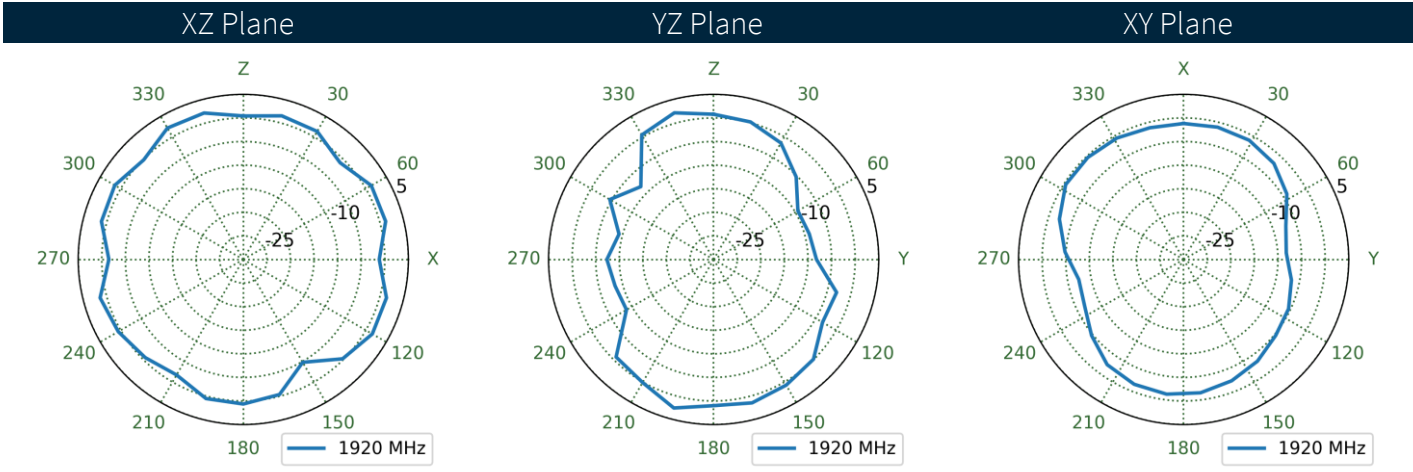
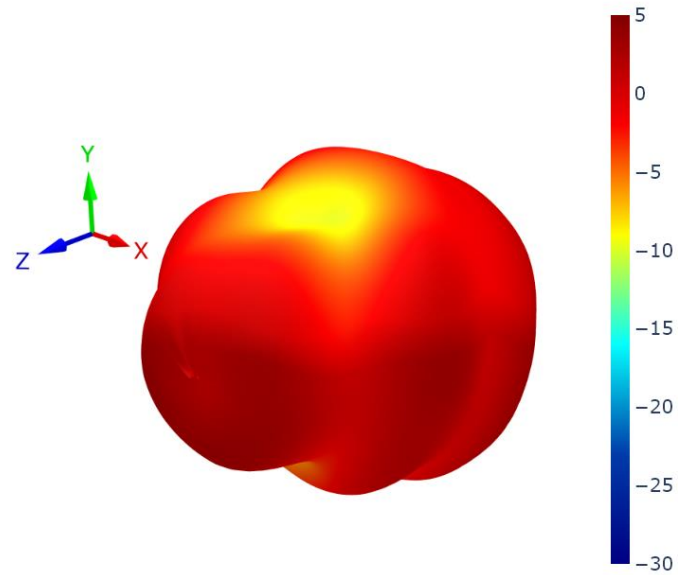

4.27 Bent on a 9x15cm Ground Plane Patterns at 1920 MHz

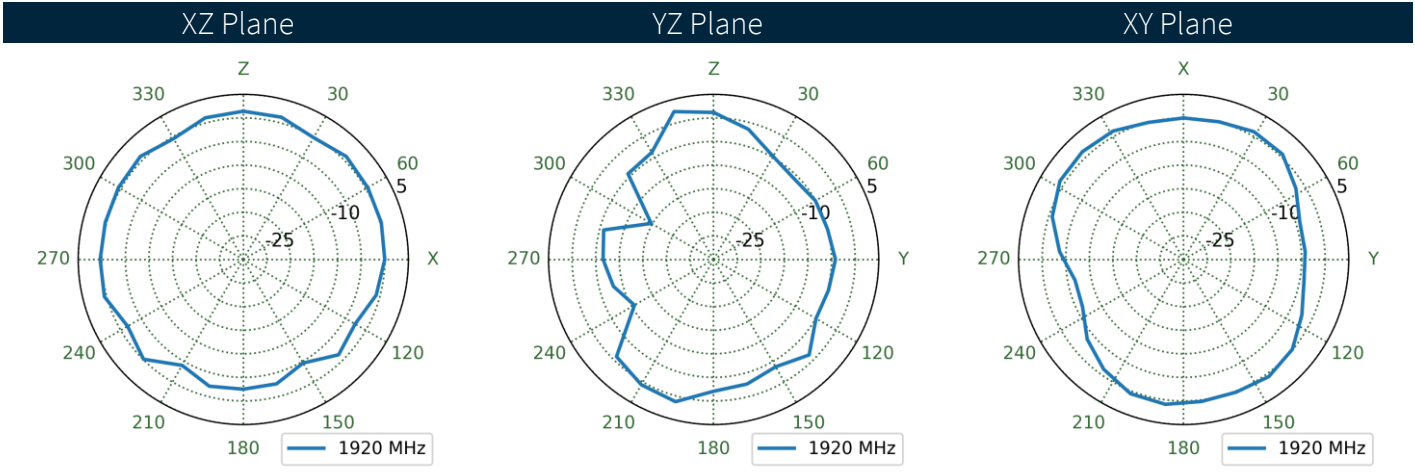
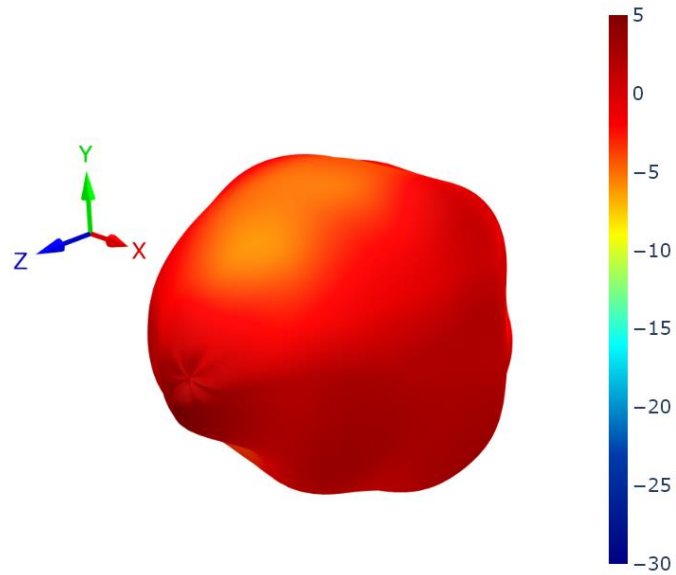

4.28 Straight in Free Space Patterns at 1920 MHz

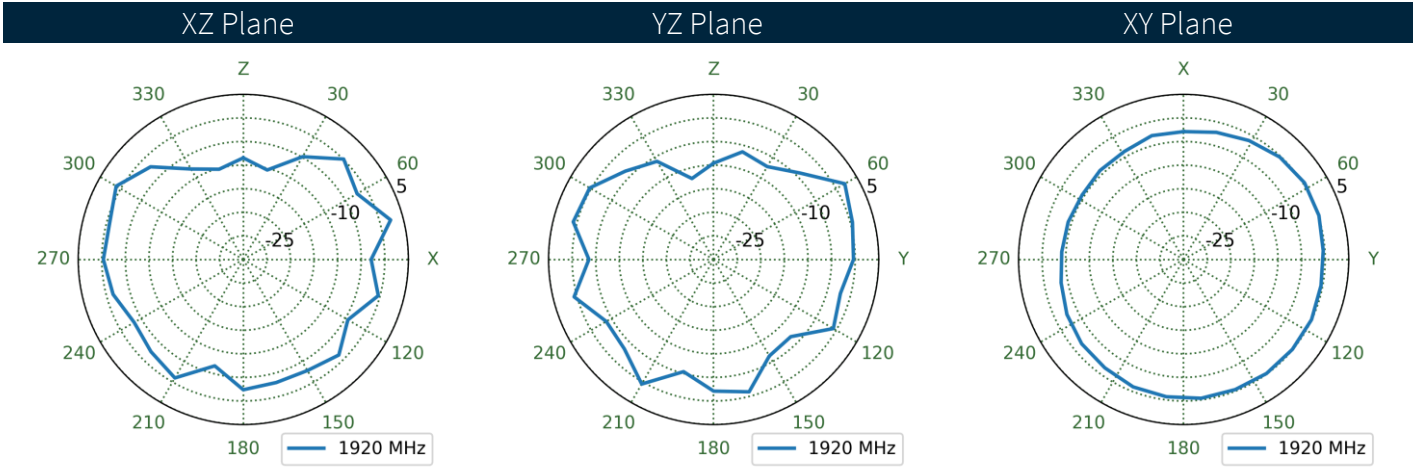
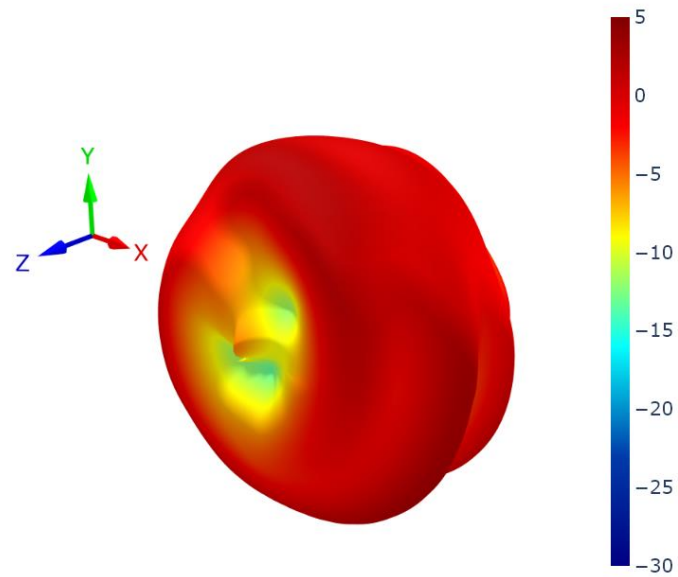

4.29 Straight on a 9x15cm Ground Plane Patterns at 1920 MHz

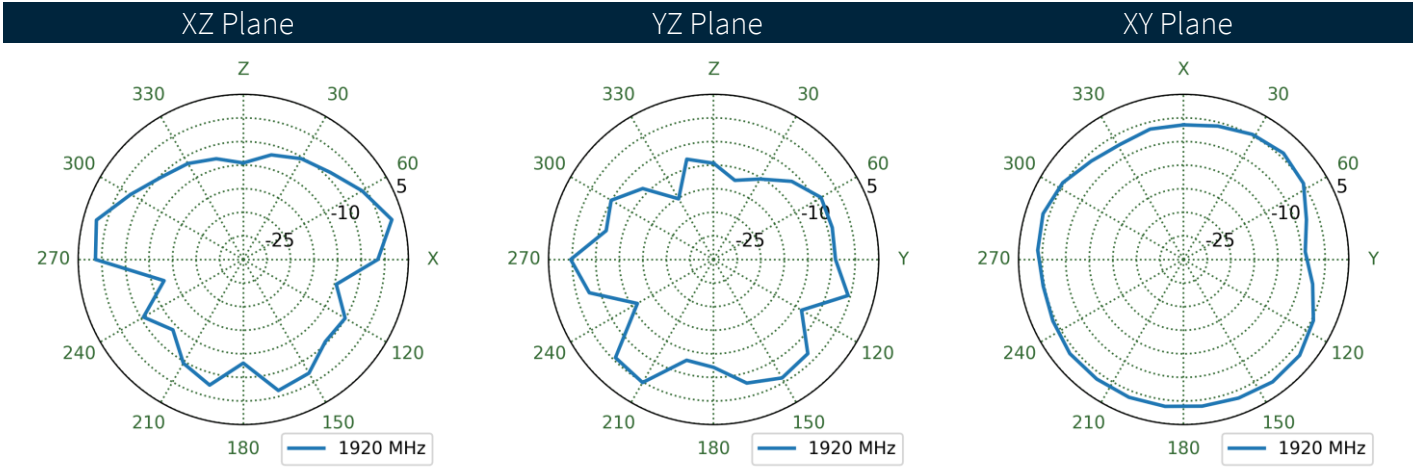
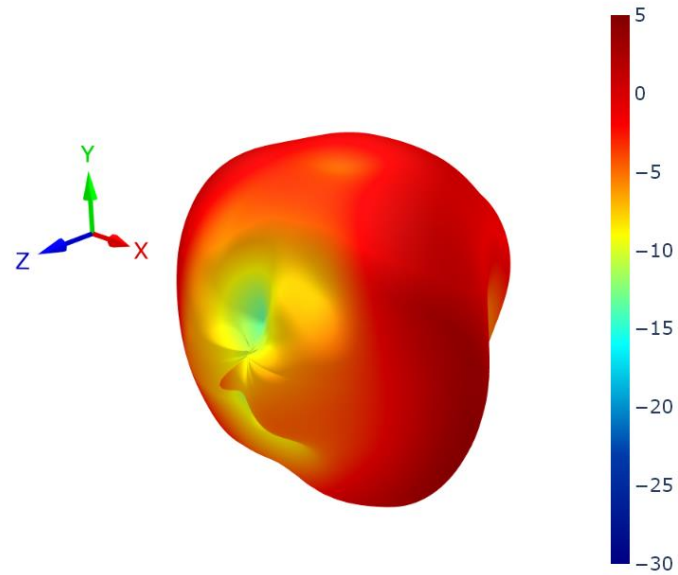

4.30 Bent in Free Space Patterns at 1990 MHz

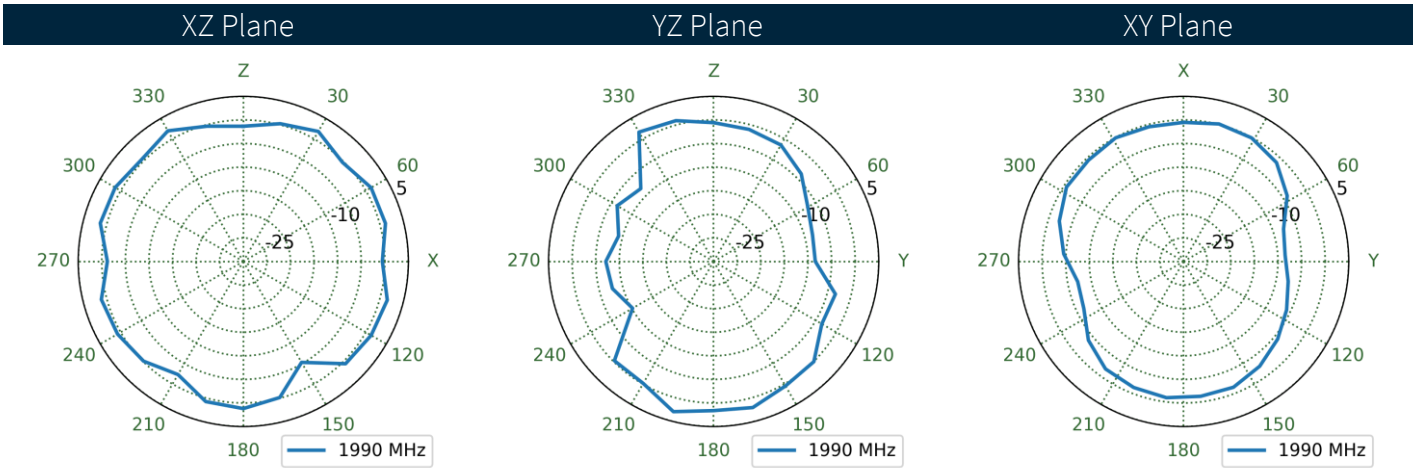
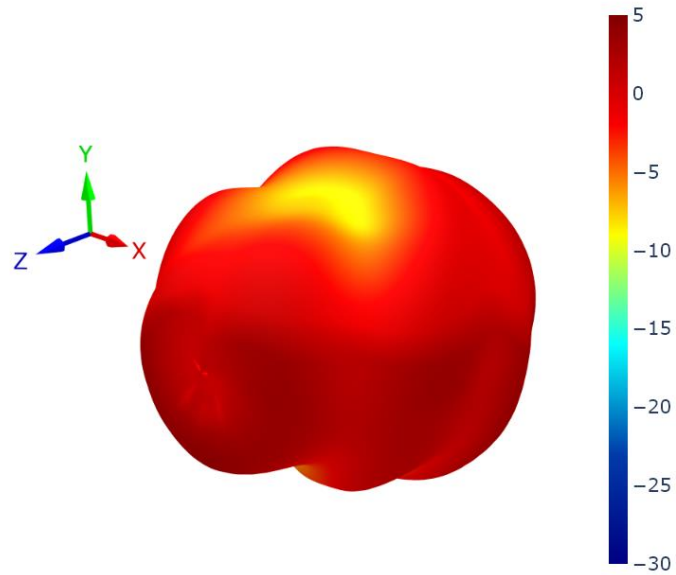

4.31 Bent on a 9x15cm Ground Plane Patterns at 1990 MHz

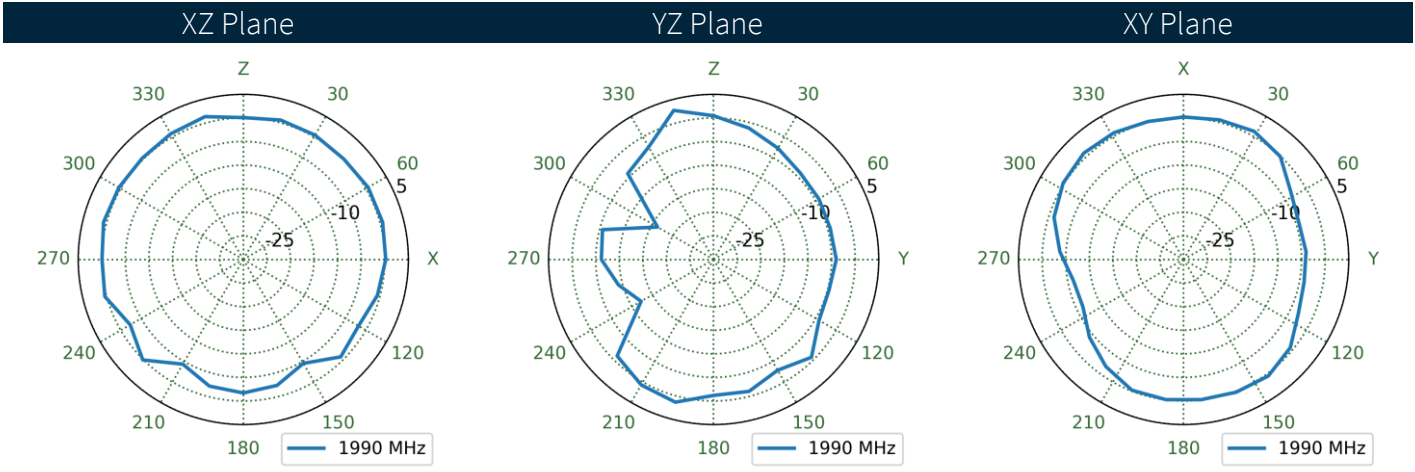
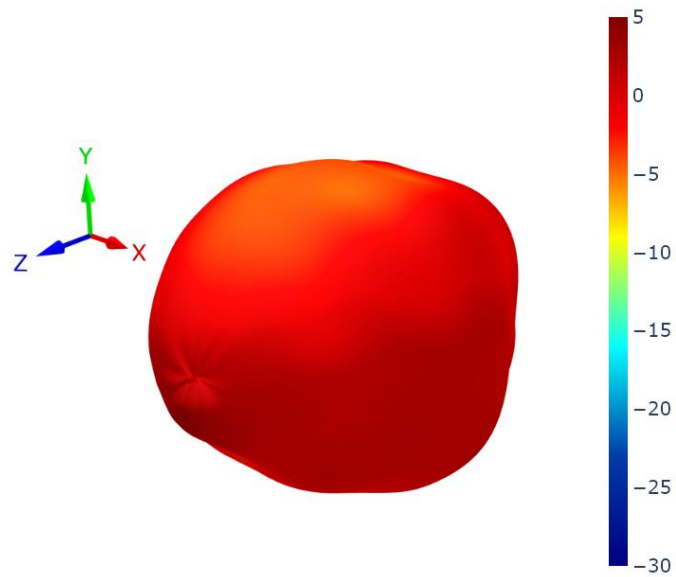

4.32 Straight in Free Space Patterns at 1990 MHz

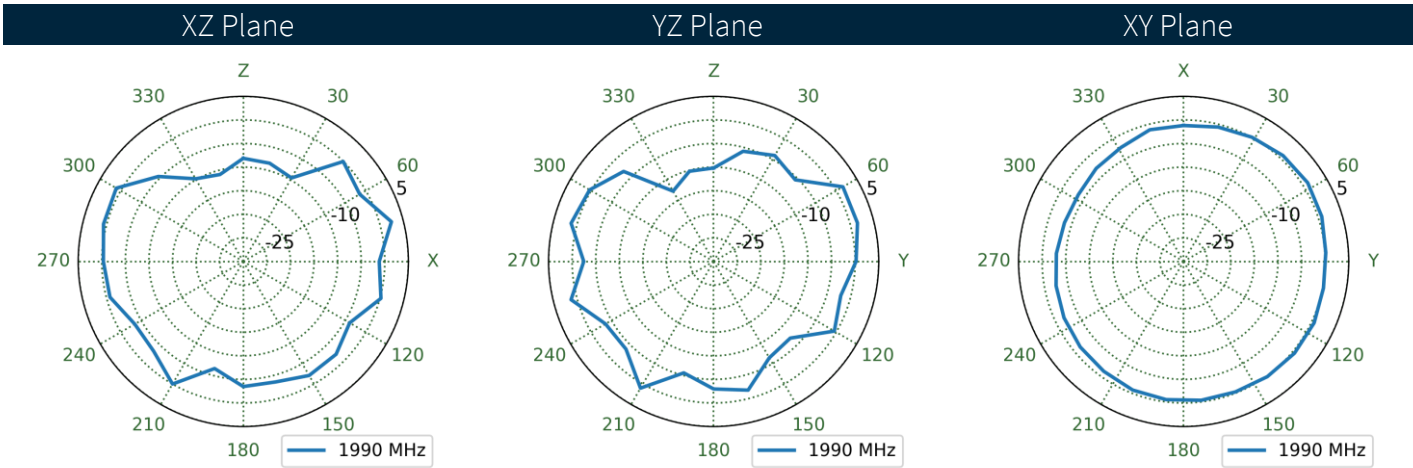
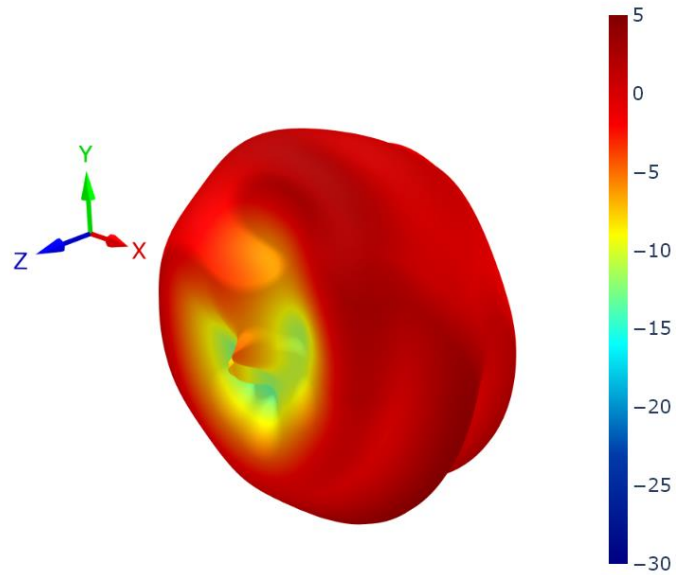

4.33 Straight on a 9x15cm Ground Plane Patterns at 1990 MHz

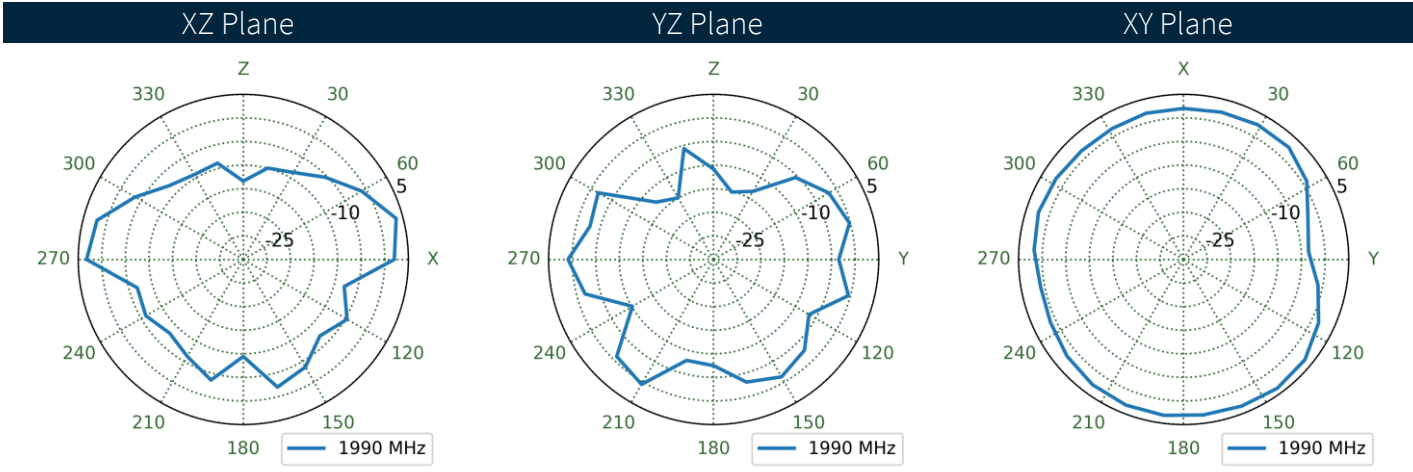
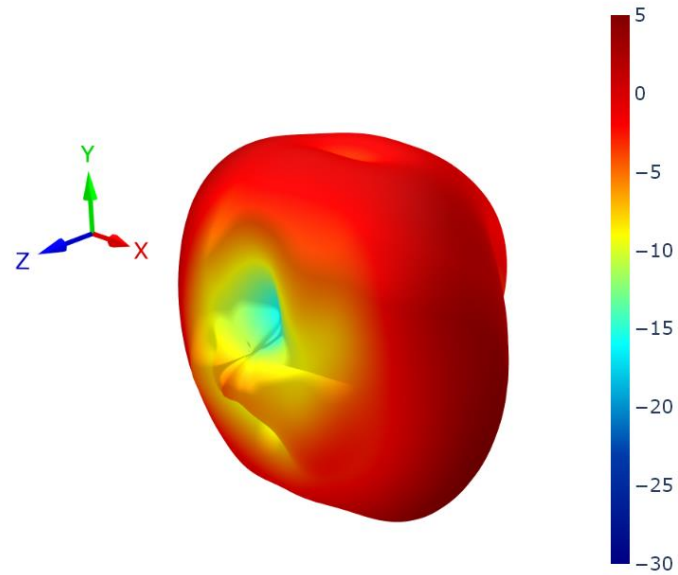

4.34 Bent in Free Space Patterns at 2595 MHz

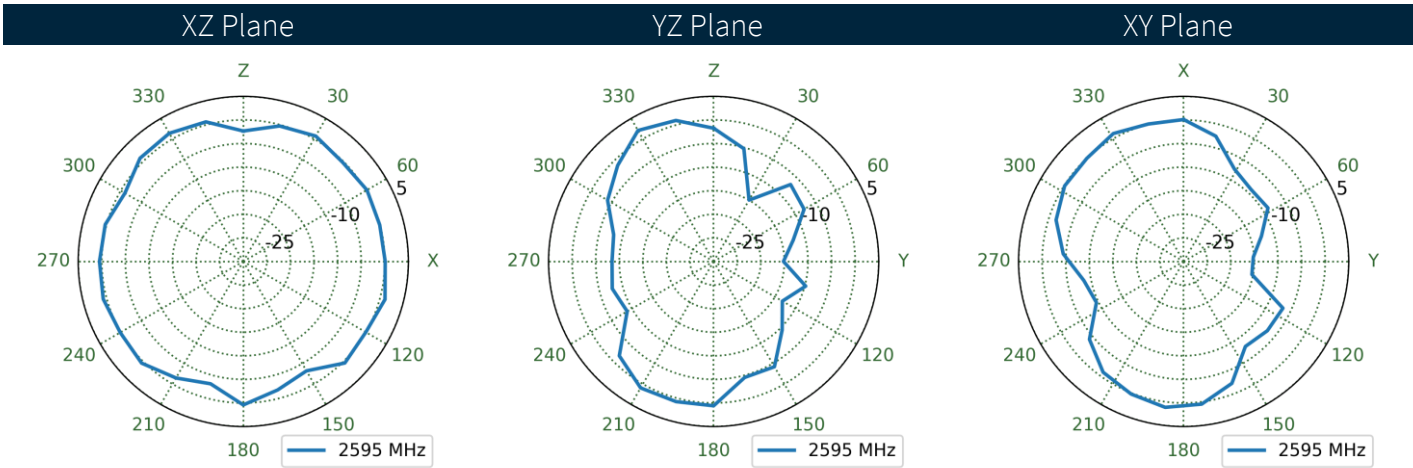
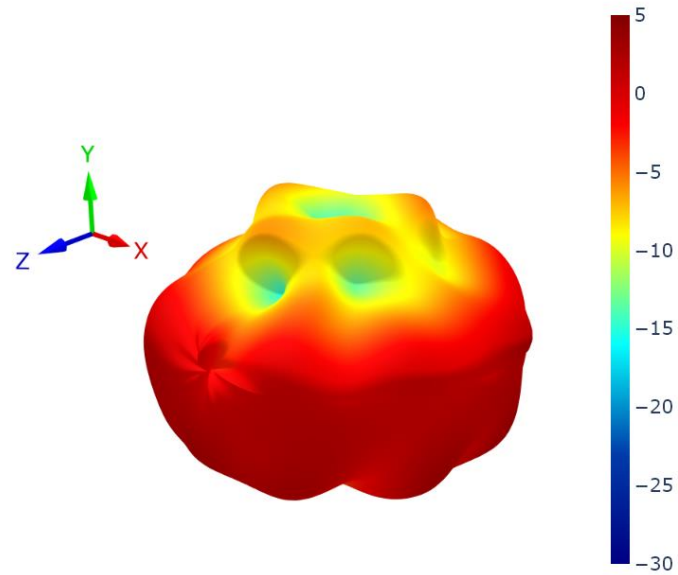

4.35 Bent on a 9x15cm Ground Plane Patterns at 2595 MHz

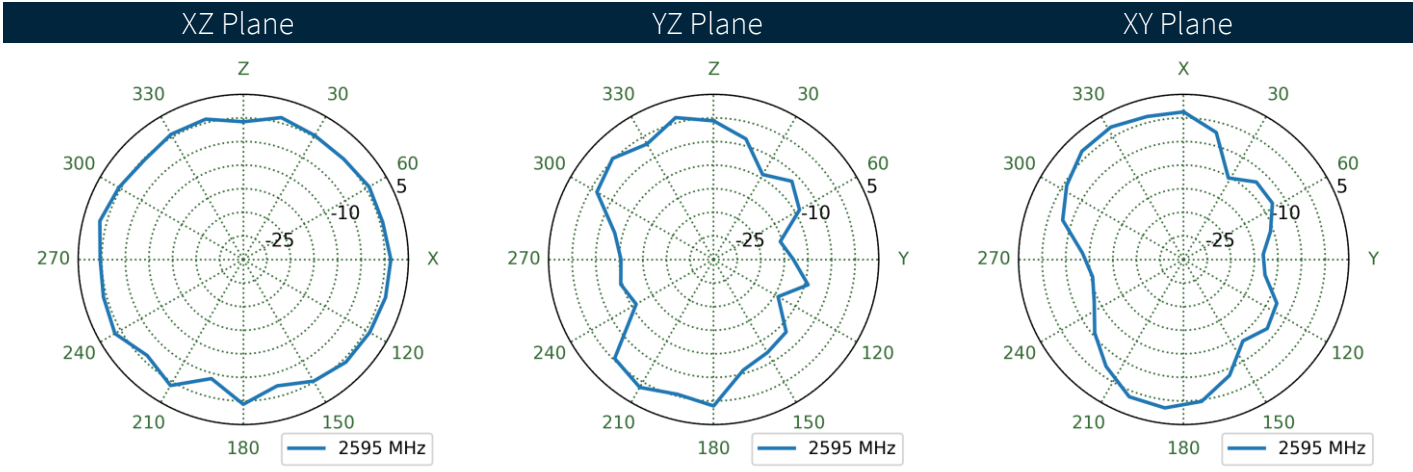
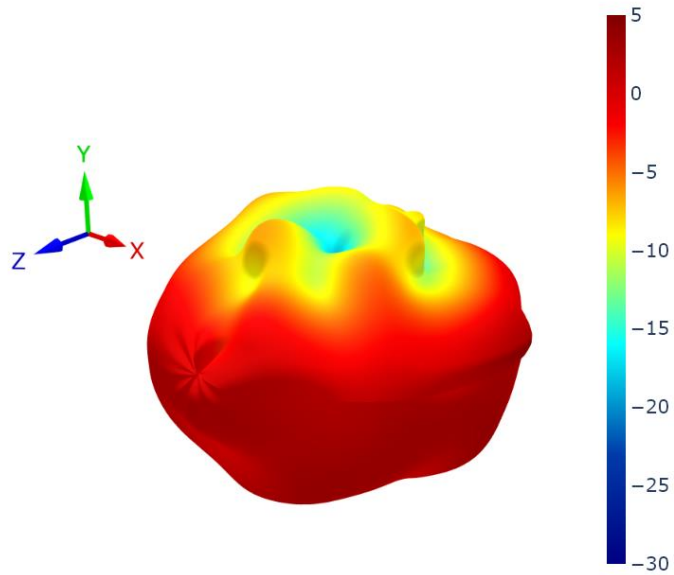

4.36 Straight in Free Space Patterns at 2595 MHz

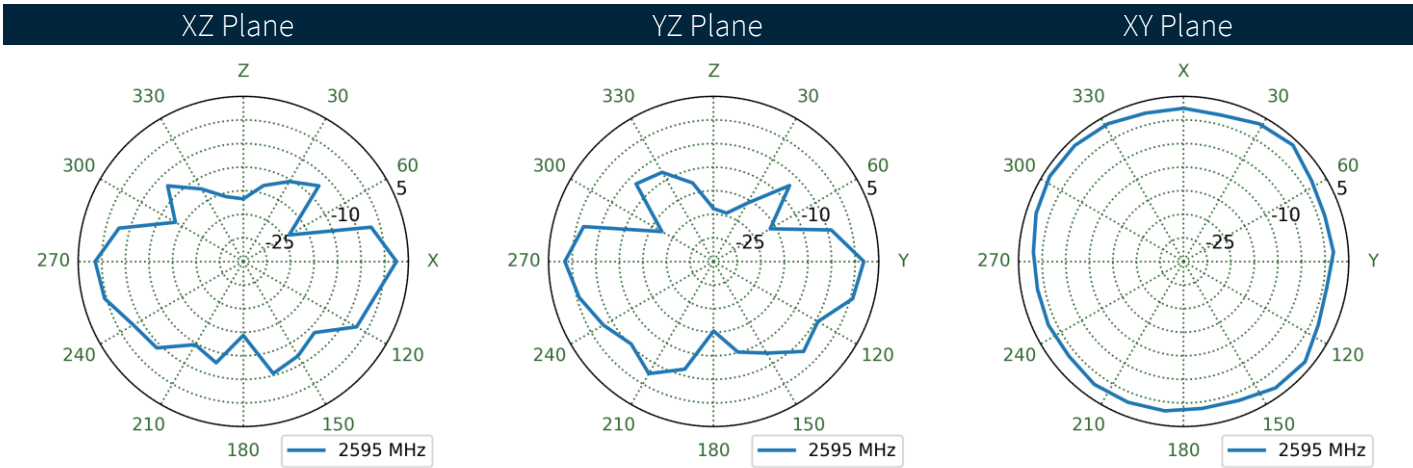
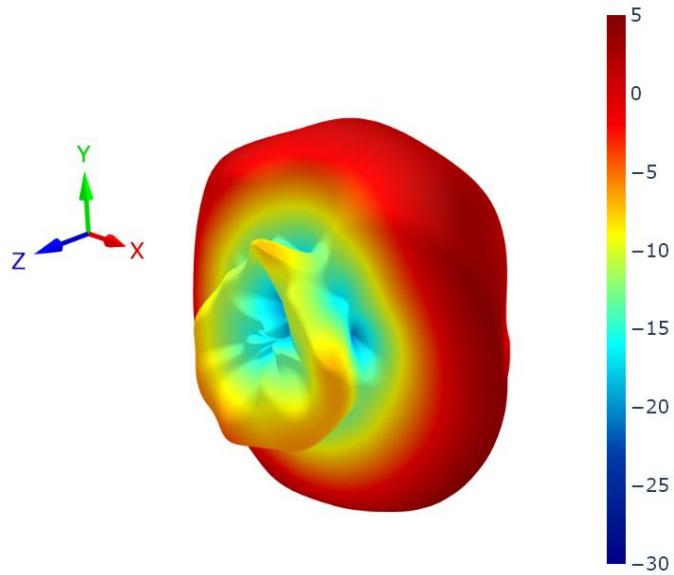

4.37 Straight on a 9x15cm Ground Plane Patterns at 2595 MHz

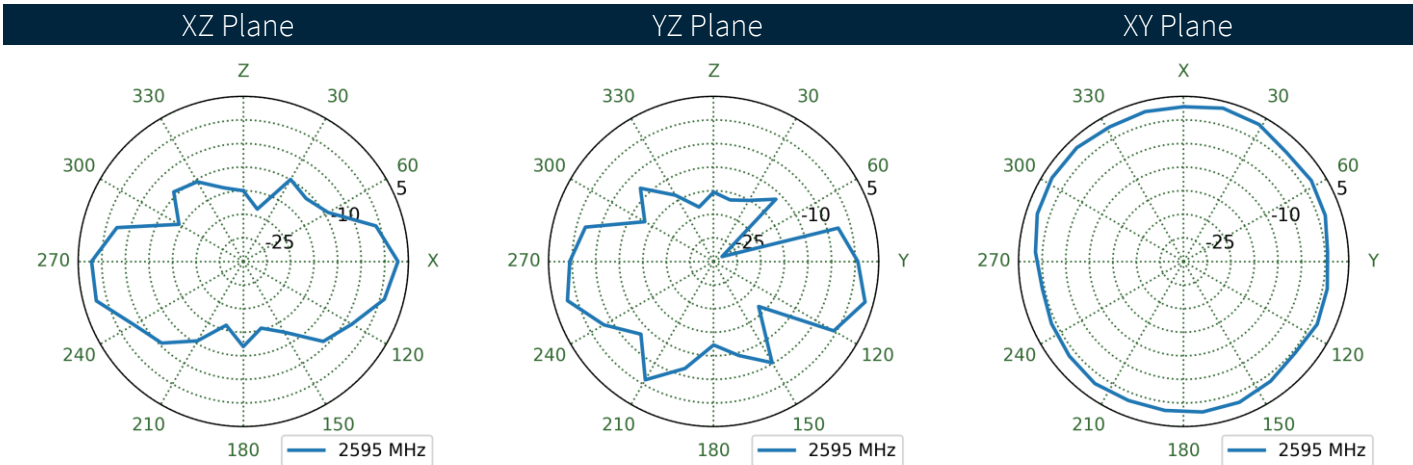
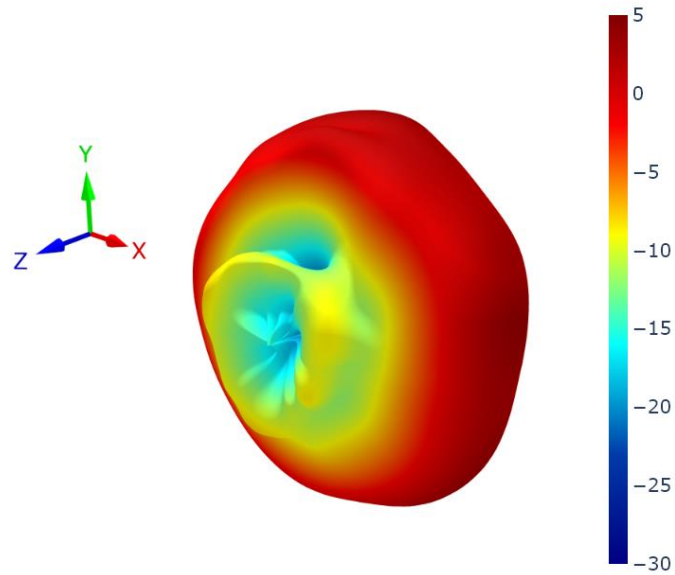

4.38 Bent in Free Space Patterns at 3550 MHz

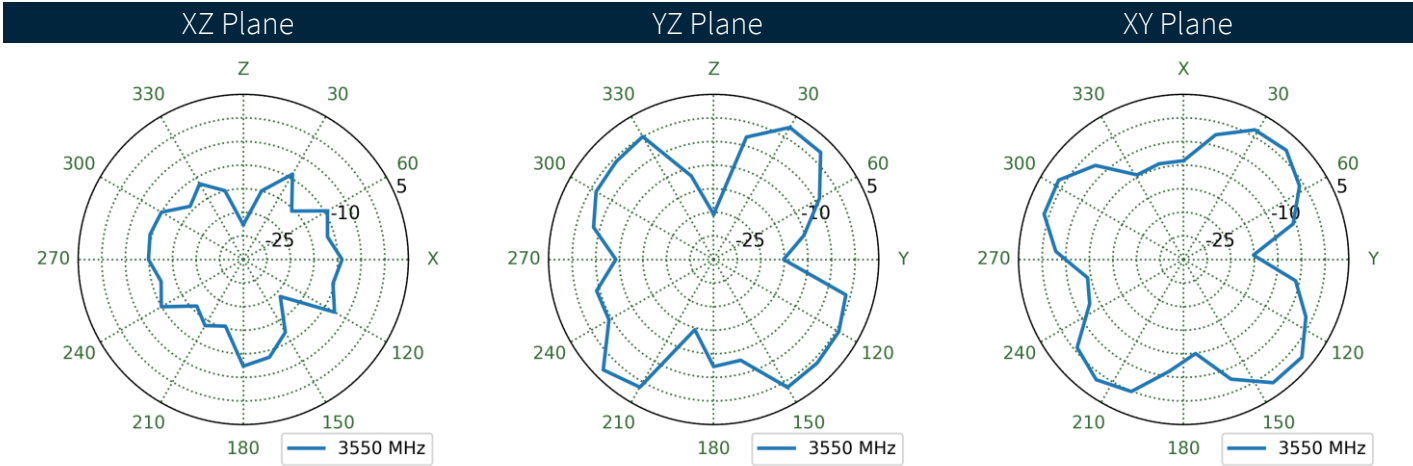
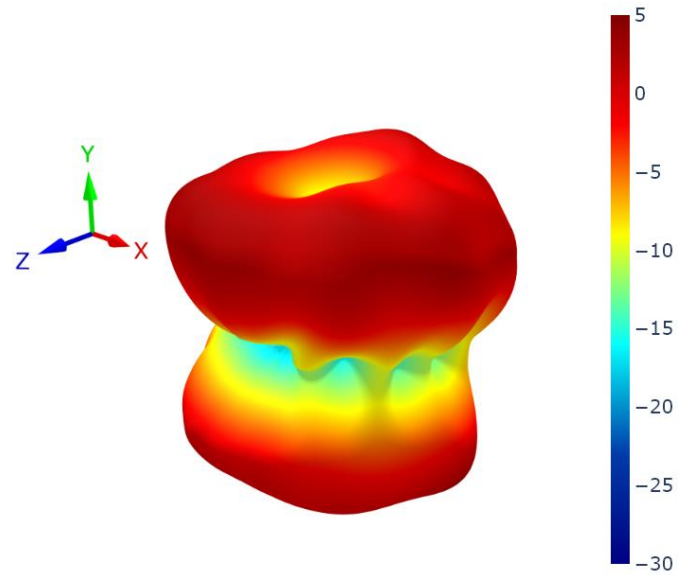

4.39 Bent on a 9x15cm Ground Plane Patterns at 3550 MHz

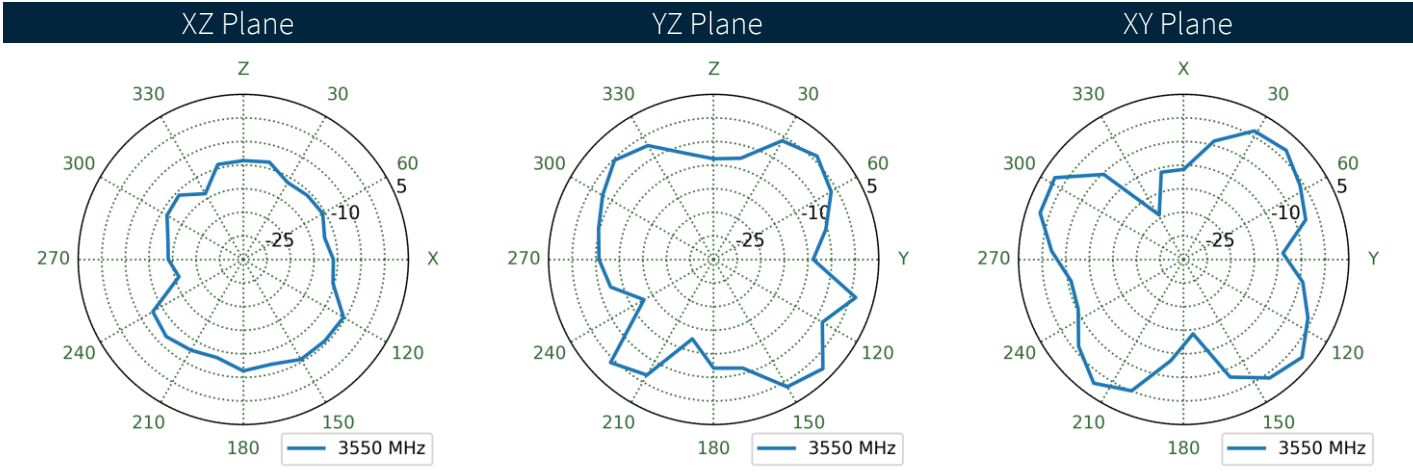
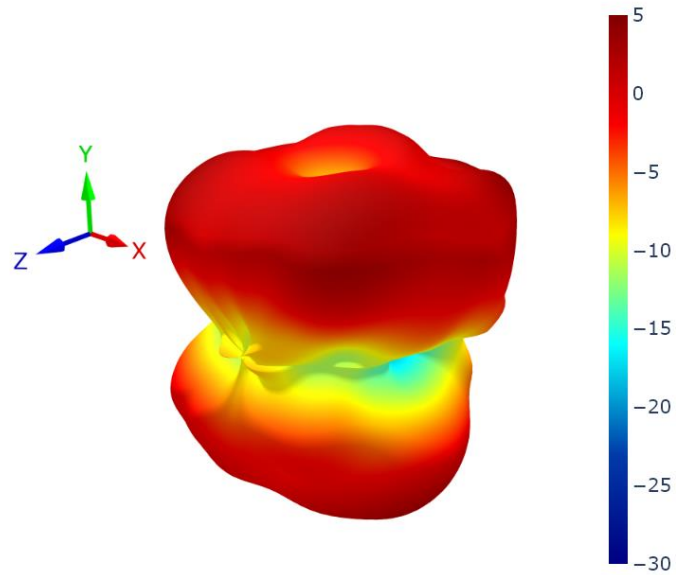

4.40 Straight in Free Space Patterns at 3550 MHz

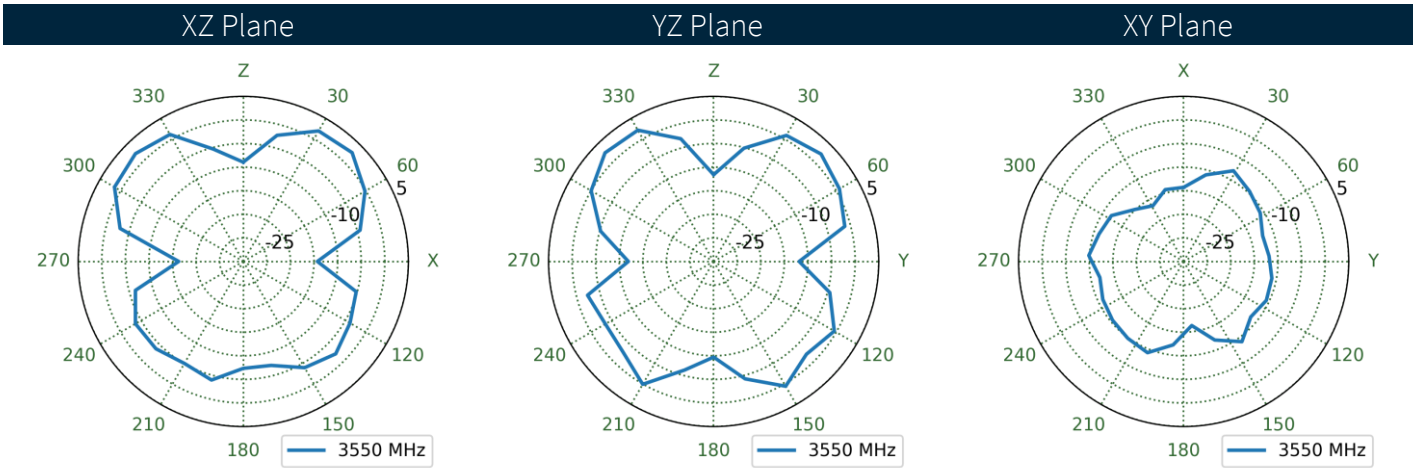
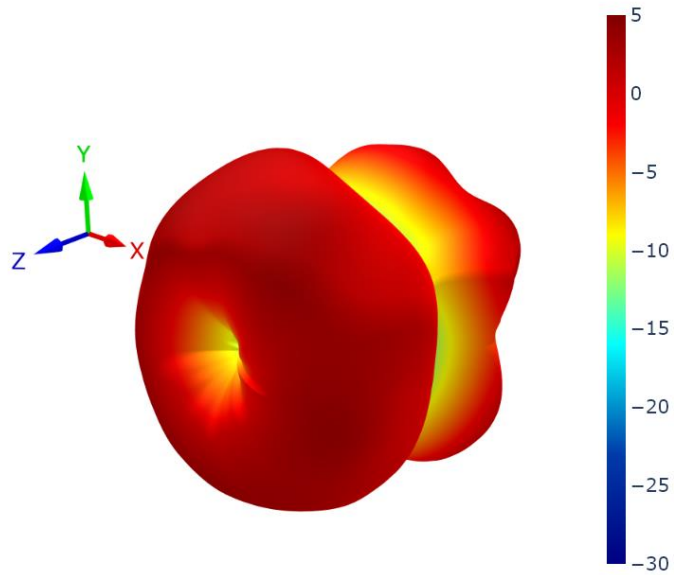

4.41 Straight on a 9x15cm Ground Plane Patterns at 3550 MHz

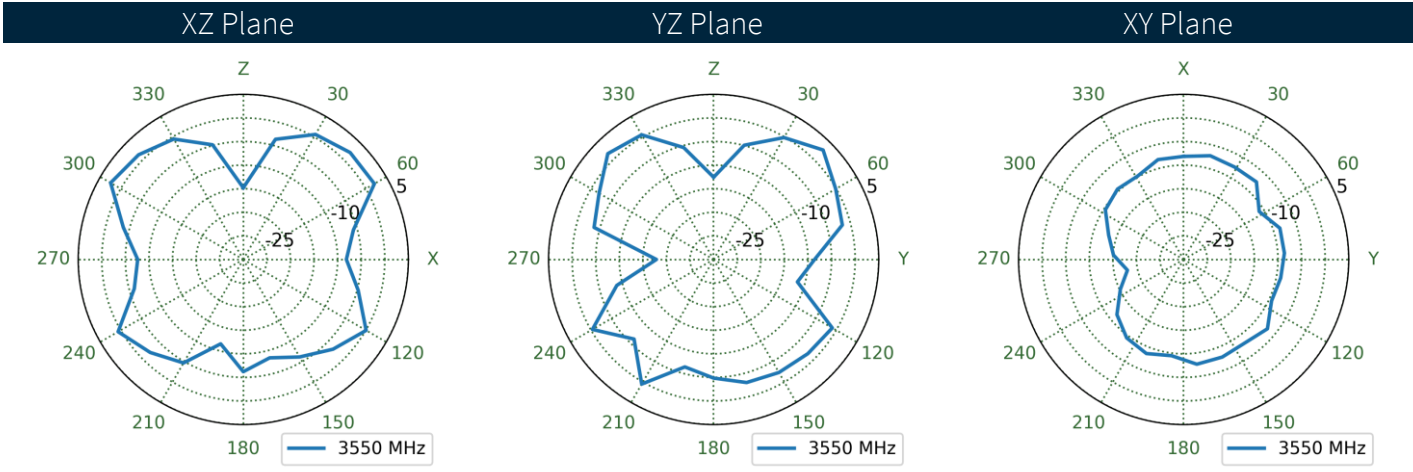
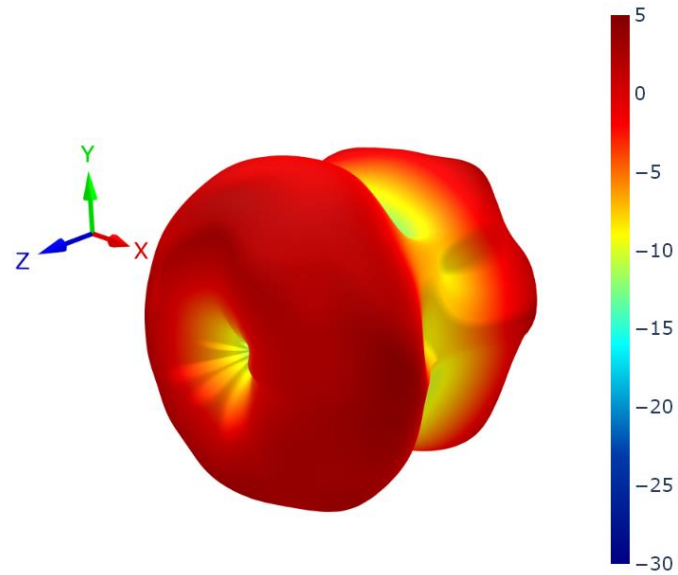

4.42 Bent in Free Space Patterns at 5530 MHz

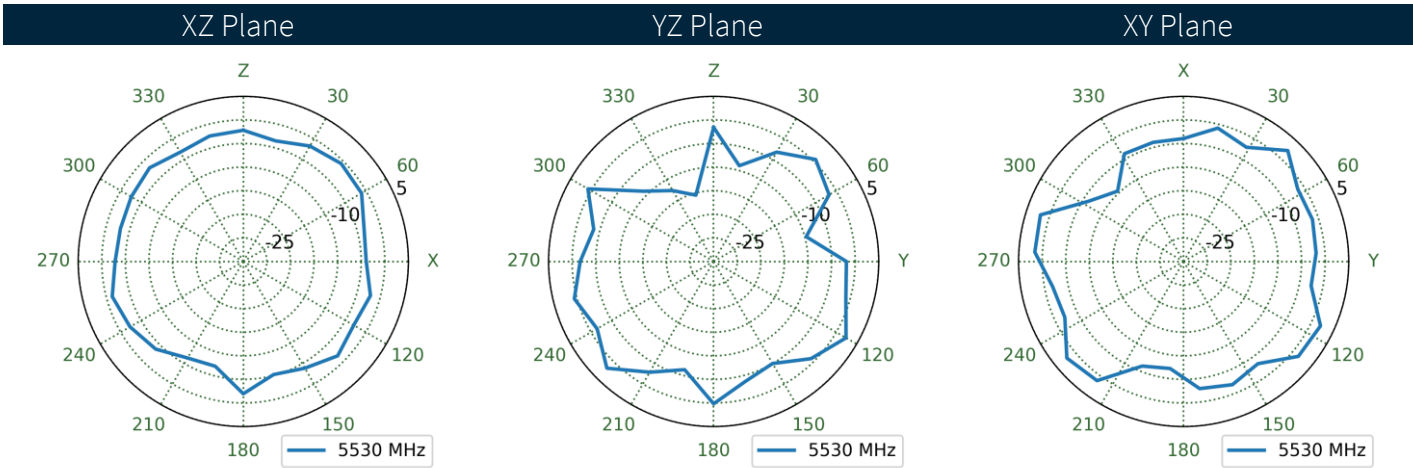
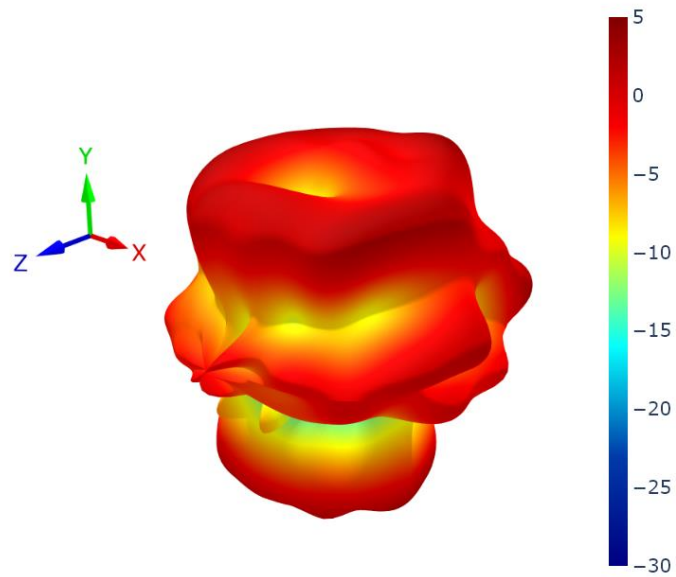

4.43 Bent on a 9x15cm Ground Plane Patterns at 5530 MHz

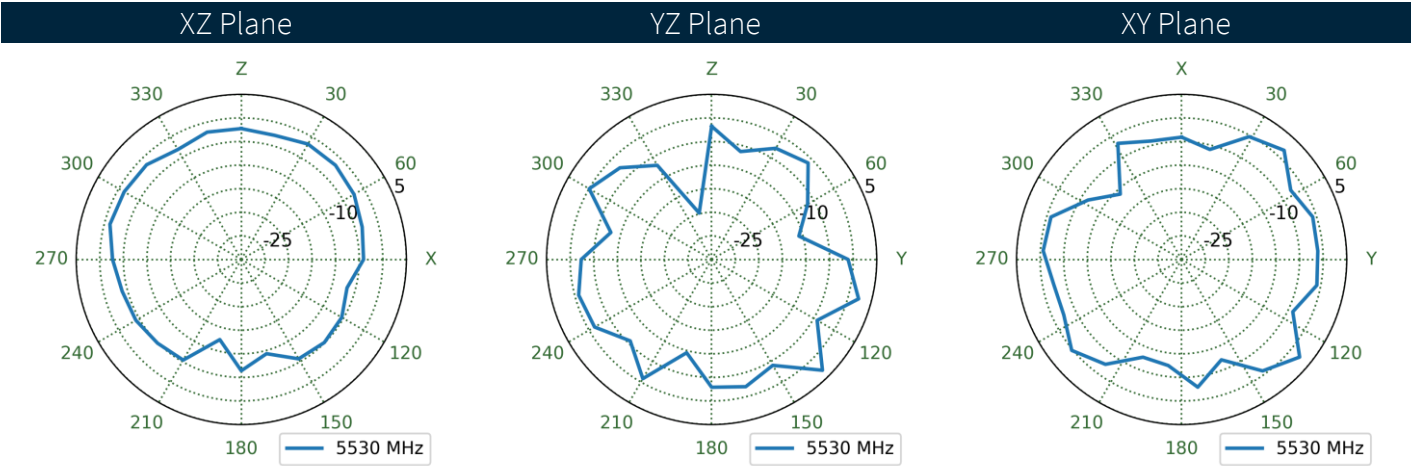
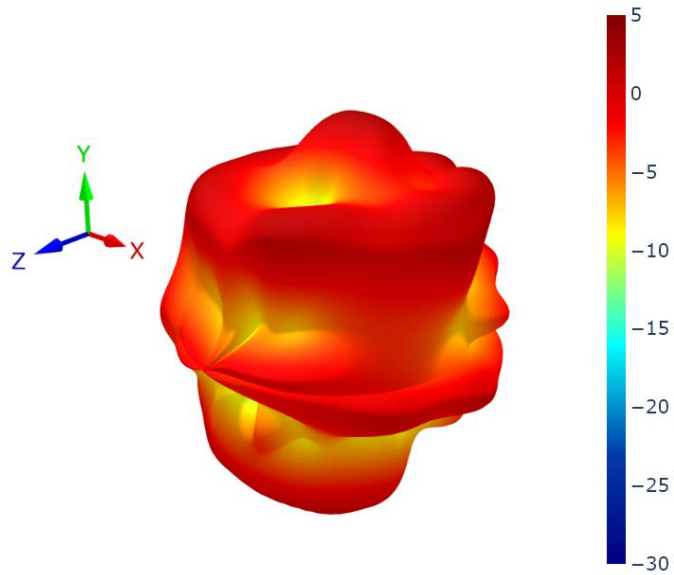

4.44 Straight in Free Space Patterns at 5530 MHz

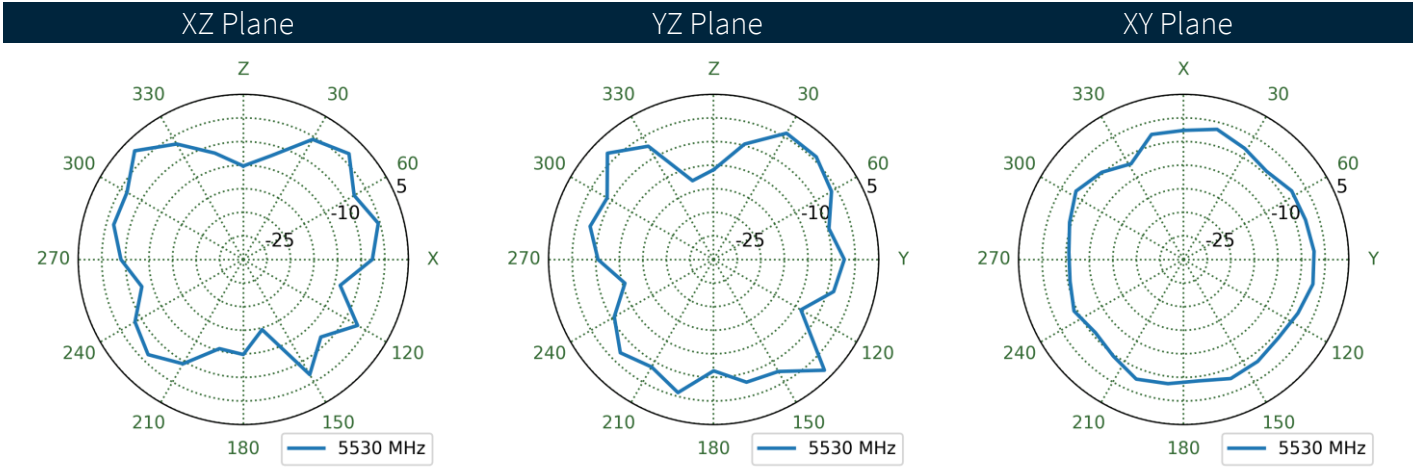
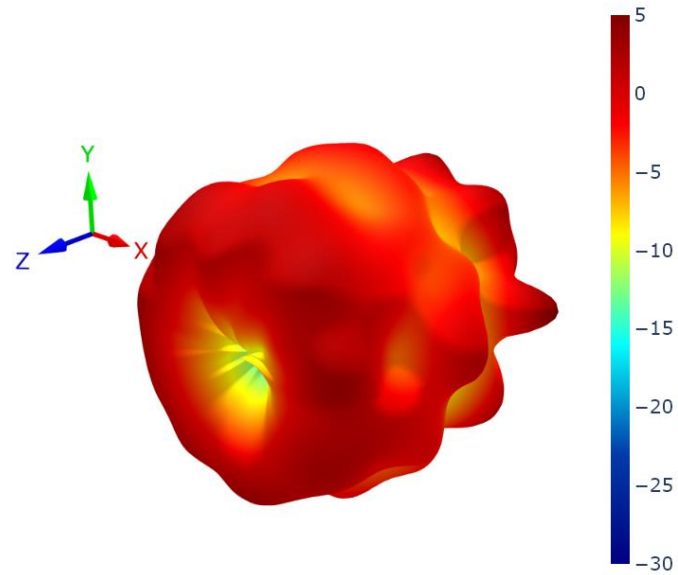

4.45 Straight on a 9x15cm Ground Plane Patterns at 5530 MHz

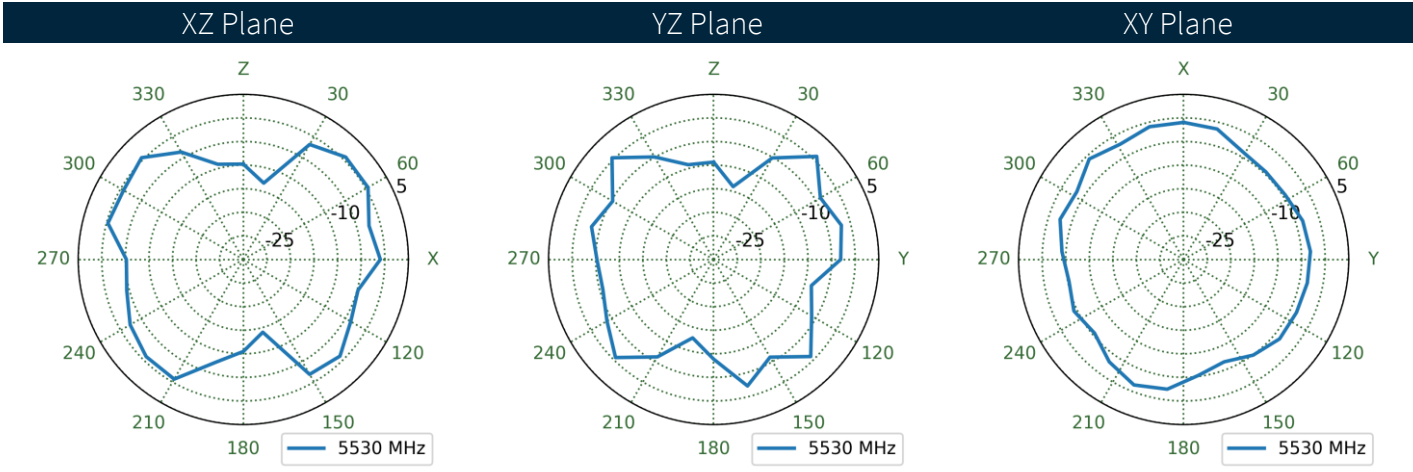
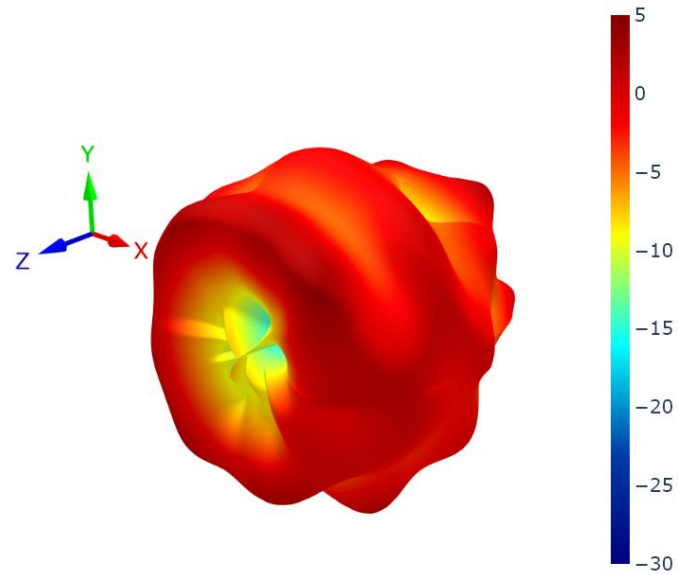

5. Mechanical Drawing

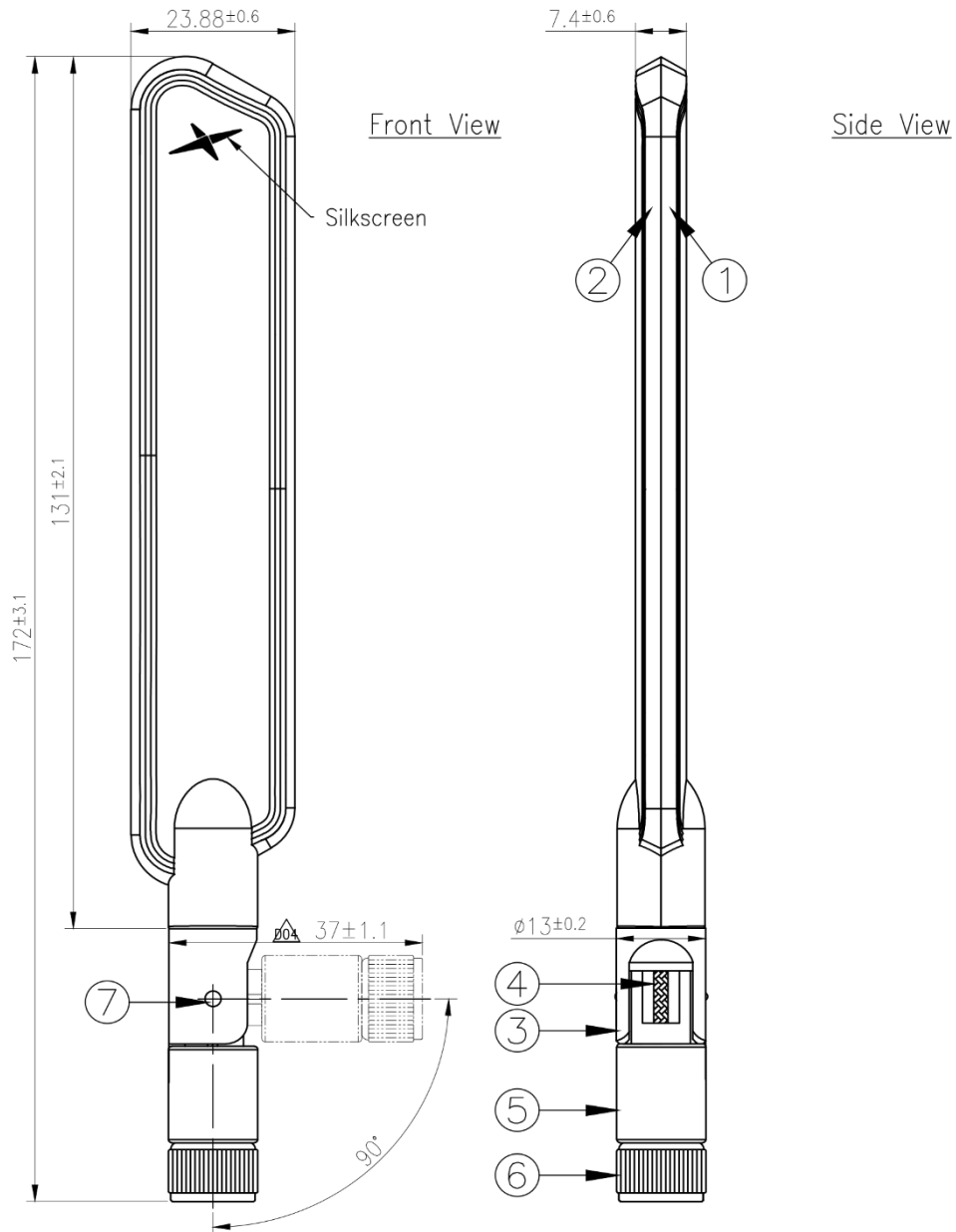

	Name	P/N	Material	Finish	QTY
1	Antenna Housing_Top	001719C060000A	PC+ABS	White	1
2	Antenna Housing_Bottom	001719C060000A	PC+ABS	White	1
3	Upper Base	001719C060000A	PBT+PC	White	1
4	RG178 Coaxial Cable	001719C060000A	FEP	Brown	1
5	Bottom Base	001719C060000A	PBT+PC	White	1
6	SMA(M)ST	001719C060000A	PBT+PC	White	1
7	Rivet	001719C060000A	PBT+PC	White	2

6. Packaging

1pc TG.55.8113W per Small PE Bag
 Dimensions: 30*210mm
 Weight: 31g

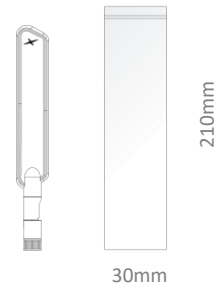

20pcs per Large PE Bag
 Dimensions: 180*265mm
 Weight: 620g

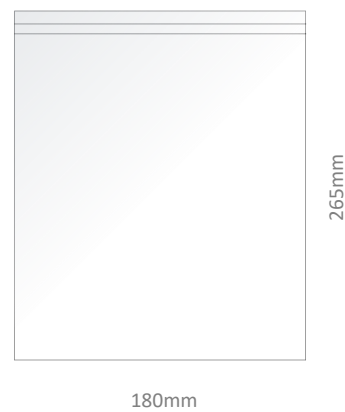

400pcs TG.55.8113W per Carton
 Carton Dimensions: 320*250*230mm
 Weight: 13Kg

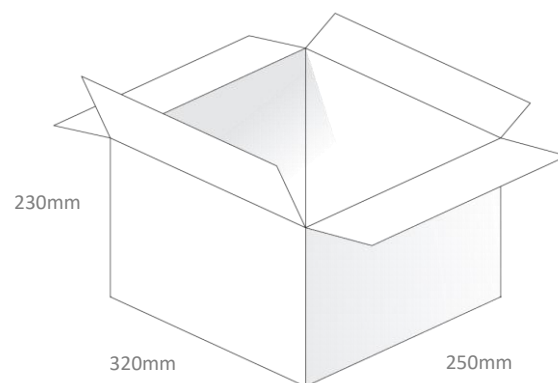

Pallet Dimensions:
 1200*1000*1350mm
 60 Cartons per Pallet
 12 Cartons per layer, 5 Layers

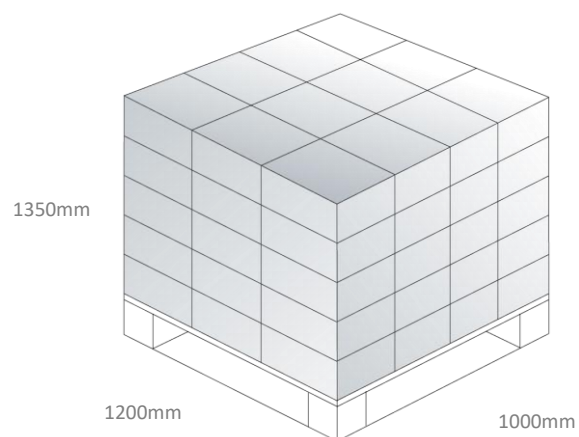

Changelog for the datasheet

SPE-19-8-132 – TG.55.8113W

Revision: B (Current Version)

Date:	2024-02-14
Changes:	Retested antenna and included GPS band extended coverage 1559-1610MHz.
Changes Made by:	Gary West

Previous Revisions

Revision: A (Original First Release)

Date:	2019-05-22
Notes:	Initial Specification Release
Author:	Jack Conroy



www.taoglas.com

